

# ALUBOX

Cassette Postali - Mailboxes

## LISTINO PREZZI 2024



DECORRENZA 15 MARZO 2024

## Indice per Categoria

Categoria	PAG	Categoria	PAG
Casellari Postali per Esterno	3-18	Raccogliposta, Sportelli e Frontali	28
Casellari Postali per Interno	19-20	Raccoglitori per Pubblicità	29
Cassette Postali Singole	21-26	Serie Ottone	31-33
Cassette Postali con Cover Intercambiabile	26	Bacheche Portavvisi e Portachiavi	34-35
Cassette Postali per Citofoni	25	Le cose di Alubox	36
Cassette Portapacchi	27	Ricambi ed Accessori	38-39

## Indice per Serie

Serie	PAG	Serie	PAG
APPENDITUTTO	36	PECHINO	24
BACHECHE PORTA AVVISI	34	PLICOBOX	23
BACHECHE PORTA CHIAVI	35	PORTA SPIRALI ANTIZANZARE	36
BUSTA	21	PORTA OGGETTI LUCCHETTO	36
CAMPANELLI	32	PORTAPACCHI	27
CHALET	23	PORTAPANE	28
CITOFONI	25	POSACENERE	36
COPRIFERITOIA	28	PRIMA	22
CUBO COMPOSTO	19	PULSANTIERE	33
CUBO COMPOSTO RIVISTA	20	QUADRA	23
CUBO RIVISTA	20	RACCOGLIPOSTA	28
DUBLO	22	RACCOGLITORI PUBBLICITÀ	29
EASYBOX	16-18	REGIE POSTE	22
EFFE	21	RESIDENCE	22
ESSE	20	RICAMBI	37
EUROPA	21	RUSTICA	24
FRONTALI DA INCASSO	28	SIRIO	24
IBIZA	22	SLIM	3
JUMBO	19	SOLE	23
JUMBO LUX	4	SPORTELLI DA INCASSO	28
JUMBO FVE / VE verticale	19	TARGA PORTA NUMERI	32
LETTERE	22	TOPOLINO	23
MAGNUM	25	UNO	21
MIA	26	VENERE	24
MODULAR	6-14	VILLA	23
NUMERI CIVICI	32 e 36	X	21

## Casellari Postali CONDOMINIALI Composti da Esterno

**slim** è il casellario postale da esterno adatto ad ogni tipo di installazione. Mantiene tutti i pregi dei nostri casellari postali MODULAR contenendo il prezzo senza rinunciare a un'altissima qualità e ad un'ampia gamma di colorazioni.

**alta qualità e prezzo "sottile"**



**I suoi punti di forza sono:**

- stesso prezzo per tutte le colorazioni disponibili
- 100% MADE IN ITALY
- tenuta all'acqua garantita
- pronta consegna
- grande capacità contenitiva
- rispondente alle normative EN13724
- viene fornito completamente assemblato
- sportello costruito in profilato di alluminio con sistema antiprelievo
- corpo cassetta è interamente verniciato
- rivestimento verniciato alle polveri su entrambi i lati
- nessuna parte del casellario è soggetta alla corrosione, in quanto trattata con vernice alle polveri a processo di lavorazione concluso
- verniciatura alle polveri per esterno ad alta tenuta
- prelievo postale frontale
- composizioni disponibili a 3, 4, 5, 6, 8, 9, 10, 12, 15, 16, 18 e 20 posti



**slim 3x1**  
€ 330,00



**slim 3x2** € 590,00



**slim 3x3** € 890,00

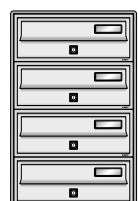

**slim 4x1**  
€ 420,00



**slim 4x2** € 750,00



**slim 4x3** € 1.150,00



**slim 5x1**  
€ 510,00

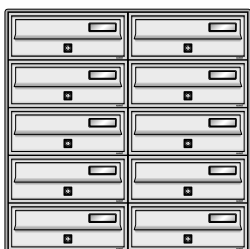

**slim 5x2** € 920,00

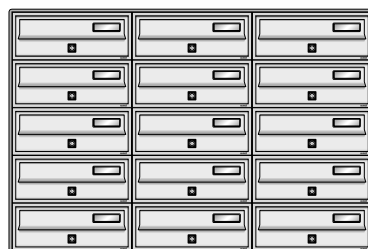

**slim 5x3** € 1.400,00



**slim 4x4** € 1.480,00

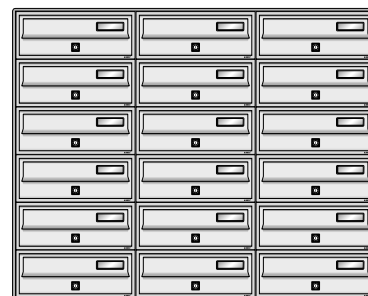

**slim 6x3** € 1.680,00

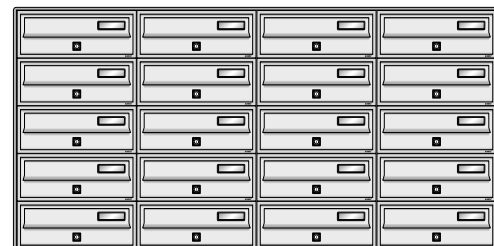

**slim 5x4** € 1.800,00



con il rivestimento verniciato **Argento**

N.B. Cornicette di plastica del corpo cassetta colore argento.

**Sportelli disponibili:**

- Verniciato argento
- Sportello con KIT Pubblicità



con il rivestimento verniciato **Grigio antracite**

N.B. Cornicette di plastica del corpo cassetta sempre colore grigio antracite.

**Sportelli disponibili:**

- Anodizzato ARGENTO
- Anodizzato BRONZO
- Verniciato BIANCO
- Verniciato GRIGIO ANTRACITE
- Verniciato VERDE con elemento mobile Grigio antracite
- Verniciato ROSSO con elemento mobile Grigio antracite
- Verniciato ARGENTO
- Verniciato GRIGIO ANTRACITE con elemento mobile GOLD\*
- Sportello con KIT Pubblicità

\* Versione GOLD: aumentare € 10,00 a sportello

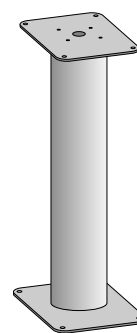

Piantana PICCOLA  
€ 187,00

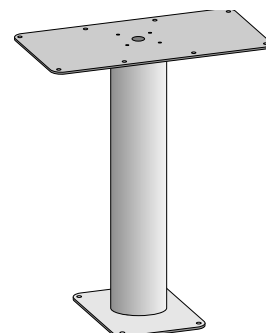

Piantana GRANDE  
€ 207,00

### LEGENDA

ACC = acciaio	ARL = argento liscio Ral 9006	BR = bronzo	GOLD = verniciato ORO	NE = nero Ral 9005	RO = rosso Ral 3003
ALL = alluminio	AV = avorio Ral 1013	CM2 = centimetri quadrati	IX DEC = acciaio inox decorato	OB = ottone brunito	RU = ruggine
AM = argento metallizzato	AZ = azzurro Ral 5015	FE = ferro	IX LI = acciaio inox liscio	OL = ottone lucido	SA = sabbia
AN = anodizzato	BI = bianco Ral 9016	GH = grigio antracite Ral 7016	LZ = lamiera elettrozincata	ORO = colore oro	VE = verde Ral 6005
AR = argento	BRant = bronzo antico	GI = giallo Ral 1003	ML = metro lineare	PF = pressofuso	VR = verniciato

## Prelievo Frontale

**FINO AD  
ESAURIMENTO  
SCORTE**



J05LUX1

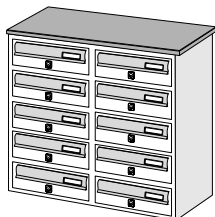

J10LUX1

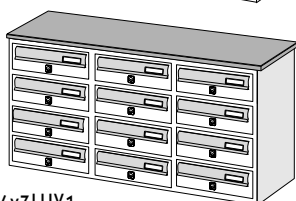

J4x3LUX1

### Serie JUMBO LUX1 ESTERNO

Nome	Materiale	UM	Pez. x conf.	€
J05LUX1*	LZ+ALL AN-AR/BR VR - RO/BI/VE/GH	PZ	1	510,00
J10LUX1*	LZ+ALL AN-AR/BR VR - RO/BI/VE/GH	PZ	1	832,00
J4x3LUX1*	LZ+ALL AN-AR/BR VR - RO/BI/VE/GH	PZ	1	1.027,00

#### Piantane

PIANTANA PICCOLA - H 90	ALL GH	PZ	1	187,00
PIANTANA GRANDE - H 90	ALL GH	PZ	1	207,00

\* **Versione GOLD: aumentare € 10,00 a sportello**

## Prelievo Posteriore

**FINO AD  
ESAURIMENTO  
SCORTE**

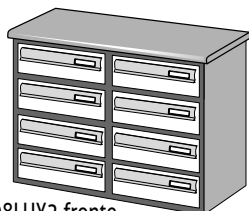

J08LUX2 fronte

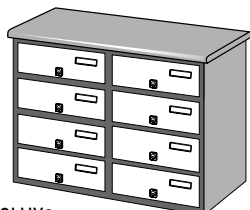

J08LUX2 retro

### Serie JUMBO LUX2 ESTERNO

Nome	Materiale	UM	Pez. x conf.	€
J08LUX2*	LZ+ALL AN-AR/BR VR - RO/BI/VE/GH	PZ	1	859,00
J10LUX2*	LZ+ALL AN-AR/BR VR - RO/BI/VE/GH	PZ	1	1.048,00
J12LUX2*	LZ+ALL AN-AR/BR VR - RO/BI/VE/GH	PZ	1	1.216,00

#### Piantane

PIANTANA PICCOLA - H 90	ALL GH	PZ	1	187,00
PIANTANA GRANDE - H 90	ALL GH	PZ	1	207,00

\* **Versione GOLD: aumentare € 10,00 per ogni sportello frontale**

#### LEGENDA

ACC = acciaio  
ALL = alluminio  
AM = argento metallizzato  
AN = anodizzato  
AR = argento

ARL = argento liscio Ral 9006  
AV = avorio Ral 1013  
AZ = azzurro Ral 5015  
BI = bianco Ral 9016  
BRant = bronzo antico

BR = bronzo  
CM2 = centimetri quadrati  
FE = ferro  
GH = grigio antracite Ral 7016  
GI = giallo Ral 1003

GOLD = verniciato ORO  
IX DEC = acciaio inox decorato  
IX LI = acciaio inox liscio  
LZ = lamiera elettrozincata  
ML = metro lineare

NE = nero Ral 9005  
OB = ottone brunito  
OL = ottone lucido  
ORO = colore oro  
PF = pressofuso

RO = rosso Ral 3003  
RU = ruggine  
SA = sabbia  
VE = verde Ral 6005  
VR = verniciato

Casellari postali CONDOMINIALI COMPONENTI da esterno

# Serie Curve e Modular



**NEW**

Configuratore preventivi online  
[www.preventivi.alubox.it](http://www.preventivi.alubox.it)



Made in Italy

# ALUBOX

MODELLO CONFORME  
NORME EUROPEE  
EN 13724

## Prelievo Frontale

### Serie CURVE 1



CURVE 1 completa

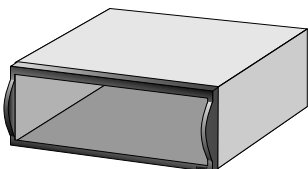

CURVE C1 corpo cassetta



CURVE SP Sportello

Nome	Materiale	UM	Pez. x conf.	€
<b>CURVE 1 completa - Curve C1 + Curve SP1</b>		<b>PZ</b>	<b>6</b>	<b>89,60</b>
<b>CURVE 1 F completa - Curve C1F + Curve SP1</b>		<b>PZ</b>	<b>6</b>	<b>73,00</b>
CURVE C 1	ALL	PZ	6	49,70
CURVE C 1 F	LZ	PZ	6	33,10
MODULAR C1 DOPPIO	ALL	PZ	1	90,00
CURVE SP1	ALL VR GH/RU/AM/BI/RO/VE - AN AR	PZ	6	39,90
CURVE SP1 GOLD	ALL VR GOLD	PZ	1	49,90
CURVE SP2R PUB	ALL VR GH/RU/AM/BI/RO/VE - AN AR	PZ	1	39,90
SP1ACC/BTicino new sfera	ALL VR GH/AM/BI/RO/VE - AN AR	PZ	1	48,50
SP DOPPIO PUB	ALL VR GH/AM/BI/RO/VE - AN AR	PZ	1	71,00

### Serie MODULAR 1



MODULAR 1 completa

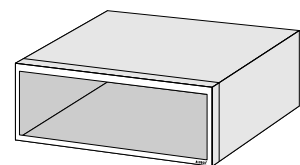

MODULAR C1 corpo cassetta



SP1 Sportello

SP1 ACC  
Sportello porta accessori

Nome	Materiale	UM	Pez. x conf.	€
<b>MODULAR 1 completa - Modular C1+SP1 (corpo+sportello)</b>		<b>PZ</b>	<b>6</b>	<b>81,50</b>
<b>MODULAR 1 F completa - Modular C1F+SP1 (corpo+sportello)</b>		<b>PZ</b>	<b>6</b>	<b>69,80</b>
MODULAR C 1	ALL	PZ	6	44,80
MODULAR C 1 F	LZ	PZ	6	33,10
MODULAR C1 DOPPIO	ALL	PZ	1	90,00
SP1	ALL VR GH/AM/BI/RO/VE - AN AR/BR	PZ	6	36,70
SP1 GOLD	ELEM. MOB. VR GOLD	PZ	1	46,70
SP1ACC/BTicino new sfera	ALL VR GH/AM/BI/RO/VE - AN AR/BR	PZ	1	48,50
SP DOPPIO PUB	ALL VR GH/AM/BI/RO/VE - AN AR/BR	PZ	1	71,00
AM1- Kit antivandalo	-	PZ	1	23,20

#### LEGENDA

ACC = acciaio  
ALL = alluminio  
AM = argento metallizzato  
AN = anodizzato  
AR = argento

ARL = argento liscio Ral 9006  
AV = avorio Ral 1013  
AZ = azzurro Ral 5015  
BI = bianco Ral 9016  
BRant = bronzo antico

BR = bronzo  
CM2 = centimetri quadrati  
FE = ferro  
GH = grigio antracite Ral 7016  
GI = giallo Ral 1003

GOLD = verniciato ORO  
IX DEC = acciaio inox decorato  
IX LI = acciaio inox liscio  
LZ = lamiera elettrozincata  
ML = metro lineare

NE = nero Ral 9005  
OB = ottone brunito  
OL = ottone lucido  
ORO = colore oro  
PF = pressofuso

RO = rosso Ral 3003  
RU = ruggine  
SA = sabbia  
VE = verde Ral 6005  
VR = verniciato



MODULAR 200/1 completa

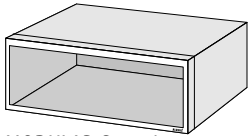

MODULAR C 200/1 corpo cassetta



SP1 Sportello

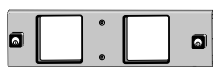

SP1 ACC - Sportello porta accessori

### Serie MODULAR 200/1 (solo da incasso con cornice)

Nome	Materiale	UM	Pez. x conf.	€
<b>Profondità corpo cassetta cm 20</b>				
<b>MODULAR C200/1 completa</b>	<b>Modular C200/1+SP1 (corpo+sportello)</b>	<b>PZ</b>	<b>6</b>	<b>85,20</b>
MODULAR C200/1	ALL	PZ	6	48,50
SP1	ALL VR GH/AM/BI/RO/VE - AN AR/BR	PZ	6	36,70
SP1 GOLD	ELEM. MOB. VR GOLD	PZ	1	46,70
SP1ACC/BTicino new sfera	ALL VR GH/AM/BI/RO/VE - AN AR/BR	PZ	1	48,50
AM1- Kit antivandalo	-	PZ	1	23,20

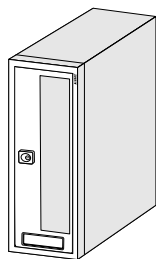

MODULAR 1V completa

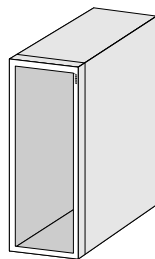

MODULAR C 1V corpo cassetta



SP1V Sportello

### Serie MODULAR 1 Verticale

Nome	Materiale	UM	Pez. x conf.	€
<b>MODULAR 1V completa</b>	<b>Modular C1V+SP1V (corpo+sportello)</b>	<b>PZ</b>	<b>6</b>	<b>81,50</b>
<b>MODULAR 1V F completa</b>	<b>Modular C1VF+SP1V (corpo+sportello)</b>	<b>PZ</b>	<b>6</b>	<b>69,80</b>
MODULAR C 1	ALL	PZ	6	44,80
MODULAR C 1 F	LZ	PZ	6	33,10
MODULAR C1 DOPPIO	ALL	PZ	1	90,00
SP1V	ALL VR GH/BI/RO/VE - AN AR/BR	PZ	6	36,70
SP DOPPIO PUB	ALL VR GH/AM/BI/RO/VE - AN AR/BR	PZ	1	71,00

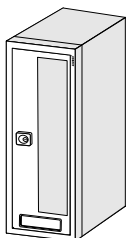

MODULAR 200/1V completa

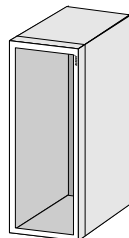

MODULAR C 200/1V corpo cassetta



SP1V Sportello

### Serie MODULAR 200/1 Verticale (solo da incasso con cornice)

Nome	Materiale	UM	Pez. x conf.	€
<b>Profondità corpo cassetta cm 20</b>				
<b>MODULAR C200/1V completa</b>	<b>Modular C200/1V+SP1V (corpo+sportello)</b>	<b>PZ</b>	<b>6</b>	<b>85,20</b>
MODULAR C 200/1	ALL	PZ	6	48,50
SP1V	ALL VR GH/BI/RO/VE - AN AR/BR	PZ	6	36,70

LEGENDA	ACC = acciaio	ALL = alluminio	AM = argento metallizzato	AN = anodizzato	AR = argento	ARL = argento liscio Ral 9006	AV = avorio Ral 1013	AZ = azzurro Ral 5015	BI = bianco Ral 9016	BRant = bronzo antico	BR = bronzo	CM2 = centimetri quadrati	FE = ferro	GH = grigio antracite Ral 7016	GI = giallo Ral 1003	GOLD = verniciato ORO	IX DEC = acciaio inox decorato	IX LI = acciaio inox liscio	LZ = lamiera elettrozincata	ML = metro lineare	NE = nero Ral 9005	OB = ottone brunito	OL = ottone lucido	ORO = colore oro	PF = pressofuso	RO = rosso Ral 3003	RU = ruggine	SA = sabbia	VE = verde Ral 6005	VR = verniciato
---------	---------------	-----------------	---------------------------	-----------------	--------------	-------------------------------	----------------------	-----------------------	----------------------	-----------------------	-------------	---------------------------	------------	--------------------------------	----------------------	-----------------------	--------------------------------	-----------------------------	-----------------------------	--------------------	--------------------	---------------------	--------------------	------------------	-----------------	---------------------	--------------	-------------	---------------------	-----------------

## Prelievo Frontale



MODULAR 270 completa

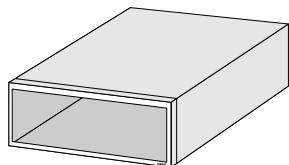

MODULAR 270 corpo cassetta



SP1/270 Sportello

### Serie MODULAR 270

Nome	Materiale	UM	Pez. x conf.	€
<b>MODULAR 270 completa - Modular C 270+SP1/270 (corpo+sportello)</b>		<b>PZ</b>	<b>6</b>	<b>81,50</b>
<b>MODULAR 270F completa - Modular C 270+SP1/270 (corpo+sportello)</b>		<b>PZ</b>	<b>6</b>	<b>69,80</b>
MODULAR C 270	ALL	PZ	6	44,80
MODULAR C 270F	LZ	PZ	6	33,10
MODULAR C270 DOPPIO	ALL	PZ	1	90,10
SP1270	ALL VR GH/BI/RO/VE - AN AR/BR	PZ	6	36,70
SP1270 OTT	ELEM. MOB. OTTONE/GH	PZ	1	71,00
SP1 GOLD	ELEM. MOB. VR GOLD	PZ	1	46,70
SP 270 DOPPIO PUB	ALL VR GH/BI/RO/VE - AN AR/BR	PZ	1	71,00
SP 270/2R singolo PUB	ALL VR GH/BI/RO/VE - AN AR/BR	PZ	1	36,70



MODULAR 240/1 completa

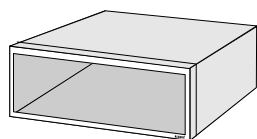

MODULAR C 240/1 corpo cassetta



SP1/270 Sportello

### Serie MODULAR 240/1 (solo da incasso con cornice)

Nome	Materiale	UM	Pez. x conf.	€
<b>Profondità corpo cassetta cm 24</b>				
<b>MODULAR C240/1 - Modular C 240/1+SP1/270 (corpo+sportello)</b>		<b>PZ</b>	<b>6</b>	<b>85,20</b>
MODULAR C 240/1	ALL	PZ	6	48,50
SP1270	ALL VR GH/BI/RO/VE - AN AR/BR	PZ	6	36,70
SP1270 OTT	ELEM. MOB. OTTONE/GH	PZ	1	71,00
SP1 GOLD	ELEM. MOB. VR GOLD	PZ	1	46,70
SP 270/2R singolo PUB	ALL VR GH/BI/RO/VE - AN AR/BR	PZ	1	36,70

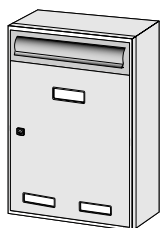

MODULAR 3 completa

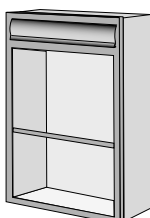

MODULAR C3 corpo cassetta

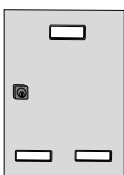

SP3

### Serie MODULAR 3

Nome	Materiale	UM	Pez. x conf.	€
<b>MODULAR 3 completa - Modular C 3 + SP3 (corpo+sportello)</b>		<b>PZ</b>	<b>6</b>	<b>88,30</b>
MODULAR C 3	ALL	PZ	6	63,20
SP3	ALL VR GH/BI/RO/VE - AN AR/BR	PZ	6	25,10
SP3RMJB PUB	ALL VR GH/BI/RO/VE - AN AR/BR	PZ	1	31,40
AM3 Kit antivandalo	-	PZ	1	23,20



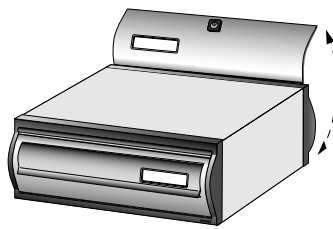

CURVE 2 Completa

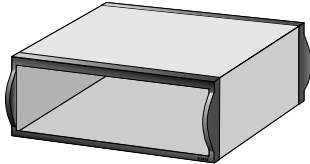

CURVE C2 corpo cassetta



CURVE SP2 F Frontale



CURVE SP2 R Retro

### Serie CURVE 2

Nome	Materiale	UM	Pez. x conf.	€
<b>CURVE 2 completa - Curve C2+Curve SP2F+Curve SP2R (corpo+sportelli)</b>		<b>PZ</b>	<b>6</b>	<b>117,70</b>
<b>CURVE 2 F completa - Curve C2F+Curve SP2F+Curve SP2R (corpo+sportelli)</b>		<b>PZ</b>	<b>6</b>	<b>101,10</b>
CURVE C 2	ALL	PZ	6	53,40
CURVE C 2 F	LZ	PZ	6	36,80
MODULAR C 2 DOPPIO	ALL	PZ	1	97,50
CURVE SP2 F	ALL VR GH/RU/AM/BI/RO/VE - AN AR	PZ	6	33,70
CURVE SP2 F GOLD	ELEM. MOB. VR GOLD	PZ	1	43,70
CURVE SP2 R	ALL VR GH/RU/AM/BI/RO/VE - AN AR	PZ	6	30,60
CURVE SP2R PUB	ALL VR GH/RU/AM/BI/RO/VE - AN AR	PZ	1	39,90
SP DOPPIO PUB	ALL VR GH/AM/BI/RO/VE - AN AR	PZ	1	71,00
SP2R singolo PUB	ALL VR GH/AM/BI/RO/VE - AN AR	PZ	1	36,70

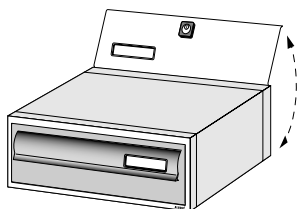

MODULAR 2 completa

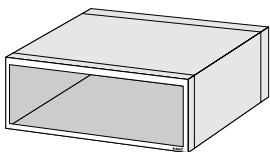

MODULAR C2 corpo cassetta



SP2 F Frontale



SP2 R Retro

### Serie MODULAR 2

Nome	Materiale	UM	Pez. x conf.	€
<b>MODULAR 2 completa - Modular C2+SP2F+SP2R (corpo+sportelli)</b>		<b>PZ</b>	<b>6</b>	<b>107,80</b>
<b>MODULAR 2 F completa - Modular C2F+SP2F+SP2R (corpo+sportelli)</b>		<b>PZ</b>	<b>6</b>	<b>95,00</b>
MODULAR C 2	ALL	PZ	6	48,50
MODULAR C 2 F	LZ	PZ	6	35,70
MODULAR C 2 DOPPIO	ALL	PZ	1	97,50
SP2 F	ALL VR GH/AM/BI/RO/VE - AN AR/BR	PZ	6	31,20
SP2 F GOLD	ELEM. MOB. VR GOLD	PZ	1	41,20
SP2 R	ALL VR GH/AM/BI/RO/VE - AN AR/BR	PZ	6	28,10
SP DOPPIO PUB	ALL VR GH/AM/BI/RO/VE - AN AR/BR	PZ	1	71,00
SP2R singolo PUB	ALL VR GH/AM/BI/RO/VE - AN AR/BR	PZ	1	36,70
AM1- Kit antivandalo	-	PZ	1	23,20

#### LEGENDA

ACC = acciaio  
ALL = alluminio  
AM = argento metallizzato  
AN = anodizzato  
AR = argento

ARL = argento liscio Ral 9006  
AV = avorio Ral 1013  
AZ = azzurro Ral 5015  
BI = bianco Ral 9016  
BRant = bronzo antico

BR = bronzo  
CM2 = centimetri quadrati  
FE = ferro  
GH = grigio antracite Ral 7016  
GI = giallo Ral 1003

GOLD = verniciato ORO  
IX DEC = acciaio inox decorato  
IX LI = acciaio inox liscio  
LZ = lamiera elettrozincata  
ML = metro lineare

NE = nero Ral 9005  
OB = ottone brunito  
OL = ottone lucido  
ORO = colore oro  
PF = pressofuso

RO = rosso Ral 3003  
RU = ruggine  
SA = sabbia  
VE = verde Ral 6005  
VR = verniciato

## Prelievo Posteriore



MODULAR 200/2 completa

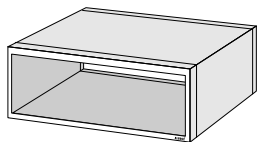

MODULAR C 200/2 corpo cassetta

SP2 F  
FrontaleSP2 R  
Retro

### Serie MODULAR 200/2 (solo da incasso con cornice)

Nome	Materiale	UM	Pez. x conf.	€
<b>Profondità corpo cassetta cm 20</b>				
<b>MODULAR C200/2 completa - Modular C200/2+SP2F+SP2R (corpo+sportelli)</b>		<b>PZ</b>	<b>6</b>	<b>107,80</b>
MODULAR C 200/2	ALL	PZ	6	48,50
SP2 F	ALL VR GH/AM/BI/RO/VE - AN AR/BR	PZ	6	31,20
SP2 F GOLD	ELEM. MOB. VR GOLD	PZ	1	41,20
SP2 R	ALL VR GH/AM/BI/RO/VE - AN AR/BR	PZ	6	28,10
SP2R singolo PUB	ALL VR GH/AM/BI/RO/VE - AN AR/BR	PZ	1	36,70
AM1- Kit antivandalo	-	PZ	1	23,20

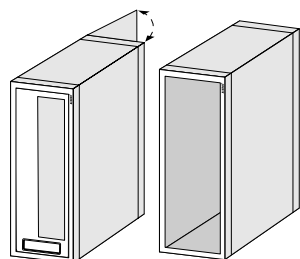
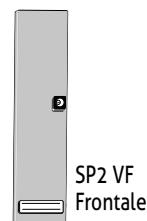
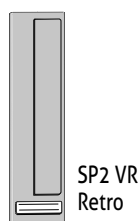
MODULAR 2V  
completaMODULAR C 2V  
corpo cassettaSP2 VF  
FrontaleSP2 VR  
Retro

### Serie MODULAR 2 Verticale

Nome	Materiale	UM	Pez. x conf.	€
<b>Profondità corpo cassetta cm 20</b>				
<b>MODULAR 2V completa - Modular C2+SP2VF+SP2VR (corpo+sportelli)</b>		<b>PZ</b>	<b>6</b>	<b>107,80</b>
<b>MODULAR 2VF completa - Modular C2F+SP2VF+SP2VR (corpo+sportelli)</b>		<b>PZ</b>	<b>6</b>	<b>95,00</b>
MODULAR C 2	ALL	PZ	6	48,50
MODULAR C 2 F	LZ	PZ	6	35,70
MODULAR C 2 DOPPIO	ALL	PZ	1	97,50
SP2 V F	ALL VR GH/BI/RO/VE - AN AR/BR	PZ	6	31,20
SP2 V R	ALL VR GH/BI/RO/VE - AN AR/BR	PZ	6	28,10
SP DOPPIO PUB	ALL VR GH/AM/BI/RO/VE - AN AR/BR	PZ	1	71,00

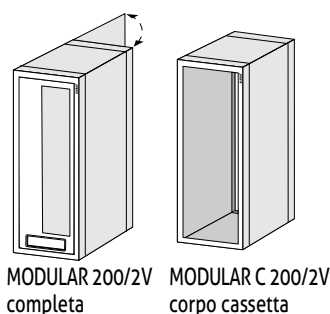
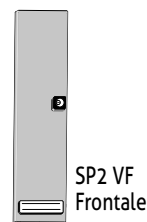
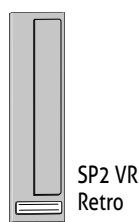
MODULAR 200/2V  
completaMODULAR C 200/2V  
corpo cassettaSP2 VF  
FrontaleSP2 VR  
Retro

### Serie MODULAR 200/2 Verticale (solo da incasso con cornice)

Nome	Materiale	UM	Pez. x conf.	€
<b>Profondità corpo cassetta cm 20</b>				
<b>MODULAR 200/2 V completa - Modular C200/2V+SP2VF+SP2VR (corpo+sportelli)</b>		<b>PZ</b>	<b>6</b>	<b>107,80</b>
MODULAR C 2	ALL	PZ	6	48,50
SP2 V F	ALL VR GH/BI/RO/VE - AN AR/BR	PZ	6	31,20
SP2 V R	ALL VR GH/BI/RO/VE - AN AR/BR	PZ	6	28,10
SP2RV singolo PUB	ALL VR GH/AM/BI/RO/VE - AN AR/BR	PZ	1	36,70

#### LEGENDA

ACC = acciaio  
ALL = alluminio  
AM = argento metallizzato  
AN = anodizzato  
AR = argento

ARL = argento liscio Ral 9006  
AV = avorio Ral 1013  
AZ = azzurro Ral 5015  
BI = bianco Ral 9016  
BRant = bronzo antico

BR = bronzo  
CM2 = centimetri quadrati  
FE = ferro  
GH = grigio antracite Ral 7016  
GI = giallo Ral 1003

GOLD = verniciato ORO  
IX DEC = acciaio inox decorato  
IX LI = acciaio inox liscio  
LZ = lamiera elettrozincata  
ML = metro lineare

NE = nero Ral 9005  
OB = ottone brunito  
OL = ottone lucido  
ORO = colore oro  
PF = pressofuso

RO = rosso Ral 3003  
RU = ruggine  
SA = sabbia  
VE = verde Ral 6005  
VR = verniciato

## Prelievo Posteriore

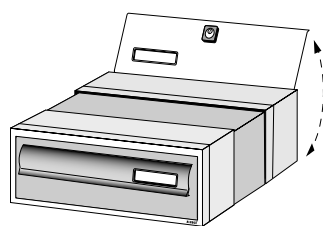

MODULAR 2T completa

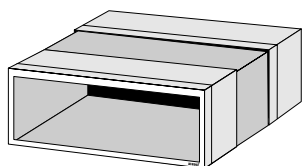

MODULAR C2 T corpo cassetta



SP2 F Frontale



SP2 R Retro



SP2 VF Frontale



SP2 VR Retro

Cassetta bifrontale da incasso con corpo a profondità variabile: da un minimo di cm 27,5 a un massimo di cm 43 di spessore del muro.

### Serie MODULAR 2T (solo da incasso con cornice)

Nome	Materiale	UM	Pez. x conf.	€
<b>MODULAR 2 T completa - Modular C 2T+SP2F+SP2R (corpo+sportelli)</b>				
MODULAR C 2 T	LZ	PZ	6	84,10
SP2 F	ALL VR GH/AM/BI/RO/VE - AN AR/BR	PZ	6	31,20
SP2 F GOLD	ELEM. MOB. VR GOLD	PZ	1	41,20
SP2 R	ALL VR GH/AM/BI/RO/VE - AN AR/BR	PZ	6	28,10
SP2 V F	ALL VR GH/BI/RO/VE - AN AR/BR	PZ	6	31,20
SP2 V R	ALL VR GH/BI/RO/VE - AN AR/BR	PZ	6	28,10
SP2R singolo PUB	ALL VR GH/AM/BI/RO/VE - AN AR/BR	PZ	1	36,70
AM1- Kit antivandalo	-	PZ	1	23,20

### Serie MODULAR 270/2

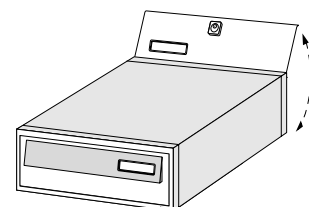

MODULAR 270/2 completa

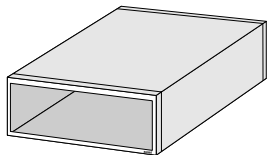

MODULAR C270/2 corpo cassetta



SP2 F /270 Frontale



SP2 R /270 Retro

Nome	Materiale	UM	Pez. x conf.	€
<b>MODULAR 270-2 completa - Modular C 270/2+SP2 F/270+SP2 R/270</b>				
<b>MODULAR 270-2F completa - Modular C 270/2+SP2 F/270+SP2 R/270</b>				
MODULAR C 270-2	ALL	PZ	6	48,50
MODULAR C 270-2F	LZ	PZ	6	35,70
MODULAR C270-2 DOPPIO	ALL	PZ	1	97,50
SP2 F 270	ALL VR GH/BI/RO/VE - AN AR/BR	PZ	6	31,20
SP2 F 270 GOLD	ELEM. MOB. VR GOLD	PZ	1	41,20
SP2 F 270 OTT	ELEM. MOB. OTTONE/GH	PZ	1	65,50
SP2 R 270	ALL VR GH/BI/RO/VE - AN AR/BR	PZ	6	28,10
SP 270 DOPPIO PUB	ALL VR GH/BI/RO/VE - AN AR/BR	PZ	1	71,00
SP 270/2R singolo PUB	ALL VR GH/BI/RO/VE - AN AR/BR	PZ	1	36,70

#### LEGENDA

ACC = acciaio  
ALL = alluminio  
AM = argento metallizzato  
AN = anodizzato  
AR = argento

ARL = argento liscio Ral 9006  
AV = avorio Ral 1013  
AZ = azzurro Ral 5015  
BI = bianco Ral 9016  
BRant = bronzo antico

BR = bronzo  
CM2 = centimetri quadrati  
FE = ferro  
GH = grigio antracite Ral 7016  
GI = giallo Ral 1003

GOLD = verniciato ORO  
IX DEC = acciaio inox decorato  
IX LI = acciaio inox liscio  
LZ = lamiera elettrozincata  
ML = metro lineare

NE = nero Ral 9005  
OB = ottone brunito  
OL = ottone lucido  
ORO = colore oro  
PF = pressofuso

RO = rosso Ral 3003  
RU = ruggine  
SA = sabbia  
VE = verde Ral 6005  
VR = verniciato

## Prelievo Posteriore

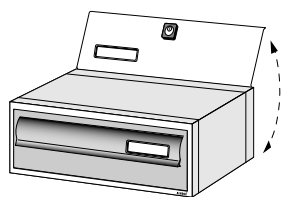

MODULAR 240/2 completa

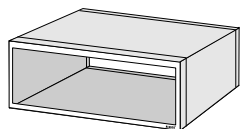

MODULAR C240/2 corpo cassetta



SP2 F /270 Frontale



SP2 R /270 Retro

### Serie MODULAR 240/2 (solo da incasso con cornice)

Nome	Materiale	UM	Pez. x conf.	€
<b>Profondità corpo cassetta cm 24</b>				
<b>MODULAR 240/2 completa - Modular C240/2+SP2F270+SP2R270 (corpo+sportello)</b>				
MODULAR C 240/2	ALL	PZ	6	48,50
SP2 F 270	ALL VR GH/BI/RO/VE - AN AR/BR	PZ	6	31,20
SP2 F 270 GOLD	ELEM. MOB. VR GOLD	PZ	1	41,20
SP2 F 270 OTT	ELEM. MOB. OTTONE/GH	PZ	1	65,50
SP2 R 270	ALL VR GH/BI/RO/VE - AN AR/BR	PZ	6	28,10
SP 270/2R singolo PUB	ALL VR GH/BI/RO/VE - AN AR/BR	PZ	1	36,70

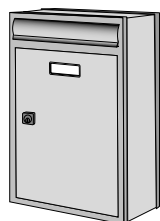

MODULAR 3/2 completa

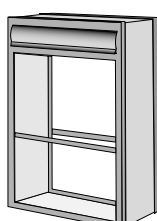

MODULAR C3/2 corpo cassetta

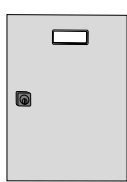

SP3 Sportello fronte

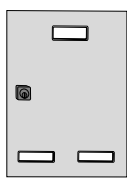

SP3R Sportello retro

### Serie MODULAR 3/2

Nome	Materiale	UM	Pez. x conf.	€
<b>MODULAR 3/2 completa - Modular C 3/2 + SP3 + SP3/R</b>				
MODULAR C 3/2	ALL	PZ	1	65,50
SP3	ALL VR GH/BI/RO/VE - AN AR/BR	PZ	6	25,10
SP3R	ALL VR GH/BI/RO/VE - AN AR/BR	PZ	6	25,10
SP3RMJB PUB	ALL VR GH/BI/RO/VE - AN AR/BR	PZ	1	31,40
AM3 Kit antivandalo	-	PZ	1	23,20

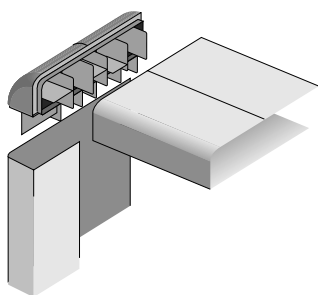

## Rivestimenti per Serie MODULAR

Nome	Materiale	UM	Pez. x conf.	€
RIVEST. per MODULAR 1 e 2	ALL AN VR	ML	-	131,46
RIVEST. per MODULAR 270	ALL AN VR	ML	-	171,73
RIVEST. per MODULAR 270/2	ALL AN VR	ML	-	212,00
RIVEST. per MODULAR 3	ALL AN VR	ML	-	65,73
BARRA RIVEST. - 3 mt (prof. 15 cm)	ALL AN VR	-	-	197,20
BARRA RIVEST. - 3 mt (prof. 20 cm)	ALL AN VR	-	-	318,00

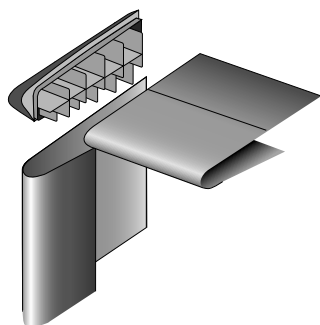

## Rivestimenti per Serie CURVE

Nome	Materiale	UM	Pez. x conf.	€
RIVEST. per CURVE 1 e 2	ALL AN VR	ML	-	131,46
BARRA RIVEST. - 3 mt (prof.15 cm)	ALL AN VR	-	-	197,20

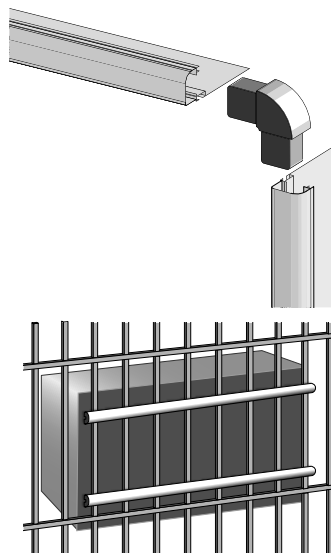

Traversini

## Cornice e fondale per Serie MODULAR e Serie CURVE

Nome	Materiale	UM	Pez. x conf.	€
CORNICE	ALL VR GH/BI - AN AR	ML	-	33,70
FONDALE per BLOCCHIERE	ALL VR GH/BI - AN AR	CM2	-	0,015
BARRA CORNICE 3 mt	ALL VR GH/BI - AN AR	ML	-	101,10

TRAVERSINI fissaggio casellario a cancellata a preventivo

## SUPPLEMENTO COLORI RAL

+35% parti verniciate

### LEGENDA

ACC = acciaio	ARL = argento liscio Ral 9006	BR = bronzo	GOLD = verniciato ORO	NE = nero Ral 9005	RO = rosso Ral 3003
ALL = alluminio	AV = avorio Ral 1013	CM2 = centimetri quadrati	IX DEC = acciaio inox decorato	OB = ottone brunito	RU = ruggine
AM = argento metallizzato	AZ = azzurro Ral 5015	FE = ferro	IX LI = acciaio inox liscio	OL = ottone lucido	SA = sabbia
AN = anodizzato	BI = bianco Ral 9016	GH = grigio antracite Ral 7016	LZ = lamiera elettrozincata	ORO = colore oro	VE = verde Ral 6005
AR = argento	BRant = bronzo antico	GI = giallo Ral 1003	ML = metro lineare	PF = pressofuso	VR = verniciato

## Piantane per Serie CURVE

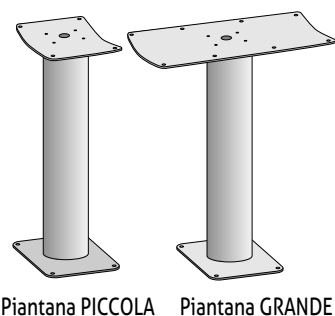

Piantana PICCOLA Piantana GRANDE

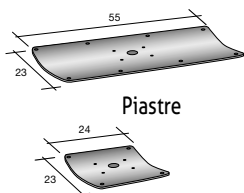

Piastra

Nome	Materiale	UM	Pez. x conf.	€
* PIANTANA PICCOLA - H 90	ALL VR GH/AM/BI	PZ	1	187,00
* PIANTANA GRANDE - H 90	ALL VR GH/AM/BI	PZ	1	207,00
* PIANTANE LATERALI - H 167	ALL VR GH/AM/BI	PZ	coppia	320,00
PIASTRA GRANDE sup. 23x55	ACC VR GH/AM/BI	PZ	1	58,90
PIASTRA PICCOLA sup. 23x24	ACC VR GH/AM/BI	PZ	1	39,90
PIASTRA BASE 30x30	ACC VR GH/AM/BI	PZ	1	45,90

\* Supplemento H superiore + 138,00

\* Supplemento H inferiore + 42,50

## Piantane per Serie Modular

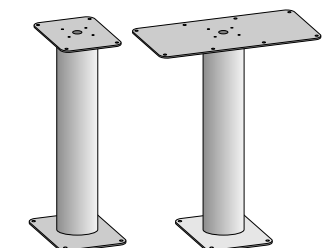

Piantana PICCOLA Piantana GRANDE

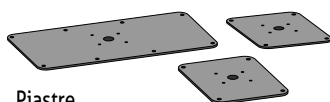

Piastra

Nome	Materiale	UM	Pez. x conf.	€
* PIANTANA PICCOLA - H 90	ALL VR GH/AM/BI	PZ	1	187,00
* PIANTANA GRANDE - H 90	ALL VR GH/AM/BI	PZ	1	207,00
* PIANTANA per MOD.3	ALL VR GH/AM/BI	PZ	1	187,00
PIASTRA GRANDE sup. 23x55	ACC VR GH/AM/BI	PZ	1	58,90
PIASTRA PICCOLA sup. 23x24	ACC VR GH/AM/BI	PZ	1	39,90
PIASTRA BASE 30x30	ACC VR GH/AM/BI	PZ	1	45,90
* Piantane laterali	ALL VR GH/AM/BI	PZ	coppia	320,00
Supporto per piantane laterali (c)	ALL VR GH/AM/BI		a preventivo	
Prolungamento rivestimento Modular	ALL VR GH/AM/BI		a preventivo	

\* Supplemento H superiore + 138,00

\* Supplemento H inferiore + 42,50

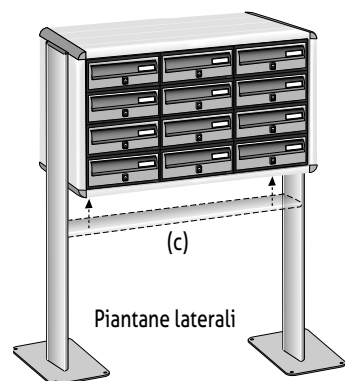

Piantane laterali

## Assemblaggi-Imballi Serie Modular e Curve

Nome	€
Assemblaggio blocchiere (prezzi di listino a cassetta) con rivestimento	17,00 listino
Assemblaggio blocchiere (prezzi di listino a cassetta) con cornice	10,40 listino
Assemblaggio su piantane laterali	+ 110,00 listino
Imballi speciali Serie Modular e Serie Curve	a preventivo

### LEGENDA

ACC = acciaio  
ALL = alluminio  
AM = argento metallizzato  
AN = anodizzato  
AR = argento

ARL = argento liscio Ral 9006  
AV = avorio Ral 1013  
AZ = azzurro Ral 5015  
BI = bianco Ral 9016  
BRant = bronzo antico

BR = bronzo  
CM2 = centimetri quadrati  
FE = ferro  
GH = grigio antracite Ral 7016  
GI = giallo Ral 1003

GOLD = verniciato ORO  
IX DEC = acciaio inox decorato  
IX LI = acciaio inox liscio  
LZ = lamiera elettrozincata  
ML = metro lineare

NE = nero Ral 9005  
OB = ottone brunito  
OL = ottone lucido  
ORO = colore oro  
PF = pressofuso

RO = rosso Ral 3003  
RU = ruggine  
SA = sabbia  
VE = verde Ral 6005  
VR = verniciato

Casellari postali CONDOMINIALI COMPONENTI da esterno

Serie

**EASY  
BOX**



# Casellari Postali da Esterno EasyBox con VANO PORTAPACCHI

## Serie EasyBox per composizione casellari

Nome	Materiale	UM	Pez. x conf.	€
EasyBox400 esterno-interno (vano pacchi con serratura PBlock)	LZ - VR	PZ	1	195,00
EasyBox400 esterno-interno (vano pacchi con calamita)	LZ - VR	PZ	1	187,00
EasyBox300 esterno-interno (vano pacchi con serratura PBlock)	LZ - VR	PZ	1	195,00
EasyBox300 esterno-interno (vano pacchi con calamita)	LZ - VR	PZ	1	187,00
EasyBox400 VANO UNICO (con calamita)	LZ - VR	PZ	1	137,80
EasyBox300 VANO UNICO (con calamita)	LZ - VR	PZ	1	137,80



EasyBox400



EasyBox300



Vano UNICO EasyBox400



Vano UNICO EasyBox300

## Rivestimenti Easy

Nome	Materiale	UM	Pez. x conf.	€
Top EASY 400 da 1 colonna	ACC VR	PZ	-	27,00
Top EASY 400 da 2 colonne	ACC VR	PZ	-	40,30
Top EASY 400 da 3 colonne	ACC VR	PZ	-	60,40
Top EASY 400 da 4 colonne	ACC VR	PZ	-	82,70
Top EASY 400 da 5 colonne	ACC VR	PZ	-	129,30
Top EASY 400 da 6 colonne	ACC VR	PZ	-	137,80
Top EASY 300 da 1 colonna	ACC VR	PZ	-	27,00
Top EASY 300 da 2 colonne	ACC VR	PZ	-	40,30
Top EASY 300 da 3 colonne	ACC VR	PZ	-	60,40
Top EASY 300 da 4 colonne	ACC VR	PZ	-	82,70
Top EASY 300 da 5 colonne	ACC VR	PZ	-	91,20
Top EASY 300 da 6 colonne	ACC VR	PZ	-	129,30
Top EASY 300 da 7 colonne	ACC VR	PZ	-	178,10
Top EASY 300 da 8 colonne	ACC VR	PZ	-	195,00



TOP EASY





Laterali EASY



Mantello MODULAR



Mantello CURVE



Cornice

## Rivestimenti EASY

Nome	Materiale	UM	Pez. x conf.	€
Laterali EASY 400 da 1 fila (coppia)	ACC VR	PZ	-	46,60
Laterali EASY 400 da 2 file (coppia)	ACC VR	PZ	-	84,80
Laterali EASY 400 da 3 file (coppia)	ACC VR	PZ	-	116,60
Laterali EASY 400 da 4 file (coppia)	ACC VR	PZ	-	143,10
Laterali EASY 300 da 1 fila (coppia)	ACC VR	PZ	-	53,00
Laterali EASY 300 da 2 file (coppia)	ACC VR	PZ	-	93,30
Laterali EASY 300 da 3 file (coppia)	ACC VR	PZ	-	133,60
Laterali EASY 300 da 4 file (coppia)	ACC VR	PZ	-	165,40
Mantello MODULAR per EasyBox400	ALL AN VR	ML	-	131,40
Mantello MODULAR per EasyBox300	ALL AN VR	ML	-	212,00
Mantello CURVE per EasyBox400	ALL AN VR	ML	-	131,40
Cornice da incasso a muro	ALL AN VR	ML	-	33,70

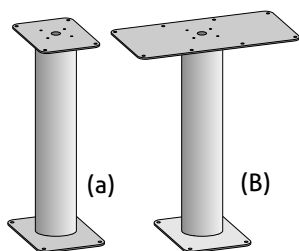

(a)

(b)

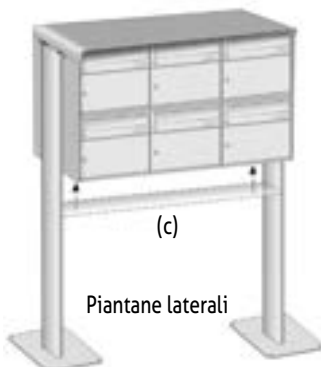

(c)

Piantane laterali

## Piantane e fondale per Serie EasyBox

Nome	Materiale	UM	Pez. x conf.	€
Piantana piccola (a)	ALL VR	PZ	1	187,00
Piantana grande (b)	ALL VR	PZ	1	207,00
Piantane laterali	ALL VR	PZ	coppia	320,00
Supporto per piantane laterali (c) >2 colonne	ALL VR	ML	-	53,00
Prolungamento mantello Modular	ALL VR			preventivo su richiesta
Fondale (solo se su piantana)	ALL VR	MQ	-	150,00

### LEGENDA

ACC = acciaio	ARL = argento liscio Ral 9006	BR = bronzo	GOLD = verniciato ORO	NE = nero Ral 9005	RO = rosso Ral 3003
ALL = alluminio	AV = avorio Ral 1013	CM2 = centimetri quadrati	IX DEC = acciaio inox decorato	OB = ottone brunito	RU = ruggine
AM = argento metallizzato	AZ = azzurro Ral 5015	FE = ferro	IX LI = acciaio inox liscio	OL = ottone lucido	SA = sabbia
AN = anodizzato	BI = bianco Ral 9016	GH = grigio antracite Ral 7016	LZ = lamiera elettrozincata	ORO = colore oro	VE = verde Ral 6005
AR = argento	BRant = bronzo antico	GI = giallo Ral 1003	ML = metro lineare	PF = pressofuso	VR = verniciato



Serratura Kaba



Serratura calamita



Serratura PBlock

## Accessori e Ricambi EasyBox

Nome	Materiale	UM	Pez. x conf.	€
EasyBox 300/400 con sportello posta <b>predisposto</b> per serratura <b>KABA</b>		PZ	1	174,90
{ Serratura per cassetta postale (abbinamento <b>calamita</b> )		PZ	1	9,50
	Pomello + <b>calamita</b> per vano portapacchi	PZ	1	8,50
{ Serratura per cassetta postale (abbinamento serratura <b>PBlock</b> )		PZ	1	11,70
	Serratura <b>PBlock</b>	PZ	1	11,70
Portanome	ALL AN	PZ	1	8,00
FIXBAR - barra fissaggio a muro	LZ	ML	1	35,00



Portanome



Fixbar

## Assemblaggi-Imballi Serie EasyBox

Nome	UM	€
<b>Assemblaggio con rivestimento EASY</b>	a cassetta	12,00
<b>Assemblaggio con rivestimento MODULAR o CURVE</b>	a cassetta	16,00
<b>Assemblaggio con cornice da incasso</b>	a cassetta	9,60
<b>Assemblaggio su piantane laterali</b>		+ 110,00 listino
<b>Imballi EasyBox</b>		a preventivo

## Cassette e Casellari Postali da Interno

**FINO AD  
ESAURIMENTO  
FO  
SCORTE**



JUMBO 5

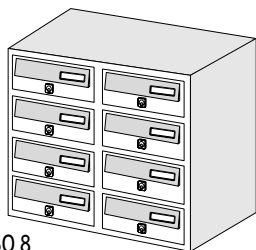

JUMBO 8

### Serie JUMBO

Nome	Materiale	UM	Pez. x conf.	€
JUMBO4**	LZ + ALL AN - AR - VR RO/BI/VE/GH/BR	PZ	1	361,00
JUMBO5**	LZ + ALL AN - AR - VR RO/BI/VE/GH/BR	PZ	1	434,00
JUMBO6*	LZ + ALL AN - AR - VR RO/BI/VE/GH/BR	PZ	1	536,00
JUMBO8*	LZ + ALL AN - AR - VR RO/BI/VE/GH/BR	PZ	1	656,00
PIANTANA con piastra	ALL GH	PZ	1	221,00

\*\* **Versione SP-GOLD: aumentare € 10,00 a sportello**

\* **Versione SP-OTT: aumentare € 34,30 a sportello**

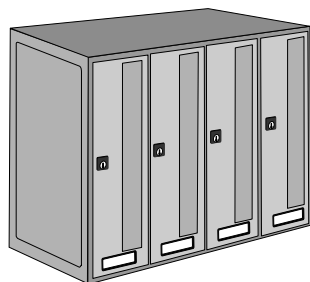

JUMBO 4 FVE

### Serie JUMBO verticale FVE

Nome	Materiale	UM	Pez. x conf.	€
JUMBO4 FVE	LZ + ALL AN - AR/BR - VR RO/BI/VE/GH	PZ	1	265,00
JUMBO5 FVE	LZ + ALL AN - AR/BR - VR RO/BI/VE/GH	PZ	1	335,00
JUMBO6 FVE	LZ + ALL AN - AR/BR - VR RO/BI/VE/GH	PZ	1	410,00

#### Introduzione posta frontale

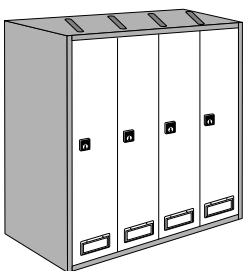

JUMBO 4 VE

### Serie JUMBO verticale VE

Nome	Materiale	UM	Pez. x conf.	€
JUMBO 4 VE	LZ + ALL AN - AR/BR - VR RO/BI/VE/GH	PZ	1	255,00
JUMBO 5 VE	LZ + ALL AN - AR/BR - VR RO/BI/VE/GH	PZ	1	323,00
JUMBO 6 VE	LZ + ALL AN - AR/BR - VR RO/BI/VE/GH	PZ	1	393,00

#### Introduzione posta dall'alto

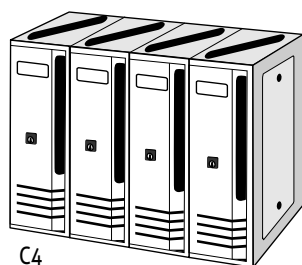

C4

### Serie CUBO Composto

Nome	Materiale	UM	Pez. x conf.	€
C4	ALL VR - GH/RU/SA/AR/BR	PZ	1	136,00
C5	ALL VR - GH/RU/SA/AR/BR	PZ	1	162,00
C6	ALL VR - GH/RU/SA/AR/BR	PZ	1	196,00

#### LEGENDA

ACC = acciaio  
ALL = alluminio  
AM = argento metallizzato  
AN = anodizzato  
AR = argento

ARL = argento liscio Ral 9006  
AV = avorio Ral 1013  
AZ = azzurro Ral 5015  
BI = bianco Ral 9016  
BRant = bronzo antico

BR = bronzo  
CM2 = centimetri quadrati  
FE = ferro  
GH = grigio antracite Ral 7016  
GI = giallo Ral 1003

GOLD = verniciato ORO  
IX DEC = acciaio inox decorato  
IX LI = acciaio inox liscio  
LZ = lamiera elettrozincata  
ML = metro lineare

NE = nero Ral 9005  
OB = ottone brunito  
OL = ottone lucido  
ORO = colore oro  
PF = pressofuso

RO = rosso Ral 3003  
RU = ruggine  
SA = sabbia  
VE = verde Ral 6005  
VR = verniciato

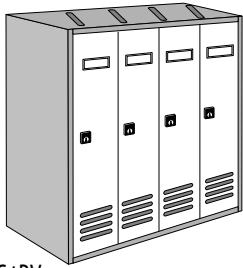

C4RV

## Serie CUBO Composto Rivista Verticale

Nome	Materiale	UM	Pez. x conf.	€
C4RV	LZ VR - BRant/GH/ORO/AM/SA	PZ	1	196,00
C4RVIX	LZ VR - IX LI	PZ	1	230,00
C5RV	LZ VR - BRant/GH/ORO/AM/SA	PZ	1	242,00
C5RVIX	LZ VR - IX LI	PZ	1	276,00
C6RV	LZ VR - BRant/GH/ORO/AM/SA	PZ	1	286,00
C6RVIX	LZ VR - IX LI	PZ	1	330,00

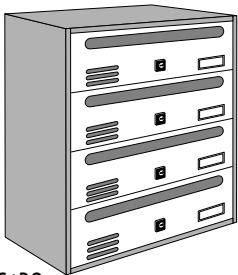

C4RO

## Serie CUBO Composto Rivista Orizzontale

Nome	Materiale	UM	Pez. x conf.	€
C4RO	LZ VR - BRant/GH/ORO/AM/SA	PZ	1	196,00
C4ROIX	LZ VR - IX LI	PZ	1	230,00
C5RO	LZ VR - BRant/GH/ORO/AM/SA	PZ	1	242,00
C5ROIX	LZ VR - IX LI	PZ	1	276,00
C6RO	LZ VR - BRant/GH/ORO/AM/SA	PZ	1	286,00
C6ROIX	LZ VR - IX LI	PZ	1	330,00



C1RV

## Serie CUBO Rivista

Nome	Materiale	UM	Pez. x conf.	€
C1RV	ALL VR - GH - ALL AN - BR	PZ	10	53,50
C1RO	ALL VR - GH - ALL AN - BR	PZ	10	53,50



C1RO

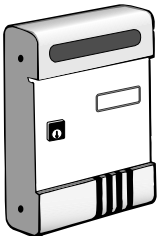

SE

## Serie ESSE

Nome	Materiale	UM	Pez. x conf.	€
SE	ALL VR - AV/GH/SA/RU/AM/AR/BR	PZ	10	48,00
SIRE	ALL VR - AV/GH/SA/RU/AM/AR/BR	PZ	6	64,00

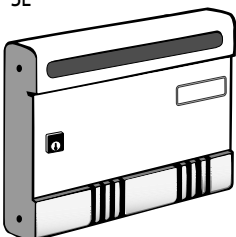

SIRE

### LEGENDA

ACC = acciaio  
ALL = alluminio  
AM = argento metallizzato  
AN = anodizzato  
AR = argento

ARL = argento liscio Ral 9006  
AV = avorio Ral 1013  
AZ = azzurro Ral 5015  
BI = bianco Ral 9016  
BRant = bronzo antico

BR = bronzo  
CM2 = centimetri quadrati  
FE = ferro  
GH = grigio antracite Ral 7016  
GI = giallo Ral 1003

GOLD = verniciato ORO  
IX DEC = acciaio inox decorato  
IX LI = acciaio inox liscio  
LZ = lamiera elettrozincata  
ML = metro lineare

NE = nero Ral 9005  
OB = ottone brunito  
OL = ottone lucido  
ORO = colore oro  
PF = pressofuso

RO = rosso Ral 3003  
RU = ruggine  
SA = sabbia  
VE = verde Ral 6005  
VR = verniciato

## Cassette Postali Singole da Esterno

**FINO AD  
ESAURIMENTO  
SCORTE**

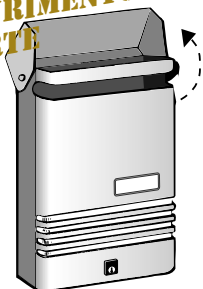

### Serie X

Nome	Materiale	UM	Pez. x conf.	€
XE	ALL AN - BR	PZ	8	41,00
XE/VR	ALL VR - GH	PZ	8	42,00

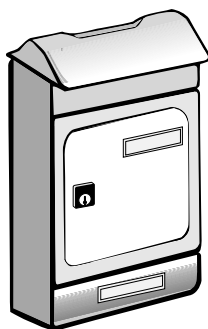

### Serie UNO MAXI

Nome	Materiale	UM	Pez. x conf.	€
UNO MAXI	LZ VR - AV/VE/GH	PZ	6	47,74



### Serie EUROPA RIVISTA

Nome	Materiale	UM	Pez. x conf.	€
EU MAXI	ALL PF - RO/VE/NE/GH/RU/AM/BI	PZ	2	98,40

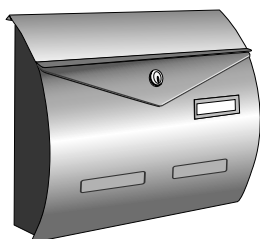

### Serie BUSTA

Nome	Materiale	UM	Pez. x conf.	€
BUSTA	LZ VR - RO/VE/GH/AM/SA	PZ	2	89,00

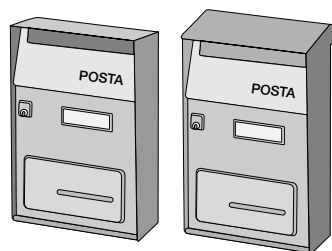

F1

FT

### Serie EFFE

Nome	Materiale	UM	Pez. x conf.	€
F1IX	IX DEC	PZ	8	43,60
FTIX	IX DEC	PZ	8	51,00
FT EVO	IX LI	PZ	8	47,52
FT/VR	LZ VR - BI/VE/GH	PZ	8	36,74

**LEGENDA**  
ACC = acciaio  
ALL = alluminio  
AM = argento metallizzato  
AN = anodizzato  
AR = argento

ARL = argento liscio Ral 9006  
AV = avorio Ral 1013  
AZ = azzurro Ral 5015  
BI = bianco Ral 9016  
BRant = bronzo antico

BR = bronzo  
CM2 = centimetri quadrati  
FE = ferro  
GH = grigio antracite Ral 7016  
GI = giallo Ral 1003

GOLD = verniciato ORO  
IX DEC = acciaio inox decorato  
IX LI = acciaio inox liscio  
LZ = lamiera elettrozincata  
ML = metro lineare

NE = nero Ral 9005  
OB = ottone brunito  
OL = ottone lucido  
ORO = colore oro  
PF = pressofuso

RO = rosso Ral 3003  
RU = ruggine  
SA = sabbia  
VE = verde Ral 6005  
VR = verniciato



## Serie DUBLO

Nome	Materiale	UM	Pez. x conf.	€
DUBLO EVO	IX LI	PZ	6	66,00



## Serie PRIMA

Nome	Materiale	UM	Pez. x conf.	€
PRIMA	LZ VR - NE/AR/VE	PZ	10	20,13
PRIMAMAXI	LZ VR - VE/GH/AR	PZ	6	30,69

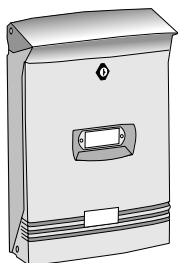

## Serie IBIZA

Nome	Materiale	UM	Pez. x conf.	€
IBIZA	ALL PF VR - GH/BI/VE	PZ	4	79,20

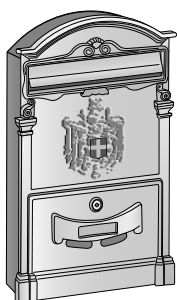

## Serie REGIE POSTE

Nome	Materiale	UM	Pez. x conf.	€
REGIE	ALL VR - GH/VE/BI/BR	PZ	4	36,30



## Serie LETTERE

Nome	Materiale	UM	Pez. x conf.	€
LETTERE	ALL PF VR - RO/VE/GH/RU/SA	PZ	2	95,00



## Serie RESIDENCE

Nome	Materiale	UM	Pez. x conf.	€
RES	ALL PF VR - RO/NE/VE/GH/RU	PZ	2	82,80
RES MAXI	ALL PF VR - RO/NE/VE/GH/RU	PZ	2	107,00

RES

RES MAXI

### LEGENDA

ACC = acciaio  
 ALL = alluminio  
 AM = argento metallizzato  
 AN = anodizzato  
 AR = argento

ARL = argento liscio Ral 9006  
 AV = avorio Ral 1013  
 AZ = azzurro Ral 5015  
 BI = bianco Ral 9016  
 BRant = bronzo antico

BR = bronzo  
 CM2 = centimetri quadrati  
 FE = ferro  
 GH = grigio antracite Ral 7016  
 GI = giallo Ral 1003

GOLD = verniciato ORO  
 IX DEC = acciaio inox decorato  
 IX LI = acciaio inox liscio  
 LZ = lamiera elettrozincata  
 ML = metro lineare

NE = nero Ral 9005  
 OB = ottone brunito  
 OL = ottone lucido  
 ORO = colore oro  
 PF = pressofuso

RO = rosso Ral 3003  
 RU = ruggine  
 SA = sabbia  
 VE = verde Ral 6005  
 VR = verniciato



## Serie Plico Box

Nome	Materiale	UM	Pez. x conf.	€
PLICO BOX	LZ VR - GH	PZ	1	275,00

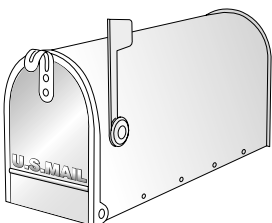

## Serie TOPOLINO

Nome	Materiale	UM	Pez. x conf.	€
USA1	LZ VR - NE/BI/VE/RO/AR	PZ	1	44,11
USAPL	LZ VR - NE	PZ	1	30,36
USA KIT PALO	-	PZ	1	9,90



## Serie QUADRA

Nome	Materiale	UM	Pez. x conf.	€
QUADRAIX	IX LI	PZ	6	76,56
QUADRA	LZ VR - GH/BI	PZ	6	42,68



## Serie CHALET

Nome	Materiale	UM	Pez. x conf.	€
CHALET	LZ VR - GH/BI	PZ	5	50,49

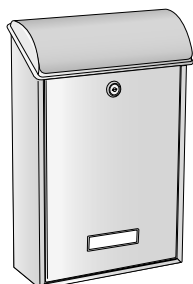

## Serie VILLA

Nome	Materiale	UM	Pez. x conf.	€
VILLAIX	IX LI	PZ	6	74,47
VILLAGH	LZ VR - GH	PZ	6	52,47

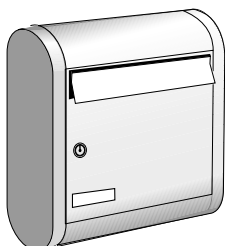

## Serie SOLE

Nome	Materiale	UM	Pez. x conf.	€
SOLE	ALL PF VR - GH/RO	PZ	1	140,00

### LEGENDA

ACC = acciaio	ARL = argento liscio Ral 9006	BR = bronzo	GOLD = verniciato ORO	NE = nero Ral 9005	RO = rosso Ral 3003
ALL = alluminio	AV = avorio Ral 1013	CM2 = centimetri quadrati	IX DEC = acciaio inox decorato	OB = ottone brunito	RU = ruggine
AM = argento metallizzato	AZ = azzurro Ral 5015	FE = ferro	IX LI = acciaio inox liscio	OL = ottone lucido	SA = sabbia
AN = anodizzato	BI = bianco Ral 9016	GH = grigio antracite Ral 7016	LZ = lamiera elettrozincata	ORO = colore oro	VE = verde Ral 6005
AR = argento	BRant = bronzo antico	GI = giallo Ral 1003	ML = metro lineare	PF = pressofuso	VR = verniciato



## Serie PECHINO

Nome	Materiale	UM	Pez. x conf.	€
PECHINO	LZ VR - GH/AR	PZ	5	53,13



SIRIO

## Serie SIRIO

Nome	Materiale	UM	Pez. x conf.	€
SIRIO	LZ VR - GH/AR	PZ	4	50,16
SIRIO LOCK	LZ VR - GH	PZ	4	60,28



SIRIO LOCK



RE

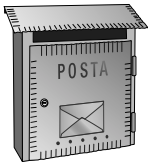

REECO

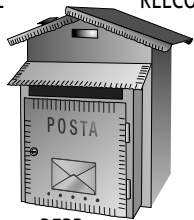

REPP

## Serie RUSTICA

Nome	Materiale	UM	Pez. x conf.	€
<b>RUSTICA</b>				
RE	FE VR - NE	PZ	6	44,00
REECO	FE VR - NE	PZ	12	28,50

### RUSTICA portapane

REPP	FE VR - NE	PZ	2	82,70
------	------------	----	---	-------

**FINO AD  
ESAURIMENTO  
SCORTE**

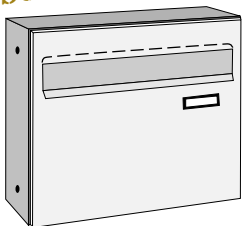

## Serie VENERE

Nome	Materiale	UM	Pez. x conf.	€
VENEREIX	IX DEC	PZ	1	155,00
MPL per Venere	ACC NERO	PZ	coppia	63,60



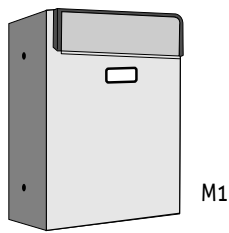

M1

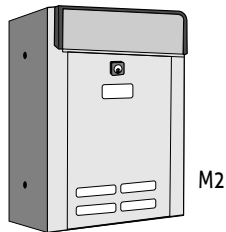

M2

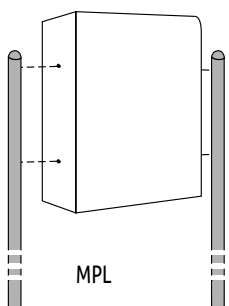

MPL

## Serie MAGNUM

Nome	Materiale	UM	Pez. x conf.	€
M1IX	IX DEC	PZ	1	165,40
M2IX	IX DEC	PZ	1	165,40
M1GH	LZ VR - GH	PZ	1	129,30
M2GH	LZ VR - GH	PZ	1	129,30
MPL per Magnum	ACC NERO	PZ	coppia	63,60



COMBI 1 con rivestimento



COMBI 3 con rivestimento



COMBI 3/2 con cornice

## Cassette postali per CITOFONI

Nome	Materiale	UM	Pez. x conf.	€
COMBI 1 con rivestimento *	ALL AN AR VR -GH/RO/VE/BI	PZ	1	244,86
COMBI 1 con cornice *	ALL AN AR VR -GH/RO/VE/BI	PZ	1	211,47
COMBI 3 con rivestimento **			a preventivo	
COMBI 3 con cornice **			a preventivo	
COMBI 3/2 con rivestimento **			a preventivo	
COMBI 3/2 con cornice**			a preventivo	

\*\* **Accessori** (non forniti) vedi catalogo nell'apposita sezione

\* **BTicino Sfera New**

solo predisposizione

**TEMPI DI CONSEGNA: 30 giorni data ordine**

### LEGENDA

ACC = acciaio	ARL = argento liscio Ral 9006	BR = bronzo	GOLD = verniciato ORO	NE = nero Ral 9005	RO = rosso Ral 3003
ALL = alluminio	AV = avorio Ral 1013	CM2 = centimetri quadrati	IX DEC = acciaio inox decorato	OB = ottone brunito	RU = ruggine
AM = argento metallizzato	AZ = azzurro Ral 5015	FE = ferro	IX LI = acciaio inox liscio	OL = ottone lucido	SA = sabbia
AN = anodizzato	BI = bianco Ral 9016	GH = grigio antracite Ral 7016	LZ = lamiera elettrozincata	ORO = colore oro	VE = verde Ral 6005
AR = argento	BRant = bronzo antico	GI = giallo Ral 1003	ML = metro lineare	PF = pressofuso	VR = verniciato

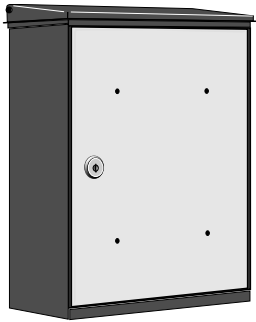

Corpo Cassetta MIA con sportello

## Cassetta postale PERSONALIZZABILE con COVER INTERCAMBIABILE

Nome	Materiale	UM	Pez. x conf.	€
Corpo CASSETTA MIA + sportello	LZ VR - GH e GI/AZ	PZ	4	45,90
MIA COVERS	LZ VR	PZ	2	25,50
KIT Palo per cassetta MIA	LZ - VR NE	PZ	1	32,00
KIT Traversini per cassetta MIA	LZ - VR GH	PZ	coppia	17,50

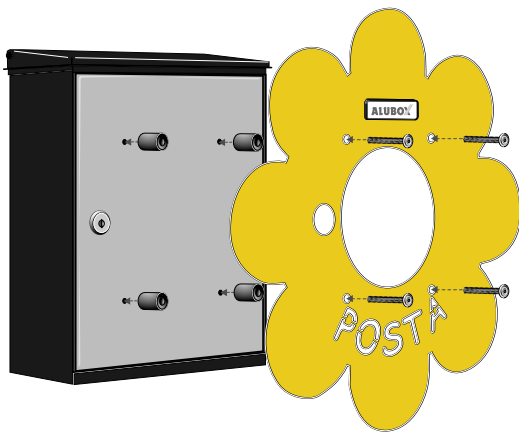

Palo

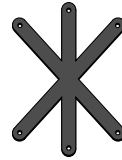

Traversini

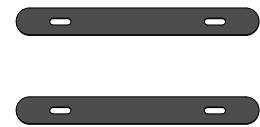

COVER

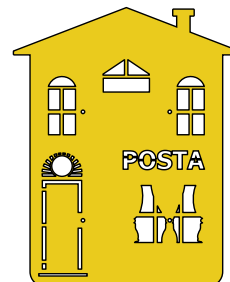
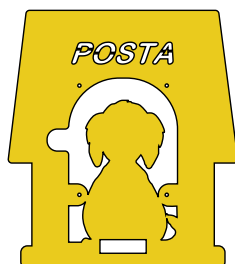
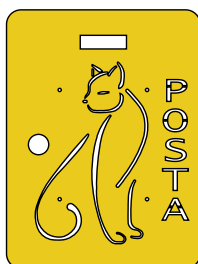
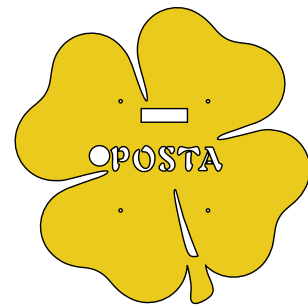
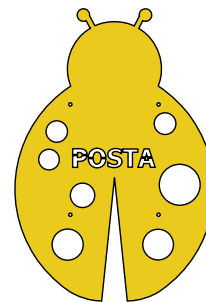
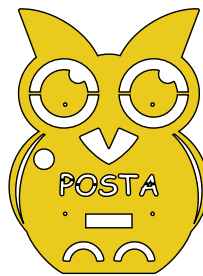
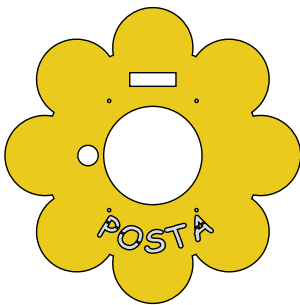

### LEGENDA

ACC = acciaio  
ALL = alluminio  
AM = argento metallizzato  
AN = anodizzato  
AR = argento

ARL = argento liscio Ral 9006  
AV = avorio Ral 1013  
AZ = azzurro Ral 5015  
BI = bianco Ral 9016  
BRant = bronzo antico

BR = bronzo  
CM2 = centimetri quadrati  
FE = ferro  
GH = grigio antracite Ral 7016  
GI = giallo Ral 1003

GOLD = verniciato ORO  
IX DEC = acciaio inox decorato  
IX LI = acciaio inox liscio  
LZ = lamiera elettrozincata  
ML = metro lineare

NE = nero Ral 9005  
OB = ottone brunito  
OL = ottone lucido  
ORO = colore oro  
PF = pressofuso

RO = rosso Ral 3003  
RU = ruggine  
SA = sabbia  
VE = verde Ral 6005  
VR = verniciato



## Cassette PORTAPACCHI



PaccoBoxXL

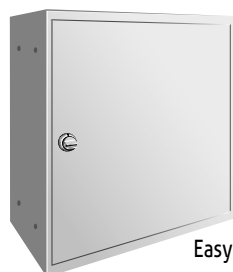

EasyBox VANO UNICO

### Portapacchi PACCOBOX XL e EasyBox Vano Unico

Nome	Materiale	UM	Pez. x conf.	€
<b>PaccoBoxXL</b>	LZ VR - GH	PZ	1	244,00
Piantana per portapacchi - H 90	ALL VR - GH	PZ	1	187,00
Piastra fissaggio	ACC VR - GH	PZ	1	39,90
Traversini per fissaggio cancellata TR400	ALL	PZ	coppia	13,30

<b>EasyBox VANO UNICO</b> (serratura PBlock)	LZ - VR GH/ARL	PZ	1	137,80
Traversini per fissaggio a cancellata TR300	ALL	PZ	coppia	12,30
Piantana piccola - H 90	ALL VR - GH	PZ	1	172,80



Modular LP



EasyBox

### Cassette Postali con Vano PORTA PACCHI

Nome	Materiale	UM	Pez. x conf.	€
<b>Modular LP</b>	LZ VR - GH/AM	PZ	1	413,00
Piantana per portapacchi - H 90	ALL VR - GH/AM	PZ	1	187,00
Piastra fissaggio	ACC VR - GH/AM	PZ	1	39,90
Traversini per fissaggio cancellata TR400	ALL	PZ	coppia	13,30

<b>EasyBox</b> (vano pacchi con serratura PBlock)	LZ - VR GH/ARL	PZ	1	195,00
Traversini per fissaggio a cancellata TR300	ALL	PZ	coppia	12,30
Piantana piccola - H 90	ALL VR - GH	PZ	1	172,80

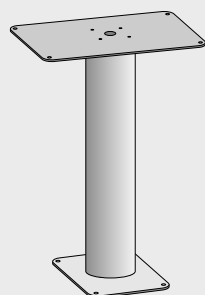

Piantana per PaccoBoxXL e Modular LP

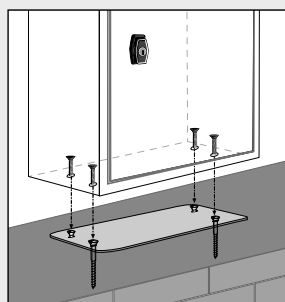

Piastra per PaccoBoxXL e Modular LP

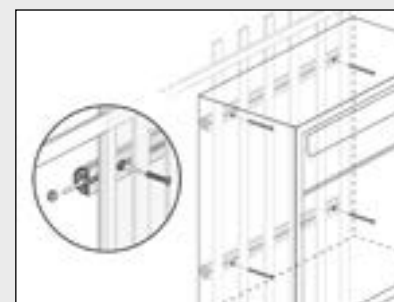

Traversini per PaccoBoxXL, EasyBox Vano Unico, ModularLP e EasyBox

### LEGENDA

ACC = acciaio	ARL = argento liscio Ral 9006	BR = bronzo	GOLD = verniciato ORO	NE = nero Ral 9005	RO = rosso Ral 3003
ALL = alluminio	AV = avorio Ral 1013	CM2 = centimetri quadrati	IX DEC = acciaio inox decorato	OB = ottone brunito	RU = ruggine
AM = argento metallizzato	AZ = azzurro Ral 5015	FE = ferro	IX LI = acciaio inox liscio	OL = ottone lucido	SA = sabbia
AN = anodizzato	BI = bianco Ral 9016	GH = grigio antracite Ral 7016	LZ = lamiera elettrozincata	ORO = colore oro	VE = verde Ral 6005
AR = argento	BRant = bronzo antico	GI = giallo Ral 1003	ML = metro lineare	PF = pressofuso	VR = verniciato

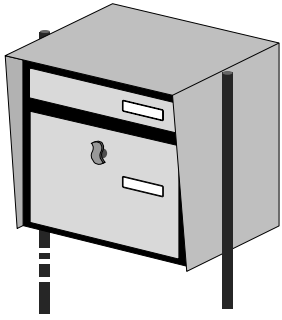

## Serie PORTAPANE

Nome	Materiale	UM	Pez. x conf.	€
PPP 2 prelievo posteriore	ALL VR - GH	PZ	1	323,30
PPP 1 prelievo frontale	ALL VR - GH	PZ	1	314,00
MPL (pali)	ACC NERO	PZ	coppia	63,60

## Raccogliposta -Sportelli - Frontali - Copriferitoia

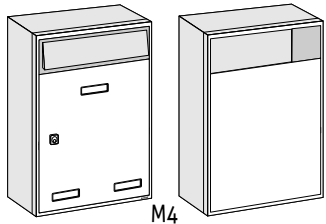

M4

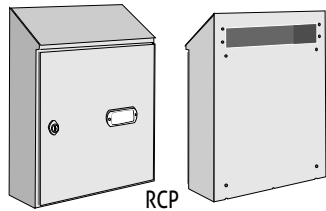

RCP

## Serie RACCOGLIPOSTA

Nome	Materiale	UM	Pez. x conf.	€
M4	ALL AN TM - sportello GH	PZ	6	88,50
RCP	LZ VR - GH	PZ	4	84,59

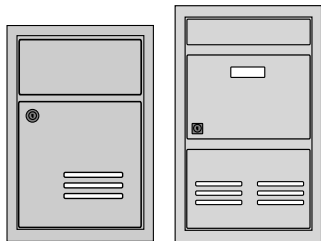

SC1



SC2

## SPORTELLI da incasso

Nome	Materiale	UM	Pez. x conf.	€
SC1	ALL VR GH/AM*/AR	PZ	4	55,70
SC2	ALL AN - BR* - VR GH/AM*/AR	PZ	4	56,70

\* Finitura ad esaurimento

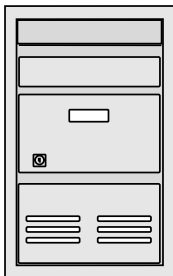

SC4

## FRONTALI da incasso con elemento mobile

Nome	Materiale	UM	Pez. x conf.	€
SC4	ALL AN - AR* - VR GH/AR	PZ	2	70,00

\* Finitura ad esaurimento

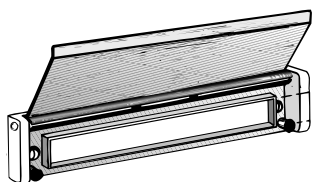

## COPRIFERITOIA

Nome	Materiale	UM	Pez. x conf.	€
CFR	ALL AN - AR* VR - NE/AM*	PZ	6	20,80

\* Finitura ad esaurimento

## Raccoglitori Pubblicità

### Serie RACCOGLITORI Pubblicità



Nome	Materiale	UM	Pez. x conf.	€
<b>CAROSELLO PUBBLICITÀ</b>				
CAROSELLO	POLICARBONATO - GH	PZ	4	28,10

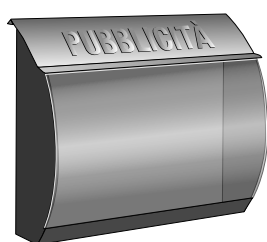

### BUSTA PUBBLICITÀ

BUSTA	LZ GH	PZ	2	60,00
-------	-------	----	---	-------

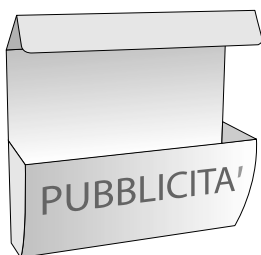

### RECLAME PUBBLICITÀ

RECLAME	LZ ARS - GH	PZ	2	36,30
---------	-------------	----	---	-------

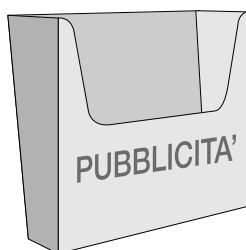

### HELLAS PUBBLICITÀ

HELLAS	LZ VR - BI/GH	PZ	2	31,13
--------	---------------	----	---	-------

### PUBBLICITÀ



### KIT PUBBLICITÀ

Targa pubblicità + Serratura a cricchetto		PZ	1	19,80
---	--	----	---	-------

#### LEGENDA

ACC = acciaio  
 ALL = alluminio  
 AM = argento metallizzato  
 AN = anodizzato  
 AR = argento

ARL = argento liscio Ral 9006  
 AV = avorio Ral 1013  
 AZ = azzurro Ral 5015  
 BI = bianco Ral 9016  
 BRant = bronzo antico

BR = bronzo  
 CM2 = centimetri quadrati  
 FE = ferro  
 GH = grigio antracite Ral 7016  
 GI = giallo Ral 1003

GOLD = verniciato ORO  
 IX DEC = acciaio inox decorato  
 IX LI = acciaio inox liscio  
 LZ = lamiera elettrozincata  
 ML = metro lineare

NE = nero Ral 9005  
 OB = ottone brunito  
 OL = ottone lucido  
 ORO = colore oro  
 PF = pressofuso

RO = rosso Ral 3003  
 RU = ruggine  
 SA = sabbia  
 VE = verde Ral 6005  
 VR = verniciato



Serie  
OTTONE

## Serie OTTONE

**FINO AD  
ESAURIMENTO  
SCORTE**

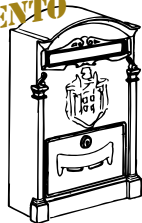

### Serie RESIDENCE OTTONE

Nome	Materiale	UM	Pez. x conf.	€
RES	OTTONE GH	PZ	1	254,00

### Serie ANTICA OTTONE

Nome	Materiale	UM	Pez. x conf.	€
A3	OTTONE OL/OB	PZ	1	125,10
A3	OTTONE VR - GH	PZ	1	133,60
A4	OTTONE OL	PZ	1	180,00
A5	OTTONE OL/OB	PZ	1	220,50
A5	OTTONE VR - GH	PZ	1	239,60
A6	OTTONE OL/OB	PZ	1	97,50
A6	OTTONE VR - GH	PZ	1	104,90

**FINO AD  
ESAURIMENTO  
SCORTE**

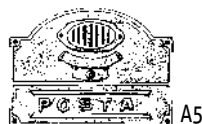

**FINO AD  
ESAURIMENTO  
SCORTE**

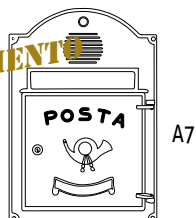

**FINO AD  
ESAURIMENTO  
SCORTE**



A7	OTTONE VR - GH	PZ	1	460,00
----	----------------	----	---	--------

A8	OTTONE OL/OB	PZ	1	138,00
----	--------------	----	---	--------

### SPORTELLLO OTTONE

Nome	Materiale	UM	Pez. x conf.	€
SC3	OTTONE OL/OB	PZ	1	207,80
SC3	OTTONE - VR GH	PZ	1	233,20

### COPRIFERITOIA OTTONE

Nome	Materiale	UM	Pez. x conf.	€
CFR	OTTONE OL/OB/GH	PZ	6	48,80

#### LEGENDA

ACC = acciaio	ARL = argento liscio Ral 9006	BR = bronzo	GOLD = verniciato ORO	NE = nero Ral 9005	RO = rosso Ral 3003
ALL = alluminio	AV = avorio Ral 1013	CM2 = centimetri quadrati	IX DEC = acciaio inox decorato	OB = ottone brunito	RU = ruggine
AM = argento metallizzato	AZ = azzurro Ral 5015	FE = ferro	IX LI = acciaio inox liscio	OL = ottone lucido	SA = sabbia
AN = anodizzato	BI = bianco Ral 9016	GH = grigio antracite Ral 7016	LZ = lamiera elettrozincata	ORO = colore oro	VE = verde Ral 6005
AR = argento	BRant = bronzo antico	GI = giallo Ral 1003	ML = metro lineare	PF = pressofuso	VR = verniciato

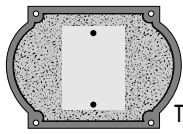

TARGA 1

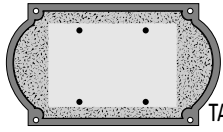

TARGA 2

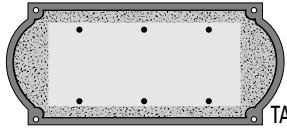

TARGA 3

## TARGHE porta Numeri e Numeri Civici

Nome	Materiale	UM	Pez. x conf.	€
TARGA 1	OTTONE OL/OB/GH	PZ	1	37,50
TARGA 2	OTTONE OL/OB/GH	PZ	1	44,80
TARGA 3	OTTONE OL/OB/GH	PZ	1	60,00



CIV

## Numeri Civici

Numeri Civici dallo 0 al 9 (CIV)	OTTONE OL/OB/GH	PZ	1	21,80
Lettere dalla A alla D	OTTONE OL/OB/GH	PZ	1	21,80

## FINO AD ESAURIMENTO SCORTE

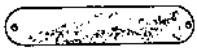

B275

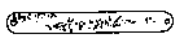

B230

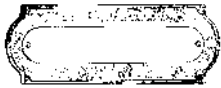

TP1

## TARGHE PORTA NOME

B275/55	OTTONE OL	PZ	1	39,10
TP1	OTTONE OL/OB	PZ	1	100,00
TP2	OTTONE OL/OB	PZ	1	117,00

## CAMPANELLI

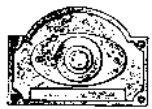

CL

Nome	Materiale	UM	Pez. x conf.	€
CL	OTTONE OL/OB	PZ	1	65,50
CL	OTTONE VR - GH	PZ	1	74,20

## FINO AD ESAURIMENTO SCORTE



CL LEOP



CL LEO

CL LEOP	OTTONE OL	PZ	1	44,80
CL LEO	OTTONE OL/OB	PZ	1	48,50

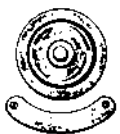

CLV

CLV	OTTONE OL	PZ	1	66,80
-----	-----------	----	---	-------

## LEGENDA

ACC = acciaio  
ALL = alluminio  
AM = argento metallizzato  
AN = anodizzato  
AR = argento

ARL = argento liscio Ral 9006  
AV = avorio Ral 1013  
AZ = azzurro Ral 5015  
BI = bianco Ral 9016  
BRant = bronzo antico

BR = bronzo  
CM2 = centimetri quadrati  
FE = ferro  
GH = grigio antracite Ral 7016  
GI = giallo Ral 1003

GOLD = verniciato ORO  
IX DEC = acciaio inox decorato  
IX LI = acciaio inox liscio  
LZ = lamiera elettrozincata  
ML = metro lineare

NE = nero Ral 9005  
OB = ottone brunito  
OL = ottone lucido  
ORO = colore oro  
PF = pressofuso

RO = rosso Ral 3003  
RU = ruggine  
SA = sabbia  
VE = verde Ral 6005  
VR = verniciato



**FINO AD  
ESAURIMENTO  
SCORTE**



PLS6



PLS8

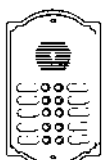

PLS10

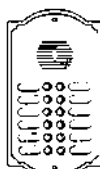

PLS12

## PULSANTIERE

Nome	Materiale	UM	Pez. x conf.	€
PLS6	OTTONE OB	PZ	1	432,00
PLS8	OTTONE VR - GH	PZ	1	650,00
PLS10	OTTONE OB	PZ	1	588,00
PLS10	OTTONE VR - GH	PZ	1	614,00
PLS12	OTTONE OB	PZ	1	645,00
PLS12	OTTONE VR - GH	PZ	1	675,00



PLS 1 TC

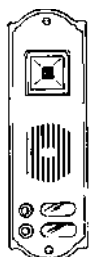

PLS 2 TC

PLS1TC	OTTONE OL	PZ	1	336,00
PLS2TC	OTTONE OL/OB	PZ	1	360,00

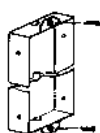

KIT/PLS  
3/6

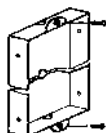

KIT/PLS  
8/10/12

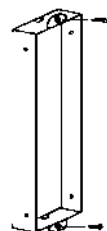

KIT PLTC

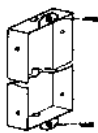

KIT PLS  
1/2 TC

## Kit per Pulsantiera e Campanelli in Ottone

Nome	Materiale	UM	Pez. x conf.	€
KIT/PLS 3 e 6 - 8/10/12	LZ	PZ	1	22,30
KIT/PLTC	LZ	PZ	1	22,30
KIT PLS 1/2 TC	LZ	PZ	1	22,30

### LEGENDA

ACC = acciaio  
ALL = alluminio  
AM = argento metallizzato  
AN = anodizzato  
AR = argento

ARL = argento liscio Ral 9006  
AV = avorio Ral 1013  
AZ = azzurro Ral 5015  
BI = bianco Ral 9016  
BRant = bronzo antico

BR = bronzo  
CM2 = centimetri quadrati  
FE = ferro  
GH = grigio antracite Ral 7016  
GI = giallo Ral 1003

GOLD = verniciato ORO  
IX DEC = acciaio inox decorato  
IX LI = acciaio inox liscio  
LZ = lamiera elettrozincata  
ML = metro lineare

NE = nero Ral 9005  
OB = ottone brunito  
OL = ottone lucido  
ORO = colore oro  
PF = pressofuso

RO = rosso Ral 3003  
RU = ruggine  
SA = sabbia  
VE = verde Ral 6005  
VR = verniciato

## BACHECHE



SIMPLEX1AR

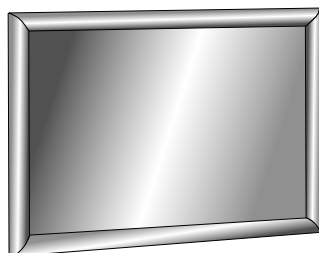

SIMPLEX2AR

## BACHECHE PORTA AVVISI

Nome	Materiale	UM	Pez. x conf.	€
SIMPLEX1AR (A4)	ALL AN AR	PZ	5	37,40
SIMPLEX2AR (2 A4 o 1 A3)	ALL AN AR	PZ	5	49,50

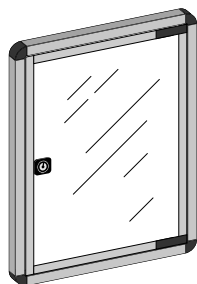

BC/1

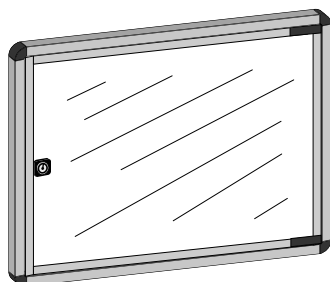

BC/2

BC/1 (A4)	VR GH/AM ● ALL AN BR	PZ	2	85,00
BC/2 (2 A4 o 1 A3)	VR GH/AM ● ALL AN BR	PZ	2	112,00
BC/5 (4 A4 o 2 A3)	VR GH/AM ● ALL AN BR	PZ	1	178,00
Magneti per bacheche porta avvisi		PZ	1	3,50

● Verniciato **SABBIA** e **RUGGINE** solo su ordinazione allo stesso prezzo

## SPORTELLI\*

Sportello per BC/1	ALL	PZ	1	38,20
Sportello per BC/2	ALL	PZ	1	53,00
Sportello per BC/5	ALL	PZ	1	77,40

\* Specificare se **Bronzo, Grigio Antracite, Argento Metallizzato, Sabbia o Ruggine**

## LEGENDA

ACC = acciaio  
ALL = alluminio  
AM = argento metallizzato  
AN = anodizzato  
AR = argento

ARL = argento liscio Ral 9006  
AV = avorio Ral 1013  
AZ = azzurro Ral 5015  
BI = bianco Ral 9016  
BRant = bronzo antico

BR = bronzo  
CM2 = centimetri quadrati  
FE = ferro  
GH = grigio antracite Ral 7016  
GI = giallo Ral 1003

GOLD = verniciato ORO  
IX DEC = acciaio inox decorato  
IX LI = acciaio inox liscio  
LZ = lamiera elettrozincata  
ML = metro lineare

NE = nero Ral 9005  
OB = ottone brunito  
OL = ottone lucido  
ORO = colore oro  
PF = pressofuso

RO = rosso Ral 3003  
RU = ruggine  
SA = sabbia  
VE = verde Ral 6005  
VR = verniciato

## BACHECHE PORTA CHIAVI

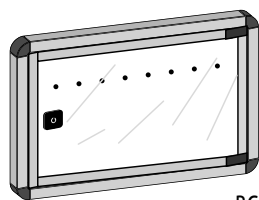

BC/8

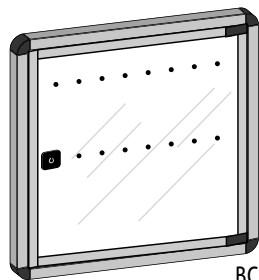

BC/16

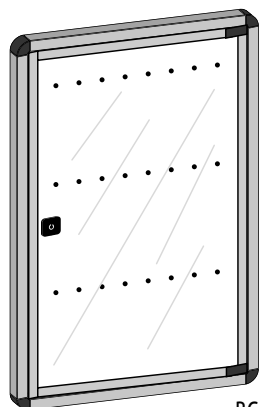

BC/24

Nome	Materiale	UM	Pez. x conf.	€
BC/8 (8 chiavi)	VR GH/AM ● ALL AN BR	PZ	6	56,00
BC/16 (16 chiavi)	VR GH/AM ● ALL AN BR	PZ	4	92,00
BC/24 (24 chiavi)	VR GH/AM ● ALL AN BR	PZ	2	112,00
BC/48 (48 chiavi)	VR GH/AM ● ALL AN BR	PZ	2	142,00
BC/96 (96 chiavi)	VR GH/AM ● ALL AN BR	PZ	1	204,00

● Verniciato **SABBIA** e **RUGGINE** solo su ordinazione allo stesso prezzo

### SPORTELLI\*

Sportello per BC/8	ALL	PZ	1	23,30
Sportello per BC/16	ALL	PZ	1	30,70
Sportello per BC/24	ALL	PZ	1	38,20
Sportello per BC/48	ALL	PZ	1	53,00
Sportello per BC/96	ALL	PZ	1	77,40

\* Specificare se **Bronzo**, **Grigio Antracite**, **Argento Metallizzato**, **Sabbia** o **Ruggine**

## PORTA CHIAVI Mia

Nome	Materiale	UM	Pez. x conf.	€
PORTA CHIAVI MIA intaglio LASER	LZ - VR BI e GH	PZ	2	61,50
PORTA CHIAVI MIA SERIGRAFIA	LZ - VR BI	PZ	2	61,50

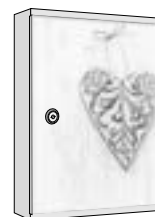
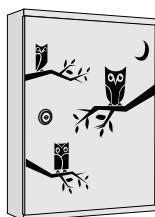
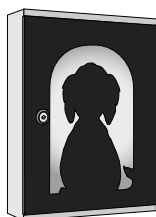

PORTA CHIAVI MIA intaglio LASER

PORTA CHIAVI MIA SERIGRAFIA

### LEGENDA

ACC = acciaio  
ALL = alluminio  
AM = argento metallizzato  
AN = anodizzato  
AR = argento

ARL = argento liscio Ral 9006  
AV = avorio Ral 1013  
AZ = azzurro Ral 5015  
BI = bianco Ral 9016  
BRant = bronzo antico

BR = bronzo  
CM2 = centimetri quadrati  
FE = ferro  
GH = grigio antracite Ral 7016  
GI = giallo Ral 1003

GOLD = verniciato ORO  
IX DEC = acciaio inox decorato  
IX LI = acciaio inox liscio  
LZ = lamiera elettrozincata  
ML = metro lineare

NE = nero Ral 9005  
OB = ottone brunito  
OL = ottone lucido  
ORO = colore oro  
PF = pressofuso

RO = rosso Ral 3003  
RU = ruggine  
SA = sabbia  
VE = verde Ral 6005  
VR = verniciato

## Le cose di ALUBOX



## NUMERI RESINATI ADESIVI

Nome	Materiale	UM	Pez. x conf.	€
NUMERI 0 - 9 / lettere A-B-C-D-E	RESINA	PZ	5	3,20
ESPOSITORE serie completa 80 pezzi		PZ	80	240,00

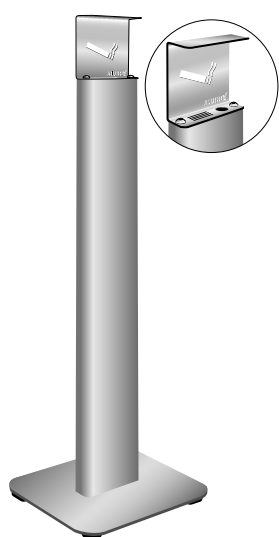
32<sup>A</sup>

## POSACENERE

Nome	Materiale	UM	Pez. x conf.	€
Posacenero da TERRA ITALIA	ALL+LZ VR - GH/AR	PZ	1	142,00
Posacenero da MURO	ALL	PZ	1	101,20

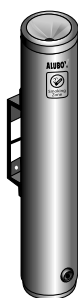
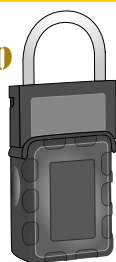
FINO AD  
ESAURIMENTO  
SCORTELUCCHETTO porta oggetti portatile **lucchetto**

Nome	Materiale	UM	Pez. x conf.	€
LUCCHETTO porta oggetti portatile	Lega di Zinco	PZ	6	14,90

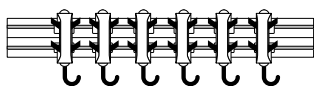
FINO AD  
ESAURIMENTO  
SCORTE

## APPENDITUTTO UNIVERSALE TENG0

**Tengo**

Nome	Materiale	UM	Pez. x conf.	€
TENGO	ALL	PZ	20	17,50

FINO AD  
ESAURIMENTO  
SCORTE

zampirINO



zampirELLA

## Porta Spirale e Citronella anti-ZANZARE

Nome	Materiale	UM	Pez. x conf.	€
zampirINO	LZ - VR	PZ	10	4,20
zampirELLA	LZ - VR	PZ	10	5,40

## LEGENDA

ACC = acciaio  
ALL = alluminio  
AM = argento metallizzato  
AN = anodizzato  
AR = argento

ARL = argento liscio Ral 9006  
AV = avorio Ral 1013  
AZ = azzurro Ral 5015  
BI = bianco Ral 9016  
BRant = bronzo antico

BR = bronzo  
CM2 = centimetri quadrati  
FE = ferro  
GH = grigio antracite Ral 7016  
GI = giallo Ral 1003

GOLD = verniciato ORO  
IX DEC = acciaio inox decorato  
IX LI = acciaio inox liscio  
LZ = lamiera elettrozincata  
ML = metro lineare

NE = nero Ral 9005  
OB = ottone brunito  
OL = ottone lucido  
ORO = colore oro  
PF = pressofuso

RO = rosso Ral 3003  
RU = ruggine  
SA = sabbia  
VE = verde Ral 6005  
VR = verniciato

## RICAMBI

Articolo	Descrizione	€
-	Serratura a cilindro con 2 chiavi (SPECIFICARE IL MODELLO DELLA CASSETTA)	11,40
-	Serratura a cricchetto senza chiave (SPECIFICARE IL MODELLO DELLA CASSETTA)	12,20
-	Chiavi grezze (SPECIFICARE IL MODELLO DELLA CASSETTA)	2,20
CCO (PTUNI)	Portanome adesivo ottone universale per Serie EUROPA MAXI - RESIDENCE - RESIDENCE MAXI	6,40
-	Portanome in plastica (SPECIFICARE IL MODELLO DELLA CASSETTA)	3,80
-	Portanome per Placche bucalettere Ottone (SPECIFICARE IL MODELLO)	19,10
CCHPNP	Portanome in plastica per Chalet e Quadra/colore	4,80
CASPRCP	Portanome cromato per RCP	5,60
CAE7	Portanome Modular Verticale	4,60
31PPLS	Portanome per pulsantiere e campanelli in ottone	4,30
CAD1	Plexiglas per feritoie Serie XE	5,40
CAD2	Plexiglas per feritoie Serie XER	7,60
-	Plexiglas per feritoie Serie Esse - Si.r/e - Citofono - Dublo SC1 - SC2 - Effe - Magnum - Uno Maxi (SPECIFICARE IL MODELLO)	3,80
CEUMACP	Plexiglas Serie residence - RESIDENCE MAXI - europa (specificare serie)	1,90
20SPCUBO	Sportello per Serie cubo COMPOSTO completo di serratura (specificare colore)	22,30
20SPCUBORIV	Sportello per Serie CUBO RIVISTA (specificare colore, orizzontale o verticale)	24,40
20SPCCRS	Sportello CUBO COMPOSTO RIVISTA (specificare colore, orizzontale o verticale)	23,40
20SPCCRIX	Sportello CUBO COMPOSTO RIVISTA INOX (specificare orizzontale o verticale)	41,20
02SPESSE	Sportello per SI - SE (specificare colore)	19,50
04SPSIRE	Sportello per SIR - SIRE (specificare colore)	22,50
31APL	Pulsante ottone per Serie A4 -A5 - A7 - CL - PULSANTIERE	13,70
CMATPUB	Targa adesiva con serigrafia PUBBLICITÀ	7,60

### LEGENDA

ACC = acciaio  
ALL = alluminio  
AM = argento metallizzato  
AN = anodizzato  
AR = argento

ARL = argento liscio Ral 9006  
AV = avorio Ral 1013  
AZ = azzurro Ral 5015  
BI = bianco Ral 9016  
BRant = bronzo antico

BR = bronzo  
CM2 = centimetri quadrati  
FE = ferro  
GH = grigio antracite Ral 7016  
GI = giallo Ral 1003

GOLD = verniciato ORO  
IX DEC = acciaio inox decorato  
IX LI = acciaio inox liscio  
LZ = lamiera elettrozincata  
ML = metro lineare

NE = nero Ral 9005  
OB = ottone brunito  
OL = ottone lucido  
ORO = colore oro  
PF = pressofuso

RO = rosso Ral 3003  
RU = ruggine  
SA = sabbia  
VE = verde Ral 6005  
VR = verniciato

## ACCESSORI

Articolo	Descrizione	€
TR160*	Traversini in alluminio per fissaggio a recinzione per Serie: Lettere, Rustica, XE, XER, Uno Maxi, Effe, Dublo, Prima, Prima Maxi, Regie Poste, Quadra, Ibiza, Residence, Residence Maxi, Europa	10,20
TR220*	Traversini per cassetta MIA in lamiera zincata verniciata grigio ghisa	17,50
TR260*	Traversini in alluminio per fissaggio a recinzione per Serie: M2, Modular 3, Sirio, Villa, Chalet, Pechino	11,20
TR300*	Traversini in alluminio per fissaggio a recinzione per Serie: Marte, Giove, Saturno, Busta, Sole, Modular LP, EasyBox, Portapane, Reclame e Marsupio	12,30
TR400*	Traversini per PaccoBox XL	13,30
*	Completi di viti e dadi. (confezione da 18 coppie)	
TRBAR3000	Barra da 3 metri traversino in alluminio	46,10

## Condizioni Generali di Vendita

- IVA esclusa
- **Resa:** porto franco con addebito in fattura
- **Imballo di serie:** gratis (escluso serie MODULAR e Serie CURVE a preventivo)
- **Le quantità** dovranno essere uguali o multiple del minimo imballo
- **Eventuali disimballi** € 2,00 netto.
- **Importo minimo dell'ordine** € 200,00 netto.
- **Verniciatura casellari Modular, Curve e Easybox:** colori RAL non standard a preventivo previa disponibilità.
- **Spese gestione per mancato raggiungimento** minimo d'ordine € 5,00 netto.

## LEGENDA

ACC = acciaio	ARL = argento liscio Ral 9006	BR = bronzo	GOLD = verniciato ORO	NE = nero Ral 9005	RO = rosso Ral 3003
ALL = alluminio	AV = avorio Ral 1013	CM2 = centimetri quadrati	IX DEC = acciaio inox decorato	OB = ottone brunito	RU = ruggine
AM = argento metallizzato	AZ = azzurro Ral 5015	FE = ferro	IX LI = acciaio inox liscio	OL = ottone lucido	SA = sabbia
AN = anodizzato	BI = bianco Ral 9016	GH = grigio antracite Ral 7016	LZ = lamiera elettrozincata	ORO = colore oro	VE = verde Ral 6005
AR = argento	BRant = bronzo antico	GI = giallo Ral 1003	ML = metro lineare	PF = pressofuso	VR = verniciato

## Agenti Italia Settore Ferramenta

### Piemonte - Valle d'Aosta

Francesco Iampietro

Cellulare 335-6770141

Tel/Fax uff. 011 0133003

e-mail: iampietrofrancesco@gmail.com

### Lombardia

Pasini Rappresentanze

Tel. 02-48952193 - Fax 02-4222033

Giancarlo Pasini: Cellulare 335-5456858

Claudio Pasini: Cellulare 335-5718302

e-mail: pasini@parenz.it

### Veneto - Trentino

R.A.F. DI LONGO MARIO

Mario Longo: 329-4443290

e-mail: mariolng4@gmail.com

### Friuli V.G.

Gianluca Podrecca

Cellulare 335-8140638

e-mail: gianluca.podrecca@gmail.com

### Liguria

Lorenzo Romiti

Tel. 010-5959383 - Fax 010-5951650

Cellulare 348-4124231

e-mail: info@rpritalia.it

### Emilia Romagna - Marche - Toscana - Umbria

Ghedini Giorgio & C. s.n.c.

Tel. 051-6236052 - Fax 051-6235722

Cellulare 339-4048358

e-mail: ghedini.giorgio@libero.it

### Abruzzo - Molise

Mario Ballistreri

Fax 071-714122 - Cellulare 349-2550232

e-mail: mario.b46@libero.it

e-mail: ballistrerirappresentanze@gmail.com

### Lazio

Pompei Rappresentanze s.a.s.

Tel. 06-2148202 - Fax 06-2148205

Herbert Pompei: Cellulare 393-5767219

Alessandro Pompei: Cellulare 335-5767217

e-mail: pompeirap@pompeirap.it

### Campania

Cibelli Rappresentanze s.a.s.

Tel. 081-270910 - Fax 081-271663

e-mail: info@cibellirappresentanze.it

Enzo De Rosa: Cellulare 338-1527564

e-mail: enzojuniorderosa@gmail.com

Enrico Scognamiglio: Cellulare 335-8415042

e-mail: scognamiglioenrico5@gmail.com

### Calabria

LMGROUP s.a.s.

Tel./Fax 0984-433487

e-mail: info@groupm.it

Stefano Minardi: Cellulare 346-7058753

e-mail: s.minardi@groupm.it

Carminio Minardi: Cellulare 348-5201646

e-mail: c.minardi@groupm.it

Fortunato Lucia: Cellulare 348-5201645

e-mail: f.lucia@groupm.it

### Puglia - Basilicata

2R RAPPRESENTANZE

080-4793283

Raffaele Visicchio - Raffaele Chieco

e-mail: info@2rappresentanze.it

### Sicilia Orientale

Umberto D'Urso

Siracusa - Ragusa - Enna - Catania

Tel. 095-7640233 - Cellulare 337-634632

Sandro Scandura

Messina e Catania

Cellulare 335-6225369

e-mail: scanduradurso@gmail.com

### Sicilia Occidentale

La Bianca Rappresentanze

Palermo - Trapani - Agrigento - Caltanissetta

Tel. 091-8613315 - Fax 091-8670875

Andrea La Bianca: Cellulare 338-4214621

e-mail: labirap@gmail.com

### Sardegna

Alessandro Mainas

Cellulare 334-7353447

e-mail: ale.main@tiscali.it

### LEGENDA

ACC = acciaio	ARL = argento liscio Ral 9006	BR = bronzo	GOLD = verniciato ORO	NE = nero Ral 9005	RO = rosso Ral 3003
ALL = alluminio	AV = avorio Ral 1013	CM2 = centimetri quadrati	IX DEC = acciaio inox decorato	OB = ottone brunito	RU = ruggine
AM = argento metallizzato	AZ = azzurro Ral 5015	FE = ferro	IX LI = acciaio inox liscio	OL = ottone lucido	SA = sabbia
AN = anodizzato	BI = bianco Ral 9016	GH = grigio antracite Ral 7016	LZ = lamiera elettrozincata	ORO = colore oro	VE = verde Ral 6005
AR = argento	BRant = bronzo antico	GI = giallo Ral 1003	ML = metro lineare	PF = pressofuso	VR = verniciato



# ALUBOX

Cassette Postali - Mailboxes

**ALUBOX s.r.l**

Via Boaria, 5 - 40065 Pianoro - Bologna - Italy

tel. +39 051 743 565 - fax +39 051 744 010 - [info@alubox.it](mailto:info@alubox.it) - [www.alubox.it](http://www.alubox.it)