







Stender
in tubo tondo



STG001



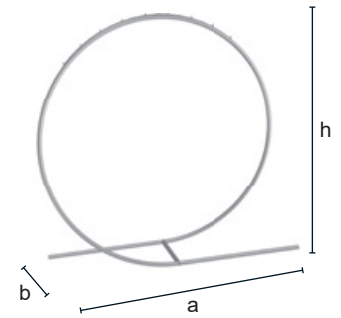

Stender tondo dalla geometria essenziale, in tubo Ø 30 mm
Round garment rails of essential geometry, in tube Ø 30 mm
Portant ronde à géométrie essentielle en tube Ø 30mm.
Вешало круглое по эссенциальной геометрии из трубы Ø 30 мм.

STG001	
 mm	h = 1600 a = 1600 b = 550
 Kg	11,00
 Pcs	40/pallet
	VS V
€	160,00 126,00



STG002

Stender rettangolare grande dalla geometria essenziale, in tubo Ø 30 mm
Big-size rectangular garment rails of essential geometry, in tube Ø 30 mm.
Portant rectangulaire grande à géométrie essentielle en tube Ø 30mm.
Вешало прямоугольное большое по эссенциальной геометрии из трубы Ø 30 мм.

STG002	
 mm	h = 1600 a = 1500 b = 550
 Kg	12,50
 Pcs	40/pallet
	VS V
€	140,00 95,00

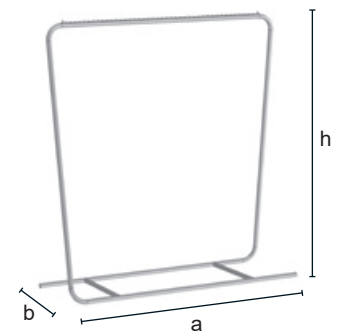



4.1 stender TT

4.1 stender TT



STG003

Stender rettangolare piccolo dalla geometria essenziale, in tubo Ø 30 mm
 Small-size rectangular garment rails of essential geometry, in tube Ø 30 mm.
 Petit portant rectangulaire à géométrie essentielle en tube Ø 30mm.
 Вешало прямоугольное маленькое по эссенциальной геометрии из трубы Ø 30 мм.



	STG003	
	h = 1600	
	a = 900	
	b = 550	
	Kg 9,00	
	Pcs 40/pallet	
	VS	V
	€ 130,00	91,00

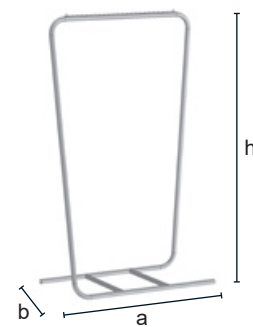

4.1 stender TT

4.1 stender TT

**ST010R50F**

Ruote Ø 50 mm / Wheels Ø 50 mm
Roues Ø 50 mm / Колеса Ø 50 мм

ST010R80F

Ruote Ø 80 mm / Wheels Ø 80 mm
Roues Ø 80 mm / Колеса Ø 80 мм

Stender semplice fisso, larghezza cm 150. Tubo Ø 30 mm.
Fixed single clothes stand, width cm 150. Tube Ø 30 mm.
Porte-vêtements simple fixe, largeur cm 150. Tube Ø 30 mm.
Вешало простое фиксированное, ширина 150 см. Труба Ø 30 мм.

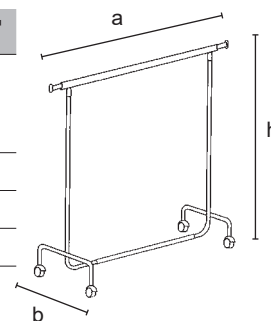

	ST010R50F	ST010R80F
	h = 1490 a = min 1500 max 2200 b = 570	h = 1540 a = min 1500 max 2200 b = 570
	6,80	7,60
	50/pallet	50/pallet
	CR	CR
€	51,00	54,00

**ST012R50F**

Ruote Ø 50 mm / Wheels Ø 50 mm
Roues Ø 50 mm / Колеса Ø 50 мм

ST012R80F

Ruote Ø 80 mm / Wheels Ø 80 mm
Roues Ø 80 mm / Колеса Ø 80 мм

Stender semplice fisso, larghezza cm 100. Tubo Ø 30 mm.
Fixed single clothes stand, width cm 100. Tube Ø 30 mm.
Porte-vêtements simple fixe, largeur cm 100. Tube Ø 30 mm.
Вешало простое фиксированное, ширина 100 см. Труба Ø 30 мм.

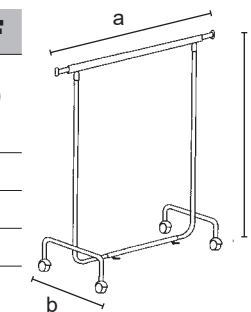

	ST012R50F	ST012R80F
	h = 1495 a = min 1000 max 1700 b = 570	h = 1540 a = min 1000 max 1700 b = 570
	6,00	6,80
	50/pallet	50/pallet
	CR	CR
€	45,00	49,00

**ST010R50R**

Ruote Ø 50 mm / Wheels Ø 50 mm
Roues Ø 50 mm / Колеса Ø 50 мм

ST010R80R

Ruote Ø 80 mm / Wheels Ø 80 mm
Roues Ø 80 mm / Колеса Ø 80 мм

Stender semplice ad altezza regolabile, larghezza cm 150. Tubo Ø 30 mm. Bloccaggio con sistema sistema "A" oppure "B".
Adjustable single clothes stand, width cm 150. Tube Ø 30 mm. Clamping with system "A" or "B".
Porte-vêtements simple réglable, largeur cm 150. Tube Ø 30 mm. Blocage avec système "A" ou "B".
Вешало простое с регулируемой высотой, ширина 150 см. Труба Ø 30 мм. Блокировка по системе "A" или "B".



Sistema "A"



Sistema "B"

	ST010R50R	ST010R80R
	h = min 1300 max 2030 a = min 1500 max 2200 b = 570	h = min 1350 max 2000 a = min 1500 max 2200 b = 570
	7,70	8,50
	50/pallet	50/pallet
	CR	CR
"A" €	56,00	59,00
"B" €	60,00	63,00

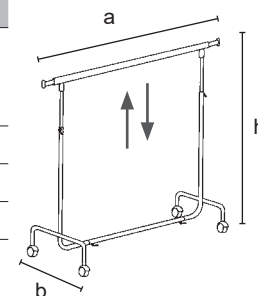
**ST012R50R**

Ruote Ø 50 mm / Wheels Ø 50 mm
Roues Ø 50 mm / Колеса Ø 50 мм

ST012R80R

Ruote Ø 80 mm / Wheels Ø 80 mm
Roues Ø 80 mm / Колеса Ø 80 мм

Stender semplice ad altezza regolabile, larghezza cm 100. Tubo Ø 30 mm. Bloccaggio con sistema sistema "A" oppure "B".
Adjustable single clothes stand, width cm 100. Tube Ø 30 mm. Clamping with system "A" or "B".
Porte-vêtements simple réglable, largeur cm 100. Tube Ø 30 mm. Blocage avec système "A" ou "B".
Вешало простое с регулируемой высотой, ширина 100 см. Труба Ø 30 мм. Блокировка по системе "A" или "B".



Sistema "A"



Sistema "B"

	ST012R50R	ST012R80R
	h = min 1300 max 2030 a = min 1000 max 1700 b = 570	h = min 1350 max 2000 a = min 1000 max 1700 b = 570
	6,90	7,70
	100/pallet	100/pallet
	CR	CR
"A" €	51,00	54,00
"B" €	55,00	58,00

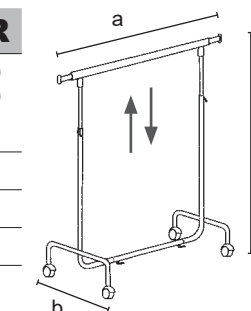

4.1 stender TT

4.1 stender TT

ST150 - (ST010R50-80F)

ST100 - (ST012R50-80F)

Barra intermedia regolabile in altezza per stender in tubo Ø 30 mm.
 Height-adjustable middle bar for stender tube Ø 30 mm.
 Barre intermediaire pour penderie en tube Ø 30 mm.
 Центральная перекладина, регулируемая по высоте, для вешала из трубы Ø 30 мм.



M	ST150	ST100
	a = 1360 b = 50 c = 30	a = 860 b = 50 c = 30
mm		
	2,00	0,85
	300/pallet	300/pallet
	CR	CR
€	19,00	18,00

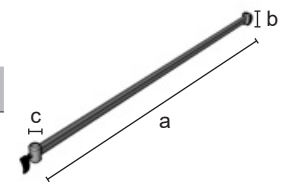

ST150R - (ST010R50R)

ST100R - (ST012R50R)

Barra intermedia regolabile in altezza per stender. Bloccaggio con sistema sistema "A" oppure "B".
 Height-adjustable middle bar for stender. Clamping with system "A" or "B".
 Barre intermediaire pour penderie. Blocage avec système "A" ou "B".
 Центральная перекладина, регулируемая по высоте, для вешала. Блокировка по системе "A" или "B".



M	ST150R	ST100R
	a = 1360 b = 50 c = 26	a = 860 b = 50 c = 26
mm		
	2,00	0,85
	300/pallet	300/pallet
	CR	CR
"A" €	20,00	18,00
"B" €	24,00	22,00

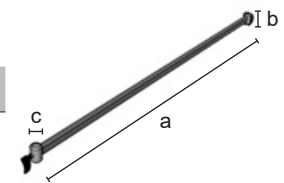
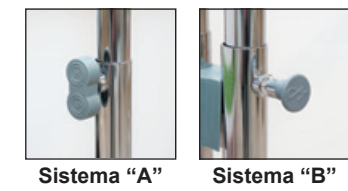

ST11PRO

Coppia prolunghe per spalle stender ST010R50-80F / ST012R50-80F, servono per aumentare l'altezza dello stender agevolando l'uso della barra intermedia.
 Legs extensions for coat-rack ST010R50-80F / ST012R50-80F, necessary to increase the height of the coat-rack facilitating the use of the middle bar.
 Couple de rallonges pour montants de la penderie ST010R50-80F / ST012R50-80F, utilisees pour augmenter l'hauteur de la penderie et faciliter l'utilisation de la barre intermediaire.
 Пара удлинителей для стоек вешала ST010R50-80F / ST012R50-80F. Данные удлинители необходимы для регулирования высоты вешала, облегчая использование центральной перекладины.



M	ST11PRO
	h = 500 a = 28
mm	
	1,20
	50/box
	CR
€	7,50 (2 pcs)

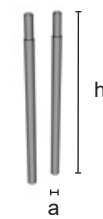

4.1 stender TT

4.1 stender TT

**ST011R50F (ST010R50F + ST11PRO + ST150)**

Ruote Ø 50 mm / Wheels Ø 50 mm
Roues Ø 50 mm / Колеса Ø 50 мм

ST011R80F (ST010R80F + ST11PRO + ST150)

Ruote Ø 80 mm / Wheels Ø 80 mm
Roues Ø 80 mm / Колеса Ø 80 мм

Stender doppio fisso, larghezza cm 150. Tubo Ø 30 mm. Barra centrale regolabile a tutta altezza predisposta per il fissaggio all'altezza desiderata. Bloccaggio a levetta. Fixed double clothes stand, width cm 150. Tube Ø 30 mm. Central rail which can be fixed along all height for clamping. Clamping by means of levers.

Porte-vêtements double fixe, largeur cm 150. Tube Ø 30 mm. Barre centrale réglable à toute hauteur pour le blocage. Blocage à doigts.

Вешало двойное фиксированное, ширина 150 см. Труба Ø 30 мм. Регулируемая центральная перекладина. Блокировка при помощи втулок.

	ST011R50F	ST011R80F
	h = 1940 a = min 1500 max 2200 b = 570	h = 1990 a = min 1500 max 2200 b = 570
	8,80	9,60
	50/pallet	50/pallet
	CR	CR
€	76,00	80,00

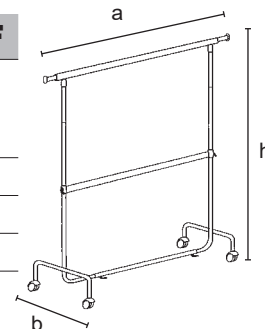
**ST013R50F (ST012R50F + ST11PRO + ST100)**

Ruote Ø 50 mm / Wheels Ø 50 mm
Roues Ø 50 mm / Колеса Ø 50 мм

ST013R80F (ST012R80F + ST11PRO + ST100)

Ruote Ø 80 mm / Wheels Ø 80 mm
Roues Ø 80 mm / Колеса Ø 80 мм

Stender doppio fisso, larghezza cm 100. Tubo Ø 30 mm. Barra centrale regolabile a tutta altezza predisposta per il fissaggio all'altezza desiderata. Bloccaggio a levetta. Fixed double clothes stand, width cm 100. Tube Ø 30 mm. Central rail which can be fixed along all height for clamping. Clamping by means of levers.

Porte-vêtements double fixe, largeur cm 100. Tube Ø 30 mm. Barre centrale réglable à toute hauteur pour le blocage. Blocage à doigts.

Вешало двойное фиксированное, ширина 100 см. Труба Ø 30 мм. Регулируемая верхняя перекладина. Блокировка при помощи втулок.

	ST013R50F	ST013R80F
	h = 1940 a = min 1000 max 1700 b = 570	h = 1990 a = min 1000 max 1700 b = 570
	7,60	8,50
	50/pallet	50/pallet
	CR	CR
€	70,00	73,00

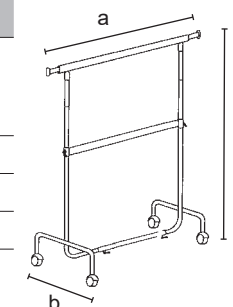
**ST011R50R (ST010R50R + ST150R)**

Ruote Ø 50 mm / Wheels Ø 50 mm
Roues Ø 50 mm / Колеса Ø 50 мм

ST011R80R (ST010R80R + ST150R)

Ruote Ø 80 mm / Wheels Ø 80 mm
Roues Ø 80 mm / Колеса Ø 80 мм

Stender doppio, larghezza cm 150. Tubo Ø 30 mm. Barra centrale e superiore regolabile. Bloccaggio con sistema sistema "A" oppure "B".

Double clothes stand, width cm 150. Tube Ø 30 mm. Central and upper adjustable rail. Clamping with system "A" or "B".

Porte-vêtements double, largeur cm 150. Tube Ø 30 mm. Barre centrale et supérieure réglable. Blocage avec système "A" ou "B".

Вешало двойное, ширина 150 см. Труба Ø 30 мм. Регулируемые центральная и верхняя перекладины. Блокировка по системе "A" или "B".

	ST011R50R	ST011R80R
	h = min 1300 max 2030 a = min 1500 max 2200 b = 570	h = min 1350 max 2000 a = min 1500 max 2200 b = 570
	9,70	10,50
	50/pallet	50/pallet
	CR	CR
"A" €	75,00	79,00
"B" €	84,00	87,00

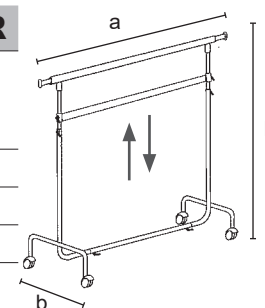

Sistema "A"

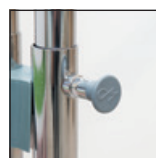

Sistema "B"

alcalain MC

**ST013R50R (ST012R50R + ST100R)**

Ruote Ø 50 mm / Wheels Ø 50 mm
Roues Ø 50 mm / Колеса Ø 50 мм

ST013R80R (ST012R80R + ST100R)

Ruote Ø 80 mm / Wheels Ø 80 mm
Roues Ø 80 mm / Колеса Ø 80 мм

Stender doppio, larghezza cm 100. Tubo Ø 30 mm. Barra centrale e superiore regolabile. Bloccaggio con sistema sistema "A" oppure "B".

Double clothes stand, width cm 100. Tube Ø 30 mm. Central and upper adjustable rail. Clamping with system "A" or "B".

Porte-vêtements double, largeur cm 100. Tube Ø 30 mm. Barre centrale et supérieure réglable. Blocage avec système "A" ou "B".

Вешало двойное, ширина 100 см. Труба Ø 30 мм. Регулируемые центральная и верхняя перекладины. Блокировка по системе "A" или "B".

	ST013R50R	ST013R80R
	h = min 1300 max 2030 a = min 1000 max 1700 b = 570	h = min 1350 max 2000 a = min 1000 max 1700 b = 570
	8,60	9,30
	100/pallet	100/pallet
	CR	CR
"A" €	68,00	71,00
"B" €	76,00	80,00

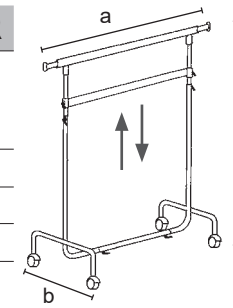

Sistema "A"

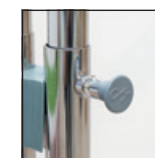

Sistema "B"

alcalain MC

4.1 stender TT

4.1 stender TT

**ST014R80F**

Ruote Ø 80 mm / Wheels Ø 80 mm
Roues Ø 80 mm / Колеса Ø 80 мм

Stender semplice fisso con barra superiore per carichi pesanti. Larghezza 1500 mm, tubo Ø 30 mm.
Fixed single clothes stand with upper bar for heavy loadings. Width 1500 mm, tube Ø 30 mm.
Porte-vêtements fixe avec barre supérieure pour charges lourdes. Largeur 1500 mm, tube Ø 30 mm
Вешало простое фиксированное с верхней перекладиной для тяжелой одежды. Ширина 1500 мм, труба Ø 30 мм.

	ST014R80F
	h = 1580 a = min 1500 max 2200 b = 500
	7,60
	50/pallet
	CR
	€ 71,00

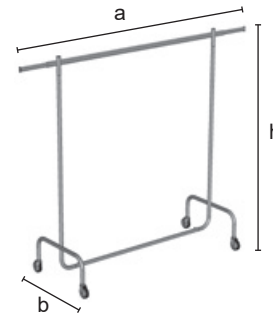
**ST014R80R**

Ruote Ø 80 mm / Wheels Ø 80 mm
Roues Ø 80 mm / Колеса Ø 80 мм

Stender semplice ad altezza regolabile con barra superiore per carichi pesanti. Larghezza 1500 mm, tubo Ø 30 mm. Bloccaggio con sistema "A" oppure "B".
Height-adjustable clothes stand with upper bar for heavy loadings. Width 1500 mm, tube Ø 30 mm. Clamping with system "A" or "B".
Porte-vêtements réglable en hauteur avec barre supérieure pour charges lourdes. Largeur 1500 mm, tube Ø 30 mm. Blocage avec système "A" ou "B".
Вешало простое, регулируемое по высоте, с верхней перекладиной для тяжелой одежды. Ширина 1500 мм, труба Ø 30 мм. Блокировка по системе "A" или "B".

	ST014R80R
	h = min 1250 max 2000 a = min 1500 max 2200 b = 500
	8,50
	50/pallet
	CR
	"A" € 76,00
	"B" € 81,00

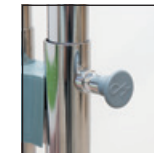
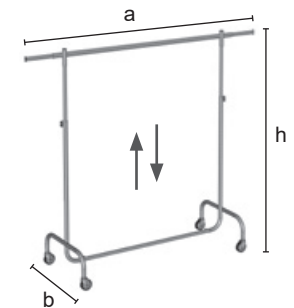

Sistema "A"

Sistema "B"

ST209R80B

Stender a doppia barra regolabile in altezza. Ruote Ø80 di cui 2 con freno. Lunghezza cm 150. Lo stender è munito di prolunghe sulle barre appendieria.
Height-adjustable clothes-stand with double bar. Width 150cm, wheels Ø80, two of which with brake. Upper bar with extensions.
Penderie réglable en hauteur avec double barre. Largeur 150cm, roulettes Ø80, deux avec freins.
Вешало с двойным выступом, регулируемое по высоте. Колеса Ø80, из которых 2 имеют блокировку. Длина 150 см. Вешало имеет планку-вешало с удлинителями.

	ST209R80B
	h = min 1250 max 2000 a = min 1500 max 2000 b = 530
	13,00
	40/pallet
	CR
	€ 99,00

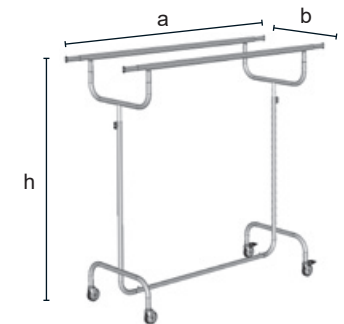

4.1 stender TT







4.1 stender TT

**GIDKIT20**

Stender realizzati con tubi e giunti Idroshop Ø 28 mm. Disponibili in altezza regolabile. Viene fornita la struttura in metallo completamente smontata.

Height-adjustable garment rail realized with Idroshop tubes and joints Ø 28 mm. Supplied in KD form.

Portant réalisé avec tubes et joints Idroshop Ø 28 mm. Hauteur réglable, livré démonté. Вешало из трубы и крепежей Idroshop Ø 28 мм. Регулируемое по высоте. Поставляется в наборе для сборки.

	GIDKIT20
	h = min 1200 max 2000 a = 1200 b = 450
	13,80
	50/pallet
	ZN
	85,00







**GIDKIT55**

Stender realizzati con tubi e giunti Idroshop Ø 28 mm. Disponibili in altezza fissa su 2 livelli. Viene fornita la struttura in metallo completamente smontata.

Garment rail realized with Idroshop tube and joints Ø 28 mm. Available in fixed height, 2 levels. Supplied in KD form.

Portant réalisé avec tubes et joints idroshop Ø 28 mm. Disponible en hauteur fixe, 2 niveaux. Livré démonté.

Вешало из трубы и крепежей Idroshop Ø 28 мм. Фиксированное по высоте на 2-х уровнях. Поставляется в наборе для сборки.



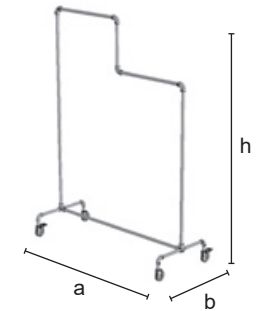



	GIDKIT55
	h = min 1600 max 2000 a = 1200 b = 450
	11,00
	50/pallet
	ZN
	85,00

**GIDKIT21**

Stender realizzati con tubi e giunti Idroshop Ø 28 mm. Disponibili in altezza fissa. Viene fornita la struttura in metallo completamente smontata.

Garment rail realized with Idroshop tubes and joints Ø 28 mm. Fixed height, supplied in KD form.

Portant réalisé avec tubes et joints Idroshop Ø 28 mm. Hauteur fixe, livré démonté. Вешало из трубы и крепежей Idroshop Ø 28 мм. Фиксированное по высоте. Поставляется в наборе для сборки.

	GIDKIT21
	h = 1600 a = 1200 b = 450
	10,00
	50/pallet
	ZN
	80,00

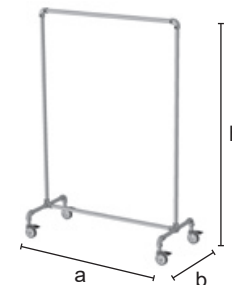

4.1 stender TT

4.1 stender TT





**ST008R80F**

Stender in altezza fissa, completamente smontabile. La posizione rialzata della barra inferiore permette di accatastare gli stender in poco spazio senza doverli smontare. La barra appenderia è sempre cromata, mentre il resto della struttura può essere cromato o verniciato nei colori a campionario.

Garment rail with fixed height, fully demountable. The special connecting lower base allows the rails to be easily stacked when not in use. The upper bar is always supplied in chrome finishing while the structure can be in chrome finishing or laquered in the colours of our range.

Portant avec hauteur fixe, totalement pliable. La position élevée de la barre de jonction inférieure permet d'empiler les portants dans peu d'espace sans les démonter. La barre supérieure est toujours chromé, la structure peut être chromé ou laqué dans les coloris de notre gamme.

Вешало фиксированное, полностью разборное. Приподнятая нижняя перекладина, позволяет складировать вешала на минимальном пространстве, без необходимости их разборки. Планка-вешало и регулируемые стойки имеют только отделку хром, а база может быть окрашена, согласно гамме цветов по каталогу.

	ST008R80F	
	h = 1600	
	a = 1500	
	b = 540	
mm		
	7,70	
Kg		
	75/pallet	
Pcs		
	CR - VS	V
€	58,00	56,00

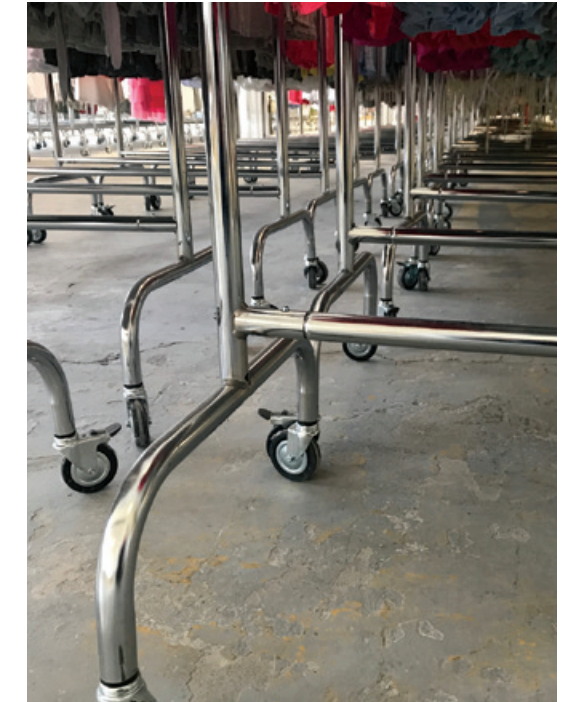
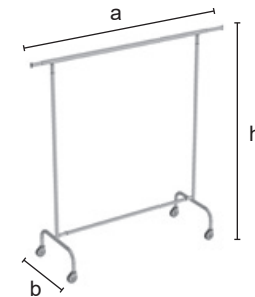



**ST008R80R**

Stender in altezza regolabile, completamente smontabile. La posizione rialzata della barra inferiore permette di accatastare gli stender in poco spazio senza doverli smontare. La barra appenderia e i montanti scorrevoli sono sempre cromati, mentre il resto della struttura può essere cromato o verniciato nei colori a campionario.

Height-adjustable garment rail, fully demountable. The special connecting lower base allows the rails to be easily stacked when not in use. The upper bar is always supplied in chrome finishing while the structure can be in chrome finishing or laquered in the colours of our range.

Portant avec hauteur réglable, totalement pliable. La position élevée de la barre de jonction inférieure permet d'empiler les portants dans peu d'espace sans les démonter. La barre supérieure est toujours chromé, la structure peut être chromé ou laqué dans les coloris de notre gamme.

Вешало, регулируемое по высоте, полностью разборное. Приподнятая нижняя перекладина, позволяет складировать вешала на минимальном пространстве, без необходимости их разборки. Планка-вешало и регулируемые стойки имеют только отделку хром, а база может быть окрашена, согласно гамме цветов по каталогу.

	ST008R80R	
	h = min 1400 max 2000	
	a = 1500	
	b = 540	
mm		
	8,00	
Kg		
	75/pallet	
Pcs		
	CR - VS	V
€	63,00	61,00

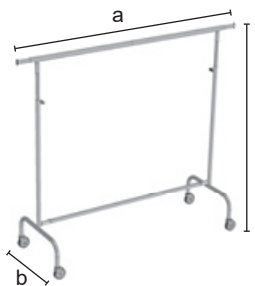

4.1 stender TT

4.1 stender TT

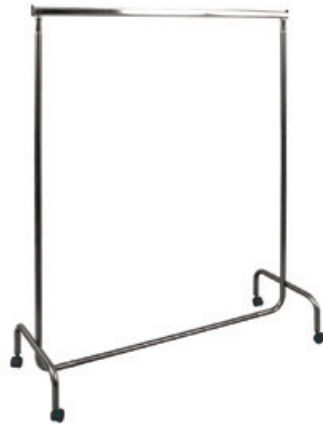
**SST05EC**

Ruote Ø 50 mm / Wheels Ø 50 mm
Roues Ø 50 mm / Колеса Ø 50 мм

Stender in tubo Ø 25 cromato o verniciato, larghezza 1200 mm., altezza fissa.
Clothes-stand in tube Ø 25, width 1200 mm. Fixed height. Chromed or laquered finishing.
Penderie en tube Ø 25, largeur 1200 mm. Hauteur fixe. Finition chromée ou laquée.
Вешало из трубы Ø 25, ширина 1200 мм., фиксированная высота. Отделка хром или краска.

SST05EC	
	h = 1500 a = 1200 b = 570
	6,50
	50/pallet
	CR - VS V
€	49,00 40,00

**SST004**

Ruote Ø 50 mm / Wheels Ø 50 mm
Roues Ø 50 mm / Колеса Ø 50 мм

Stender porta confezioni per bambino, larghezza regolabile mm 700/1200, altezza regolabile.
Finitura cromata. Bloccaggio con sistema sistema "A" oppure "B".
Clothes-stand with adjustable width 700/1200 mm. Height-adjustable, chrome-plated finishing. Clamping with system "A" or "B".
Petite penderie avec largeur réglable 700/1200 mm. Hauteur réglable, finition chromé.
Blocage avec système "A" ou "B".
Вешало для детской одежды хромированное, с регулируемой высотой, ширина 700/1200 мм. Блокировка по системе "А" или "В".

SST004	
	h = min 1130 max 1900 a = min 850 max 1560 b = 600 c = 360
	5,40
	60/pallet
	CR
"A" €	52,00
"B" €	56,00

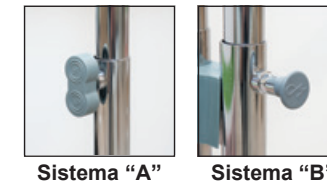
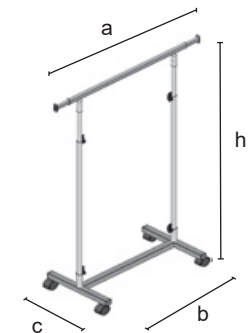

Sistema "A"

Sistema "B"

ST070PR / ST070R50

Stender a doppia barra, regolabile in altezza.
Adjustable double overhanging clothes-stand.
Porte-vêtements à double saillie réglable en hauteur.
Вешало с двойным выступом с регулируемой высотой.

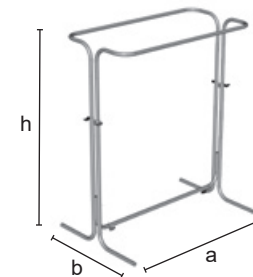

ST070PR		ST070R50	
	h = min 1100 max 2000 a = 1300 b = 630	h = min 1100 max 2000 a = 1300 b = 630	
	10,50	10,50	
	40/pallet	40/pallet	
	CR	CR	
€	120,00	127,00	

**ST009R50R**

Ruote Ø 50 mm / Wheels Ø 50 mm
Roues Ø 50 mm / Колеса Ø 50 мм

Stender smontabile con base intera, regolabile in altezza e barra appenderia allungabile.
Bloccaggio con sistema sistema "A" oppure "B".
Adjustable clothes stand with whole base. Upper adjustable rail. Clamping with system "A" or "B".
Porte-vêtements réglable avec base entière. Barre supérieure réglable. Blocage avec système "A" ou "B".
Вешало разборное с целой базой и регулируемой высотой и выдвижной планкой. Блокировка по системе "А" или "В".

ST009R50R	
	h = min 1120 max 1850 a = min 970 max 1700 b = 500 c = 830
	5,90
	50/pallet
	CR
"A" €	54,00
"B" €	58,00

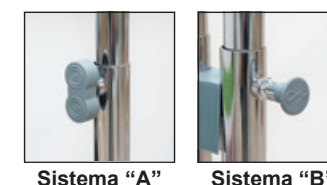
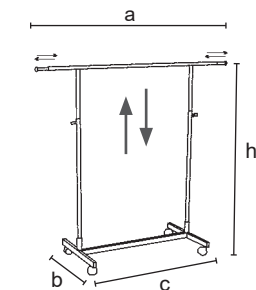

Sistema "A"

Sistema "B"

4.1 stender TT

4.1 stender TT



ST012VTMA

Espositore con barra appendiera ad altezza fissa, e cesto regolabile in altezza. Finitura cromato. L'espositore viene fornito smontato.
 Stand with clothes-bar and height-adjustable basket. Chrome finishing. It is supplied unassembled.
 Présentoir avec barre porte-vêtements à hauteur fixe et panier réglable en hauteur. Finition chromé. Livré démonté.
 Экспозитор с фиксированной планка-вешало и корзиной, регулируемой по высоте. Отделка хром. Поставляется в разобранном виде.



	ST012VTMA
	h = 1600 a = min 1000 max 1400 b = 500
	8,60
	1/pallet
	CR
€	80,00

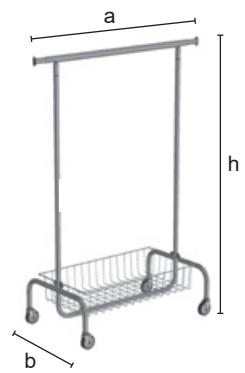

ST012VTMB

Espositore a cesti regolabili in altezza. Finitura cromato. L'espositore viene fornito smontato.
 Stand with height-adjustable baskets. Chrome finishing. It is supplied unassembled.
 Présentoir à paniers réglables en hauteur. Finition chromé. Livré démonté.
 Экспозитор с корзинами, регулируемые по высоте. Отделка хром. Поставляется в разобранном виде.



	ST012VTMB
	h = 1600 a = 1000 b = 500
	11,00
	1/pallet
	CR
€	139,00



4.1 stender TT

4.1 stender TT



ST030PR

Con piedini / With feet
Avec pieds / С ножками

ST030R50R

Ruote Ø 50 mm / Wheels Ø 50 mm
Roues Ø 50 mm / Колеса Ø 50 mm

Stender a colonna con quattro braccia sporgenti e inclinate a 25° regolabili in altezza ed indipendenti. Bloccaggio regolazione a levetta.
Column clothes stand with four adjustable independent overhanging arms inclined at 25°. Clamping adjustment by means of levers.
Porte-vêtements à colonne avec quatre bras saillants inclinés à 25° réglables en hauteur et indépendants. Blocage réglable à doigts.
Вешало в виде колонны с четырьмя выступающими под углом 25° кронштейнами с независимо регулируемой высотой. Блокировка при помощи втулок.

	ST030PR	ST030R50R
h = min 1100 max 1800	h = min 1100 max 1800	h = min 1100 max 1800
mm	10,10	10,10
Kg	10,10	10,10
Pcs	50/pallet	50/pallet
CR	CR	CR
€	114,00	116,00

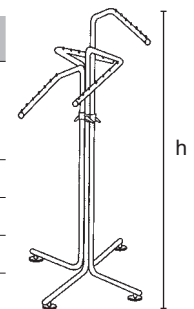

ST032PR

Con piedini / With feet
Avec pieds / С ножками

ST032R50R

Ruote Ø 50 mm / Wheels Ø 50 mm
Roues Ø 50 mm / Колеса Ø 50 mm

Stender a colonna con quattro braccia sporgenti laterali a 90° regolabili in altezza ed indipendenti. Bloccaggio regolazione a levetta.
Column clothes stand with four adjustable independent side overhanging arms inclined at 90°. Clamping adjustment by means of levers.
Porte-vêtements à colonne avec quatre bras latéraux saillants inclinés à 90° réglables en hauteur et indépendants. Blocage réglable à doigts.
Вешало в виде колонны с четырьмя боковыми выступающими под углом 90° кронштейнами с независимо регулируемой высотой. Блокировка при помощи втулок.

	ST032PR	ST032R50R
h = min 1100 max 1800	h = min 1100 max 1800	h = min 1100 max 1800
mm	10,00	10,00
Kg	10,00	10,00
Pcs	50/pallet	50/pallet
CR	CR	CR
€	110,00	112,00

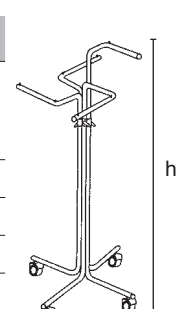

ST031PR

Con piedini / With feet
Avec pieds / С ножками

ST031R50R

Ruote Ø 50 mm / Wheels Ø 50 mm
Roues Ø 50 mm / Колеса Ø 50 mm

Stender a colonna con tre braccia inclinate a 25° regolabili in altezza ed indipendenti. Bloccaggio regolazione a levetta.
Column clothes stand with three adjustable independent arms inclined at 25°. Clamping adjustment by means of levers.
Porte-vêtements à colonne avec trois bras inclinés à 25° réglables en hauteur et indépendants. Blocage réglable à doigts.
Вешало в виде колонны с тремя выступающими под углом 25° кронштейнами с независимо регулируемой высотой. Блокировка при помощи втулок.

	ST031PR	ST031R50R
h = min 1100 max 1800	h = min 1100 max 1800	h = min 1100 max 1800
mm	7,00	7,00
Kg	7,00	7,00
Pcs	100/pallet	100/pallet
CR	CR	CR
€	86,00	87,00

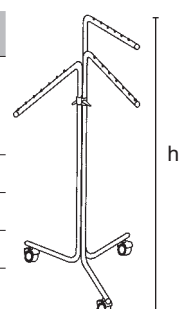





4.1 stender TT

4.1 stender TT

**ST042R50F**

Ruote Ø 50 mm / Wheels Ø 50 mm
Roues Ø 50 mm / Колеса Ø 50 mm



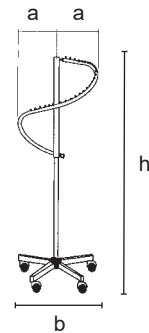

Stender a spirale continua doppia.
Adjustable double spiral clothes stand.
Porte-vêtements à spirale double.
Вешало с двойной непрерывной спиралью.

ST042R50F	
	h = 1650 a = 680 b = 600
	8,20
	25/pallet
	CR
€	135,00

**ST050R50A**

Anello Ø 800 / Ring Ø 800
Anneau Ø 800 / Кольцо Ø 800



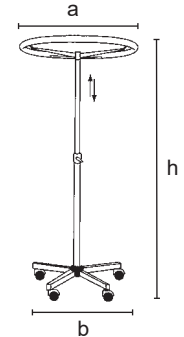

Stender circolare ad un solo cerchio Ø 800 mm rotante su anello in nylon. Bloccaggio regolazione a clips.
Circular clothes stand with a single circle Ø 800 rotating on a nylon ring. Clamping adjustment by clips.
Porte-vêtements circulaire à un seul circle Ø 800 roulant sur un anneau en nylon. Blocage réglables à doigts.
Вешало круглое с одной окружностью Ø 800 или 1000 мм, вращающейся на нейлоновом колесике. Блокировка при помощи клипсы.

ST050R50A	
	h = min 1200 max 2000 a = 800 b = 800
	12,70
	20/pallet
	CR
€	161,00

**ST054R50R**

Anello Ø 800 / Ring Ø 800
Anneau Ø 800 / Кольцо Ø 800

Stender circolare a doppio cerchio Ø 800 mm rotante su anello in nylon. Bloccaggio regolazione a levetta.
Circular clothes stand with a double circle Ø 800 rotating on a nylon ring. Clamping adjustment by means of levers.
Porte-vêtements circulaire à double circle Ø 800 roulant sur un anneau en nylon. Blocage réglable à doigts.
Вешало круглое с двумя окружностями Ø 800, вращающимися на нейлоновом колесике. Блокировка при помощи втулки.

ST054R50R	
	h = min 1250 max 2000 a = 800 b = 800
	17,50
	15/pallet
	CR
€	248,00

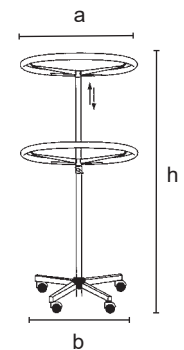





4.1 stender TT

4.1 stender TT

**ST051R50R**



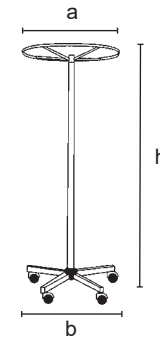

Ruote Ø 50 mm / Wheels Ø 50 mm
Roues Ø 50 mm / Колеса Ø 50 мм

Stender circolare ad un solo cerchio Ø 600 mm rotante su anello in nylon. Bloccaggio regolazione a levette.
Circular clothes stand with a single circle Ø 600 mm rotating on a nylon ring. Clamping adjustment by means of levers.
Porte-vêtements circulaire à un seul circle Ø 600 mm roulant sur un anneau en nylon. Blocage réglable à doigts.
Вешало круглое с одной окружностью Ø 600 мм, вращающейся на нейлоновом колесике. Блокировка при помощи втулки.

	ST051R50R
	h = 1650 a = 600 b = 600
mm	
	7,30
	50/pallet
	CR
€	140,00

**ST055**



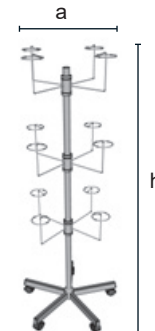

Stender portacapelli, con tre supporti a quattro braccia regolabili in altezza. I 12 supporti hanno l'appoggio in poliuretano a cellule aperte di colore grigio. Lo stender è montato su una base a 5 razze con ruote gemellari Ø50. Finitura cromata.
Hat-holder stand with three height-adjustable supports with 4 arms each. The twelve hat-supports are made by soft polyurethane, grey finishing. The stand has a 5-spoked base with wheels Ø50. Chrome finishing.
Presentoir porte-chapeaux avec trois supports à 4 bras, réglables en hauteur. Les douze supports porte-chapeaux sont en caoutchouc-mousse, couleur gris. La base est à 5-bras avec roulettes d.50mm. Finition chromé.
Вешало для шляп, с тремя основаниями, регулируемые по высоте. На каждой основе расположены четыре кронштейна. 12 опор из пористого мягкого полиуретана темно-серого цвета. Вешало имеет 5-осевую базу с колесами Ø50. Отделка хром.

	ST055
	h = 1650 a = 600
mm	
	7,00
	15/pallet
	CR
€	160,00

alcalain **ST052R50R**





Ruote Ø 50 mm / Wheels Ø 50 mm
Roues Ø 50 mm / Колеса Ø 50 мм

Stender portacinture circolare regolabile a 8 astine.
Adjustable circular belt-holder with 8 spokes.
Porte-ceintures circulaire réglable en hauteur avec 8 tiges.
Вешало для ремней регулируемое, с 8 рукавами.

	ST052R50R
	h = 1650 a = 600
mm	
	6,30
	20/pallet
	CR
€	106,00

**ST057**

Stender portacinture con doppia corona circolare a 8 aste. Le corone sono regolabili in altezza in modo indipendente.
Belt-holder stand with two crowns at 8 spokes. The crowns are height-adjustable.
Penderie porte-ceintres avec deux couronnes à 8 tiges. Les couronnes sont réglables en hauteur.
Вешало для ремней с двумя круговыми вертушками с 8 осями-экспозиторами. Вертушки регулируются в высоту независимо друг от друга.

	ST057
	h = 1650 a = 600
mm	
	8,00
	15/pallet
	CR
€	153,00

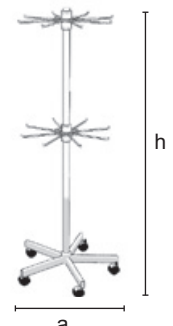
alcalain 



4.1 stender TT

4.1 stender TT



ST061R50F
 Ruote Ø 50 mm / Wheels Ø 50 mm
 Roues Ø 50 mm / Колеса Ø 50 mm

Stender porta scarpe a 5 piani.
 Shoes-holder with five levels.
 Porte-chaussures à 5 niveaux.
 Стойка для обуви с 5 уровнями.



	ST061R50F
	h = 1400 a = 1000
mm	
	11,80
	40/pallet
	CR
€	128,00



ST061D
 Ruote Ø 80 mm / Wheels Ø 80 mm
 Roues Ø 80 mm / Колеса Ø 80 mm

Gondola porta scarpe bi-facciale. I ripiani in griglia sono inclinabili. La finitura è cromata.
 Double-sided Gondola system for shoes. The grid shelves are inclinable. Chrome finishing.
 Système Gondola porte-chaussures à double-face. Les étagères en grille sont inclinables. Finition chromée.
 Гондولا двусторонняя хромированная для обуви с наклонными полками из решетки.

	ST061D
	h = 1450 a = 1100 b = 500
mm	
	20,00
	1/pallet
	CR
€	235,00





4.1 stender TT

4.1 stender TT



GIDKIT3

Stender a 2 braccia realizzato con il sistema tubi e giunti della serie Idroshop. La struttura viene fornita in kit, con tubi tagliati e tutto il necessario per il montaggio.
 2-arms clothes-stand realized with tubes and joints of Idroshop collection. The structure is supplied as a kit, with cutted tubes and all the assembling tooling.
 Porte-vêtement à 2 bras réalisé avec tubes et joints de la collection Idroshop. La structure est livrée en Kit, avec les tubes déjà coupés et tout le nécessaire pour le montage.
 Вешало с 2 кронштейнами, монтируемое при помощи труб и крепежей серии IDROSHOP. Поставляется в наборе с нарезанными трубами и всем необходимым для сборки.



M	GIDKIT3
	h = 1300 a = 700 b = 450
	7,00
	50/pallet
	ZN
	65,00

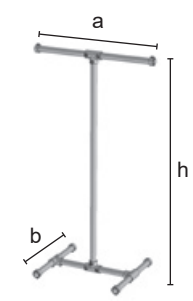

GIDKIT5

Stender realizzato con il sistema tubi e giunti della serie Idroshop. La struttura viene fornita in kit, con tubi tagliati e tutto il necessario per il montaggio.
 Clothes-stand realized with tubes and joints of Idroshop collection. The structure is supplied as a kit, with cutted tubes and all the assembling tooling.
 Portant réalisé avec tubes et joints de la collection Idroshop. La structure est livrée en Kit, avec les tubes déjà coupés et tout le nécessaire pour le montage.
 Вешало, монтируемое при помощи труб и крепежей серии IDROSHOP. Поставляется в наборе с нарезанными трубами и всем необходимым для сборки.



M	GIDKIT5
	h = 1580 a = 1560 b = 570
	14,00
	50/pallet
	ZN
	102,00

