

CAST & EXTRUDED SHEET

# Technical Brochure

**3 | INTRODUCTION**

Altuglas<sup>®</sup>, general properties, range of products, applications

**4 | PROPERTIES OF ALTUGLAS<sup>®</sup>**

## TABLE OF SPECIFICATION

General, mechanical, optical

Electrical, thermal and flammability properties

## OTHER PROPERTIES

Optical, acoustic, resistance to heat and to natural ageing properties

ALTUGLAS<sup>®</sup> CN AND ALTUGLAS<sup>®</sup> EX

Differences, range of applications, recycling possibilities

**10 | WORKING WITH ALTUGLAS<sup>®</sup>**

General

## STRAIGHT CUTTING

Cutting along a groove, bandsaw, circular saw

## CUTTING SHAPES

Bandsaw, jigsaw, milling, laser cutting, water-jet cutting

## OTHER FORM OF MACHINING

Drilling, turning, milling, engraving, sanding

Polishing, abrasive and flame polishing

## THERMOFORMING

Stoving, heating, moulds, thermoforming with or without drawing, bending

## GUIDELINES AND AVOIDING ERRORS

**27 | INSTALLATION**

General information, dimensional variation and expansion gaps  
selecting the sheet thickness, cold bending

**28 | ASSEMBLY**

Bonding, welding

**29 | DECORATIVE FINISHES**

Screenprinting, paint, adhesive films, illuminated decoration

**30 | FINISHING & MAINTENANCE**

Finishing, maintenance and cleaning, norms

**31 | RESISTANCE TO CHEMICALS**

Altuglas<sup>®</sup> behaviour table

**34 | ALTUGLAS<sup>®</sup> GUARANTEE**

# Introduction

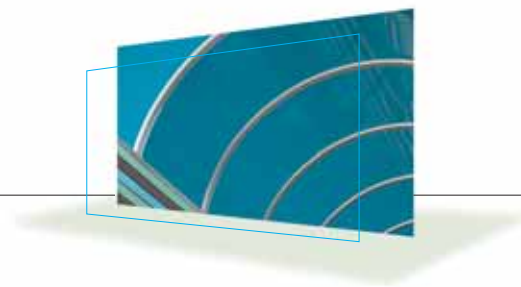

## THE ALTUGLAS® BRAND NAME

**Altuglas® is the Arkema registered trade name for PMMA (polymethylmethacrylate) products.**

Altuglas® is available in many forms:

- Cast and extruded sheets.
- Sanitaryware sheets.
- Resins.
- Extruded tubes, rods.
- Adhesives and auxiliary products.

## GENERAL PROPERTIES OF ALTUGLAS®

### Brief summary of properties:

Altuglas® is a rigid, transparent, thermoplastic material.

Naturally colourless and exceptionally clear, it can also be tinted for an almost infinite range of colours. The light transmission and diffusion parameters can be varied on request.

It is inert to many corrosive chemicals and is the plastic material of choice for outdoor use (resistant to UV and general weathering).

A wide variety of industrial, craft and artistic processes can be used to machine and shape Altuglas® sheet.

## THE RANGE

**The products described in this technical brochure are referred to as:**

- **ALTUGLAS® CN**, for cast sheet.
- **ALTUGLAS® EX**, for extruded sheet.

Sheets are available in a wide range of formats, thicknesses, colours and surface finishes. Detailed information on the various combinations, as well as delivery conditions, are given in the Altuglas® Product Catalogue.

**Sheets manufactured by Altuglas International meet the following standards:**

- **ALTUGLAS® CN**: ISO 7823.1 - 1998.
- **ALTUGLAS® EX**: ISO 7823.2 - 1997.

## APPLICATIONS

**Altuglas® CN and EX sheets are used in numerous applications:**

- **Signs and signboards:** Illuminated panels, 3D lettering, indicator panels, etc.
- **POS advertising:** Display stands, testers, notice-boards, etc.
- **Interior design:** Shop-fitting, furniture, projection screens, glazing, etc.
- **Architectural fittings:** street furniture, safety fittings, acoustic screens, skylights, etc.
- **Sanitaryware**<sup>(1)</sup>, bath tubes, shower trays, etc.
- **Transport:** Deflectors, sun visors, registration plates, ships' portholes and windows, etc.
- **Industry:** Machine guards, dials, precision parts, etc.
- **Medical:** Cribs, incubators, etc.

Many specialist applications can be added to this list, such as sun-beds, swimming pool shelters and barriers, etc.

<sup>(1)</sup> Applications such as baths, shower trays and basins require the use of special Altuglas® CS sheet (also known as cast sanitaryware sheet).

# Properties of Altuglas®

## TABLE OF SPECIFICATIONS

	Main characteristics			Indicative values				
	TEST METHOD			UNITS	ALTUGLAS® CN		ALTUGLAS® EX	
	ISO	NF	Others		Thickness mm	Value	Thickness mm	Value
<b>GENERAL PROPERTIES</b>								
Water absorption, 24 hrs.	62	T 51002	DIN 53495	%	4	0.30	4	0.30
Water absorption, 8 days	62	T 51002	DIN 53495	%	4	0.50	4	0.50
Water absorption, max. (Total immersion, 1200 hrs.)			Internal	%	3	1.75	3	1.75
Density	1183	T 51063	DIN 53479			1.19		1.19
<b>MECHANICAL PROPERTIES</b>								
Poisson ratio to 20°C						0.39		0.39
Tensile strength to 23°C	527	T 51034	DIN 53455					
Stress at break	-2/1A/5			MPa	4	76	4	74
Modulus of elasticity				MPa	4	3300	4	3300
Elongation at break				%	4	6	4	5
Tensile strength to -20°C	527	T 31034	DIN 53455					
Stress at break	-2/1A/5			MPa	4	102		
Elongation at break				%	4	5		
Tensile strength to 80°C	527	T 51304	DIN 53455					
Stress at break	-2/1A/5			MPa	4	24		
Elongation at break				%	4	22		
Flexural strength to 23°C	178*	T 51001	DIN 53452					
Stress at break				MPa	4	130	4	120
Modulus of elasticity				MPa	4	3250	4	3250
Charpy impact strength (un-notched)	179/2D	T 51035	DIN 53453	Kj/m <sup>2</sup>	4	12	4	10
Izod impact strength (notched)	180/1A		ASTM D256A	Kj/m <sup>2</sup>	4	1.4	4	1.3
Hardness, Rockwell Scale M	2039		ASTM D 785			100		95
Hardness, Shore Scale D	868	T 51109				60-70		80
Compressive strength	684	T 51101	DIN 53454	MPa	4	130	4	110
Shear strength - dynamic modulus			DIN 53445	MPa		1700		1700
<b>OPTICAL PROPERTIES</b>								
Light transmittance	T 51068	DIN 5036						
3 mm thick				%	3	92	3	92
5 mm thick				%	5	92	5	92
8 mm thick				%			8	92
10 mm thick				%	10	92		
Refractive index	T 51064	DIN 53491				1.492		1.492

**NB:** The standards quoted are not always strictly equivalent. We have given the average values of our laboratory tests, as an indicator only. \* speed: 1mm/min

**WARRANTY:** The information given in this literature is based on the findings of our research and experience. It is intended as a general guide to the use of our products and must not be considered as a binding specification. In no way does this information incur the liability of Altuglas International, especially in case of infringement of the rights of a third party.

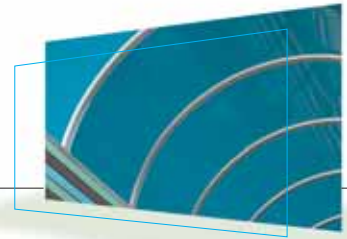

## Main characteristics

## Indicative values

	TEST METHOD			UNITS	ALTUGLAS® CN		ALTUGLAS® EX		
	ISO	NF	Others		Thickness mm	Value	Thickness mm	Value	
<b>ELECTRICAL PROPERTIES</b>									
Dielectric strength		C 26225	DIN 53481	KV/mm		20 to 25		20 to 25	
Transverse resistivity		C 26215	DIN 53482	Ohm.cm		> 10 <sup>15</sup>		> 10 <sup>15</sup>	
Dielectric constant		C 26230	DIN 53483						
to 50 Hz						3.7		3.7	
to 1 MHz						2.6		2.6	
<b>THERMAL PROPERTIES</b>									
Coefficient of linear expansion	EN 2155-1	T 51251	DIN 52328	mm/m/°C		0.065		0.065	
Thermal conductivity			DIN 52612	W/m/°C		0.17		0.19	
Specific heat			ASTM C 351	J/g/°C		1.32		1.32	
Insulation coefficient K			DIN 4701						
3 mm thick				W/m <sup>2</sup> /°C		3	5.4	3	5.4
5 mm thick				W/m <sup>2</sup> /°C		5	5.1	5	5.1
10 mm thick				W/m <sup>2</sup> /°C		10	4.5	10	4.5
Vicat softening point B 10/10, conditioned samples	306	T 51021	DIN 53460	°C		115		105	
Heat distortion temperature under load, 1.8 N/mm <sup>2</sup> , conditioned samples	75/A	T 51005	DIN 53461	°C		109		102	
Max. continuous service temperature				°C		85		80	
Forming oven temperature				°C		130-190		140-175	
Max. heating temperature				°C		200		180	
Max. linear shrinkage after heating, thickness ≥ 3 mm				%		2		3	
Max. linear shrinkage after heating, thickness < 3 mm				%		2		6	
Max. superficial temperature under infrared				°C		220		210	
<b>FLAMMABILITY</b>									
Self-ignition temperature				°C		approx.450		approx.450	
Flame resistance (Radiant heat source)		P 92501			3	M4		M4	
Melt behaviour when burning		P 92505			3	non-drip		drips	
Flame resistance			DIN 4102			B2		B2	
Flame resistance			BS 476 Pt. 7			class 3		class 4	
Flame resistance			UL 94			HB		HB	
Oxygen index		T 5107	ASTM 2863 77	%		18		18	
Chlorine content				%		0		0	
Nitrogen content				%		< 0.02		< 0.02	

**NB:** The standards quoted are not always strictly equivalent. We have given the average values of our laboratory tests, as an indicator only.

**WARRANTY:** The information given in this literature is based on the findings of our research and experience. It is intended as a general guide to the use of our products and must not be considered as a binding specification. In no way does this information incur the liability of Altuglas International, especially in case of infringement of the rights of a third party.

# Properties of Altuglas®

## OPTICAL PROPERTIES

Altuglas® is inherently extremely transparent. Altuglas® CN and Altuglas® EX have a light transmission index of 92 % for a thickness of 3 mm (DIN 5036 standard).

The Altuglas® range includes qualities with specific optical properties. These reduce or increase the transmission of certain wavelengths.

- Altuglas® CN UVD
- Altuglas® CN UV Block
- Altuglas® EX UVX
- Altuglas® CN IR
- Altuglas® CN Inactinic

### SUMMARY TABLE

Designation	Reference	Application	Characteristics TL in % - Wavelength in nanometres
Altuglas® CN UV Block	141 10000	Protection of piece of art in museums	- Filters out UV waves - TL < 1 % from 200 to 370 nm
Altuglas® CN IR	100 18009	Infrared detection systems (remote controls, cameras, etc)	- Filters out visible wavelengths and transmits near-infrared - TL of ± 90 % of UVA (325-380 nm)
Altuglas® CN Inactinic	100 12004 100 15000	Glazed panels for photo labs	- Filters white light to make it harmless to photographic film - TL < 5 % from 250 to 570 nm
Altuglas® CN UVD	123 10000	Sun-beds	- Resistance to ageing under UV lamps - TL of ± 90 % of UVA (325-380 nm)
Altuglas® EX UVX	226 10000	Sun-beds	- Resistance to ageing under UV lamps - TL of ± 90 % of UVA (325-380 nm)

Light Transmission Curve for clear Altuglas® CN.

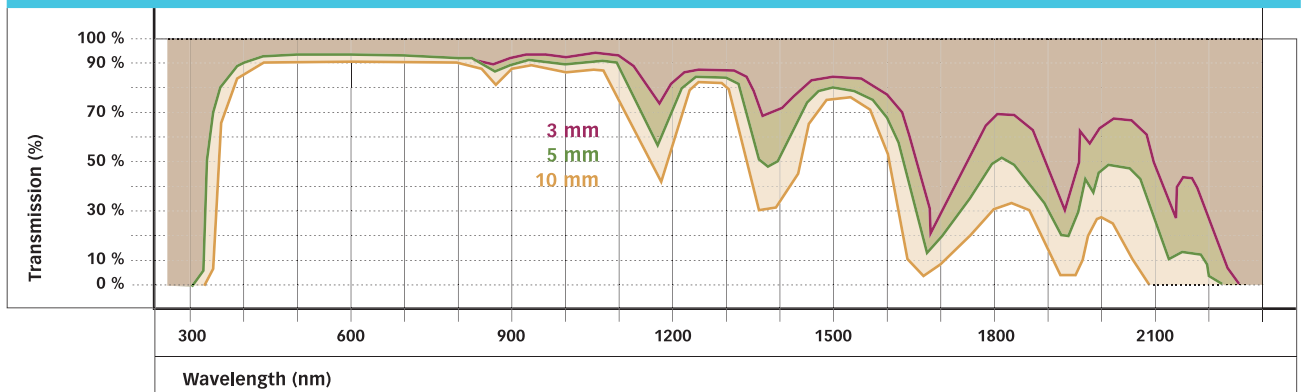

Light Transmission Curve for CN 100 12004 - CN 100 15000 - CN 100 18009.

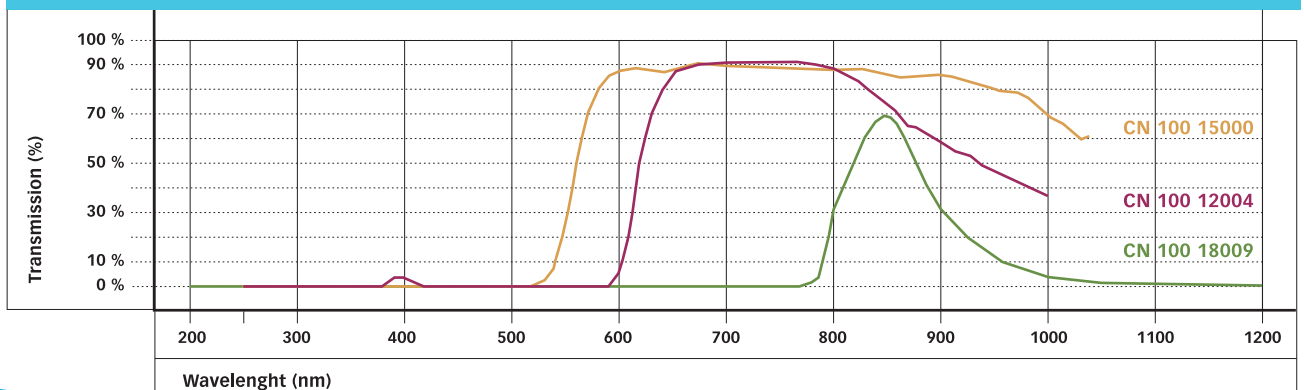

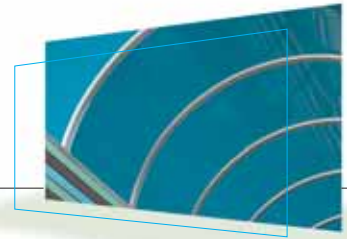

**Ligh transmission, after exposure of Altuglas® CN UVD to UVA radiation.**

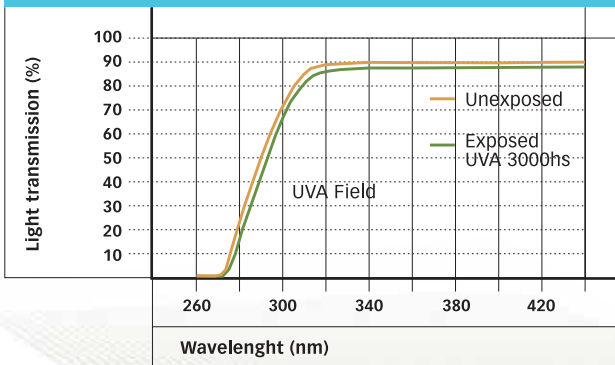

**Ligh transmission, after exposure of Altuglas® EX UVX to UVA radiation.**

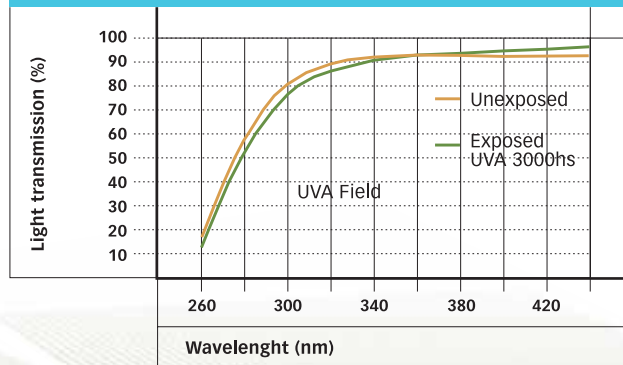

**Acoustic attenuation index Rw as a function of thickness.**

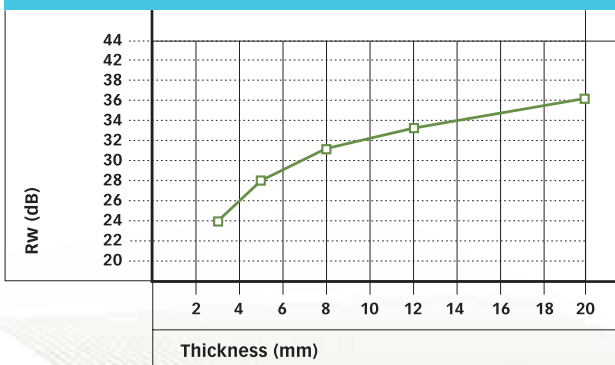

**Variation of elongation at break under traction, as a function of temperature from - 20 to + 80°C.**

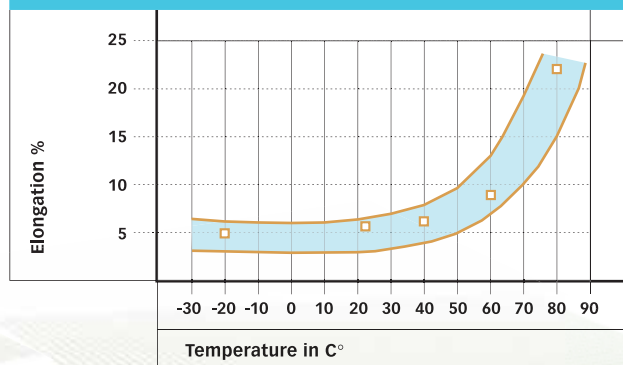

Measurements as specified by the ISO 140 standard and in accordance with C.S.T.B. report No 32 468 dated September 1991.

**Variation in tensile strength, as a function of temperature from - 20 to + 80°C.**

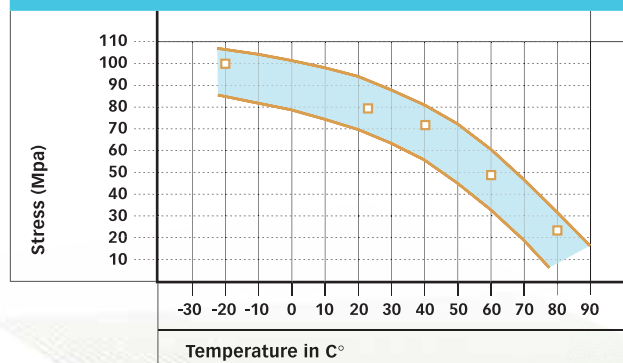

# Properties of Altuglas®

## RESISTANCE TO NATURAL AGEING

The values apply to a Central European climate.

Altuglas® CN and Altuglas® EX have similar physical properties.

Both have the same excellent resistance to natural ageing.

Variation in light transmission as a function of exposure to weathering.

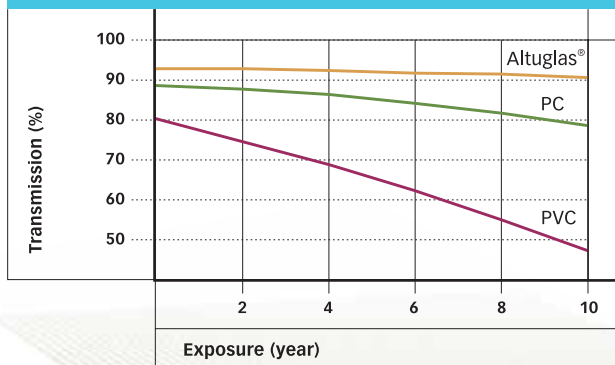

Variation in the yellow index as a function of exposure to weathering.

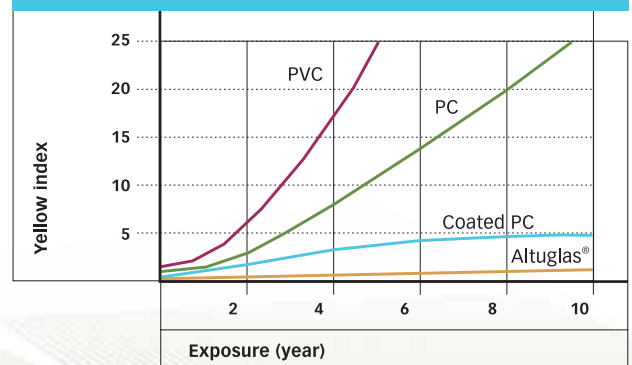

Variation in haze as a function of exposure to weathering.

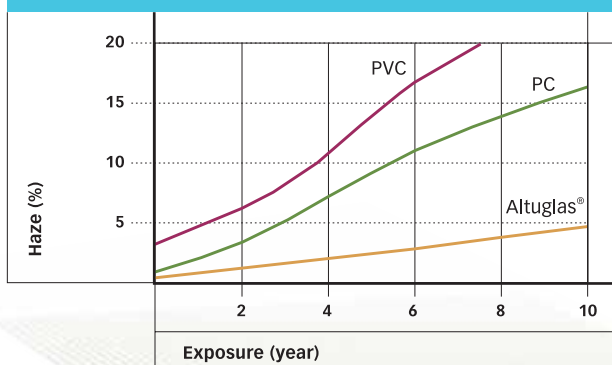





## SIMILARITIES

**Altuglas® CN and Altuglas® EX have similar physical properties.**

**Both have the same excellent resistance to natural ageing.**

The main differences lie in their thermal and chemical properties and some of the ways they are processed.

## DIFFERENCES

**There are intrinsic and behavioural differences between these two materials, with which one must be wholly familiar to obtain high-quality products.**

### Thickness range

Altuglas® CN is available in an almost unlimited range of thicknesses, starting from 2 mm.

Altuglas® EX is available in thicknesses from 1.5 to 25 mm.

### Dimensional variations

The Altuglas® CN manufacturing process leads to slight variations in the thickness of sheets, whereas the thickness of Altuglas® EX sheet varies very little, if at all.

Altuglas® CN has an isotropic response to temperature, with a maximum shrinkage of 2 % in all directions.

The extrusion process applied to Altuglas® EX leads to variable shrinkage, depending on thickness and direction.

#### In the extrusion direction:

- Maximum of 3 % for thicknesses of 3 mm and over.
- Maximum of 6 % for thicknesses under 3 mm.

#### Transversally:

- Maximum of 1% for thicknesses above 3 mm.
- Maximum of 2 % for thicknesses under 3 mm.

### Thermal stability and viscosity

The average molar mass of Altuglas® CN is much higher than Altuglas® EX (3,000,000 compared with 150,000), with much longer molecular chains. This gives it better thermal stability and better resistance to crazing when exposed to solvents. The thermoforming range is also wider. Altuglas® CN can be reworked hot, which is not possible with extruded sheets.

Altuglas® EX has a much lower viscosity when hot, which makes it more ductile than Altuglas® CN. It can therefore be used for more intricate shapes during complex forming.

### Optical properties

Altuglas® CN has unrivalled surface properties and optical purity.

## SAME FIELDS OF APPLICATIONS

### Common applications

Experience has shown that Altuglas® CN and Altuglas® EX can be interchanged freely. The choice of one product rather than the other will be dictated not only by intrinsic differences in their characteristics, but also by the associated conditions, tools and manufacturing costs.

## RECYCLING POSSIBILITIES

### Processing off-cuts

Off-cuts from either cast or extruded sheet can be reprocessed without causing any special environmental problems.

Altuglas® is an easily recyclable material.

Possible recycling methods are:

- **Altuglas® EX** waste can be ground and then re-used.
- **Altuglas® CN** waste can be subjected to a "cracking" process. This allows recovery of the original monomer (methylmethacrylate).

If recycling is impossible, off-cuts can be incinerated.

# Working with Altuglas®

## STORAGE OF SHEETS

### SAFETY

Edges of sheets may be sharp. It is recommended that gloves be worn for protection during handling.

Sheets must be stored in a dry place. It is advisable to place a polyethylene cover over the stack when a sheet is removed, to reduce moisture absorption.

It is recommended that sheets of Altuglas® be stored horizontally on their original delivery pallets, and that the pallets be placed on horizontal storage shelves. It is strongly recommended that pallets should not be stacked, which carries the risk of creating internal tensions and spoiling the flatness of the sheets.

If a vertical storage method is adopted, it is preferable that Altuglas® sheets be leant against solid supports inclined at approximately 80°, to avoid any bending.

It is strongly recommended to avoid storage longer than 6 months.

Flatness of the sheets could be altered if sheets are stored and/or transported in a humid environment.

## PROTECTIVE FILM

### Protective film

Both faces of Altuglas® CN and EX sheets are protected by polyethylene film. The top-face film carries the identification marks. With the exception of certain products for which special information is available (e.g. Altuglas® Silver Star), the top face is to be regarded as the working surface.

It is strongly recommended to avoid external storage. Protective film and adhesives could be damaged by UV emissions, which would make it difficult to remove the masking film.

### Identification marks and traceability

Altuglas® sheets have at least two longitudinal markings, a few centimetres from the two edges. The markings indicate the name of the product, Altuglas® CN or Altuglas® EX, followed by the product code, colour code, thickness in millimetres and batch number.

If cutting is done and for traceability reason, it is recommended to note the batch number.

This marking provides traceability for all our production batches.

### When to remove the film

It is preferable to leave the protective film in position throughout machining, to keep the sheet surface in perfect condition.

Special precautions in respect of thermoforming:

**Altuglas® CN:** The protective film must be removed before heating and thermoforming

**Altuglas® EX:** This precaution is unnecessary for Altuglas® EX, provided the following conditions are observed:

- The film must be totally free from surface faults (holes, scoring, bubbles, etc), which could mark the part.
- The film must not touch the oven trays.

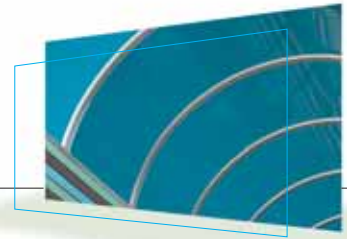

## MACHINING

### SAFETY

The various machining processes that are possible with Altuglas® sheets may result in ejection of large quantities of hard, sharp swarf. It is recommended that goggles be worn during such operations.

In terms of hardness, Altuglas® lies between wood and iron, and is quite close to aluminium or light alloys. It can be machined (cut, milled, turned or drilled) using machine tools for either wood or metal.

### Recommendations for machining

Excessively fast machining causes local overheating, generating internal stresses which must subsequently be relieved by annealing. Otherwise, sooner or later, these stresses will cause fine surface crazing, which may spread under the effects of solvents or stress (for example, during bonding or painting).

The material will not overheat during machining if the following general guidelines are followed:

- Keep tools really sharp.
- Ensure efficient removal of swarf.
- Spray with water containing 2 % of cutting oil ("soluble" oil), or use a small jet of compressed air, or spray atomised water directly at the cutting position.

Altuglas® EX is more sensitive to overheating than Altuglas® CN.

During machining, parts must be clamped properly to avoid any vibration. This recommendation is particularly important when the sheets are thin. Strong vibration may result in unattractive edges and broken corners.

## CUTTING & OTHER MACHINING

When a sheet is being cut, the blade entry and exit stages are the most critical.

Altuglas® CN can be cut with very simple tools such as a hacksaw. However, this is not recommended: it is a long and delicate operation that cannot provide a very good finish. This method of cutting is strongly discouraged for Altuglas® EX.

A number of industrial cutting methods are suitable for Altuglas®.

Circular saws are normally used for straight cuts, with bandsaws or router cutters for other shapes. Other more sophisticated methods such as lasers or water jets give excellent results.

Altuglas® can be machined using numerous other processes such as drilling, turning, milling or sanding.

## THERMOFORMING

Altuglas® is a very versatile, transparent thermoplastic. Parts with very complicated shapes can be created by thermoforming. Products obtained in this way retain all the original properties of the material: transparency, resistance to UV and mechanical strength, special surface aspects (Altuglas® Dual satin, Altuglas® Frosted).

## OTHER PROCESSES

Altuglas® may be bonded. Using Altuglas® P10 and P12 polymerizing adhesives, the strength of the bonded joint can be close to that of the properties of the original material.

The most frequently used methods for decorating Altuglas® are screen-printing, spraying or applying coloured self-adhesive vinyl films.

New lighting technologies such as LEDs (light-emitting diodes) are opening up further possibilities.

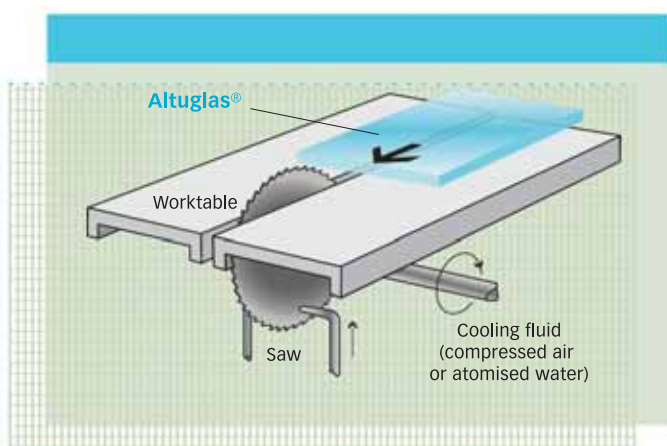

# Working with Altuglas®

## STRAIGHT CUTTING

### Cutting along a groove

#### SAFETY

Each time Altuglas® sheets are worked, it is strongly recommended that gloves, protective glasses and sound protection be worn during operations.

This is not generally recommended, as the edges of the cut are irregular and require subsequent sanding. The technique can only be used for sheets with a thickness of 3 mm or less, over lengths of less than 400 mm.

The groove can be made using a cutter with a sickle-shaped blade. Repeat the grooving several times. Use the edge of a table to break along the groove.

Goggles and gloves must be worn for protection.

### Bandsaw

This type of saw is generally used to cut curves. However, it can also be used for straight cuts on thick sheets.

It never gives a clean edge and lengthy finishing operations are necessary if a polished edge is required.

Woodworking machines with a linear cutting speed of 15 to 25 m/sec can be used.

This type of blade does not allow really clean cutting and requires a large amount of finishing work. It is used mainly for cutting rough shapes prior to forming, or cutting around formed parts prior to finishing.

Any woodworking machinery with a linear speed of between 15 and 25 m/sec may be used.

#### Example of a steel bandsaw with set teeth.

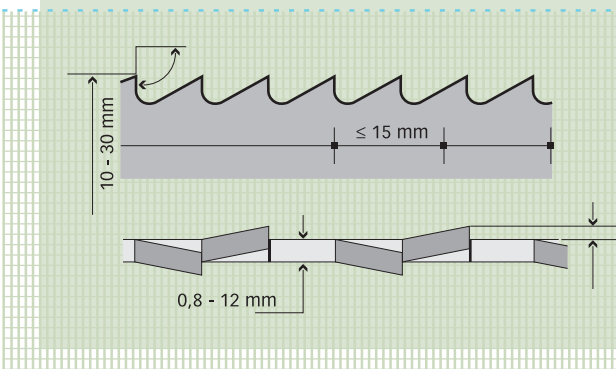

### Jigsaw

This method of cutting has little to recommend it, in view of the low quality of cut achieved.

Settings: medium cutting speed, with no swing. Medium advance speed. The saw must be in motion before cutting starts. Hold the base of the saw firmly against the sheet and minimise vibration of the sheet as far as possible.

#### Carbide-tipped blade with straight or set trapezoidal teeth (tooth pitch: 1cm).

Circumferential speed  $\leq 3\,000$  m/min Feed speed = 4 - 6 m/min

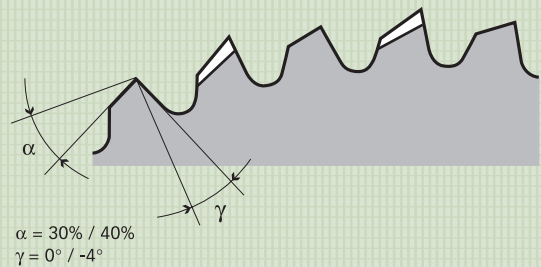

#### HSS or SHSS blade with set teeth.

Circumferential speed  $\leq 3\,000$  m/min Feed speed = 15 - 25 m/s

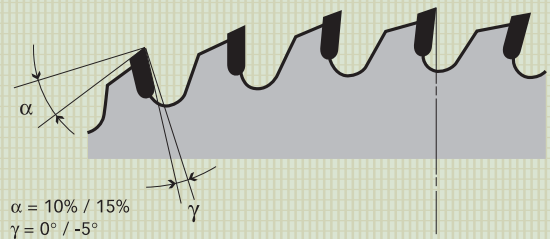

## STRAIGHT CUTTING & CUTTING SHAPES

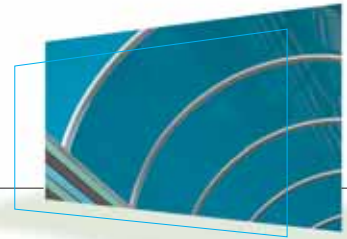

### RECOMMENDED SPEED FOR DIFFERENT SAW DIAMETERS

Saw diameters (mm)	Rotation speed (rpm)
150	6400
200	4800
250	3800
300	3200
350	2800
400	2400

#### Circular saw

Circular saws give a straight, accurate cut. This is the most frequently used technique. When cut, Altuglas® sheets have a clean surface.

#### Two types of blade are usually used:

- Carbide-tipped blades are recommended for industrial use, for cutting piles of sheets.
- High-speed steel blades are usually used to cut single sheets.

The teeth are radial (the cutting edges are aligned with the centre) and are backed-off to form an angle of 45° at the tip.

The teeth are not set but the saw must have a rake of approx. 0.2 % on each face.

Pitch: 2 to 5 teeth per cm, depending on the Altuglas® being cut. Cooling by a jet of compressed air or water is recommended.

#### Milling

Milling can be used to obtain complex shapes with a clean, polished machine finish.

It is advisable to use plain cylindrical milling cutters with two or more cutting edges, preferably one-piece carbide-tipped. High speed or super-high speed steel tools will give indifferent quality results.

The rotation speed must be between 10,000 and 30,000 rpm, depending on the diameter and number of cutting edges used, and compressed air cooling may be helpful.

Milling can be used for several operations such as:

- Cutting through.
- Engraving.
- Finishing edges.

A polished finish can be obtained in a single operation if diamond-tipped tools are used.

Annealing is generally recommended.

#### Laser cutting

This process offers many advantages:

- It allows most shapes to be produced extremely accurately.
- It minimises off-cuts.
- It gives an excellent edge-finish, generally requiring little or no final polishing. Differences in quality of the cut will be seen, depending on the source and power of the laser, the speed of cut, as well as the thickness and pigmentation of the Altuglas®.

Laser cutting causes high internal stresses, which mean there must be no contact with solvents (adhesives, harsh cleaning products, etc). Annealing will reduce the risks of crazing (see page 25). However, it is inadvisable to use adhesives in conjunction with laser cutting.

#### Water-jet cutting

This process offers similar advantages to laser cutting, except for the edges which are not glossy in appearance. An additional advantage is that there are no internal stresses near the cut edge. Contact with solvents is permissible, including adhesives.

# Working with Altuglas®

## OTHER FORMS OF MACHINING

### Drilling machines and bits

Drilling can be carried out with fixed or portable drilling machines, fitted with high speed, super-high speed or carbide-tipped steel drills for light metal, specially ground for Altuglas®.

"Drill File" conical bits may also be used.

It is recommended that the edge of the drill be ground parallel to its centre line, to suit the special characteristics of Altuglas®.

### Method

When drilling deep holes, the bit should be withdrawn frequently to help eject swarf and minimise heating that may damage the material. The use of carbide-tipped drills under lubrication is recommended, to obtain a high-grade finish on the sides of the holes.

#### HSS, SHSS or carbide-tipped drills.

$\alpha = 3^\circ / 8^\circ$   
 $\phi = 60\% / 90\%$

$\gamma = 0^\circ / 4^\circ$   
 $\beta = 12^\circ / 16^\circ$

Circumferential speed  
= 30 - 50 m/min  
Feed speed  
= 0,05 - 0,1 mm/rev

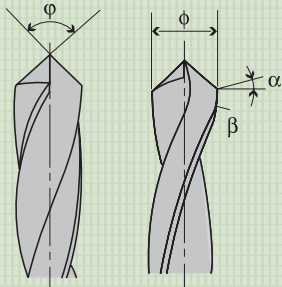

#### "Drill-File" conical bit.

#### Bit rotation speed as a function of hole diameter.

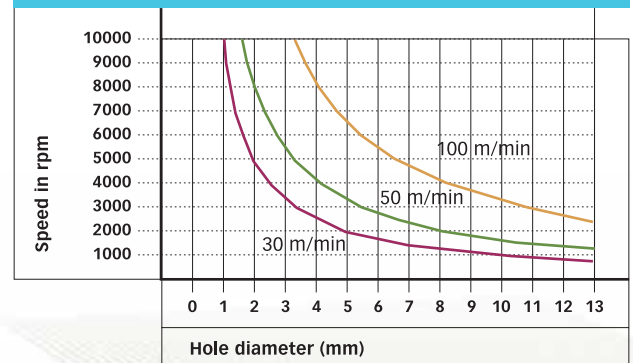

#### A drill specially ground for Altuglas®.

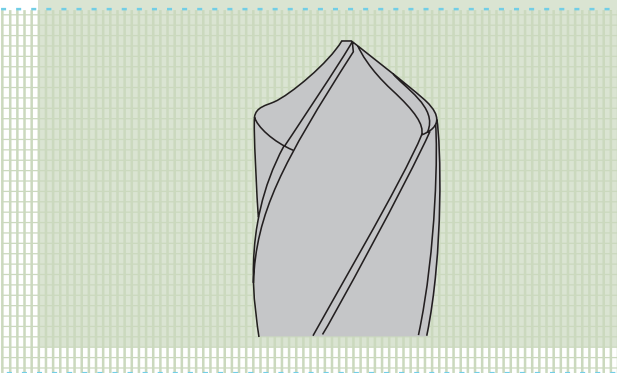

#### Optimum feed speed as a function of bit rotation speed.

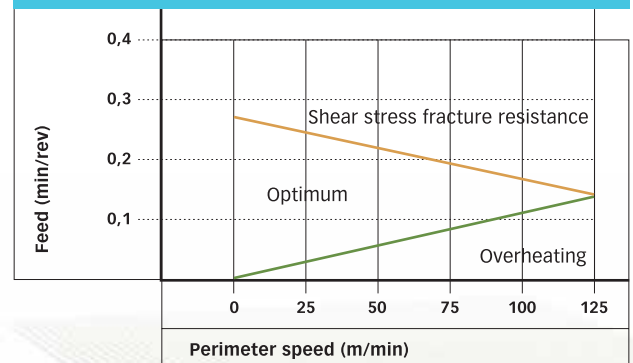

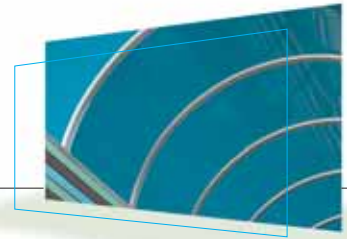

## Turning

Altuglas® can be turned in the same way as light metals, using ordinary tools, at the highest possible rotation speed and a low feed speed. In this case the material must be cooled by means of pure water, or a mixture of water and 2 % cutting oil.

### A drill specially ground for Altuglas®.

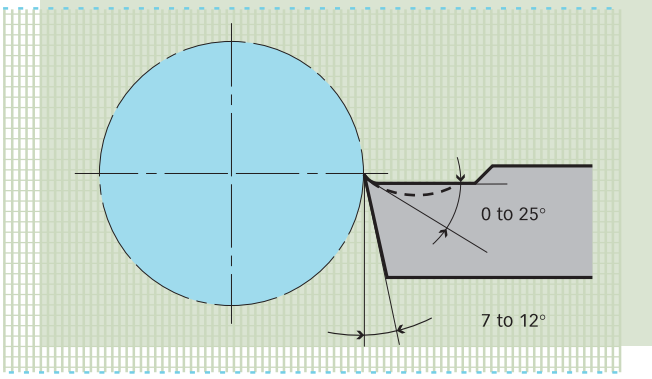

## Engraving

This can be carried out using a variety of processes:

- **Milling:** engraving by milling is generally carried out on digitally controlled machine-tools
- **Laser:** it is possible to engrave within a sheet, in 3 dimensions

## Sanding

Sanding is required to finish the edges of coarsely cut sheet. Wet carborundum paper is used, either by hand or on a disc or belt sanding machine. For the latter, the recommended belt speed is 10 m/s. A water spray should preferably be applied during sanding, to minimise overheating of the material.

### It is preferable to proceed in stages, using in turn:

- A coarse-grain abrasive paper (e.g. 60).
- A medium-grain abrasive paper (e.g. 220).
- A fine-grain abrasive paper (e.g. 500).

Sanding can be a very similar process to polishing, when the abrasives used are extremely fine.

The Micro-mesh® Polishing Kit restores the transparency of Altuglas® sheets whose surface has been damaged by shallow scratching.

It is preferable to use underwater sanding (simultaneous lubrication and cooling). The successive use of grain sizes 1500, 2400, 4000, 8000 and 12000 allows an almost perfect surface finish to be obtained. A final polishing operation with Altuglas® Polish 1 and 2 allows the original surface polish to be fully restored. For further information, see the instructions provided with the kit.

# Working with Altuglas®

## OTHER FORMS OF MACHINING

### ABRASIVE POLISHING

After sanding, the material may be polished to restore its original surface gloss. This can be carried out by hand or using mechanical processes.

#### Machine polishing

Some edge-milling machines use diamond tools and give a polished finish directly. Edges can also be polished with a felt-belt polisher or a disc polisher, fitted with cotton or flannel buffs, using a polishing paste that is compatible with Altuglas®. Flat surfaces are polished using portable disc polishers, fitted with felt or sheepskin buffs soaked in Altuglas® Polish.

#### Hand polishing

This carried out using non-woven suede cloth or felt, together with a polishing agent. Use Altuglas® Polish N° 1, alone or with N° 2, depending on the degree of polish required. It may be necessary to precede this with use of the Micro-mesh® Kit, as described in the section on sanding on the previous page.

After polishing, Altuglas® Cleaner can be used to remove any finger or handling marks. This improves the gloss and reduces static somewhat, which slows down the accumulation of dust and reduces the frequency of cleaning.

### FLAME POLISHING

Using this technique, the machined edges of Altuglas® CN are exposed to a high-temperature flame over a restricted area. Passing the flame quickly over the area to be treated melts it, but does not burn it. As it cools, the melted material forms a perfectly smooth surface. If the machining has been carried out with tools that leave clean edges, the flame allows a polished, glossy surface to be obtained. Otherwise, the edge must first be sanded.

Flame polishing is a very fast technique, but requires certain precautions.

The surfaces being polished must be completely clean and free of any contamination. In particular, avoid touching the surface with fingers.

The technique is for use only with clear or transparent coloured parts. A test must be carried out before using it on diffusing or coloured sheets.

An oxyacetylene torch is often used, with a flame temperature between 2,700 and 2,900°C. The flame must be adjusted to contain excess oxygen (an oxidizing flame).

Lastly, this method causes very high stresses in the material, which must be relieved by annealing before painting, screen-printing or bonding.

#### Flame polishing with an oxyacetylene torch.

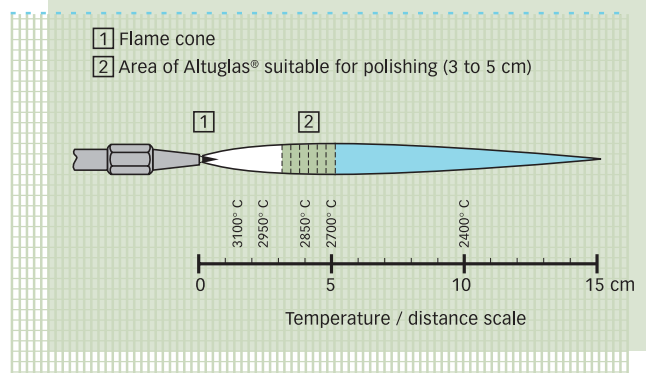



## THERMOFORMING

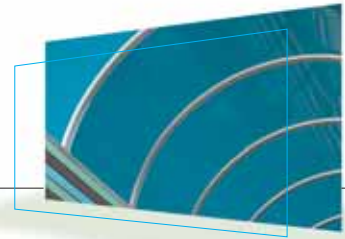

### SAFETY

In some of the forming processes described below, hot sheet is stretched by vacuum or air pressure, with one face still exposed to the atmosphere. Although highly unlikely, the sudden failure of a sheet during forming could be dangerous for staff nearby. Guards must be provided to prevent the ejection of particles, which could be quite sharp.

### PRELIMINARY INFORMATION

Thermoforming involves three steps: heating, forming and cooling.

An initial stoving (pre-heating) stage may be necessary, to eliminate moisture from the sheet.

When heated to a suitable temperature (depending on the specific type), Altuglas® becomes soft and rubbery. It can then be given a wide variety of shapes using suitable moulds. Cooling then restores its initial rigidity, while retaining the given shape.

#### Differences between Altuglas® CN and Altuglas® EX

If a piece of Altuglas® CN does not take up exactly the required shape, it can be reheated and corrected or reused. This can only be done with Altuglas® EX if it has not been stretched.

#### Thermoforming and protective film

For **Altuglas® CN**: it is essential to remove the protective film before heating and thermoforming.

For **Altuglas® EX**: this precaution is unnecessary, provided the following precautions are observed:

- The film must be totally free from surface faults (pinholes, scratches or bubbles, etc), which could result in marks on the part.
- The film must not touch the oven trays.

### STOVING (PRE-HEATING)

The stoving stage removes internal moisture from the sheets. The sheets are placed in a ventilated oven, at a temperature between 75° and 80°C, for a period of 1 to 2 hours per mm thickness.

The sheets should preferably be separated from one another, in order to facilitate circulation of hot air and rapid evacuation of moisture from the sheets.

### HEATING EQUIPMENT

After stoving (if necessary), sheets may be heated using one of 2 industrial processes:

#### Circulating hot-air oven

This is the only acceptable heating method for parts requiring good optical properties. The temperature can be accurately controlled and Altuglas® CN sheets can be kept hot while awaiting thermoforming. Altuglas® EX sheets require a shorter heating time and oven waiting time must be kept to a minimum. Altuglas® EX also cools faster than Altuglas® CN.

#### Infrared heating

This method of heating has low thermal inertia and warm-up time is therefore short.

- When used for thermoforming, it offers high productivity, automated operation and low labour costs. However, the investment is high.

- When used only for stoving (pre-heating), the cost is low but temperature control is more difficult and heating must be done in two stages for thicknesses  $\geq 5$  mm.