



V-BELT PULLEYS

V-BELT PULLEYS FOR TAPER BUSHES

| | |
|------------|--------|
| SPZ | page 5 |
| SPA | 9 |
| SPB | 13 |
| SPC | 18 |

V-BELT PULLEYS PILOT BORE

| | |
|------------|----|
| SPA | 23 |
| SPB | 25 |
| SPC | 28 |

V-BELT PULLEYS FOR LOCKING DEVICES

| | |
|------------|----|
| SPA | 30 |
| SPB | 31 |
| SPC | 33 |

ADJUSTABLE V-BELT PULLEY PRB TYPE 34

| | |
|-------------------------------------|----|
| V-BELT PULLEYS PPV-J MICRO V | 39 |
|-------------------------------------|----|

| | |
|-------------------------------------|----|
| V-BELT PULLEYS PPV-L MICRO V | 40 |
|-------------------------------------|----|



CAST- IRON V-BELT PULLEYS





CAST- IRON V-BELT PULLEYS

All V-belt pulleys are compliant with current legislation and are made of cast iron **GG 20** with protective phosphate.

Running in normal standard, the pulleys are statically balanced and this is sufficient for peripheral speeds up to **25 m/s**.

For higher speeds is essential dynamic balancing can be provided on request.

The Chiaravalli Group SpA is able to perform, upon request, balancing pulleys with diameters up to 630, with balancing CNC, accompanying certificate of balancing performed.

Over 35 m / sec, the pulleys in cast iron are not the most suitable and it requires the use of high-strength material.

D = diameter in meters

N = number of revolutions per minute

$$V_p = \frac{\pi \cdot D \cdot n}{60} = \frac{D \cdot n}{19,1} \text{ m/sec.}$$

Dimensions shown on the dimensional tables are not binding even if they are respected as far as possible.

We reserve the right to make variations and modifications without prior notice.

FEATURES OF THE GORGE

| PROFILE | Dp mm | α° | W pg | g | h | b mm | f | e |
|------------|----------|-----|------|------|----|---------|------|------|
| SPZ | < 80 | 34° | 8,5 | 9,7 | 9 | 2 | 8 | 12 |
| | > 80 | 38° | | | | | | |
| SPA | < 118 | 34° | 11 | 12,7 | 11 | 2,8 | 10 | 15 |
| | > 118 | 38° | | | | | | |
| SPB | < 190 | 34° | 14 | 16,3 | 14 | 3,5 | 12,5 | 19 |
| | > 190 | 38° | | | | | | |
| SPC | < 315 | 34° | 19 | 22,0 | 19 | 4,8 | 17 | 25,5 |
| | > 315 | 38° | | | | | | |

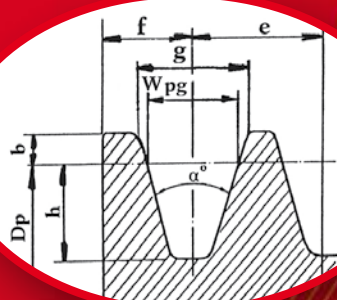

BAND WIDTH

| N° GROOVES | SPZ | SPA | SPB | SPC |
|------------|-----|-----|-----|------|
| 1 | 16 | 20 | 25 | 34 |
| 2 | 28 | 35 | 44 | 59,5 |
| 3 | 40 | 50 | 63 | 85 |
| 4 | 52 | 65 | 82 | 111 |
| 5 | 64 | 80 | 101 | 136 |
| 6 | | 95 | 120 | 162 |
| 8 | | | 158 | 213 |
| 10 | | | 196 | 264 |

V-BELT PULLEYS for TAPER BUSHES



V-BELT PULLEYS for TAPER BUSHES

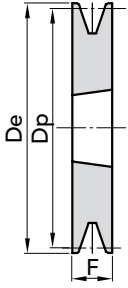

EXEC. 1

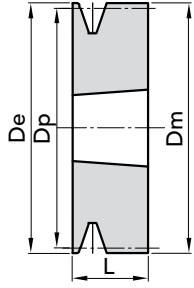

EXEC. 2

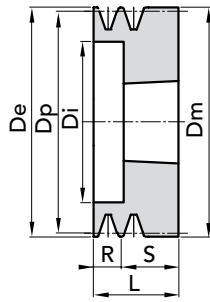

EXEC. 3

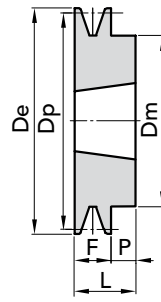

EXEC. 4

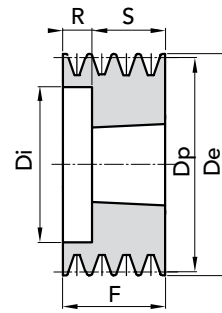

EXEC. 5

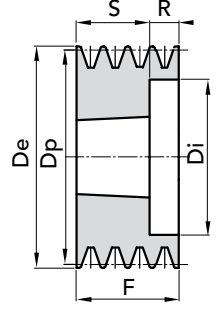

EXEC. 6

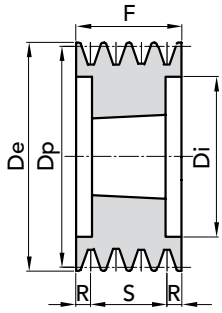

EXEC. 7

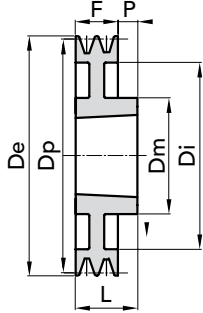

EXEC. 8

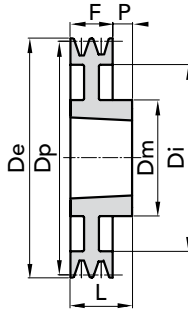

EXEC. 8A

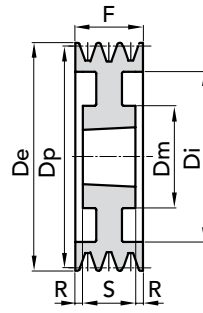

EXEC. 9

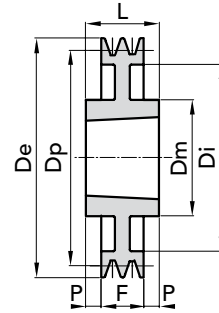

EXEC. 10

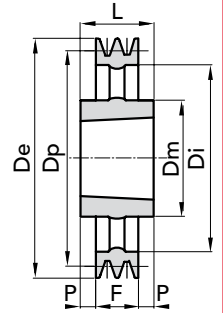

EXEC. 11

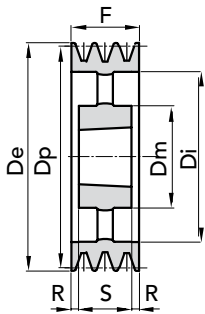

EXEC. 12

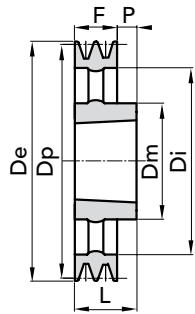

EXEC. 13

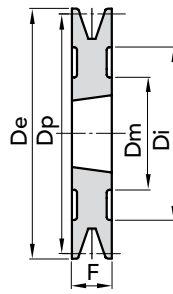

EXEC. 14

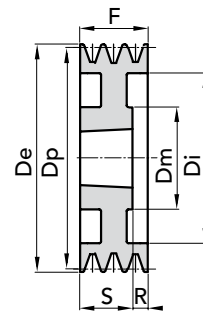

EXEC. 15

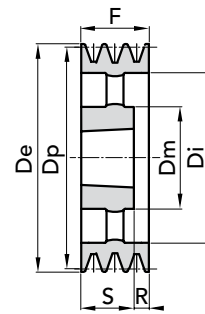

EXEC. 16

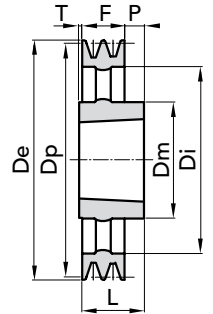

EXEC. 17



V-BELT PULLEYS for TAPER BUSHES

5

TAPER BUSHES

SPZ TYPE

We are engaged to respect shapes and dimensions shown on this sheet but, we reserve the right to make changes and modifications without notice.

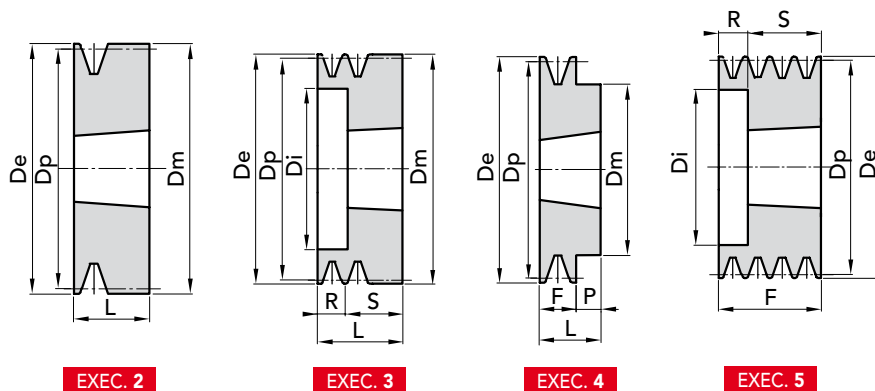

EXEC. 2

EXEC. 3

EXEC. 4

EXEC. 5

| Dp | P. NUMBER | N° | EXEC. | BUSHE | Ø De | Ø Di | Ø Dm | F | L | P | R | S | WEIGHT |
|---------|-----------|----|-------|-------|-------|------|------|----|----|---|----|----|--------|
| GROOVES | | | | | | | | | | | | | |
| Kg. | | | | | | | | | | | | | |
| 60 | 91100601 | 1 | 2 | 1108 | 64,6 | | 64,6 | | 22 | | | | 0,50 |
| | 91100602 | 2 | 3 | 1108 | 64,6 | 36 | 64,6 | | 49 | | 27 | 22 | 0,60 |
| 63 | 91100631 | 1 | 4 | 1108 | 67,6 | | 62 | 16 | 22 | 6 | | | 0,40 |
| | 91100632 | 2 | 5 | 1108 | 67,6 | 40 | | 28 | | | 6 | 22 | 0,50 |
| | 91100633 | 3 | 5 | 1108 | 67,6 | 40 | | 40 | | | 18 | 22 | 0,50 |
| 67 | 91100671 | 1 | 4 | 1108 | 71,6 | | 62 | 16 | 22 | 6 | | | 0,50 |
| | 91100672 | 2 | 5 | 1108 | 71,6 | 42 | | 28 | | | 6 | 22 | 0,50 |
| | 91100673 | 3 | 5 | 1108 | 71,6 | 42 | | 40 | | | 18 | 22 | 0,70 |
| 71 | 91100711 | 1 | 4 | 1108 | 75,6 | | 62 | 16 | 22 | 6 | | | 0,50 |
| | 91100712 | 2 | 5 | 1108 | 75,6 | 42 | | 28 | | | 6 | 22 | 0,50 |
| | 91100713 | 3 | 5 | 1108 | 75,6 | 42 | | 40 | | | 18 | 22 | 0,70 |
| 75 | 91100751 | 1 | 4 | 1108 | 79,6 | | 62 | 16 | 22 | 6 | | | 0,60 |
| | 91100752 | 2 | 5 | 1210 | 79,6 | 51 | | 28 | | | 3 | 25 | 0,60 |
| | 91100753 | 3 | 5 | 1210 | 79,6 | 48 | | 40 | | | 15 | 25 | 0,80 |
| 80 | 91100801 | 1 | 4 | 1210 | 84,6 | | 75 | 16 | 25 | 9 | | | 0,60 |
| | 91100802 | 2 | 5 | 1210 | 84,6 | 51 | | 28 | | | 3 | 25 | 0,70 |
| | 91100803 | 3 | 5 | 1210 | 84,6 | 51 | | 40 | | | 15 | 25 | 0,80 |
| | 91100804 | 4 | 5 | 1210 | 84,6 | 51 | | 52 | | | 27 | 25 | 0,90 |
| 85 | 91100851 | 1 | 4 | 1210 | 89,6 | | 75 | 16 | 25 | 9 | | | 0,80 |
| | 91100852 | 2 | 5 | 1610 | 89,6 | 60 | | 28 | | | 3 | 25 | 0,70 |
| | 91100853 | 3 | 5 | 1610 | 89,6 | 60 | | 40 | | | 15 | 25 | 0,80 |
| | 91100854 | 4 | 5 | 1610 | 89,6 | 60 | | 42 | | | 27 | 25 | 1,00 |
| | 91100855 | 5 | 5 | 1610 | 89,6 | 60 | | 64 | | | 39 | 25 | 1,30 |
| 90 | 91100901 | 1 | 4 | 1210 | 94,6 | | 75 | 16 | 25 | 9 | | | 0,80 |
| | 91100902 | 2 | 5 | 1610 | 94,6 | 61 | | 28 | | | 3 | 25 | 0,80 |
| | 91100903 | 3 | 5 | 1610 | 94,6 | 61 | | 40 | | | 15 | 25 | 0,90 |
| | 91100904 | 4 | 5 | 1610 | 94,6 | 61 | | 42 | | | 27 | 25 | 1,10 |
| | 91100905 | 5 | 5 | 1610 | 94,6 | 61 | | 64 | | | 39 | 25 | 1,40 |
| 95 | 91100951 | 1 | 4 | 1210 | 99,6 | | 75 | 16 | 25 | 9 | | | 0,90 |
| | 91100952 | 2 | 5 | 1610 | 99,6 | 66 | | 28 | | | 3 | 25 | 0,80 |
| | 91100953 | 3 | 5 | 1610 | 99,6 | 66 | | 40 | | | 15 | 25 | 1,10 |
| | 91100954 | 4 | 5 | 1610 | 99,6 | 66 | | 52 | | | 27 | 25 | 1,30 |
| | 91100955 | 5 | 5 | 1610 | 99,6 | 66 | | 64 | | | 39 | 25 | 1,50 |
| 100 | 91101001 | 1 | 4 | 1210 | 104,6 | | 75 | 16 | 25 | 9 | | | 0,90 |
| | 91101002 | 2 | 5 | 1610 | 104,6 | 71 | | 28 | | | 3 | 25 | 1,20 |
| | 91101003 | 3 | 5 | 1610 | 104,6 | 71 | | 40 | | | 15 | 25 | 1,20 |
| | 91101004 | 4 | 5 | 1610 | 104,6 | 72 | | 52 | | | 27 | 25 | 1,40 |
| | 91101005 | 5 | 5 | 2012 | 104,6 | 72 | | 64 | | | 32 | 32 | 1,60 |
| 106 | 91101061 | 1 | 4 | 1610 | 110,6 | | 80 | 16 | 25 | 9 | | | 1,00 |
| | 91101062 | 2 | 5 | 1610 | 110,6 | 76 | | 28 | | | 3 | 25 | 1,20 |
| | 91101063 | 3 | 5 | 1610 | 110,6 | 78 | | 40 | | | 15 | 25 | 1,40 |
| | 91101064 | 4 | 5 | 1610 | 110,6 | 80 | | 52 | | | 27 | 25 | 1,60 |
| | 91101065 | 5 | 5 | 2012 | 110,6 | 78 | | 64 | | | 32 | 32 | 1,80 |

MATERIAL **CAST-IRON**

CAD drawings available on our site
www.chiaravalli.com

Quantity, availability and prices
 on B2B Chiaravalli

www.bibiscom.ro



V-BELT PULLEYS for TAPER BUSHES

TAPER BUSHES

SPZ TYPE

We are engaged to respect shapes and dimensions shown on this sheet but, we reserve the right to make changes and modifications without notice.

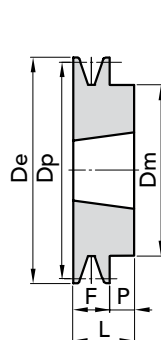

EXEC. 4

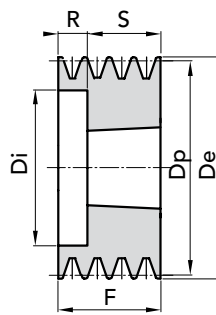

EXEC. 5

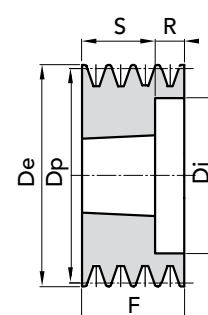

EXEC. 6

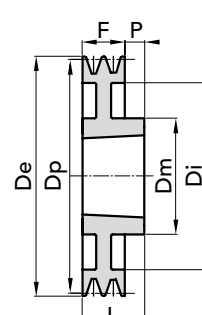

EXEC. 8

| Dp | P. NUMBER | N° | EXEC. | BUSHE | Ø De | Ø Di | Ø Dm | F | L | P | R | S | WEIGHT |
|---------|-----------|----|-------|-------|-------|------|------|----|----|---|----|----|--------|
| GROOVES | | | | | | | | | | | | | |
| Kg. | | | | | | | | | | | | | |
| 112 | 91101121 | 1 | 4 | 1610 | 116,6 | | 80 | 16 | 25 | 9 | | | 1,10 |
| | 91101122 | 2 | 5 | 1610 | 116,6 | 84 | | 28 | | | 3 | 25 | 1,30 |
| | 91101123 | 3 | 5 | 2012 | 116,6 | 84 | | 40 | | | 8 | 32 | 1,50 |
| | 91101124 | 4 | 5 | 2012 | 116,6 | 86 | | 52 | | | 20 | 32 | 1,60 |
| | 91101125 | 5 | 5 | 2012 | 116,6 | 84 | | 64 | | | 32 | 32 | 1,90 |
| 118 | 91101181 | 1 | 4 | 1610 | 122,6 | | 80 | 16 | 25 | 9 | | | 1,30 |
| | 91101182 | 2 | 5 | 1610 | 122,6 | 90 | | 28 | | | 3 | 25 | 1,40 |
| | 91101183 | 3 | 5 | 2012 | 122,6 | 92 | | 40 | | | 8 | 32 | 1,60 |
| | 91101184 | 4 | 5 | 2012 | 122,6 | 92 | | 52 | | | 20 | 32 | 1,90 |
| | 91101185 | 5 | 5 | 2012 | 122,6 | 90 | | 64 | | | 32 | 32 | 2,40 |
| 125 | 91101251 | 1 | 4 | 1610 | 129,6 | | 80 | 16 | 25 | 9 | | | 1,40 |
| | 91101252 | 2 | 5 | 1610 | 129,6 | 97 | | 28 | | | 3 | 25 | 1,70 |
| | 91101253 | 3 | 6 | 2012 | 129,6 | 97 | | 40 | | | 8 | 32 | 2,00 |
| | 91101254 | 4 | 6 | 2012 | 129,6 | 99 | | 52 | | | 20 | 32 | 2,20 |
| | 91101255 | 5 | 5 | 2012 | 129,6 | 97 | | 64 | | | 32 | 32 | 2,80 |
| 132 | 91101321 | 1 | 4 | 1610 | 136,6 | | 80 | 16 | 25 | 9 | | | 1,50 |
| | 91101322 | 2 | 5 | 1610 | 136,6 | 104 | | 28 | | | 3 | 25 | 2,00 |
| | 91101323 | 3 | 6 | 2012 | 136,6 | 104 | | 40 | | | 8 | 32 | 2,40 |
| | 91101324 | 4 | 6 | 2012 | 136,6 | 104 | | 52 | | | 20 | 32 | 2,60 |
| | 91101325 | 5 | 5 | 2517 | 136,6 | 104 | | 64 | | | 19 | 45 | 2,80 |
| 140 | 91101401 | 1 | 4 | 1610 | 144,6 | | 80 | 16 | 25 | 9 | | | 1,50 |
| | 91101402 | 2 | 5 | 1610 | 144,6 | 112 | | 28 | | | 3 | 25 | 2,20 |
| | 91101403 | 3 | 6 | 2012 | 144,6 | 112 | | 40 | | | 8 | 32 | 2,80 |
| | 91101404 | 4 | 6 | 2012 | 144,6 | 112 | | 52 | | | 20 | 32 | 3,00 |
| | 91101405 | 5 | 6 | 2517 | 144,6 | 112 | | 64 | | | 19 | 45 | 3,20 |
| 150 | 91101501 | 1 | 4 | 1610 | 154,6 | | 80 | 16 | 25 | 9 | | | 1,60 |
| | 91101502 | 2 | 4 | 2012 | 154,6 | | 100 | 28 | 32 | 4 | | | 2,30 |
| | 91101503 | 3 | 6 | 2012 | 154,6 | 122 | | 40 | | | 8 | 32 | 3,40 |
| | 91101504 | 4 | 6 | 2517 | 154,6 | 122 | | 52 | | | 7 | 45 | 3,60 |
| | 91101505 | 5 | 6 | 2517 | 154,6 | 122 | | 64 | | | 19 | 45 | 3,90 |
| 160 | 91101601 | 1 | 4 | 1610 | 164,6 | | 80 | 16 | 25 | 9 | | | 1,70 |
| | 91101602 | 2 | 4 | 2012 | 164,6 | | 100 | 28 | 32 | 4 | | | 3,10 |
| | 91101603 | 3 | 6 | 2012 | 164,6 | 132 | | 40 | | | 8 | 32 | 3,60 |
| | 91101604 | 4 | 6 | 2517 | 164,6 | 132 | | 52 | | | 7 | 45 | 4,50 |
| | 91101605 | 5 | 6 | 2517 | 164,6 | 132 | | 64 | | | 19 | 45 | 4,70 |
| 180 | 91101801 | 1 | 4 | 1610 | 184,6 | | 80 | 16 | 25 | 9 | | | 2,00 |
| | 91101802 | 2 | 8 | 2012 | 184,6 | 152 | 100 | 28 | 32 | 4 | | | 2,90 |
| | 91101803 | 3 | 6 | 2012 | 184,6 | 152 | | 40 | | | 8 | 32 | 3,70 |
| | 91101804 | 4 | 6 | 2517 | 184,6 | 152 | | 52 | | | 7 | 45 | 6,30 |
| | 91101805 | 5 | 6 | 2517 | 184,6 | 152 | | 64 | | | 19 | 45 | 6,80 |

MATERIAL **CAST-IRON**

CAD drawings available on our site
www.chiaravalli.com

Quantity, availability and prices
 on B2B Chiaravalli

www.bibiscom.ro



V-BELT PULLEYS for TAPER BUSHES

7

TAPER BUSHES

SECTION **SPZ**

We are engaged to respect shapes and dimensions shown on this sheet but, we reserve the right to make changes and modifications without notice.

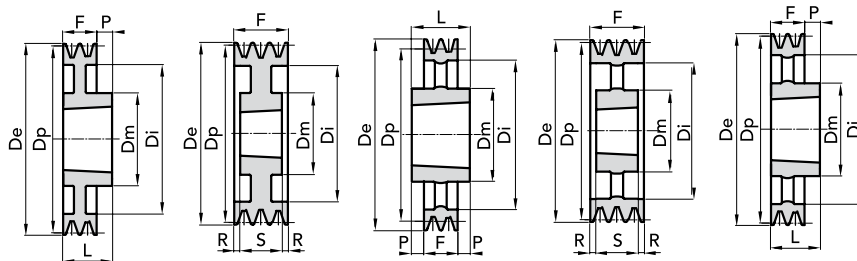

ESEC. 8

ESEC. 9

ESEC. 11

ESEC. 12

ESEC. 13

| Dp | P. NUMBER | N° | EXEC. | BUSHE | Ø De | Ø Di | Ø Dm | F | L | P | R | S | WEIGHT |
|---------|-----------|----|-------|-------|-------|------|------|----|----|------|-----|----|--------|
| GROOVES | | | | | | | | | | | | | Kg. |
| 190 | 91101902 | 2 | 8 | 2012 | 194,6 | 160 | 100 | 28 | 32 | 4 | | | 3,10 |
| | 91101903 | 3 | 9 | 2012 | 194,6 | 160 | 105 | 40 | | | 4 | 32 | 3,40 |
| | 91101904 | 4 | 9 | 2517 | 194,6 | 160 | 120 | 52 | | | 3,5 | 45 | 5,30 |
| 200 | 91102001 | 1 | 8 | 2012 | 204,6 | 172 | 100 | 16 | 32 | 16 | | | 3,40 |
| | 91102002 | 2 | 8 | 2012 | 204,6 | 172 | 100 | 28 | 32 | 4 | | | 3,50 |
| | 91102003 | 3 | 9 | 2012 | 204,6 | 172 | 100 | 40 | | | 4 | 32 | 4,30 |
| | 91102004 | 4 | 9 | 2517 | 204,6 | 172 | 120 | 52 | | | 3,5 | 45 | 5,40 |
| | 91102005 | 5 | 9 | 2517 | 204,6 | 172 | 120 | 64 | | | 9,5 | 45 | 8,80 |
| 224 | 91102241 | 1 | 8 | 2012 | 228,6 | 196 | 100 | 16 | 32 | 16 | | | 3,60 |
| | 91102242 | 2 | 8 | 2012 | 228,6 | 196 | 100 | 28 | 32 | 4 | | | 4,50 |
| | 91102243 | 3 | 9 | 2012 | 228,6 | 196 | 100 | 40 | | | 4 | 32 | 5,40 |
| | 91102244 | 4 | 9 | 2517 | 228,6 | 196 | 120 | 52 | | | 3,5 | 45 | 7,00 |
| | 91102245 | 5 | 9 | 2517 | 228,6 | 196 | 120 | 64 | | | 9,5 | 45 | 8,80 |
| 250 | 91102501 | 1 | 11 | 2012 | 254,6 | 222 | 100 | 16 | 32 | 8 | | | 4,60 |
| | 91102502 | 2 | 11 | 2012 | 254,6 | 222 | 100 | 28 | 32 | 2 | | | 5,40 |
| | 91102503 | 3 | 12 | 2012 | 254,6 | 222 | 100 | 40 | | | 4 | 32 | 6,40 |
| | 91102504 | 4 | 12 | 2517 | 254,6 | 222 | 120 | 52 | | | 3,5 | 45 | 8,00 |
| | 91102505 | 5 | 12 | 2517 | 254,6 | 222 | 120 | 64 | | | 9,5 | 45 | 9,00 |
| 280 | 91102801 | 1 | 11 | 2012 | 284,6 | 252 | 100 | 16 | 32 | 8 | | | 5,50 |
| | 91102802 | 2 | 11 | 2012 | 284,6 | 252 | 100 | 28 | 32 | 2 | | | 6,20 |
| | 91102803 | 3 | 11 | 2517 | 284,6 | 252 | 120 | 40 | 45 | 2,5 | | | 8,30 |
| | 91102804 | 4 | 12 | 2517 | 284,6 | 252 | 120 | 52 | | | 3,5 | 45 | 9,50 |
| | 91102805 | 5 | 12 | 2517 | 284,6 | 252 | 120 | 64 | | | 9,5 | 45 | 11,00 |
| 315 | 91103151 | 1 | 11 | 2012 | 319,6 | 287 | 100 | 16 | 32 | 8 | | | 6,70 |
| | 91103152 | 2 | 11 | 2012 | 319,6 | 287 | 100 | 28 | 32 | 2 | | | 7,20 |
| | 91103153 | 3 | 11 | 2517 | 319,6 | 287 | 120 | 40 | 45 | 2,5 | | | 10,10 |
| | 91103154 | 4 | 12 | 2517 | 319,6 | 287 | 120 | 52 | | | 3,5 | 45 | 12,10 |
| | 91103155 | 5 | 12 | 2517 | 319,6 | 287 | 120 | 64 | | | 9,5 | 45 | 13,30 |
| 355 | 91103551 | 1 | 11 | 2012 | 359,6 | 326 | 100 | 16 | 32 | 8 | | | 6,80 |
| | 91103552 | 2 | 11 | 2012 | 359,6 | 326 | 100 | 28 | 32 | 2 | | | 8,60 |
| | 91103553 | 3 | 11 | 2517 | 359,6 | 326 | 120 | 40 | 45 | 2,5 | | | 11,70 |
| | 91103554 | 4 | 12 | 2517 | 359,6 | 326 | 120 | 52 | | | 3,5 | 45 | 12,80 |
| | 91103555 | 5 | 12 | 2517 | 359,6 | 326 | 120 | 64 | | | 9,5 | 45 | 13,00 |
| 400 | 91104001 | 1 | 11 | 2012 | 404,6 | 371 | 112 | 16 | 32 | 8 | | | 6,90 |
| | 91104002 | 2 | 11 | 2517 | 404,6 | 371 | 125 | 28 | 45 | 8,5 | | | 9,90 |
| | 91104003 | 3 | 11 | 2517 | 404,6 | 371 | 125 | 40 | 45 | 2,5 | | | 13,30 |
| | 91104004 | 4 | 12 | 2517 | 404,6 | 371 | 125 | 52 | 45 | | 3,5 | | 13,60 |
| | 91104005 | 5 | 12 | 3020 | 404,6 | 371 | 158 | 64 | 51 | | 6,5 | | 15,60 |
| 450 | 91104501 | 1 | 11 | 2517 | 454,6 | 421 | 125 | 16 | 45 | 14,5 | | | 7,20 |
| | 91104502 | 2 | 11 | 2517 | 454,6 | 421 | 125 | 28 | 45 | 8,5 | | | 11,20 |
| | 91104503 | 3 | 11 | 2517 | 454,6 | 421 | 125 | 40 | 45 | 2,5 | | | 14,60 |
| | 91104504 | 4 | 12 | 3020 | 454,6 | 421 | 158 | 52 | 51 | | 0,5 | | 14,50 |
| | 91104505 | 5 | 12 | 3020 | 454,6 | 421 | 158 | 64 | 51 | | 8,5 | | 19,00 |
| 500 | 91105002 | 2 | 11 | 2517 | 504,6 | 471 | 125 | 28 | 45 | 8,5 | | | 10,50 |
| | 91105003 | 3 | 11 | 2517 | 504,6 | 471 | 125 | 40 | 45 | 2,5 | | | 15,80 |
| | 91105004 | 4 | 12 | 3020 | 504,6 | 471 | 158 | 52 | 51 | | 0,5 | | 17,34 |
| | 91105005 | 5 | 12 | 3030 | 504,6 | 471 | 148 | 64 | 76 | 6 | | | 22,60 |

MATERIAL **CAST-IRON**

CAD drawings available on our site
www.chiaravalli.com

Quantity, availability and prices
 on B2B Chiaravalli

www.bibiscom.ro

V-BELT PULLEYS for TAPER BUSHES



V-BELT PULLEYS for TAPER BUSHES

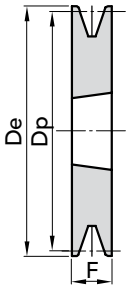

EXEC. 1

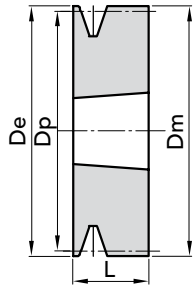

EXEC. 2

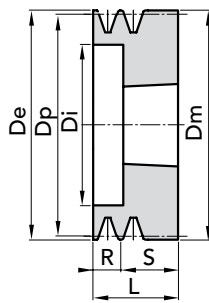

EXEC. 3

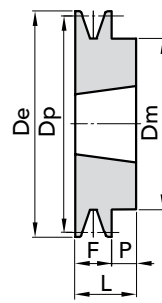

EXEC. 4

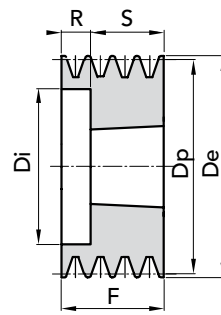

EXEC. 5

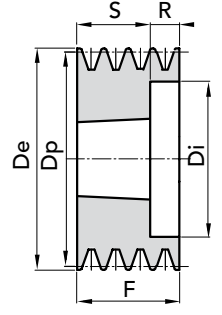

EXEC. 6

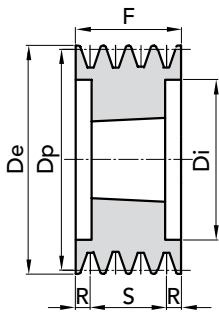

EXEC. 7

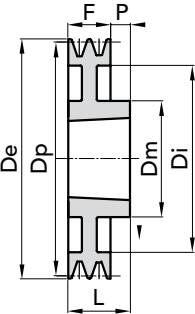

EXEC. 8

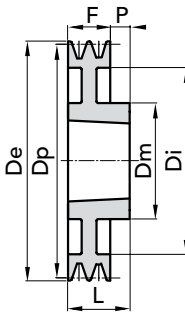

EXEC. 8A

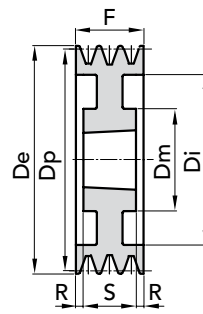

EXEC. 9

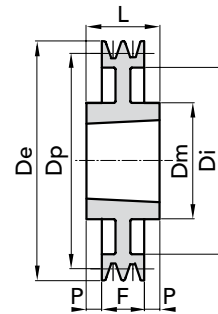

EXEC. 10

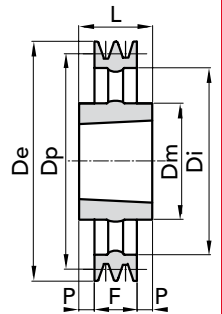

EXEC. 11

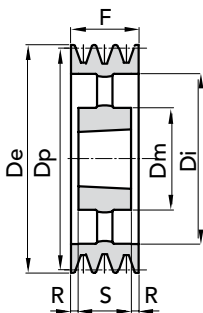

EXEC. 12

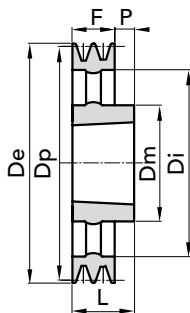

EXEC. 13

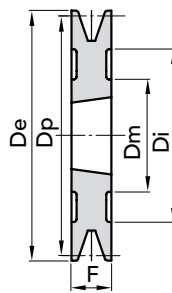

EXEC. 14

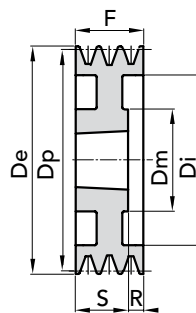

EXEC. 15

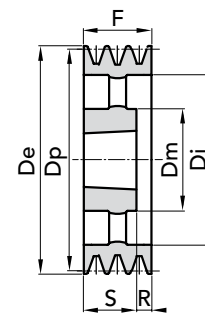

EXEC. 16

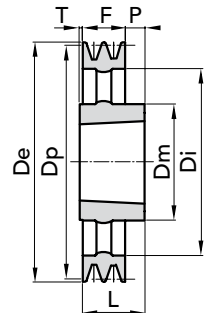

EXEC. 17



V-BELT PULLEYS for TAPER BUSHES

9

TAPER BUSHES

SPA TYPE

We are engaged to respect shapes and dimensions shown on this sheet but, we reserve the right to make changes and modifications without notice.

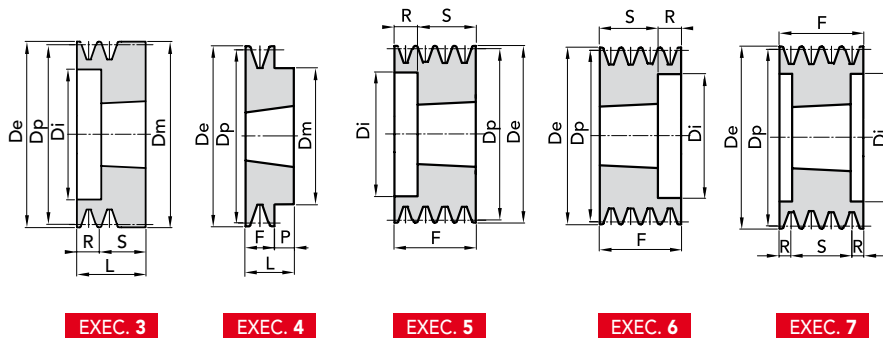

EXEC. 3

EXEC. 4

EXEC. 5

EXEC. 6

EXEC. 7

| Dp | P. NUMBER | N° | EXEC. | BUSHE | Ø De | Ø Di | Ø Dm | F | L | P | R | S | WEIGHT |
|---------|-----------|----|-------|-------|-------|------|------|----|----|---|------|----|--------|
| GROOVES | | | | | | | | | | | | | Kg. |
| 63 | 91200631 | 1 | 3 | 1008 | 69,1 | 37 | 56 | 20 | 40 | 2 | 18 | 22 | 0,80 |
| 71 | 91200711 | 1 | 4 | 1108 | 77,1 | | 62 | 20 | 22 | 2 | | | 0,50 |
| | 91200712 | 2 | 5 | 1108 | 77,1 | 40 | 62 | 35 | 22 | 2 | 13 | 22 | 0,60 |
| | 91200713 | 3 | 5 | 1108 | 77,1 | 40 | 62 | 50 | 22 | | 28 | 22 | 0,80 |
| 75 | 91200751 | 1 | 4 | 1108 | 81,1 | | 62 | 20 | 22 | 2 | | | 0,60 |
| | 91200752 | 2 | 5 | 1108 | 81,1 | 44 | 62 | 35 | 22 | | 13 | 22 | 0,70 |
| | 91200753 | 3 | 5 | 1108 | 81,1 | 44 | 62 | 50 | 22 | | 28 | 22 | 0,90 |
| 80 | 91200801 | 1 | 4 | 1210 | 86,1 | | 75 | 20 | 25 | 5 | | | 0,70 |
| | 91200802 | 2 | 5 | 1210 | 86,1 | 47 | 75 | 35 | 25 | | 10 | 25 | 0,70 |
| | 91200803 | 3 | 5 | 1210 | 86,1 | 47 | 75 | 50 | 25 | | 25 | 25 | 1,10 |
| 85 | 91200851 | 1 | 4 | 1210 | 91,1 | | 75 | 20 | 25 | 5 | | | 0,70 |
| | 91200852 | 2 | 5 | 1210 | 91,1 | 50 | 75 | 35 | 25 | | 10 | 25 | 0,80 |
| | 91200853 | 3 | 5 | 1210 | 91,1 | 50 | 75 | 50 | 25 | | 25 | 25 | 1,20 |
| 90 | 91200901 | 1 | 4 | 1210 | 96,1 | | 75 | 20 | 25 | 5 | | | 0,80 |
| | 91200902 | 2 | 5 | 1610 | 96,1 | 60 | 75 | 35 | 25 | | 10 | 25 | 0,90 |
| | 91200903 | 3 | 5 | 1610 | 96,1 | 60 | 75 | 50 | 25 | | 25 | 25 | 1,30 |
| 95 | 91200951 | 1 | 4 | 1210 | 101,1 | | 75 | 20 | 25 | 5 | | | 0,90 |
| | 91200952 | 2 | 5 | 1610 | 101,1 | 64 | 75 | 35 | 25 | | 10 | 25 | 1,00 |
| | 91200953 | 3 | 5 | 1610 | 101,1 | 64 | 75 | 50 | 25 | | 25 | 25 | 1,50 |
| | 91200954 | 4 | 7 | 1615 | 101,1 | 64 | 75 | 65 | 25 | | 13,5 | 38 | 1,40 |
| 100 | 91201001 | 1 | 4 | 1610 | 106,1 | | 80 | 20 | 25 | 5 | | | 1,00 |
| | 91201002 | 2 | 5 | 1610 | 106,1 | 70 | 80 | 35 | 25 | | 10 | 25 | 1,10 |
| | 91201003 | 3 | 6 | 1610 | 106,1 | 70 | 80 | 50 | 25 | | 25 | 25 | 1,30 |
| | 91201004 | 4 | 6 | 1615 | 106,1 | 70 | 80 | 65 | 25 | | 27 | 38 | 1,80 |
| | 91201005 | 5 | 6 | 1615 | 106,1 | 70 | 80 | 80 | 25 | | 42 | 38 | 2,10 |
| 106 | 91201061 | 1 | 4 | 1610 | 112,1 | | 80 | 20 | 25 | 5 | | | 1,20 |
| | 91201062 | 2 | 5 | 1610 | 112,1 | 76 | 80 | 35 | 25 | | 10 | 25 | 1,20 |
| | 91201063 | 3 | 6 | 1610 | 112,1 | 76 | 80 | 50 | 25 | | 25 | 25 | 1,60 |
| | 91201064 | 4 | 5 | 2012 | 112,1 | 76 | 80 | 65 | 25 | | 33 | 32 | 2,10 |
| | 91201065 | 5 | 5 | 2012 | 112,1 | 76 | 80 | 80 | 25 | | 48 | 32 | 2,30 |
| 112 | 91201121 | 1 | 4 | 1610 | 118,1 | | 80 | 20 | 25 | 5 | | | 1,30 |
| | 91201122 | 2 | 5 | 1610 | 118,1 | 80 | 80 | 35 | 25 | | 10 | 25 | 1,40 |
| | 91201123 | 3 | 5 | 2012 | 118,1 | 80 | 80 | 50 | 25 | | 18 | 32 | 1,60 |
| | 91201124 | 4 | 5 | 2012 | 118,1 | 80 | 80 | 65 | 25 | | 33 | 32 | 2,00 |
| | 91201125 | 5 | 5 | 2012 | 118,1 | 80 | 80 | 80 | 25 | | 48 | 32 | 2,50 |
| 118 | 91201181 | 1 | 4 | 1610 | 124,1 | | 80 | 20 | 25 | 5 | | | 1,40 |
| | 91201182 | 2 | 5 | 1610 | 124,1 | 86 | 80 | 35 | 25 | | 10 | 25 | 1,70 |
| | 91201183 | 3 | 6 | 2012 | 124,1 | 86 | 80 | 50 | 25 | | 18 | 32 | 1,90 |
| | 91201184 | 4 | 6 | 2012 | 124,1 | 86 | 80 | 65 | 25 | | 33 | 32 | 2,30 |
| | 91201185 | 5 | 6 | 2012 | 124,1 | 86 | 80 | 80 | 25 | | 48 | 32 | 2,80 |
| 125 | 91201251 | 1 | 4 | 1610 | 131,1 | | 80 | 20 | 25 | 5 | | | 1,50 |
| | 91201252 | 2 | 5 | 1610 | 131,1 | 90 | 80 | 35 | 25 | | 10 | 25 | 1,90 |
| | 91201253 | 3 | 6 | 2012 | 131,1 | 92 | 80 | 50 | 25 | | 18 | 32 | 2,70 |
| | 91201254 | 4 | 6 | 2012 | 131,1 | 92 | 80 | 65 | 25 | | 33 | 32 | 3,00 |
| | 91201255 | 5 | 7 | 2012 | 131,1 | 92 | 80 | 80 | 25 | | 24 | 32 | 3,00 |

MATERIAL **CAST-IRON**

CAD drawings available on our site
www.chiaravalli.com

Quantity, availability and prices
 on B2B Chiaravalli

www.bibiscom.ro

V-BELT PULLEYS for TAPER BUSHES



TAPER BUSHES

SPA TYPE

We are engaged to respect shapes and dimensions shown on this sheet but, we reserve the right to make changes and modifications without notice.

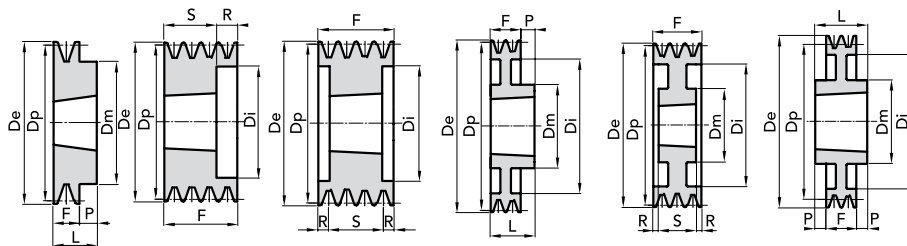

EXEC. 4

ESEC. 6

ESEC. 7

ESEC. 8

ESEC. 9

ESEC. 10

| Dp | P. NUMBER | N° | EXEC. | BUSHE | Ø De | Ø Di | Ø Dm | F | L | P | R | S | WEIGHT |
|---------|-----------|----|-------|-------|-------|------|------|----|----|----|------|----|--------|
| GROOVES | | | | | | | | | | | | | |
| Kg. | | | | | | | | | | | | | |
| 132 | 91201321 | 1 | 4 | 1610 | 138,1 | | 80 | 20 | 25 | 5 | | | 1,60 |
| | 91201322 | 2 | 5 | 2012 | 138,1 | 98 | | 35 | | | 3 | 32 | 2,10 |
| | 91201323 | 3 | 6 | 2012 | 138,1 | 98 | | 50 | | | 18 | 32 | 2,90 |
| | 91201324 | 4 | 6 | 2517 | 138,1 | 98 | | 65 | | | 20 | 45 | 3,20 |
| | 91201325 | 5 | 7 | 2517 | 138,1 | 98 | | 80 | | | 17,5 | 45 | 3,50 |
| 140 | 91201401 | 1 | 4 | 1610 | 146,1 | | 80 | 20 | 25 | 5 | | | 1,70 |
| | 91201402 | 2 | 5 | 2012 | 146,1 | 106 | | 35 | | | 3 | 32 | 2,60 |
| | 91201403 | 3 | 5 | 2517 | 146,1 | 106 | | 50 | | | 5 | 45 | 3,20 |
| | 91201404 | 4 | 6 | 2517 | 146,1 | 106 | | 65 | | | 20 | 45 | 3,50 |
| | 91201405 | 5 | 7 | 2517 | 146,1 | 106 | | 80 | | | 17,5 | 45 | 3,90 |
| 150 | 91201501 | 1 | 4 | 1610 | 156,1 | | 80 | 20 | 25 | 5 | | | 2,00 |
| | 91201502 | 2 | 5 | 2012 | 156,1 | 116 | | 35 | | | 3 | 32 | 3,20 |
| | 91201503 | 3 | 5 | 2517 | 156,1 | 116 | | 50 | | | 5 | 45 | 3,50 |
| | 91201504 | 4 | 6 | 2517 | 156,1 | 116 | | 65 | | | 20 | 45 | 3,90 |
| | 91201505 | 5 | 7 | 2517 | 156,1 | 116 | | 80 | | | 17,5 | 45 | 4,40 |
| 160 | 91201601 | 1 | 4 | 1610 | 166,1 | | 80 | 20 | 25 | 5 | | | 2,40 |
| | 91201602 | 2 | 5 | 2012 | 166,1 | 125 | | 35 | | | 3 | 32 | 3,60 |
| | 91201603 | 3 | 5 | 2517 | 166,1 | 126 | | 50 | | | 5 | 45 | 4,50 |
| | 91201604 | 4 | 6 | 2517 | 166,1 | 126 | | 65 | | | 20 | 45 | 5,10 |
| | 91201605 | 5 | 7 | 2517 | 166,1 | 126 | | 80 | | | 17,5 | 45 | 5,70 |
| 170 | 91201701 | 1 | 4 | 1610 | 176,1 | | 80 | 20 | 25 | 5 | | | 1,10 |
| | 91201702 | 2 | 5 | 2012 | 176,1 | 135 | | 35 | | | 3 | 32 | 4,50 |
| | 91201703 | 3 | 5 | 2517 | 176,1 | 138 | | 50 | | | 5 | 45 | 5,00 |
| | 91201704 | 4 | 6 | 2517 | 176,1 | 138 | | 65 | | | 20 | 45 | 5,80 |
| | 91201705 | 5 | 7 | 3020 | 176,1 | 138 | | 80 | | | 14,5 | 51 | 6,30 |
| 180 | 91201801 | 1 | 4 | 1610 | 186,1 | | 80 | 20 | 25 | 5 | | | 2,50 |
| | 91201802 | 2 | 9 | 2012 | 186,1 | 148 | 100 | 35 | | | 1,5 | 32 | 5,00 |
| | 91201803 | 3 | 5 | 2517 | 186,1 | 146 | | 50 | | | 5 | 45 | 6,20 |
| | 91201804 | 4 | 6 | 2517 | 186,1 | 146 | | 65 | | | 20 | 45 | 6,90 |
| | 91201805 | 5 | 7 | 3020 | 186,1 | 146 | | 80 | | | 14,5 | 51 | 6,90 |
| 190 | 91201901 | 1 | 4 | 1610 | 196,1 | | 80 | 20 | 25 | 5 | | | 2,80 |
| | 91201902 | 2 | 9 | 2012 | 196,1 | 158 | 100 | 35 | | | 1,5 | 32 | 4,40 |
| | 91201903 | 3 | 5 | 2517 | 196,1 | 158 | | 50 | | | 5 | 45 | 7,00 |
| | 91201904 | 4 | 6 | 2517 | 196,1 | 158 | | 65 | | | 20 | 45 | 6,80 |
| | 91201905 | 5 | 7 | 3020 | 196,1 | 158 | | 80 | | | 14,5 | 51 | 7,70 |
| 200 | 91202001 | 1 | 8 | 2012 | 206,1 | 165 | 100 | 20 | 32 | 12 | | | 2,30 |
| | 91202002 | 2 | 10 | 2517 | 206,1 | 165 | 120 | 35 | 45 | 5 | | | 4,90 |
| | 91202003 | 3 | 9 | 2517 | 206,1 | 165 | 120 | 50 | | | 2,5 | 45 | 5,80 |
| | 91202004 | 4 | 6 | 3020 | 206,1 | 165 | | 65 | | | 14 | 51 | 8,40 |
| | 91202005 | 5 | 7 | 3020 | 206,1 | 165 | | 80 | | | 14,5 | 51 | 9,00 |
| 212 | 91202121 | 1 | 8 | 2012 | 218,1 | 177 | 100 | 20 | 32 | 12 | | | 3,50 |
| | 91202122 | 2 | 10 | 2517 | 218,1 | 177 | 120 | 35 | 45 | 5 | | | 5,80 |
| | 91202123 | 3 | 9 | 2517 | 218,1 | 177 | 120 | 50 | | | 2,5 | 45 | 6,60 |
| | 91202124 | 4 | 6 | 3020 | 218,1 | 177 | | 65 | | | 14 | 51 | 9,90 |
| | 91202125 | 5 | 7 | 3020 | 218,1 | 177 | | 80 | | | 14,5 | 51 | 10,70 |

MATERIAL CAST-IRON

CAD drawings available on our site
www.chiaravalli.com

Quantity, availability and prices
 on B2B Chiaravalli

www.bibiscom.ro



V-BELT PULLEYS for TAPER BUSHES

11

TAPER BUSHES

SPA TYPE

We are engaged to respect shapes and dimensions shown on this sheet but, we reserve the right to make changes and modifications without notice.

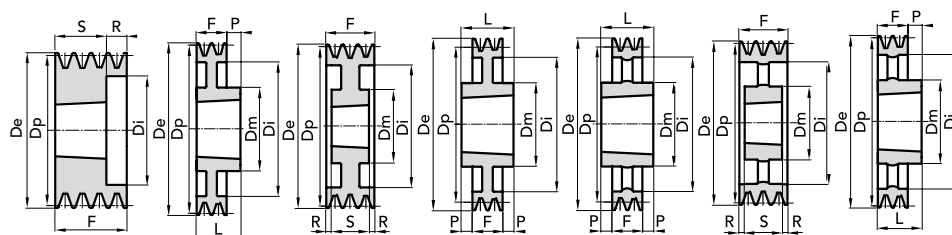

EXEC. 6

EXEC. 8

EXEC. 9

EXEC. 10

EXEC. 11

EXEC. 12

EXEC. 13

| Dp | P. NUMBER | N° | EXEC. | BUSHE | Ø De | Ø Di | Ø Dm | F | L | P | R | S | WEIGHT |
|---------|-----------|----|-------|-------|-------|------|------|----|----|-----|------|----|--------|
| GROOVES | | | | | | | | | | | | | Kg. |
| 224 | 91202241 | 1 | 8 | 2012 | 230,1 | 189 | 100 | 20 | 32 | 12 | | | 4,00 |
| | 91202242 | 2 | 8 | 2517 | 230,1 | 189 | 120 | 35 | 45 | 10 | | | 6,60 |
| | 91202243 | 3 | 9 | 2517 | 230,1 | 189 | 120 | 50 | | | 2,5 | 45 | 7,50 |
| | 91202244 | 4 | 6 | 3020 | 230,1 | 189 | | 65 | | | 14 | 51 | 11,40 |
| | 91202245 | 5 | 6 | 3020 | 230,1 | 189 | | 80 | | | 29 | 51 | 12,30 |
| 236 | 91202361 | 1 | 8 | 2012 | 242,1 | 202 | 106 | 20 | 32 | 12 | | | 3,60 |
| | 91202362 | 2 | 8 | 2517 | 242,1 | 202 | 125 | 35 | 45 | 10 | | | 5,40 |
| | 91202363 | 3 | 9 | 2517 | 242,1 | 202 | 125 | 50 | | | 2,5 | 45 | 6,60 |
| | 91202364 | 4 | 9 | 3020 | 242,1 | 202 | 146 | 65 | | | 7 | 51 | 9,80 |
| | 91202365 | 5 | 9 | 3020 | 242,1 | 202 | 155 | 80 | | | 14,5 | 51 | 11,20 |
| 250 | 91202501 | 1 | 10 | 2012 | 256,1 | 215 | 100 | 20 | 32 | 6 | | | 4,20 |
| | 91202502 | 2 | 10 | 2517 | 256,1 | 215 | 120 | 35 | 45 | 5 | | | 6,80 |
| | 91202503 | 3 | 9 | 2517 | 256,1 | 215 | 120 | 50 | | | 2,5 | 45 | 6,80 |
| | 91202504 | 4 | 9 | 3020 | 256,1 | 215 | 150 | 65 | | | 7 | 51 | 10,50 |
| | 91202505 | 5 | 9 | 3020 | 256,1 | 215 | 150 | 80 | | | 14,5 | 51 | 11,70 |
| 280 | 91202801 | 1 | 8 | 2012 | 286,1 | 245 | 100 | 20 | 32 | 12 | | | 6,30 |
| | 91202802 | 2 | 8 | 2517 | 286,1 | 245 | 120 | 35 | 45 | 10 | | | 8,30 |
| | 91202803 | 3 | 9 | 2517 | 286,1 | 245 | 120 | 50 | | | 2,5 | 45 | 10,00 |
| | 91202804 | 4 | 9 | 3020 | 286,1 | 245 | 150 | 65 | | | 7 | 51 | 11,50 |
| | 91202805 | 5 | 10 | 3535 | 286,1 | 245 | 170 | 80 | 89 | 4,5 | | | 17,40 |
| 300 | 91203001 | 1 | 8 | 2012 | 306,1 | 264 | 112 | 20 | 32 | 12 | | | 5,20 |
| | 91203002 | 2 | 8 | 2517 | 306,1 | 264 | 125 | 35 | 45 | 10 | | | 6,80 |
| | 91203003 | 3 | 10 | 3020 | 306,1 | 264 | 146 | 50 | 51 | 0,5 | | | 9,10 |
| | 91203004 | 4 | 9 | 3020 | 306,1 | 264 | 146 | 65 | | | 7 | 51 | 12,40 |
| | 91203005 | 5 | 8 | 3535 | 306,1 | 264 | 175 | 80 | 89 | 9 | | | 16,50 |
| 315 | 91203151 | 1 | 13 | 2012 | 321,1 | 280 | 100 | 20 | 32 | 12 | | | 7,20 |
| | 91203152 | 2 | 13 | 2517 | 321,1 | 280 | 120 | 35 | 45 | 10 | | | 10,20 |
| | 91203153 | 3 | 10 | 3020 | 321,1 | 280 | 150 | 50 | 51 | 0,5 | | | 12,80 |
| | 91203154 | 4 | 9 | 3020 | 321,1 | 280 | 150 | 65 | | | 7 | 51 | 13,80 |
| | 91203155 | 5 | 10 | 3535 | 321,1 | 280 | 170 | 80 | 89 | 4,5 | | | 20,00 |
| 335 | 91203353 | 3 | 11 | 3020 | 341,1 | 300 | 150 | 50 | 51 | 0,5 | | | 11,40 |
| | 91203354 | 4 | 12 | 3020 | 341,1 | 300 | 150 | 65 | | | 7 | 51 | 13,20 |
| | 91203355 | 5 | 10 | 3535 | 341,1 | 300 | 170 | 80 | 89 | 4,5 | | | 19,00 |
| 355 | 91203551 | 1 | 13 | 2012 | 361,1 | 320 | 100 | 20 | 32 | 12 | | | 7,70 |
| | 91203552 | 2 | 13 | 2517 | 361,1 | 320 | 120 | 35 | 45 | 10 | | | 10,50 |
| | 91203553 | 3 | 11 | 3020 | 361,1 | 320 | 150 | 50 | 51 | 0,5 | | | 13,40 |
| | 91203554 | 4 | 12 | 3020 | 361,1 | 320 | 150 | 65 | | | 7 | 51 | 15,80 |
| | 91203555 | 5 | 11 | 3535 | 361,1 | 320 | 170 | 80 | 89 | 4,5 | | | 22,80 |
| 400 | 91204001 | 1 | 13 | 2012 | 406,1 | 365 | 100 | 20 | 32 | 12 | | | 7,90 |
| | 91204002 | 2 | 13 | 2517 | 406,1 | 365 | 120 | 35 | 45 | 10 | | | 11,30 |
| | 91204003 | 3 | 11 | 3020 | 406,1 | 365 | 150 | 50 | 51 | 0,5 | | | 15,90 |
| | 91204004 | 4 | 12 | 3020 | 406,1 | 365 | 150 | 65 | | | 7 | 51 | 17,70 |
| | 91204005 | 5 | 11 | 3535 | 406,1 | 365 | 170 | 80 | 89 | 4,5 | | | 24,80 |

MATERIAL **CAST-IRON**

CAD drawings available on our site
www.chiaravalli.com

Quantity, availability and prices
 on B2B Chiaravalli

www.bibiscom.ro

V-BELT PULLEYS for TAPER BUSHES



TAPER BUSHES

SPA TYPE

We are engaged to respect shapes and dimensions shown on this sheet but, we reserve the right to make changes and modifications without notice.

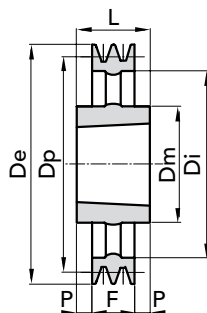

EXEC. 11

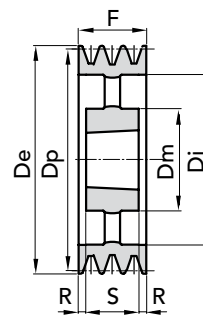

EXEC. 12

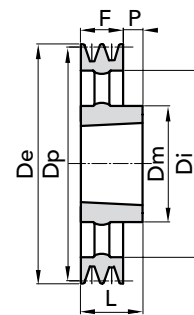

EXEC. 13

| Dp | P. NUMBER | N° | EXEC. | BUSHE | Ø De | Ø Di | Ø Dm | F | L | P | R | S | WEIGHT Kg. |
|----------------|-----------|----|-------|-------|-------|------|------|----|-----|------|---|----|---------------|
| GROOVES | | | | | | | | | | | | | |
| 450 | 91204501 | 1 | 13 | 2012 | 456,1 | 415 | 100 | 20 | 32 | 12 | | | 8,30 |
| | 91204502 | 2 | 13 | 2517 | 456,1 | 415 | 120 | 35 | 45 | 10 | | | 15,00 |
| | 91204503 | 3 | 11 | 3020 | 456,1 | 415 | 150 | 50 | 51 | 0,5 | | | 19,30 |
| | 91204504 | 4 | 12 | 3020 | 456,1 | 415 | 150 | 65 | | | 7 | 51 | 23,20 |
| | 91204505 | 5 | 11 | 3535 | 456,1 | 415 | 170 | 80 | 89 | 4,5 | | | 28,50 |
| 500 | 91205001 | 1 | 13 | 2517 | 506,1 | 465 | 120 | 20 | 45 | 25 | | | 9,40 |
| | 91205002 | 2 | 13 | 2517 | 506,1 | 465 | 120 | 35 | 45 | 10 | | | 18,70 |
| | 91205003 | 3 | 11 | 3020 | 506,1 | 465 | 150 | 50 | 51 | 0,5 | | | 22,60 |
| | 91205004 | 4 | 12 | 3020 | 506,1 | 465 | 150 | 65 | | | 7 | 51 | 27,40 |
| | 91205005 | 5 | 11 | 3535 | 506,1 | 465 | 170 | 80 | 89 | 4,5 | | | 31,70 |
| 560 | 91205603 | 3 | 13 | 3020 | 566,1 | 525 | 150 | 50 | 51 | 0,5 | | | 23,50 |
| | 91205604 | 4 | 11 | 3535 | 566,1 | 525 | 170 | 65 | 89 | 12 | | | 30,50 |
| | 91205605 | 5 | 11 | 3535 | 566,1 | 525 | 170 | 80 | 89 | 4,5 | | | 35,00 |
| 630 | 91206302 | 2 | 13 | 3020 | 636,1 | 595 | 150 | 35 | 51 | 16 | | | 22,00 |
| | 91206303 | 3 | 11 | 3020 | 636,1 | 595 | 150 | 50 | 51 | 0,5 | | | 27,50 |
| | 91206304 | 4 | 11 | 3535 | 636,1 | 595 | 170 | 65 | 89 | 12 | | | 34,10 |
| | 91206305 | 5 | 11 | 3535 | 636,1 | 595 | 170 | 80 | 89 | 4,5 | | | 42,00 |
| | 91206306 | 6 | 11 | 4040 | 636,1 | 595 | 200 | 95 | 102 | 3,5 | | | 53,50 |
| 800 | 91208003 | 3 | 11 | 3535 | 806,1 | 765 | 170 | 50 | 89 | 19,5 | | | 40,80 |
| | 91208004 | 4 | 11 | 3535 | 806,1 | 765 | 170 | 65 | 89 | 12 | | | 50,80 |
| | 91208005 | 5 | 11 | 4040 | 806,1 | 765 | 200 | 80 | 102 | 11 | | | 60,00 |

MATERIAL **CAST-IRON**

CAD drawings available on our site
www.chiaravalli.com

Quantity, availability and prices
 on B2B Chiaravalli

www.bibiscom.ro



V-BELT PULLEYS for TAPER BUSHES

13

TAPER BUSHES

SPB TYPE

We are engaged to respect shapes and dimensions shown on this sheet but, we reserve the right to make changes and modifications without notice.

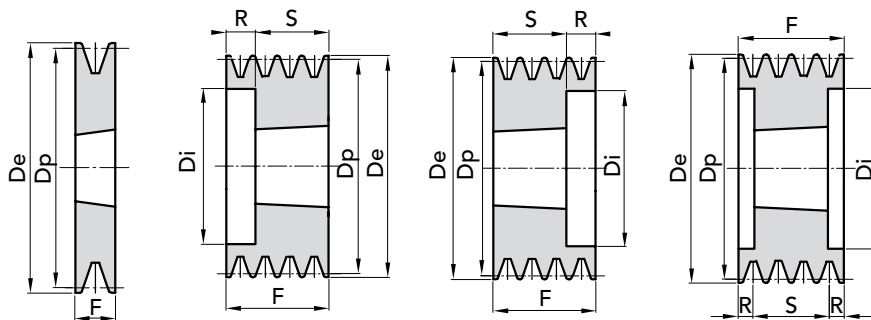

EXEC. 1

EXEC. 5

EXEC. 6

EXEC. 7

| Dp | P. NUMBER | N° | EXEC. | BUSHE | Ø De | Ø Di | Ø Dm | F | L | P | R | S | WEIGHT |
|----------|-----------|----------|-------|-------|-------|-------|------|-----|----|---|------|----|--------|
| GROOVES | | | | | | | | | | | | | Kg. |
| 100 | 91301001 | 1 | 1 | 1610 | 107,6 | | | 25 | | | | | 0,90 |
| | 91301002 | 2 | 6 | 1610 | 107,6 | 57 | | 44 | | | 19 | 25 | 1,40 |
| 106 | 91301061 | 1 | 1 | 1610 | 113,6 | | | 25 | | | | | 1,00 |
| | 91301062 | 2 | 6 | 1610 | 113,6 | 67 | | 44 | | | 19 | 25 | 1,60 |
| | 91301063 | 3 | 6 | 1610 | 113,6 | 67 | | 63 | | | 38 | 25 | 2,20 |
| 112 | 91301121 | 1 | 1 | 1610 | 119,6 | | | 25 | | | | | 1,20 |
| | 91301122 | 2 | 6 | 1610 | 119,6 | 72 | | 44 | | | 19 | 25 | 1,70 |
| | 91301123 | 3 | 6 | 1610 | 119,6 | 72 | | 63 | | | 38 | 25 | 2,40 |
| 118 | 91301181 | 1 | 1 | 1610 | 125,6 | | | 25 | | | | | 1,30 |
| | 91301182 | 2 | 6 | 1610 | 125,6 | 78 | | 44 | | | 19 | 25 | 1,80 |
| | 91301183 | 3 | 6 | 1610 | 125,6 | 78 | | 63 | | | 38 | 25 | 2,60 |
| 125 | 91301251 | 1 | 1 | 1610 | 132,6 | | | 25 | | | | | 1,50 |
| | 91301252 | 2 | 6 | 2012 | 132,6 | 82 | | 44 | | | 12 | 32 | 1,90 |
| | 91301253 | 3 | 6 | 2012 | 132,6 | 82 | | 63 | | | 31 | 32 | 2,50 |
| | 91301254 | 4 | 7 | 2012 | 132,6 | 82 | | 82 | | | 25 | 32 | 3,00 |
| | 91301255 | 5 | 5/6 | 2012 | 132,6 | 82 | | 101 | | | 69 | 32 | 3,60 |
| 132 | 91301321 | 1 | 1 | 1610 | 139,6 | | | 25 | | | | | 1,70 |
| | 91301322 | 2 | 6 | 2012 | 139,6 | 89 | | 44 | | | 12 | 32 | 2,50 |
| | 91301323 | 3 | 6 | 2012 | 139,6 | 89 | | 63 | | | 31 | 32 | 3,20 |
| | 91301324 | 4 | 7 | 2012 | 139,6 | 89 | | 82 | | | 25 | 32 | 3,70 |
| | 91301325 | 5 | 5 | 2517 | 139,6 | 89 | | 101 | | | 56 | 45 | 3,80 |
| 140 | 91301401 | 1 | 1 | 1610 | 147,6 | | | 25 | | | | | 1,80 |
| | 91301402 | 2 | 6 | 2012 | 147,6 | 97 | | 44 | | | 12 | 32 | 2,70 |
| | 91301403 | 3 | 6 | 2012 | 147,6 | 97 | | 63 | | | 31 | 32 | 3,60 |
| | 91301404 | 4 | 7 | 2517 | 147,6 | 97 | | 82 | | | 18,5 | 45 | 4,30 |
| | 91301405 | 5 | 7 | 2517 | 147,6 | 97 | | 101 | | | 28 | 45 | 4,40 |
| | 91301406 | 6 | 7 | 2517 | 147,6 | 97 | | 120 | | | 37,5 | 45 | 4,70 |
| | 91301408 | 8 | 7 | 2517 | 147,6 | 97 | | 158 | | | 56,5 | 45 | 7,00 |
| | 150 | 91301501 | 1 | 1 | 1610 | 157,6 | | | 25 | | | | |
| 91301502 | | 2 | 6 | 2012 | 157,6 | 107 | | 44 | | | 12 | 32 | 3,20 |
| 91301503 | | 3 | 6 | 2517 | 157,6 | 107 | | 63 | | | 18 | 45 | 4,00 |
| 91301504 | | 4 | 7 | 2517 | 157,6 | 107 | | 82 | | | 18,5 | 45 | 4,60 |
| 91301505 | | 5 | 7 | 2517 | 157,6 | 107 | | 101 | | | 28 | 45 | 5,40 |
| 91301506 | | 6 | 7 | 2517 | 157,6 | 107 | | 120 | | | 37,5 | 45 | 6,80 |
| 160 | 91301601 | 1 | 1 | 1610 | 167,6 | | | 25 | | | | | 2,50 |
| | 91301602 | 2 | 6 | 2012 | 167,6 | 117 | | 44 | | | 12 | 32 | 3,80 |
| | 91301603 | 3 | 6 | 2517 | 167,6 | 117 | | 63 | | | 18 | 45 | 4,50 |
| | 91301604 | 4 | 7 | 2517 | 167,6 | 117 | | 82 | | | 18,5 | 45 | 5,80 |
| | 91301605 | 5 | 7 | 2517 | 167,6 | 117 | | 101 | | | 28 | 45 | 6,70 |
| | 91301606 | 6 | 7 | 3020 | 167,6 | 117 | | 120 | | | 34,5 | 51 | 7,20 |
| | 91301608 | 8 | 7 | 3020 | 167,6 | 117 | | 158 | | | 53,5 | 51 | 8,30 |

MATERIAL **CAST-IRON**

CAD drawings available on our site
www.chiaravalli.com

Quantity, availability and prices
 on B2B Chiaravalli

www.bibiscom.ro

V-BELT PULLEYS for TAPER BUSHES



V-BELT PULLEYS for TAPER BUSHES

TAPER BUSHES

SPB TYPE

We are engaged to respect shapes and dimensions shown on this sheet but, we reserve the right to make changes and modifications without notice.

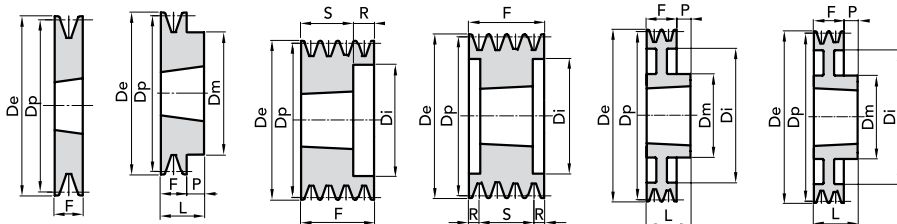

EXEC. 1

EXEC. 4

EXEC. 6

EXEC. 7

EXEC. 8

EXEC. 8A

| Dp | P. NUMBER | N° | EXEC. | BUSHE | Ø De | Ø Di | Ø Dm | F | L | P | R | S | WEIGHT |
|----------|-----------|----------|-------|-------|-------|-------|------|-----|----|----|------|----|--------|
| GROOVES | | | | | | | | | | | | | |
| Kg. | | | | | | | | | | | | | |
| 170 | 91301701 | 1 | 1 | 1610 | 177,6 | | | 25 | | | | | 2,90 |
| | 91301702 | 2 | 6 | 2012 | 177,6 | 127 | | 44 | | | 12 | 32 | 4,80 |
| | 91301703 | 3 | 6 | 2517 | 177,6 | 127 | | 63 | | | 18 | 45 | 5,30 |
| | 91301704 | 4 | 7 | 2517 | 177,6 | 127 | | 82 | | | 18,5 | 45 | 6,70 |
| | 91301705 | 5 | 7 | 3020 | 177,6 | 127 | | 101 | | | 25 | 51 | 7,10 |
| | 91301706 | 6 | 7 | 3020 | 177,6 | 127 | | 120 | | | 34,5 | 51 | 7,60 |
| 180 | 91301801 | 1 | 14 | 1610 | 187,6 | 137 | 80 | 25 | | | | | 3,80 |
| | 91301802 | 2 | 4 | 2517 | 187,6 | | 120 | 44 | 45 | 1 | | | 5,50 |
| | 91301803 | 3 | 6 | 2517 | 187,6 | 137 | | 63 | | | 18 | 45 | 6,70 |
| | 91301804 | 4 | 7 | 2517 | 187,6 | 137 | | 82 | | | 18,5 | 45 | 7,70 |
| | 91301805 | 5 | 7 | 3020 | 187,6 | 137 | | 101 | | | 25 | 51 | 8,20 |
| | 91301806 | 6 | 7 | 3020 | 187,6 | 137 | | 120 | | | 34,5 | 51 | 10,20 |
| | 91301808 | 8 | 7 | 3030 | 187,6 | 137 | | 158 | | | 41 | 76 | 10,80 |
| | 190 | 91301901 | 1 | 10 | 2012 | 197,6 | 147 | 100 | 25 | 32 | 3,5 | | |
| 91301902 | | 2 | 4 | 2517 | 197,6 | | 120 | 44 | 45 | 1 | | | 6,50 |
| 91301903 | | 3 | 6 | 2517 | 197,6 | 147 | | 63 | | | 18 | 45 | 7,60 |
| 91301904 | | 4 | 7 | 2517 | 197,6 | 147 | | 82 | | | 18,5 | 45 | 8,60 |
| 91301905 | | 5 | 7 | 3020 | 197,6 | 147 | | 101 | | | 25 | 51 | 9,10 |
| 91301906 | | 6 | 7 | 3020 | 197,6 | 147 | | 120 | | | 34,5 | 51 | 10,20 |
| 91301908 | | 8 | 7 | 3030 | 197,6 | 147 | | 158 | | | 41 | 76 | 12,30 |
| 200 | | 91302001 | 1 | 10 | 2012 | 207,6 | 157 | 100 | 25 | 32 | 3,5 | | |
| | 91302002 | 2 | 4 | 2517 | 207,6 | 157 | 120 | 44 | 45 | 1 | | | 7,50 |
| | 91302003 | 3 | 6 | 2517 | 207,6 | 157 | | 63 | | | 18 | 45 | 8,90 |
| | 91302004 | 4 | 6/7 | 3020 | 207,6 | 157 | | 82 | | | 18,5 | 45 | 9,10 |
| | 91302005 | 5 | 7 | 3020 | 207,6 | 157 | | 101 | | | 25 | 51 | 10,30 |
| | 91302006 | 6 | 7 | 3020 | 207,6 | 157 | | 120 | | | 34,5 | 51 | 11,70 |
| | 91302008 | 8 | 7 | 3535 | 207,6 | 161 | | 158 | | | 34,5 | 89 | 13,70 |
| | 212 | 91302121 | 1 | 10 | 2012 | 219,6 | 169 | 100 | 25 | 32 | 3,5 | | |
| 91302122 | | 2 | 8 | 2517 | 219,6 | 169 | 120 | 44 | 45 | 1 | | | 7,00 |
| 91302123 | | 3 | 15 | 2517 | 219,6 | 169 | 120 | 63 | | | 18 | 45 | 8,20 |
| 91302124 | | 4 | 7 | 3020 | 219,6 | 169 | | 82 | | | 15,5 | 51 | 10,90 |
| 91302125 | | 5 | 7 | 3020 | 219,6 | 169 | | 101 | | | 25 | 51 | 12,20 |
| 91302126 | | 6 | 7 | 3535 | 219,6 | 169 | | 120 | | | 15,5 | 89 | 13,20 |
| 91302128 | | 8 | 7 | 3535 | 219,6 | 173 | | 158 | | | 34,5 | 89 | 15,80 |
| 224 | | 91302241 | 1 | 10 | 2012 | 231,6 | 181 | 100 | 25 | 32 | 3,5 | | |
| | 91302242 | 2 | 8a | 2517 | 231,6 | 181 | 120 | 44 | 45 | 1 | | | 7,70 |
| | 91302243 | 3 | 15 | 2517 | 231,6 | 181 | 120 | 63 | | | 18 | 45 | 9,10 |
| | 91302244 | 4 | 6/7 | 3020 | 231,6 | 181 | | 82 | | | 15,5 | 51 | 12,40 |
| | 91302245 | 5 | 7 | 3020 | 231,6 | 181 | | 101 | | | 25 | 51 | 13,70 |
| | 91302246 | 6 | 7 | 3535 | 231,6 | 181 | | 120 | | | 15,5 | 89 | 15,20 |
| | 91302248 | 8 | 7 | 3535 | 231,6 | 181 | | 158 | | | 34,5 | 89 | 17,20 |
| | 91302210 | 10 | 7 | 3535 | 231,6 | 181 | | 196 | | | 53,5 | 89 | 20,50 |

MATERIAL **CAST-IRON**

CAD drawings available on our site
www.chiaravalli.com

EXEC. 10

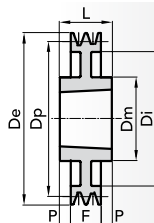

EXEC. 14

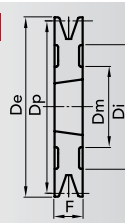

EXEC. 15

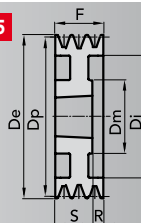



V-BELT PULLEYS for TAPER BUSHES

15

TAPER BUSHES

SPB TYPE

We are engaged to respect shapes and dimensions shown on this sheet but, we reserve the right to make changes and modifications without notice.

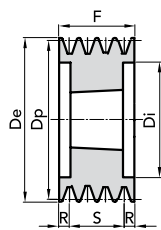

EXEC. 7

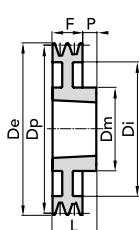

EXEC. 8A

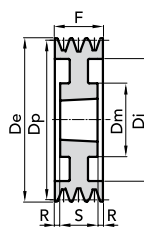

EXEC. 9

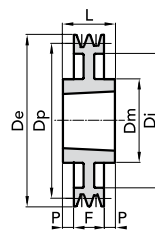

EXEC. 10

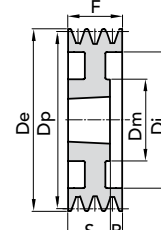

EXEC. 15

| Dp | P. NUMBER | N° | EXEC. | BUSHE | Ø De | Ø Di | Ø Dm | F | L | P | R | S | WEIGHT |
|---------|-----------|----|-------|-------|-------|------|------|-----|----|-----|------|----|--------|
| GROOVES | | | | | | | | | | | | | Kg. |
| 236 | 91302361 | 1 | 10 | 2012 | 243,6 | 193 | 100 | 25 | 32 | 3,5 | | | 5,40 |
| | 91302362 | 2 | 8a | 2517 | 243,6 | 193 | 120 | 44 | 45 | 1 | | | 8,30 |
| | 91302363 | 3 | 15 | 2517 | 243,6 | 193 | 120 | 63 | | | 18 | 45 | 9,80 |
| | 91302364 | 4 | 7 | 3020 | 243,6 | 193 | | 82 | | | 15,5 | 51 | 14,10 |
| | 91302365 | 5 | 7 | 3535 | 243,6 | 193 | | 101 | | | 6 | 89 | 16,20 |
| | 91302366 | 6 | 7 | 3535 | 243,6 | 193 | | 120 | | | 15,5 | 89 | 17,60 |
| | 91302368 | 8 | 7 | 3535 | 243,6 | 193 | | 158 | | | 34,5 | 89 | 20,00 |
| 250 | 91302501 | 1 | 10 | 2012 | 257,6 | 207 | 100 | 25 | 32 | 3,5 | | | 6,200 |
| | 91302502 | 2 | 8a | 2517 | 257,6 | 207 | 120 | 44 | 45 | 1 | | | 8,600 |
| | 91302503 | 3 | 15 | 3020 | 257,6 | 207 | 150 | 63 | | | 12 | 51 | 11,20 |
| | 91302504 | 4 | 9 | 3020 | 257,6 | 207 | 150 | 82 | | | 15,5 | 51 | 12,70 |
| | 91302505 | 5 | 7 | 3535 | 257,6 | 207 | | 101 | | | 6 | 89 | 18,60 |
| | 91302506 | 6 | 7 | 3535 | 257,6 | 207 | | 120 | | | 15,5 | 89 | 20,20 |
| | 91302508 | 8 | 7 | 3535 | 257,6 | 207 | | 158 | | | 34,5 | 89 | 23,20 |
| 280 | 91302801 | 1 | 10 | 2012 | 287,6 | 237 | 100 | 25 | 32 | 3,5 | | | 6,50 |
| | 91302802 | 2 | 8a | 2517 | 287,6 | 237 | 120 | 44 | 45 | 1 | | | 10,10 |
| | 91302803 | 3 | 9 | 3020 | 287,6 | 237 | 150 | 63 | | | 6 | 51 | 12,00 |
| | 91302804 | 4 | 9 | 3020 | 287,6 | 237 | 150 | 82 | | | 15,5 | 51 | 14,10 |
| | 91302805 | 5 | 9 | 3535 | 287,6 | 237 | 170 | 101 | | | 6 | 89 | 21,40 |
| | 91302806 | 6 | 9 | 3535 | 287,6 | 237 | 170 | 120 | | | 15,5 | 89 | 23,50 |
| | 91302808 | 8 | 9 | 3535 | 287,6 | 237 | 175 | 158 | | | 34,5 | 89 | 26,60 |
| 300 | 91303001 | 1 | 10 | 2012 | 307,6 | 257 | 100 | 25 | 32 | 3,5 | | | 7,00 |
| | 91303002 | 2 | 8a | 2517 | 307,6 | 257 | 120 | 44 | 45 | 1 | | | 11,00 |
| | 91303003 | 3 | 9 | 3020 | 307,6 | 257 | 150 | 63 | | | 6 | 51 | 13,50 |
| | 91303004 | 4 | 9 | 3020 | 307,6 | 257 | 150 | 82 | | | 15,5 | 51 | 20,50 |
| | 91303005 | 5 | 9 | 3535 | 307,6 | 257 | 170 | 101 | | | 6 | 89 | 22,50 |
| | 91303006 | 6 | 9 | 3535 | 307,6 | 257 | 170 | 120 | | | 15,5 | 89 | 24,00 |
| | 91303008 | 8 | 9 | 3535 | 307,6 | 257 | 175 | 158 | | | 34,5 | 89 | 27,30 |
| 315 | 91303151 | 1 | 10 | 2012 | 322,6 | 272 | 100 | 25 | 32 | 3,5 | | | 7,50 |
| | 91303152 | 2 | 8a | 2517 | 322,6 | 272 | 120 | 44 | 45 | 1 | | | 12,20 |
| | 91303153 | 3 | 9 | 3020 | 322,6 | 272 | 150 | 63 | | | 6 | 51 | 14,20 |
| | 91303154 | 4 | 10 | 3535 | 322,6 | 272 | 170 | 82 | 89 | 3,5 | | | 20,60 |
| | 91303155 | 5 | 9 | 3535 | 322,6 | 272 | 170 | 101 | | | 6 | 89 | 22,30 |
| | 91303156 | 6 | 9 | 3535 | 322,6 | 272 | 170 | 120 | | | 15,5 | 89 | 24,20 |
| | 91303158 | 8 | 9 | 3535 | 322,6 | 272 | 175 | 158 | | | 34,5 | 89 | 28,00 |
| 335 | 91303352 | 2 | 8a | 2517 | 342,6 | 292 | 120 | 44 | 45 | 1 | | | 14,00 |
| | 91303353 | 3 | 9 | 3020 | 342,6 | 292 | 150 | 63 | | | 6 | 51 | 16,00 |
| | 91303354 | 4 | 10 | 3535 | 342,6 | 292 | 170 | 82 | 89 | 3,5 | | | 22,00 |
| | 91303355 | 5 | 9 | 3535 | 342,6 | 292 | 170 | 101 | | | 6 | 89 | 24,00 |
| | 91303356 | 6 | 9 | 3535 | 342,6 | 292 | 170 | 120 | | | 15,5 | 89 | 26,30 |
| | 91303358 | 8 | 9 | 3535 | 342,6 | 292 | 175 | 158 | | | 34,5 | 89 | 30,50 |

MATERIAL CAST-IRON

CAD drawings available on our site
www.chiaravalli.com

Quantity, availability and prices
 on B2B Chiaravalli

www.bibiscom.ro

V-BELT PULLEYS for TAPER BUSHES



TAPER BUSHES

SPB TYPE

We are engaged to respect shapes and dimensions shown on this sheet but, we reserve the right to make changes and modifications without notice.

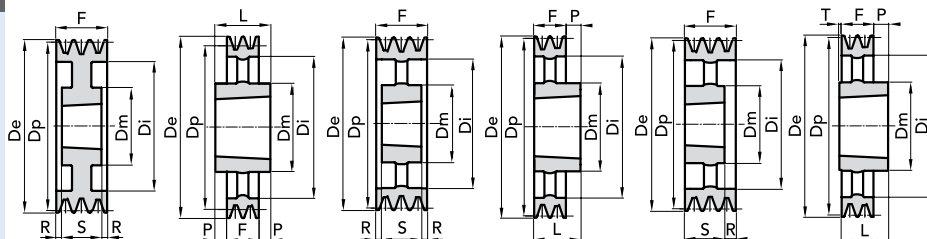

EXEC. 9

EXEC. 11

EXEC. 12

EXEC. 13

EXEC. 16

EXEC. 17

| Dp | P. NUMBER | N° | EXEC. | BUSHE | Ø De | Ø Di | Ø Dm | F | L | P | R | S | T | WEIGHT Kg. | |
|----------------|-----------|----------|-------|-------|-------|-------|------|-----|-----|-----|------|-----|-----|---------------|-------|
| GROOVES | | | | | | | | | | | | | | | |
| 355 | 91303552 | 2 | 11 | 3020 | 362,6 | 312 | 150 | 44 | 51 | 3,5 | | | | 15,90 | |
| | 91303553 | 3 | 12 | 3020 | 362,6 | 312 | 150 | 63 | | | 6 | 51 | | 17,70 | |
| | 91303554 | 4 | 10 | 3535 | 362,6 | 312 | 170 | 82 | 89 | 3,5 | | | | 23,20 | |
| | 91303555 | 5 | 12 | 3535 | 362,6 | 312 | 170 | 101 | | | 6 | 89 | | 25,50 | |
| | 91303556 | 6 | 9 | 3535 | 362,6 | 312 | 170 | 120 | | | 15,5 | 89 | | 28,40 | |
| | 91303558 | 8 | 9 | 3535 | 362,6 | 312 | 170 | 158 | | | 35,5 | 89 | | 31,50 | |
| | 91303510 | 10 | 9 | 4030 | 362,6 | 312 | 210 | 196 | | | | 60 | 76 | | 33,50 |
| 375 | 91303754 | 4 | 10 | 3535 | 382,6 | 332 | 170 | 82 | 89 | 3,5 | | | | 27,00 | |
| 400 | 91304002 | 2 | 11 | 3020 | 407,6 | 357 | 150 | 44 | 51 | 3,5 | | | | 18,30 | |
| | 91304003 | 3 | 11 | 3535 | 407,6 | 357 | 170 | 63 | 89 | 13 | | | | 25,00 | |
| | 91304004 | 4 | 11 | 3535 | 407,6 | 357 | 170 | 82 | 89 | 3,5 | | | | 26,50 | |
| | 91304005 | 5 | 12 | 3535 | 407,6 | 357 | 170 | 101 | | | 6 | 89 | | 30,20 | |
| | 91304006 | 6 | 12 | 3535 | 407,6 | 357 | 170 | 120 | | | 15,5 | 89 | | 31,80 | |
| | 91304008 | 8 | 9 | 4040 | 407,6 | 357 | 200 | 158 | | | | 28 | 102 | | 43,00 |
| 450 | 91304502 | 2 | 11 | 3020 | 457,6 | 407 | 150 | 44 | 51 | 3,5 | | | | 19,00 | |
| | 91304503 | 3 | 13 | 3535 | 457,6 | 407 | 170 | 63 | 89 | 26 | | | | 26,30 | |
| | 91304504 | 4 | 13 | 3535 | 457,6 | 407 | 170 | 82 | 89 | 7 | | | | 27,20 | |
| | 91304505 | 5 | 16 | 3535 | 457,6 | 407 | 170 | 101 | | | 12 | 89 | | 32,80 | |
| | 91304506 | 6 | 16 | 4040 | 457,6 | 407 | 200 | 120 | | | 18 | 102 | | 35,30 | |
| | 91304508 | 8 | 12 | 4040 | 457,6 | 407 | 200 | 158 | | | 28 | 102 | | 46,00 | |
| 500 | 91305002 | 2 | 11 | 3020 | 507,6 | 457 | 150 | 44 | 51 | 3,5 | | | | 21,00 | |
| | 91305003 | 3 | 13 | 3535 | 507,6 | 457 | 170 | 63 | 89 | 26 | | | | 29,90 | |
| | 91305004 | 4 | 13 | 3535 | 507,6 | 457 | 170 | 82 | 89 | 7 | | | | 34,70 | |
| | 91305005 | 5 | 16 | 3535 | 507,6 | 457 | 170 | 101 | | | 12 | 89 | | 36,70 | |
| | 91305006 | 6 | 16 | 4040 | 507,6 | 457 | 200 | 120 | | | 18 | 102 | | 40,70 | |
| | 91305008 | 8 | 12 | 4040 | 507,6 | 457 | 200 | 158 | | | 28 | 102 | | 52,00 | |
| | 560 | 91305602 | 2 | 17 | 3030 | 567,6 | 517 | 150 | 44 | 76 | 28 | | | 4 | 24,00 |
| | | 91305603 | 3 | 13 | 3535 | 567,6 | 517 | 170 | 63 | 89 | 26 | | | | 37,20 |
| 91305604 | | 4 | 13 | 3535 | 567,6 | 517 | 170 | 82 | 89 | 7 | | | | 39,00 | |
| 91305605 | | 5 | 13 | 4040 | 567,6 | 517 | 200 | 101 | 102 | 1 | | | | 45,60 | |
| 91305606 | | 6 | 16 | 4040 | 567,6 | 517 | 200 | 120 | | | 18 | 102 | | 49,20 | |
| 91305608 | | 8 | 12 | 4545 | 567,6 | 517 | 225 | 158 | | | 22 | 114 | | 54,50 | |
| 630 | 91306303 | 3 | 13 | 3535 | 637,6 | 587 | 170 | 63 | 89 | 26 | | | | 41,00 | |
| | 91306304 | 4 | 13 | 3535 | 637,6 | 587 | 170 | 82 | 89 | 7 | | | | 44,50 | |
| | 91306305 | 5 | 13 | 4040 | 637,6 | 587 | 200 | 101 | 102 | 1 | | | | 50,00 | |
| | 91306306 | 6 | 16 | 4040 | 637,6 | 587 | 200 | 120 | | | 18 | 102 | | 53,50 | |
| | 91306308 | 8 | 12 | 4545 | 637,6 | 587 | 225 | 158 | | | 22 | 114 | | 67,00 | |
| | 710 | 91307103 | 3 | 17 | 3535 | 717,6 | 664 | 170 | 63 | 89 | 22 | | | 4 | 48,00 |
| 91307104 | | 4 | 11 | 3535 | 717,6 | 664 | 170 | 82 | 89 | 3,5 | | | | 50,50 | |
| 91307105 | | 5 | 11 | 4040 | 717,6 | 664 | 200 | 101 | 102 | 0,5 | | | | 63,50 | |
| 91307106 | | 6 | 12 | 4545 | 717,6 | 664 | 225 | 120 | | | 3 | 114 | | 69,00 | |
| 91307108 | | 8 | 12 | 4545 | 717,6 | 664 | 225 | 158 | | | 22 | 114 | | 75,50 | |
| 91307010 | | 10 | 12 | 4545 | 717,6 | 664 | 225 | 196 | | | 41 | 114 | | 82,00 | |

MATERIAL CAST-IRON

CAD drawings available on our site
www.chiaravalli.com

Quantity, availability and prices
 on B2B Chiaravalli

www.bibiscom.ro



V-BELT PULLEYS for TAPER BUSHES

17

TAPER BUSHES

SPB TYPE

We are engaged to respect shapes and dimensions shown on this sheet but, we reserve the right to make changes and modifications without notice.

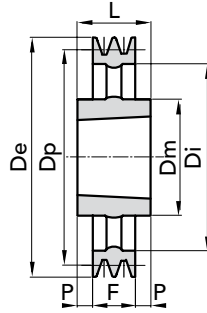

EXEC. 11

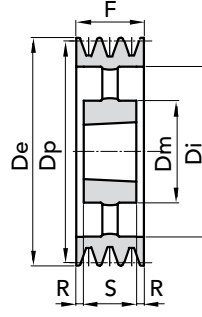

EXEC. 12

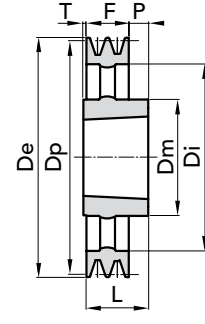

EXEC. 17

| Dp | P. NUMBER | N° | EXEC. | BUSHE | Ø De | Ø Di | Ø Dm | F | L | P | R | S | T | WEIGHT |
|---------|-----------|----|-------|-------|--------|------|------|-----|-----|-----|------|------|-----|--------|
| GROOVES | | | | | | | | | | | | | | Kg. |
| 800 | 91308003 | 3 | 17 | 3535 | 807,6 | 754 | 170 | 63 | 89 | 22 | | | 4 | 55,00 |
| | 91308004 | 4 | 17 | 4040 | 807,6 | 754 | 200 | 82 | 102 | 16 | | | 4 | 60,50 |
| | 91308005 | 5 | 11 | 4040 | 807,6 | 754 | 200 | 101 | 102 | 5 | | | | 67,00 |
| | 91308006 | 6 | 12 | 4545 | 807,6 | 754 | 225 | 120 | | | 3 | 114 | | 84,50 |
| | 91308008 | 8 | 12 | 4545 | 807,6 | 754 | 225 | 158 | | | 22 | 114 | | 94,50 |
| | 91308010 | 10 | 12 | 4545 | 807,6 | 754 | 225 | 196 | | | | 41 | 114 | |
| 900 | 91309003 | 3 | 17 | 3535 | 907,6 | 854 | 170 | 63 | 89 | 22 | | | 4 | 64,10 |
| | 91309004 | 4 | 17 | 4040 | 907,6 | 854 | 200 | 82 | 102 | 16 | | | 4 | 70,00 |
| 1000 | 91310003 | 3 | 17 | 4040 | 1007,6 | 954 | 200 | 63 | 102 | 33 | | | 6 | 72,00 |
| | 91310004 | 4 | 17 | 4040 | 1007,6 | 954 | 200 | 82 | 102 | 16 | | | 4 | 77,50 |
| | 91310005 | 5 | 11 | 4545 | 1007,6 | 954 | 225 | 101 | 114 | 6,5 | | | | 110,0 |
| | 91310006 | 6 | 12 | 4545 | 1007,6 | 954 | 225 | 120 | | | 2 | 114 | | 114,0 |
| | 91310008 | 8 | 12 | 5050 | 1007,6 | 954 | 245 | 158 | | | 15,5 | 127 | | 121,5 |
| | 91310010 | 10 | 12 | 5050 | 1007,6 | 954 | 245 | 196 | | | | 34,5 | 127 | |
| 1250 | 91312503 | 3 | 17 | 4040 | 1257,6 | 1204 | 200 | 63 | 102 | 33 | | | 6 | 140,0 |
| | 91312504 | 4 | 17 | 4545 | 1257,6 | 1204 | 225 | 82 | 114 | 26 | | | 6 | 162,0 |
| | 91312505 | 5 | 11 | 4545 | 1257,6 | 1204 | 225 | 101 | 114 | 6,5 | | | | 180,0 |
| | 91312506 | 6 | 11 | 5050 | 1257,6 | 1204 | 245 | 120 | 127 | 3,5 | | | | 210,0 |
| | 91312508 | 8 | 12 | 5050 | 1257,6 | 1204 | 245 | 158 | | | 15,5 | 127 | | 242,0 |
| | 91312510 | 10 | 12 | 5050 | 1257,6 | 1204 | 245 | 196 | | | | 34,5 | 127 | |

V-BELT PULLEYS for TAPER BUSHES

MATERIAL CAST-IRON

CAD drawings available on our site
www.chiaravalli.com

Quantity, availability and prices
 on B2B Chiaravalli

www.bibiscom.ro

V-BELT PULLEYS for TAPER BUSHES



TAPER BUSHES

SPC TYPE

We are engaged to respect shapes and dimensions shown on this sheet but, we reserve the right to make changes and modifications without notice.

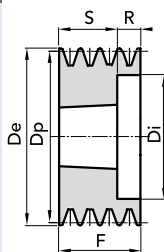

EXEC. 6

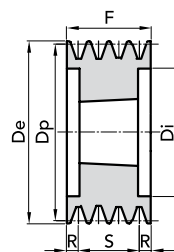

EXEC. 7

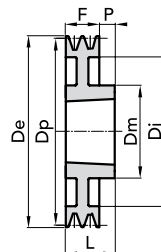

EXEC. 8

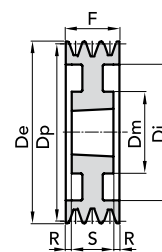

EXEC. 9

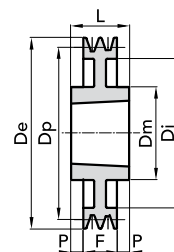

EXEC. 10

| Dp | P. NUMBER | N° | EXEC. | BUSHE | Ø De | Ø Di | Ø Dm | F | L | P | R | S | WEIGHT Kg. | |
|----------------|-----------|----------|-------|-------|-------|-------|------|-------|-------|----|-------|-------|---------------|-------|
| GROOVES | | | | | | | | | | | | | | |
| 180 | 91401803 | 3 | 7 | 2517 | 190,2 | 128 | | 85 | | | 20 | 45 | 9,20 | |
| | 91401804 | 4 | 7 | 2517 | 190,2 | 124 | | 110,5 | | | 32,75 | 45 | 11,50 | |
| | 91401805 | 5 | 7 | 3020 | 190,2 | 124 | | 136 | | | 42,5 | 51 | 13,70 | |
| | 91401806 | 6 | 7 | 3020 | 190,2 | 124 | | 161,5 | | | 55,25 | 51 | 16,50 | |
| 200 | 91402002 | 2 | 6 | 2517 | 210,2 | 144 | | 59,5 | | | 14,5 | 45 | 10,00 | |
| | 91402003 | 3 | 7 | 2517 | 210,2 | 144 | | 85 | | | 17 | 51 | 10,20 | |
| | 91402004 | 4 | 7 | 3020 | 210,2 | 144 | | 110,5 | | | 10,75 | 89 | 11,30 | |
| | 91402005 | 5 | 7 | 3535 | 210,2 | 144 | | 136 | | | 23,5 | 89 | 12,20 | |
| | 91402006 | 6 | 7 | 3535 | 210,2 | 144 | | 161,5 | | | 36,25 | 89 | 14,10 | |
| | 91402008 | 8 | 7 | 3535 | 210,2 | 144 | | 212,5 | | | 61,75 | 89 | 20,00 | |
| | 224 | 91402242 | 2 | 6 | 3020 | 234,2 | 173 | | 59,5 | | | 8,5 | 51 | 11,00 |
| 91402243 | | 3 | 7 | 3020 | 234,2 | 173 | | 85 | | | 17 | 51 | 12,70 | |
| 91402244 | | 4 | 7 | 3535 | 234,2 | 173 | | 110,5 | | | 10,75 | 89 | 14,50 | |
| 91402245 | | 5 | 7 | 3535 | 234,2 | 173 | | 136 | | | 23,5 | 89 | 16,60 | |
| 91402246 | | 6 | 7 | 3535 | 234,2 | 173 | | 161,5 | | | 36,25 | 89 | 18,00 | |
| 91402248 | | 8 | 7 | 3535 | 234,2 | 170 | | 212,5 | | | 61,75 | 89 | 22,90 | |
| 91402210 | | 10 | 7 | 4040 | 234,2 | 170 | | 263,5 | | | 80,75 | 102 | 28,00 | |
| 236 | | 91402368 | 6 | 7 | 3535 | 246,2 | 180 | | 161,5 | | | 36,25 | 89 | 21,30 |
| 250 | | 91402502 | 2 | 6 | 3020 | 260,2 | 198 | | 59,5 | | | 8,5 | 51 | 15,00 |
| | | 91402503 | 3 | 7 | 3020 | 260,2 | 198 | | 85 | | | 17 | 51 | 16,50 |
| | 91402504 | 4 | 7 | 3535 | 260,2 | 198 | | 110,5 | | | 10,75 | 89 | 19,30 | |
| | 91402505 | 5 | 7 | 3535 | 260,2 | 198 | | 136 | | | 23,5 | 89 | 21,50 | |
| | 91402506 | 6 | 7 | 3535 | 260,2 | 198 | | 161,5 | | | 36,25 | 89 | 20,90 | |
| | 91402508 | 8 | 7 | 3535 | 260,2 | 198 | | 212,5 | | | 61,75 | 89 | 29,00 | |
| | 91402510 | 10 | 7 | 4040 | 260,2 | 198 | | 263,5 | | | 80,75 | 102 | 35,00 | |
| | 280 | 91402802 | 2 | 8 | 3535 | 290,2 | 228 | 170 | 59,5 | 89 | 29,5 | | | 18,00 |
| 91402803 | | 3 | 8 | 3535 | 290,2 | 228 | 170 | 85 | 89 | 4 | | | 22,70 | |
| 91402804 | | 4 | 7 | 3535 | 290,2 | 228 | | 110,5 | | | 10,75 | 89 | 25,40 | |
| 91402805 | | 5 | 7 | 3535 | 290,2 | 228 | | 136 | | | 23,5 | 89 | 28,40 | |
| 91402806 | | 6 | 7 | 3535 | 290,2 | 228 | | 161,5 | | | 36,25 | 89 | 31,50 | |
| 91402808 | | 8 | 7 | 3535 | 290,2 | 228 | | 212,5 | | | 61,75 | 89 | 36,10 | |
| 91402810 | | 10 | 7 | 4040 | 290,2 | 222 | | 263,5 | | | 80,75 | 102 | 42,10 | |
| 300 | | 91403002 | 2 | 8 | 3535 | 310,2 | 247 | 170 | 59,5 | 89 | 29,5 | | | 21,00 |
| | 91403003 | 3 | 10 | 3535 | 310,2 | 247 | 170 | 85 | 89 | 2 | | | 22,60 | |
| | 91403004 | 4 | 9 | 3535 | 310,2 | 247 | 170 | 110,5 | | | 10,75 | 89 | 25,00 | |
| | 91403005 | 5 | 9 | 3535 | 310,2 | 247 | 170 | 136 | | | 23,5 | 89 | 28,50 | |
| | 91403006 | 6 | 9 | 3535 | 310,2 | 247 | 170 | 161,5 | | | 36,25 | 89 | 31,50 | |
| | 91403008 | 8 | 7 | 4040 | 310,2 | 247 | 170 | 212,5 | | | 55,25 | 102 | 37,10 | |
| | 91403010 | 10 | 7 | 4545 | 310,2 | 242 | 170 | 263,5 | | | 74,75 | 114 | 44,10 | |
| | 315 | 91403152 | 2 | 8 | 3535 | 325,2 | 264 | 170 | 59,5 | 89 | 29,5 | | | 21,00 |
| | | 91403153 | 3 | 10 | 3535 | 325,2 | 264 | 170 | 85 | 89 | 2 | | | 22,00 |
| | | 91403154 | 4 | 9 | 3535 | 325,2 | 264 | 170 | 110,5 | | | 10,75 | 89 | 25,30 |
| 91403155 | | 5 | 9 | 3535 | 325,2 | 264 | 170 | 136 | | | 23,5 | 89 | 28,10 | |
| 91403156 | | 6 | 9 | 3535 | 325,2 | 264 | 170 | 161,5 | | | 36,25 | 89 | 33,20 | |
| 91403157 | | 8 | 7 | 4040 | 325,2 | 258 | 170 | 212,5 | | | 55,25 | 102 | 40,00 | |
| 91403158 | | 10 | 7 | 4545 | 325,2 | 258 | 170 | 263,5 | | | 74,75 | 114 | 47,00 | |

MATERIAL **CAST-IRON**

CAD drawings available on our site
www.chiaravalli.com

Quantity, availability and prices
 on B2B Chiaravalli

www.bibiscom.ro



V-BELT PULLEYS for TAPER BUSHES

TAPER BUSHES

SPC TYPE

We are engaged to respect shapes and dimensions shown on this sheet but, we reserve the right to make changes and modifications without notice.

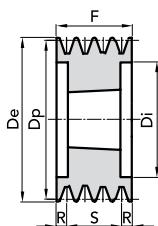

EXEC. 7

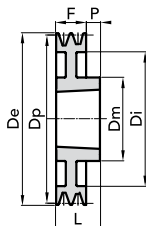

EXEC. 8

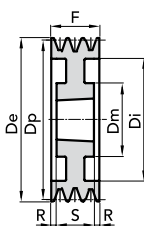

EXEC. 9

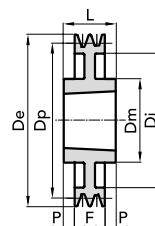

EXEC. 10

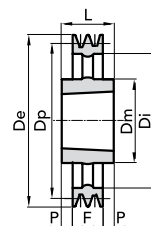

EXEC. 11

V-BELT PULLEYS for TAPER BUSHES

| Dp | P. NUMBER | N° | EXEC. | BUSHE | Ø De | Ø Di | Ø Dm | F | L | P | R | S | T | WEIGHT |
|----------|-----------|----------|-------|-------|-------|-------|------|-------|----|------|-------|-----|---|--------|
| GROOVES | | | | | | | | | | | | | | Kg. |
| 335 | 91403352 | 2 | 8 | 3535 | 345,2 | 279 | 170 | 59,5 | 89 | 29,5 | | | | 22,00 |
| | 91403353 | 3 | 10 | 3535 | 345,2 | 279 | 170 | 85 | 89 | 2 | | | | 24,10 |
| | 91403354 | 4 | 9 | 3535 | 345,2 | 279 | 170 | 110,5 | | | 10,75 | 89 | | 27,50 |
| | 91403355 | 5 | 9 | 3535 | 345,2 | 279 | 170 | 136 | | | 23,5 | 89 | | 31,00 |
| | 91403356 | 6 | 9 | 3535 | 345,2 | 279 | 170 | 161,5 | | | 36,25 | 89 | | 37,50 |
| | 91403358 | 8 | 9 | 4040 | 345,2 | 279 | 200 | 212,5 | | | 55,25 | 102 | | 44,00 |
| | 91403310 | 10 | 7 | 4545 | 345,2 | 279 | | 263,5 | | | 74,75 | 114 | | 51,00 |
| 355 | 91403552 | 2 | 8 | 3535 | 365,2 | 304 | 170 | 59,5 | 89 | 29,5 | | | | 23,00 |
| | 91403553 | 3 | 10 | 3535 | 365,2 | 304 | 170 | 85 | 89 | 2 | | | | 26,20 |
| | 91403554 | 4 | 9 | 3535 | 365,2 | 304 | 170 | 110,5 | | | 10,75 | 89 | | 29,30 |
| | 91403555 | 5 | 9 | 3535 | 365,2 | 304 | 170 | 136 | | | 23,5 | 89 | | 33,50 |
| | 91403556 | 6 | 9 | 3535 | 365,2 | 304 | 170 | 161,5 | | | 36,25 | 89 | | 40,50 |
| | 91403558 | 8 | 7 | 4040 | 365,2 | 304 | | 212,5 | | | 55,25 | 102 | | 49,00 |
| | 91403510 | 10 | 7 | 4545 | 365,2 | 299 | | 263,5 | | | 74,75 | 114 | | 57,00 |
| 400 | 91404002 | 2 | 17 | 3535 | 410,2 | 344 | 170 | 59,5 | 89 | 27,5 | | | 2 | 17,00 |
| | 91404003 | 3 | 11 | 3535 | 410,2 | 344 | 170 | 85 | 89 | 2 | | | | 29,30 |
| | 91404004 | 4 | 12 | 3535 | 410,2 | 344 | 170 | 110,5 | | | 10,75 | 89 | | 33,80 |
| | 91404005 | 5 | 12 | 3535 | 410,2 | 344 | 170 | 136 | | | 23,5 | 89 | | 38,50 |
| | 91404006 | 6 | 9 | 4040 | 410,2 | 344 | 200 | 161,5 | | | 29,75 | 102 | | 48,00 |
| | 91404008 | 8 | 9 | 4545 | 410,2 | 344 | 225 | 212,5 | | | 49,75 | 114 | | 58,00 |
| | 91404010 | 10 | 7 | 5050 | 410,2 | 342 | | 263,5 | | | 68,25 | 127 | | 66,00 |
| 450 | 91404502 | 2 | 17 | 3535 | 460,2 | 394 | 170 | 59,5 | 89 | 27,5 | | | 2 | 27,00 |
| | 91404503 | 3 | 11 | 3535 | 460,2 | 394 | 170 | 85 | 89 | 2 | | | | 34,70 |
| | 91404504 | 4 | 12 | 3535 | 460,2 | 394 | 170 | 110,5 | | | 10,75 | 89 | | 41,30 |
| | 91404505 | 5 | 12 | 4040 | 460,2 | 394 | 200 | 136 | | | 17 | 102 | | 45,30 |
| | 91404506 | 6 | 9 | 4545 | 460,2 | 394 | 225 | 161,5 | | | 23,75 | 114 | | 57,50 |
| | 91404508 | 8 | 9 | 5050 | 460,2 | 394 | 245 | 212,5 | | | 42,75 | 127 | | 70,00 |
| | 91404510 | 10 | 9 | 5050 | 460,2 | 394 | 245 | 263,5 | | | 68,25 | 127 | | 78,00 |
| 500 | 91405003 | 3 | 11 | 3535 | 510,2 | 444 | 170 | 85 | 89 | 2 | | | | 40,00 |
| | 91405004 | 4 | 12 | 3535 | 510,2 | 444 | 170 | 110,5 | | | 10,75 | 89 | | 46,00 |
| | 91405005 | 5 | 12 | 4040 | 510,2 | 444 | 200 | 136 | | | 17 | 102 | | 51,00 |
| | 91405006 | 6 | 12 | 4545 | 510,2 | 444 | 225 | 161,5 | | | 23,75 | 114 | | 67,00 |
| | 91405008 | 8 | 9 | 5050 | 510,2 | 444 | 245 | 212,5 | | | 42,75 | 127 | | 82,50 |
| | 91405010 | 10 | 9 | 5050 | 510,2 | 444 | 245 | 263,5 | | | 68,25 | 127 | | 95,50 |
| | 560 | 91405603 | 3 | 11 | 3535 | 570,2 | 504 | 170 | 85 | 89 | 2 | | | |
| 91405604 | | 4 | 12 | 4040 | 570,2 | 504 | 200 | 110,5 | | | 4,25 | 102 | | 58,00 |
| 91405605 | | 5 | 12 | 4545 | 570,2 | 504 | 225 | 136 | | | 11 | 114 | | 56,70 |
| 91405606 | | 6 | 12 | 5050 | 570,2 | 504 | 245 | 161,5 | | | 17,25 | 127 | | 77,50 |
| 91405608 | | 8 | 12 | 5050 | 570,2 | 504 | 245 | 212,5 | | | 42,75 | 127 | | 94,50 |
| 91405610 | | 10 | 9 | 5050 | 570,2 | 504 | 245 | 263,5 | | | 68,25 | 127 | | 94,70 |

MATERIAL CAST-IRON

EXEC. 12

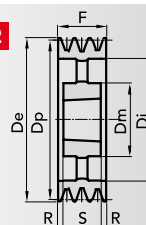

EXEC. 17

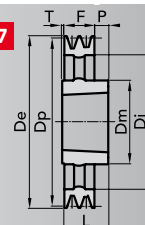

CAD drawings available on our site
www.chiaravalli.com

Quantity, availability and prices
 on B2B Chiaravalli

www.bibiscom.ro

V-BELT PULLEYS for TAPER BUSHES



TAPER BUSHES

SPC TYPE

We are engaged to respect shapes and dimensions shown on this sheet but, we reserve the right to make changes and modifications without notice.

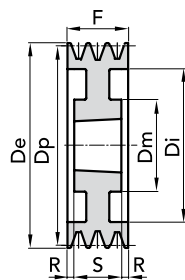

EXEC. 9

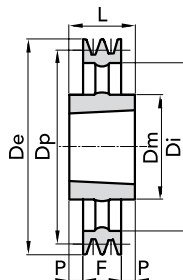

EXEC. 11

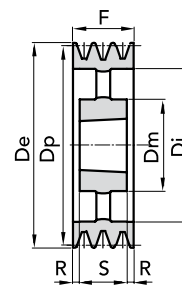

EXEC. 12

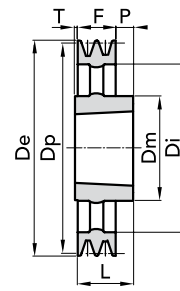

EXEC. 17

| Dp | P. NUMBER | N° | EXEC. | BUSHE | Ø De | Ø Di | Ø Dm | F | L | P | R | S | T | WEIGHT Kg. |
|----------------|-----------|----|-------|-------|--------|------|------|-------|-----|------|-------|-----|-----|---------------|
| GROOVES | | | | | | | | | | | | | | |
| 630 | 91406303 | 3 | 11 | 4040 | 640,2 | 574 | 200 | 85 | 102 | | | | | 76,30 |
| | 91406304 | 4 | 11 | 4545 | 640,2 | 574 | 225 | 110,5 | 114 | 1,75 | | | | 63,80 |
| | 91406305 | 5 | 12 | 5050 | 640,2 | 574 | 245 | 136 | | | 4,5 | 127 | | 73,00 |
| | 91406306 | 6 | 12 | 5050 | 640,2 | 574 | 245 | 161,5 | | | 17,25 | 127 | | 88,50 |
| | 91406308 | 8 | 12 | 5050 | 640,2 | 574 | 245 | 212,5 | | | 42,75 | 127 | | 102,0 |
| | 91406310 | 10 | 9 | 5050 | 640,2 | 574 | 245 | 263,5 | | | 68,25 | 127 | | 113,2 |
| 710 | 91407104 | 4 | 17 | 5050 | 720,2 | 654 | 267 | 110,5 | 127 | 12 | | | 4,5 | 83,20 |
| | 91407105 | 5 | 12 | 5050 | 720,2 | 654 | 245 | 136 | | | | | | 93,00 |
| | 91407106 | 6 | 12 | 5050 | 720,2 | 654 | 245 | 161,5 | | | | | | 107,3 |
| | 91407108 | 8 | 12 | 5050 | 720,2 | 654 | 245 | 212,5 | | | | | | 123,5 |
| | 91407110 | 10 | 12 | 5050 | 720,2 | 654 | 245 | 263,5 | | | | | | 133,4 |
| 800 | 91408003 | 3 | 17 | 5050 | 810,2 | 737 | 245 | 85 | 127 | 38 | | | 4 | 87,00 |
| | 91408004 | 4 | 17 | 5050 | 810,2 | 737 | 245 | 110,5 | 127 | 12 | | | 4,5 | 102,5 |
| | 91408005 | 5 | 12 | 5050 | 810,2 | 737 | 245 | 136 | | | 4,5 | 127 | | 119,0 |
| | 91408006 | 6 | 12 | 5050 | 810,2 | 737 | 245 | 161,5 | | | 17,5 | 127 | | 126,0 |
| | 91408008 | 8 | 12 | 5050 | 810,2 | 737 | 245 | 212,5 | | | 42,75 | 127 | | 145,0 |
| | 91408010 | 10 | 12 | 5050 | 810,2 | 737 | 245 | 263,5 | | | 68,25 | 127 | | 160,0 |
| 1000 | 91410003 | 3 | 17 | 5050 | 1010,2 | 937 | 245 | 85 | 127 | 38 | | | 4 | 120,0 |
| | 91410004 | 4 | 17 | 5050 | 1010,2 | 937 | 245 | 110,5 | 127 | 12 | | | 4,5 | 130,0 |
| | 91410005 | 5 | 12 | 5050 | 1010,2 | 937 | 245 | 136 | | | 4,5 | 127 | | 147,0 |
| | 91410006 | 6 | 12 | 5050 | 1010,2 | 937 | 245 | 161,5 | | | 17,5 | 127 | | 185,0 |
| | 91410008 | 8 | 12 | 5050 | 1010,2 | 937 | 245 | 212,5 | | | 42,75 | 127 | | 207,0 |
| | 91410010 | 10 | 12 | 5050 | 1010,2 | 937 | 245 | 263,5 | | | 68,25 | 127 | | 227,0 |
| 1250 | 91412503 | 3 | 17 | 5050 | 1260,2 | 1187 | 245 | 85 | 127 | 38 | | | 4 | 175,0 |
| | 91412504 | 4 | 17 | 5050 | 1260,2 | 1187 | 245 | 110,5 | 127 | 12 | | | 4,5 | 186,0 |
| | 91412505 | 5 | 12 | 5050 | 1260,2 | 1187 | 245 | 136 | | | 4,5 | 127 | | 210,0 |
| | 91412506 | 6 | 12 | 5050 | 1260,2 | 1187 | 245 | 161,5 | | | 17,5 | 127 | | 258,0 |
| | 91412508 | 8 | 12 | 5050 | 1260,2 | 1187 | 245 | 212,5 | | | 42,75 | 127 | | 285,0 |
| | 91412510 | 10 | 12 | 5050 | 1260,2 | 1187 | 245 | 263,5 | | | 68,25 | 127 | | 300,0 |

MATERIAL **CAST-IRON**

CAD drawings available on our site
www.chiaravalli.com

Quantity, availability and prices
 on B2B Chiaravalli

www.bibiscom.ro



CAST- IRON V-BELT PULLEYS



V-PULLEYS PILOT BORE



V-PULLEYS PILOT BORE

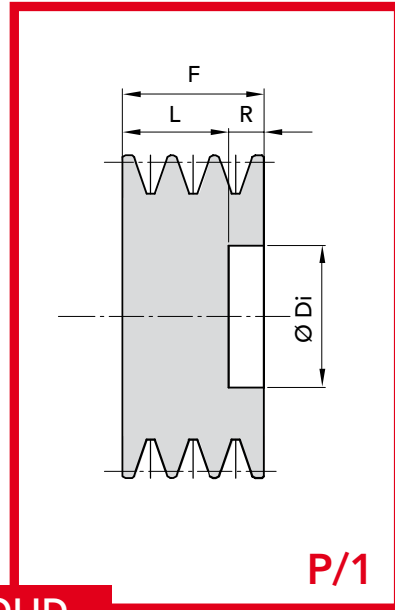
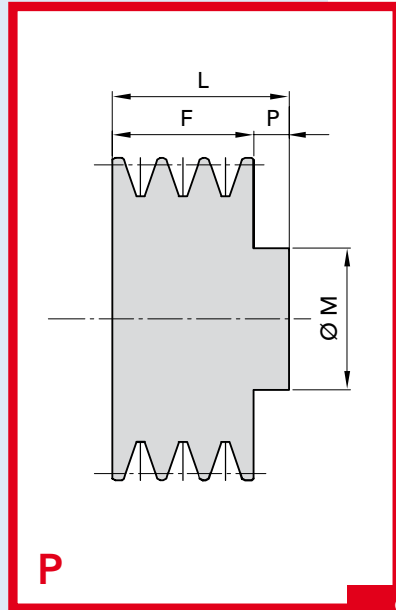

SOLID

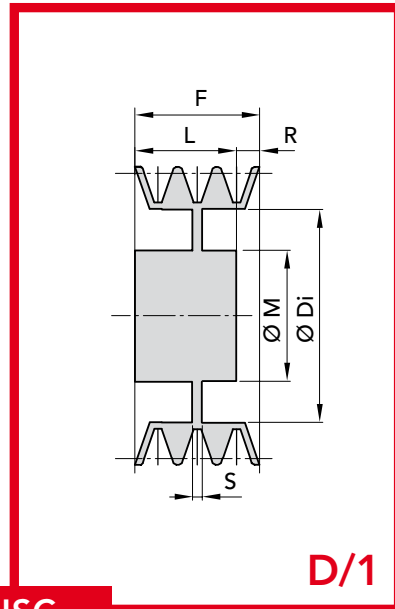
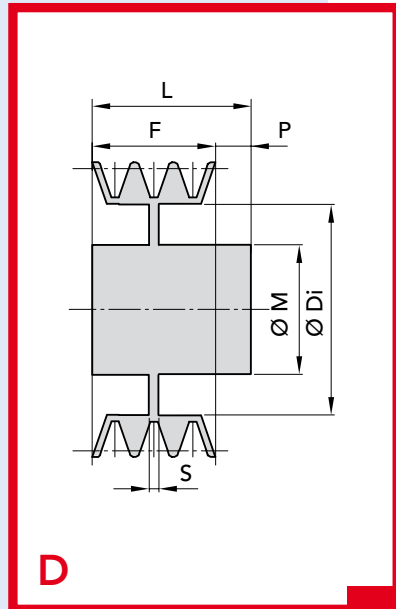

DISC

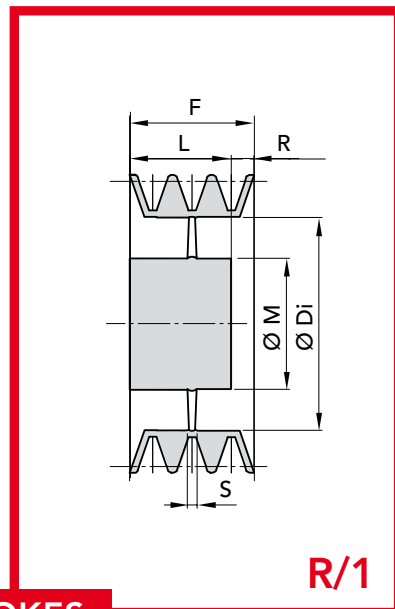
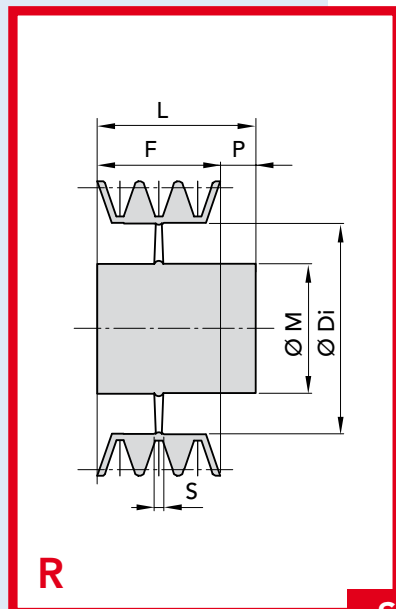

SPOKES



V-PULLEYS PILOT BORE

23

SOLID HUB

SPA TYPE

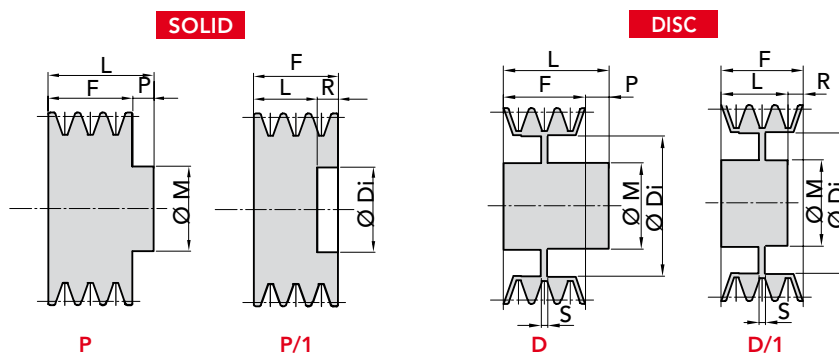

V-PULLEYS PILOT BORE

| Dp | P. NUMBER | N° | EXEC. | ØM | L | ØDi | S | F | P | R | WEIGHT |
|---------|-----------|----|-------|----|----|-----|----|----|---|---|--------|
| GROOVES | | | | | | | | | | | Kg. |
| | | | | | | | | | | | min |
| 40 | 91220401 | 1 | P | 40 | 35 | | 20 | 15 | | | 0,20 |
| 50 | 91220501 | 1 | P | 40 | 35 | | 20 | 15 | | | 0,30 |
| | 91220502 | 2 | P | 40 | 45 | | 35 | 10 | | | 0,40 |
| 55 | 91220551 | 1 | P | 40 | 35 | | 20 | 15 | | | 0,40 |
| | 91220552 | 2 | P | 40 | 45 | | 35 | 10 | | | 0,60 |
| 60 | 91220601 | 1 | P | 40 | 35 | | 20 | 15 | | | 0,40 |
| | 91220602 | 2 | P | 40 | 45 | | 35 | 10 | | | 0,65 |
| | 91220603 | 3 | P | 40 | 50 | | 50 | | | | 0,90 |
| 63 | 91220631 | 1 | P | 40 | 35 | | 20 | 20 | | | 0,50 |
| | 91220632 | 2 | P | 40 | 45 | | 35 | 10 | | | 0,70 |
| | 91220633 | 3 | P | 40 | 50 | | 50 | | | | 0,90 |
| 65 | 91220651 | 1 | P | 40 | 40 | | 20 | 20 | | | 0,50 |
| | 91220652 | 2 | P | 50 | 45 | | 35 | 10 | | | 0,75 |
| | 91220653 | 3 | P | 52 | 50 | | 50 | | | | 1,00 |
| 70 | 91220701 | 1 | P | 40 | 40 | | 20 | 20 | | | 0,50 |
| | 91220702 | 2 | P | 50 | 45 | | 35 | 10 | | | 0,80 |
| | 91220703 | 3 | P | 52 | 50 | | 50 | | | | 1,10 |
| | 91220704 | 4 | P | 52 | 65 | | 65 | | | | 1,40 |
| | 91220705 | 5 | P | 52 | 80 | | 80 | | | | 1,70 |
| 75 | 91220751 | 1 | P | 40 | 40 | | 20 | 20 | | | 0,50 |
| | 91220752 | 2 | P | 50 | 45 | | 35 | 10 | | | 1,10 |
| | 91220753 | 3 | P | 52 | 50 | | 50 | | | | 1,50 |
| | 91220754 | 4 | P | 52 | 65 | | 65 | | | | 2,00 |
| | 91220755 | 5 | P | 52 | 80 | | 80 | | | | 2,50 |
| 80 | 91220801 | 1 | P | 45 | 40 | | 20 | 20 | | | 0,50 |
| | 91220802 | 2 | P | 50 | 45 | | 35 | 10 | | | 1,00 |
| | 91220803 | 3 | P | 62 | 50 | | 50 | | | | 1,50 |
| | 91220804 | 4 | P | 62 | 65 | | 65 | | | | 2,00 |
| | 91220805 | 5 | P | 62 | 80 | | 80 | | | | 2,50 |
| 85 | 91220851 | 1 | P | 45 | 40 | | 20 | 20 | | | 0,60 |
| | 91220852 | 2 | P | 50 | 45 | | 35 | 10 | | | 1,20 |
| | 91220853 | 3 | P | 62 | 50 | | 50 | | | | 1,80 |
| | 91220854 | 4 | P | 62 | 65 | | 65 | | | | 2,40 |
| | 91220855 | 5 | P | 62 | 80 | | 80 | | | | 3,00 |
| 90 | 91220901 | 1 | P | 45 | 40 | | 20 | 20 | | | 0,80 |
| | 91220902 | 2 | P | 60 | 45 | | 35 | 10 | | | 1,40 |
| | 91220903 | 3 | P | 62 | 50 | | 50 | | | | 2,00 |
| | 91220904 | 4 | P | 68 | 65 | | 65 | | | | 2,60 |
| | 91220905 | 5 | P | 68 | 80 | | 80 | | | | 3,20 |

| Dp | P. NUMBER | N° | EXEC. | ØM | L | ØDi | S | F | P | R | WEIGHT |
|---------|-----------|----|-------|----|----|-----|----|----|----|---|--------|
| GROOVES | | | | | | | | | | | Kg. |
| | | | | | | | | | | | min |
| 95 | 91220951 | 1 | P | 45 | 40 | | 20 | 20 | | | 0,70 |
| | 91220952 | 2 | P | 60 | 45 | | 35 | 10 | | | 1,50 |
| | 91220953 | 3 | P | 62 | 50 | | 50 | | | | 2,30 |
| | 91220954 | 4 | P | 68 | 65 | | 65 | | | | 3,10 |
| | 91220955 | 5 | P | 68 | 80 | | 80 | | | | 3,90 |
| 100 | 91221001 | 1 | P | 48 | 40 | | 20 | 20 | | | 0,80 |
| | 91221002 | 2 | P | 60 | 45 | | 35 | 10 | | | 1,30 |
| | 91221003 | 3 | P | 62 | 50 | | 50 | | | | 1,80 |
| | 91221004 | 4 | P/1 | | 52 | 67 | 65 | | 13 | | 2,25 |
| | 91221005 | 5 | P/1 | | 52 | 67 | 80 | | 28 | | 2,10 |
| 105 | 91221051 | 1 | P | 48 | 40 | | 20 | 20 | | | 0,80 |
| | 91221052 | 2 | P | 60 | 45 | | 35 | 10 | | | 1,60 |
| | 91221053 | 3 | P | 62 | 50 | | 50 | | | | 2,40 |
| | 91221054 | 4 | P/1 | | 52 | 67 | 65 | | 13 | | 3,13 |
| | 91221055 | 5 | P/1 | | 52 | 67 | 80 | | 28 | | 3,30 |
| 112 | 91221121 | 1 | P | 48 | 40 | | 20 | 20 | | | 1,00 |
| | 91221122 | 2 | P | 60 | 45 | | 35 | 10 | | | 1,70 |
| | 91221123 | 3 | P | 62 | 50 | | 50 | | | | 2,40 |
| | 91221124 | 4 | P/1 | | 52 | 79 | 65 | | 13 | | 2,64 |
| | 91221125 | 5 | P/1 | | 52 | 79 | 80 | | 28 | | 2,80 |
| 120 | 91221201 | 1 | P | 60 | 40 | | 20 | 20 | | | 1,20 |
| | 91221202 | 2 | P | 60 | 50 | | 35 | 15 | | | 1,85 |
| | 91221203 | 3 | P | 70 | 50 | | 50 | | | | 2,40 |
| | 91221204 | 4 | P/1 | | 52 | 87 | 65 | | 13 | | 2,93 |
| | 91221205 | 5 | P/1 | | 52 | 87 | 80 | | 28 | | 3,70 |
| 125 | 91221251 | 1 | P | 60 | 40 | | 20 | 20 | | | 1,30 |
| | 91221252 | 2 | P | 60 | 50 | | 35 | 15 | | | 1,90 |
| | 91221253 | 3 | P | 70 | 50 | | 50 | | | | 2,50 |
| | 91221254 | 4 | P | | 50 | | 50 | | | | 3,10 |
| 130 | 91221301 | 1 | P | 60 | 45 | | 20 | 20 | | | 1,40 |
| | 91221302 | 2 | P | 60 | 45 | | 35 | 10 | | | 2,20 |
| | 91221303 | 3 | P | 70 | 52 | | 50 | | | | 3,00 |
| | 91221304 | 4 | P/1 | | 52 | 97 | 65 | | 13 | | 3,10 |
| | 91221305 | 5 | P/1 | | 52 | 97 | 80 | | 28 | | 2,80 |
| 140 | 91221401 | 1 | D | 60 | 40 | 107 | 10 | 20 | 20 | | 1,50 |
| | 91221402 | 2 | D | 60 | 50 | 107 | 10 | 35 | 15 | | 2,00 |
| | 91221403 | 3 | D | 70 | 52 | 107 | 12 | 50 | 2 | | 2,50 |
| | 91221404 | 4 | P/1 | | 52 | 107 | 65 | | 13 | | 2,70 |
| | 91221405 | 5 | P/1 | | 52 | 107 | 80 | | 28 | | 1,70 |
| 150 | 91221501 | 1 | D | 60 | 40 | 107 | 10 | 20 | 20 | | 1,60 |
| | 91221502 | 2 | D | 60 | 45 | 107 | 10 | 35 | 10 | | 2,50 |
| | 91221503 | 3 | D | 70 | 52 | 107 | 12 | 50 | 2 | | 3,60 |
| | 91221504 | 4 | P/1 | | 52 | 107 | 65 | | 13 | | 4,40 |
| | 91221505 | 5 | P/1 | | 52 | 107 | 80 | | 28 | | 4,00 |

MATERIAL CAST-IRON

CAD drawings available on our site
www.chiaravalli.com

Quantity, availability and prices
 on B2B Chiaravalli

www.bibiscom.ro

V-PULLEYS PILOT BORE



V-PULLEYS PILOT BORE

SOLID HUB

SPA TYPE

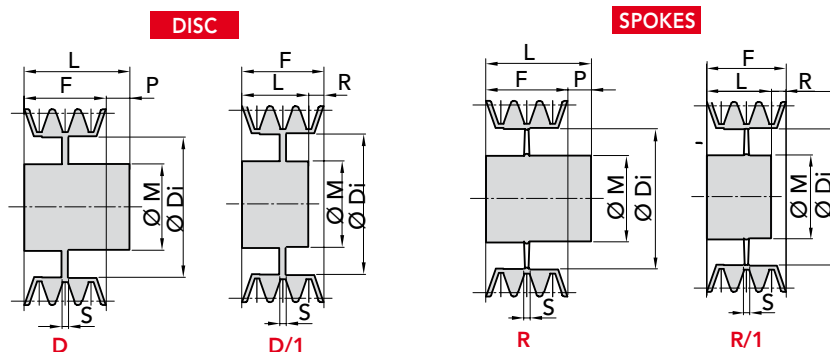

| Dp | P. NUMBER | N° | EXEC. | ØM | L | ØDi | S | F | P | R | WEIGHT | |
|-----|-----------|----|-------|---------|----|-----|----|----|----|----|--------|-----|
| | | | | GROOVES | | min | | | | | | Kg. |
| 160 | 91221601 | 1 | D | 60 | 40 | 127 | 10 | 20 | 20 | | 1,70 | |
| | 91221602 | 2 | D | 60 | 50 | 127 | 10 | 35 | 15 | | 2,40 | |
| | 91221603 | 3 | D | 70 | 52 | 127 | 12 | 50 | 2 | | 2,80 | |
| | 91221604 | 4 | D/1 | 70 | 52 | 127 | 18 | 65 | | 13 | 2,45 | |
| | 91221605 | 5 | D/1 | 80 | 52 | 127 | 18 | 80 | | 28 | 3,20 | |
| 170 | 91221701 | 1 | D | 60 | 40 | 137 | 12 | 20 | 20 | | 2,00 | |
| | 91221702 | 2 | D | 60 | 45 | 137 | 12 | 35 | 10 | | 2,90 | |
| | 91221703 | 3 | D | 70 | 52 | 137 | 12 | 50 | 2 | | 3,80 | |
| | 91221704 | 4 | D/1 | 80 | 52 | 137 | 18 | 65 | | 13 | 4,10 | |
| | 91221705 | 5 | D/1 | 80 | 52 | 137 | 18 | 80 | | 28 | 4,60 | |
| 180 | 91221801 | 1 | D | 65 | 40 | 147 | 12 | 20 | 20 | | 2,50 | |
| | 91221802 | 2 | D | 70 | 50 | 147 | 12 | 35 | 15 | | 3,10 | |
| | 91221803 | 3 | D | 70 | 52 | 147 | 12 | 50 | 2 | | 4,20 | |
| | 91221804 | 4 | D/1 | 80 | 60 | 147 | 18 | 65 | | 5 | 4,80 | |
| | 91221805 | 5 | D/1 | 80 | 65 | 147 | 18 | 80 | | 15 | 5,00 | |
| 190 | 91221902 | 2 | D | 70 | 50 | 157 | 12 | 35 | 15 | | 3,20 | |
| 200 | 91222001 | 1 | D | 65 | 45 | 167 | 12 | 20 | 25 | | 2,70 | |
| | 91222002 | 2 | D | 70 | 50 | 167 | 12 | 35 | 15 | | 3,70 | |
| | 91222003 | 3 | D | 70 | 50 | 167 | 12 | 50 | | 5 | 4,80 | |
| | 91222004 | 4 | D/1 | 80 | 60 | 167 | 18 | 65 | | 15 | 5,50 | |
| | 91222005 | 5 | D/1 | 80 | 65 | 167 | 18 | 80 | | | 5,80 | |
| 225 | 91222251 | 1 | D | 65 | 45 | 192 | 12 | 20 | 25 | | 3,00 | |
| | 91222252 | 2 | D | 70 | 50 | 192 | 12 | 35 | 15 | | 3,80 | |
| | 91222253 | 3 | D | 80 | 50 | 192 | 12 | 50 | | 5 | 5,00 | |
| | 91222254 | 4 | D/1 | 90 | 60 | 192 | 18 | 65 | | 15 | 5,60 | |
| | 91222255 | 5 | D/1 | 90 | 65 | 192 | 18 | 80 | | | 6,00 | |
| 250 | 91222501 | 1 | D | 75 | 50 | 217 | 12 | 20 | 30 | | 3,70 | |
| | 91222502 | 2 | D | 75 | 50 | 217 | 12 | 35 | 15 | | 4,30 | |
| | 91222503 | 3 | D | 80 | 60 | 217 | 12 | 50 | 10 | | 4,60 | |
| | 91222504 | 4 | D | 90 | 65 | 217 | 18 | 65 | | 15 | 6,10 | |
| | 91222505 | 5 | D/1 | 90 | 65 | 217 | 18 | 80 | | | 6,20 | |
| 280 | 91222801 | 1 | R | 75 | 50 | 247 | 14 | 20 | 30 | | 3,90 | |
| | 91222802 | 2 | R | 80 | 50 | 247 | 14 | 35 | 15 | | 5,30 | |
| | 91222803 | 3 | R | 80 | 60 | 247 | 14 | 50 | 10 | | 6,70 | |
| | 91222804 | 4 | R | 90 | 65 | 247 | 14 | 65 | | 15 | 8,10 | |
| | 91222805 | 5 | R/1 | 100 | 65 | 247 | 14 | 80 | | | 8,80 | |
| 300 | 91223001 | 1 | R | 75 | 50 | 267 | 14 | 20 | 30 | | 4,20 | |
| | 91223002 | 2 | R | 80 | 50 | 267 | 14 | 35 | 15 | | 5,90 | |
| | 91223003 | 3 | R | 80 | 60 | 267 | 14 | 50 | 10 | | 7,60 | |
| | 91223004 | 4 | R | 90 | 70 | 267 | 14 | 65 | 5 | 10 | 9,30 | |
| | 91223005 | 5 | R/1 | 100 | 70 | 267 | 14 | 80 | | | 10,3 | |
| 315 | 91223152 | 2 | R | 80 | 50 | 282 | 14 | 35 | 15 | | 6,60 | |

| Dp | P. NUMBER | N° | EXEC. | ØM | L | ØDi | S | F | P | R | WEIGHT | |
|-----|-----------|----|-------|---------|----|-----|----|----|----|----|--------|-----|
| | | | | GROOVES | | min | | | | | | Kg. |
| 355 | 91223551 | 1 | R | 75 | 50 | 322 | 14 | 20 | 30 | | 5,50 | |
| | 91223552 | 2 | R | 80 | 50 | 322 | 14 | 35 | 15 | | 7,70 | |
| | 91223553 | 3 | R | 90 | 60 | 322 | 14 | 50 | 10 | | 9,90 | |
| | 91223554 | 4 | R | 95 | 65 | 322 | 18 | 65 | | 15 | 12,10 | |
| | 91223555 | 5 | R/1 | 100 | 65 | 322 | 20 | 80 | | 15 | 13,45 | |
| 400 | 91224001 | 1 | R | 90 | 50 | 367 | 14 | 20 | 30 | | 6,80 | |
| | 91224002 | 2 | R | 90 | 50 | 367 | 14 | 35 | 15 | | 8,80 | |
| | 91224003 | 3 | R | 100 | 60 | 367 | 16 | 50 | 10 | | 11,0 | |
| | 91224004 | 4 | R | 100 | 65 | 367 | 20 | 65 | | | 13,2 | |
| | 91224005 | 5 | R/1 | 100 | 65 | 367 | 24 | 80 | | 15 | 14,5 | |
| 450 | 91224501 | 1 | R | 90 | 50 | 417 | 14 | 20 | 30 | | 7,50 | |
| | 91224502 | 2 | R | 100 | 50 | 417 | 14 | 35 | 15 | | 9,11 | |
| | 91224503 | 3 | R | 100 | 60 | 417 | 16 | 50 | 10 | | 11,30 | |
| | 91224504 | 4 | R/1 | 105 | 65 | 417 | 20 | 65 | | 5 | 12,90 | |
| | 91224505 | 5 | R/1 | 105 | 65 | 417 | 24 | 80 | | 15 | 14,25 | |
| 500 | 91225001 | 1 | R | 90 | 50 | 467 | 14 | 20 | 30 | | 10,50 | |
| | 91225002 | 2 | R | 100 | 50 | 467 | 16 | 35 | 15 | | 10,70 | |
| | 91225003 | 3 | R | 105 | 60 | 467 | 20 | 50 | 10 | | 10,90 | |
| | 91225004 | 4 | R/1 | 105 | 65 | 467 | 25 | 65 | | 5 | 10,80 | |
| | 91225005 | 5 | R/1 | 110 | 65 | 467 | 28 | 80 | | 15 | 11,00 | |
| 560 | 91225601 | 1 | R | 100 | 50 | 527 | 16 | 20 | 30 | | 12,00 | |
| | 91225602 | 2 | R | 100 | 50 | 527 | 20 | 35 | 15 | | 13,20 | |
| | 91225603 | 3 | R | 120 | 65 | 527 | 22 | 50 | 15 | | 13,40 | |
| | 91225604 | 4 | R | 120 | 65 | 527 | 25 | 65 | | | 13,70 | |
| | 91225605 | 5 | R | 120 | 80 | 527 | 30 | 80 | | | 14,00 | |
| 600 | 91226001 | 1 | R | 100 | 50 | 567 | 16 | 20 | 30 | | 14,70 | |
| | 91226002 | 2 | R | 110 | 50 | 567 | 20 | 35 | 15 | | 15,10 | |
| | 91226003 | 3 | R | 120 | 65 | 567 | 22 | 50 | 15 | | 18,80 | |
| | 91226004 | 4 | R | 120 | 65 | 567 | 25 | 65 | | | 22,50 | |
| | 91226005 | 5 | R | 120 | 80 | 567 | 30 | 80 | | | 26,20 | |
| 630 | 91226302 | 2 | R | 110 | 50 | 597 | 20 | 35 | 15 | | 15,40 | |
| | 91226303 | 3 | R | 120 | 65 | 597 | 22 | 50 | 15 | | 19,20 | |
| | 91226304 | 4 | R | 120 | 65 | 597 | 25 | 65 | | | 25,00 | |
| | 91226305 | 5 | R | 120 | 80 | 597 | 30 | 80 | | | 31,00 | |

MATERIAL CAST-IRON

CAD drawings available on our site
www.chiaravalli.comQuantity, availability and prices
on B2B Chiaravalliwww.bibiscom.ro

V-PULLEYS PILOT BORE



V-PULLEYS PILOT BORE

SOLID HUB

SPB TYPE

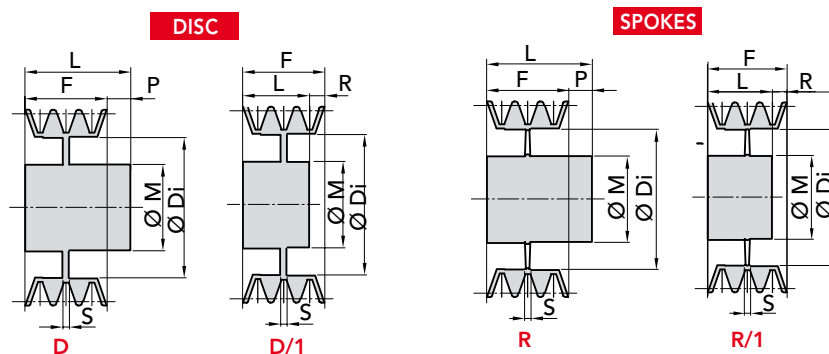

| Dp | P. NUMBER | N° | EXEC. | ØM | L | ØDi | S | F | P | R | WEIGHT | Dp | P. NUMBER | N° | EXEC. | ØM | L | ØDi | S | F | P | R | WEIGHT |
|---------|-----------|----|-------|-----|----|-----|----|-----|----|----|--------|---------|-----------|----|-------|-----|-----|-----|----|-----|----|----|--------|
| GROOVES | | | | | | | | | | | | GROOVES | | | | | | | | | | | |
| min | | | | | | | | | | | | min | | | | | | | | | | | |
| Kg. | | | | | | | | | | | | Kg. | | | | | | | | | | | |
| 200 | 91322001 | 1 | D | 70 | 45 | 158 | 14 | 25 | 20 | | 3,40 | 315 | 91323151 | 1 | R | 76 | 50 | 273 | 15 | 25 | 25 | | 6,40 |
| | 91322002 | 2 | D | 70 | 55 | 158 | 14 | 44 | 11 | | 4,40 | | 91323152 | 2 | R | 88 | 60 | 273 | 15 | 44 | 16 | | 8,20 |
| | 91322003 | 3 | D/1 | 88 | 60 | 158 | 18 | 63 | | 3 | 5,80 | | 91323153 | 3 | R/1 | 90 | 60 | 273 | 18 | 63 | | 3 | 14,0 |
| | 91322004 | 4 | D/1 | 88 | 60 | 158 | 25 | 82 | | 22 | 6,77 | | 91323154 | 4 | R/1 | 96 | 65 | 273 | 20 | 82 | | 17 | 17,0 |
| | 91322005 | 5 | D/1 | 96 | 70 | 158 | 25 | 101 | | 31 | 8,17 | | 91323155 | 5 | R/1 | 104 | 75 | 273 | 22 | 101 | | 26 | 19,0 |
| | 91322006 | 6 | D/1 | 96 | 80 | 158 | 25 | 120 | | 50 | 9,57 | | 91323156 | 6 | R/1 | 120 | 90 | 273 | 22 | 120 | | 30 | 24,0 |
| 212 | 91322121 | 1 | D | 70 | 45 | 170 | 14 | 25 | 20 | | 3,70 | 340 | 91323401 | 1 | R | 80 | 50 | 298 | 15 | 25 | 25 | | 6,70 |
| | 91322122 | 2 | D | 77 | 55 | 170 | 14 | 44 | 11 | | 4,60 | | 91323402 | 2 | R | 88 | 60 | 298 | 15 | 44 | 16 | | 12,5 |
| | 91322123 | 3 | D/1 | 88 | 60 | 170 | 18 | 63 | | 3 | 6,00 | | 91323403 | 3 | R/1 | 92 | 60 | 298 | 18 | 63 | | 3 | 15,0 |
| | 91322124 | 4 | D/1 | 88 | 60 | 170 | 25 | 82 | | 22 | 7,00 | | 91323404 | 4 | R/1 | 96 | 65 | 298 | 20 | 82 | | 17 | 19,0 |
| | 91322125 | 5 | D/1 | 96 | 70 | 170 | 25 | 101 | | 31 | 8,60 | | 91323405 | 5 | R/1 | 104 | 75 | 298 | 22 | 101 | | 26 | 20,0 |
| | 91322126 | 6 | D/1 | 104 | 80 | 170 | 25 | 120 | | 40 | 10,0 | | 91323406 | 6 | R/1 | 120 | 90 | 298 | 22 | 120 | | 30 | 28,0 |
| 224 | 91322244 | 4 | D/1 | 88 | 60 | 170 | 25 | 82 | | 22 | 3,85 | 355 | 91323551 | 1 | R | 80 | 50 | 313 | 16 | 25 | 25 | | 7,00 |
| 225 | 91322251 | 1 | D | 70 | 45 | 183 | 14 | 25 | 20 | | 4,00 | | 91323552 | 2 | R | 88 | 60 | 313 | 18 | 44 | 16 | | 13,0 |
| | 91322252 | 2 | D | 77 | 55 | 183 | 14 | 44 | 11 | | 5,40 | | 91323553 | 3 | R/1 | 92 | 60 | 313 | 22 | 63 | | 3 | 16,0 |
| | 91322253 | 3 | D/1 | 88 | 60 | 183 | 18 | 63 | | 3 | 6,90 | | 91323554 | 4 | R/1 | 96 | 65 | 313 | 22 | 82 | | 17 | 19,0 |
| | 91322254 | 4 | D/1 | 88 | 60 | 183 | 25 | 82 | | 22 | 7,83 | | 91323555 | 5 | R/1 | 104 | 75 | 313 | 24 | 101 | | 26 | 21,0 |
| | 91322255 | 5 | D/1 | 96 | 70 | 183 | 25 | 101 | | 31 | 9,33 | | 91323556 | 6 | R/1 | 120 | 90 | 313 | 24 | 120 | | 30 | 29,0 |
| | 91322256 | 6 | D/1 | 104 | 80 | 183 | 25 | 120 | | 40 | 10,83 | 380 | 91323801 | 1 | R | 85 | 55 | 338 | 20 | 25 | 30 | | 8,00 |
| 236 | 91322364 | 4 | D/1 | 88 | 60 | 170 | 25 | 82 | | 22 | 8,10 | | 91323802 | 2 | R | 88 | 60 | 338 | 20 | 44 | 16 | | 13,5 |
| 250 | 91322501 | 1 | D | 70 | 50 | 208 | 14 | 25 | 25 | | 4,20 | | 91323803 | 3 | R | 96 | 65 | 338 | 22 | 63 | 2 | | 17,0 |
| | 91322502 | 2 | D | 77 | 55 | 208 | 14 | 44 | 11 | | 6,10 | | 91323804 | 4 | R/1 | 104 | 75 | 338 | 24 | 82 | | 7 | 20,0 |
| | 91322503 | 3 | D/1 | 88 | 60 | 208 | 18 | 63 | | 3 | 8,60 | | 91323805 | 5 | R/1 | 112 | 85 | 338 | 24 | 101 | | 16 | 23,0 |
| | 91322504 | 4 | D/1 | 96 | 65 | 208 | 25 | 82 | | 17 | 10,36 | | 91323806 | 6 | R/1 | 120 | 100 | 338 | 28 | 120 | | 20 | 30,0 |
| | 91322505 | 5 | D/1 | 104 | 75 | 208 | 25 | 101 | | 26 | 12,86 | 400 | 91324001 | 1 | R | 85 | 55 | 358 | 20 | 25 | 30 | | 9,80 |
| | 91322506 | 6 | D/1 | 104 | 80 | 208 | 25 | 120 | | 40 | 15,36 | | 91324002 | 2 | R | 88 | 60 | 358 | 20 | 44 | 16 | | 14,0 |
| 280 | 91322801 | 1 | R | 76 | 50 | 238 | 14 | 25 | 25 | | 5,70 | | 91324003 | 3 | R | 96 | 65 | 358 | 22 | 63 | 2 | | 18,0 |
| | 91322802 | 2 | R | 80 | 55 | 238 | 14 | 44 | 11 | | 7,00 | | 91324004 | 4 | R/1 | 104 | 75 | 358 | 24 | 82 | | 7 | 21,0 |
| | 91322803 | 3 | R/1 | 90 | 60 | 238 | 18 | 63 | | 3 | 9,60 | | 91324005 | 5 | R/1 | 112 | 85 | 358 | 24 | 101 | | 16 | 24,0 |
| | 91322804 | 4 | R/1 | 96 | 65 | 238 | 25 | 82 | | 17 | 12,06 | | 91324006 | 6 | R/1 | 120 | 100 | 358 | 28 | 120 | | 20 | 32,0 |
| | 91322805 | 5 | R/1 | 104 | 75 | 238 | 25 | 101 | | 26 | 13,91 | 425 | 91324503 | 3 | R | 96 | 65 | 383 | 24 | 63 | 2 | | 19,0 |
| | 91322806 | 6 | R/1 | 104 | 80 | 238 | 25 | 120 | | 40 | 17,0 | | 91324504 | 4 | R/1 | 104 | 75 | 383 | 24 | 82 | | 7 | 22,0 |
| 300 | 91323001 | 1 | R | 76 | 50 | 258 | 15 | 25 | 25 | | 6,50 | | 91324505 | 5 | R/1 | 112 | 85 | 383 | 28 | 101 | | 16 | 26,0 |
| | 91323002 | 2 | R | 80 | 55 | 258 | 15 | 44 | 11 | | 7,50 | | 91324256 | 6 | R/1 | 120 | 100 | 358 | 28 | 120 | | 20 | 35,0 |
| | 91323003 | 3 | R/1 | 90 | 60 | 258 | 18 | 63 | | 3 | 12,0 | | | | | | | | | | | | |
| | 91323004 | 4 | R/1 | 96 | 65 | 258 | 20 | 82 | | 17 | 16,0 | | | | | | | | | | | | |
| | 91323005 | 5 | R/1 | 104 | 75 | 258 | 22 | 101 | | 26 | 19,0 | | | | | | | | | | | | |
| | 91323006 | 6 | R/1 | 104 | 80 | 258 | 22 | 120 | | 40 | 23,0 | | | | | | | | | | | | |

MATERIAL CAST-IRON

CAD drawings available on our site
www.chiaravalli.comQuantity, availability and prices
on B2B Chiaravalliwww.bibiscom.ro



V-PULLEYS PILOT BORE

27

SOLID HUB

SPB TYPE

SPOKES

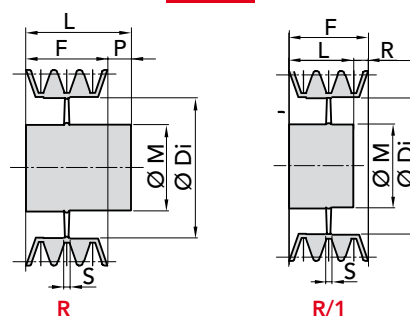

V-PULLEYS PILOT BORE

| Dp | P. NUMBER | N° | EXEC. | ØM | L | ØDi | S | F | P | R | WEIGHT |
|---------|-----------|----|-------|-----|-----|-----|-----|-----|----|----|--------|
| | | | | min | | | Kg. | | | | |
| GROOVES | | | | | | | | | | | |
| 450 | 91324501 | 1 | R | 90 | 60 | 408 | 20 | 25 | 35 | | 10,00 |
| | 91324502 | 2 | R | 90 | 60 | 408 | 20 | 44 | 16 | | 14,50 |
| | 91324503 | 3 | R | 96 | 65 | 408 | 24 | 63 | 2 | | 22,00 |
| | 91324504 | 4 | R/1 | 104 | 75 | 408 | 26 | 82 | | 7 | 25,00 |
| | 91324505 | 5 | R/1 | 112 | 85 | 408 | 26 | 101 | | 16 | 28,50 |
| | 91324506 | 6 | R/1 | 120 | 100 | 408 | 30 | 120 | | 20 | 36,00 |
| 500 | 91325001 | 1 | R | 100 | 60 | 458 | 20 | 25 | 35 | | 11,00 |
| | 91325002 | 2 | R | 100 | 65 | 458 | 20 | 44 | 21 | | 15,00 |
| | 91325003 | 3 | R | 104 | 75 | 458 | 24 | 63 | 12 | | 24,00 |
| | 91325004 | 4 | R | 112 | 85 | 458 | 26 | 82 | 3 | | 27,50 |
| | 91325005 | 5 | R/1 | 120 | 90 | 458 | 30 | 101 | | 11 | 31,00 |
| | 91325006 | 6 | R/1 | 129 | 105 | 458 | 30 | 120 | | 15 | 39,00 |
| 560 | 91325601 | 1 | R | 100 | 60 | 518 | 20 | 25 | 35 | | 15,00 |
| | 91325602 | 2 | R | 100 | 65 | 518 | 20 | 44 | 21 | | 17,00 |
| | 91325603 | 3 | R | 104 | 75 | 518 | 24 | 63 | 12 | | 29,50 |
| | 91325604 | 4 | R | 112 | 85 | 518 | 26 | 82 | 3 | | 34,00 |
| | 91325605 | 5 | R/1 | 120 | 90 | 518 | 30 | 101 | | 11 | 36,00 |
| | 91325606 | 6 | R/1 | 128 | 105 | 518 | 35 | 120 | | 15 | 48,00 |
| 600 | 91326001 | 1 | R | 100 | 60 | 558 | 22 | 25 | 35 | | 16,00 |
| | 91326002 | 2 | R | 100 | 65 | 558 | 22 | 44 | 21 | | 18,00 |
| | 91326003 | 3 | R | 104 | 75 | 558 | 28 | 63 | 12 | | 31,00 |
| | 91326004 | 4 | R | 115 | 85 | 558 | 28 | 82 | 3 | | 35,00 |
| | 91326005 | 5 | R/1 | 120 | 90 | 558 | 30 | 101 | | 11 | 42,00 |
| | 91326006 | 6 | R/1 | 128 | 105 | 558 | 35 | 120 | | 15 | 49,00 |
| 630 | 91326301 | 1 | R | 100 | 60 | 588 | 22 | 25 | 35 | | 18,00 |
| | 91326302 | 2 | R | 100 | 65 | 588 | 28 | 44 | 21 | | 19,00 |
| | 91326303 | 3 | R | 104 | 75 | 588 | 28 | 63 | 12 | | 33,00 |
| | 91326304 | 4 | R | 120 | 85 | 588 | 32 | 82 | 3 | | 36,00 |
| | 91326305 | 5 | R/1 | 128 | 90 | 588 | 32 | 101 | | 11 | 48,00 |

MATERIAL **CAST-IRON**

CAD drawings available on our site
www.chiaravalli.com

Quantity, availability and prices
 on B2B Chiaravalli

www.bibiscom.ro

V-PULLEYS PILOT BORE



V-PULLEYS PILOT BORE

SOLID HUB

SPC TYPE

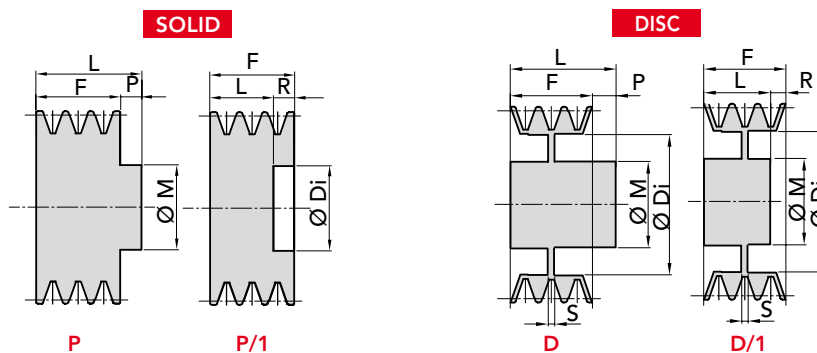

| Dp | P. NUMBER | N° | EXEC. | ØM | L | ØDi | S | F | P | R | WEIGHT |
|---------|-----------|----|-------|-----|------|-----|----|------|------|---|--------|
| GROOVES | | | | | | | | | | | |
| min | | | | | | | | | | | |
| Kg. | | | | | | | | | | | |
| 120 | 91421201 | 1 | P | 65 | 50 | | | 34 | 16 | | 2,30 |
| | 91421202 | 2 | P | 65 | 65 | | | 59,5 | 5,5 | | 2,60 |
| 140 | 91421401 | 1 | P | 70 | 55 | | | 34 | 21 | | 2,10 |
| | 91421402 | 2 | P | | 59,5 | | | 59,5 | | | 2,90 |
| | 91421403 | 3 | P/1 | | 65 | 83 | | 85 | 20 | | 3,90 |
| | 91421404 | 4 | P/1 | | 80 | 83 | | 111 | 30,5 | | 4,74 |
| 150 | 91421501 | 1 | P | 70 | 50 | | | 34 | 16 | | 3,10 |
| | 91421502 | 2 | P | 72 | 59,5 | | | 59,5 | | | 3,90 |
| | 91421503 | 3 | P/1 | | 65 | 93 | | 85 | 20 | | 4,70 |
| | 91421504 | 4 | P/1 | | 80 | 93 | | 111 | 30,5 | | 5,70 |
| | 91421505 | 5 | P/1 | | 96 | 93 | | 136 | 40 | | 6,70 |
| 160 | 91421601 | 1 | P | 72 | 50 | | | 34 | 16 | | 3,70 |
| | 91421602 | 2 | P | | 59,5 | | | 59,5 | | | 4,60 |
| | 91421603 | 3 | P/1 | | 65 | 103 | | 85 | 20 | | 5,70 |
| | 91421604 | 4 | P/1 | | 80 | 103 | | 111 | 30,5 | | 7,00 |
| | 91421605 | 5 | P/1 | | 96 | 103 | | 136 | 40 | | 8,30 |
| 180 | 91421801 | 1 | D | 76 | 50 | 123 | 16 | 34 | 16 | | 3,10 |
| | 91421802 | 2 | D | 80 | 60 | 123 | 16 | 59,5 | 0,5 | | 3,90 |
| | 91421803 | 3 | D/1 | 82 | 65 | 123 | 18 | 85 | 20 | | 5,20 |
| | 91421804 | 4 | D/1 | 82 | 80 | 123 | 20 | 111 | 30,5 | | 6,18 |
| | 91421805 | 5 | D/1 | 82 | 96 | 123 | 20 | 136 | 40 | | 7,48 |
| 200 | 91422001 | 1 | D | 76 | 50 | 143 | 16 | 34 | 16 | | 3,40 |
| | 91422002 | 2 | D | 80 | 60 | 143 | 16 | 59,5 | 0,5 | | 4,80 |
| | 91422003 | 3 | D/1 | 86 | 65 | 143 | 18 | 85 | 20 | | 5,80 |
| | 91422004 | 4 | D/1 | 90 | 90 | 143 | 25 | 111 | 20,5 | | 6,70 |
| | 91422005 | 5 | D/1 | 90 | 100 | 143 | 25 | 136 | 36 | | 8,70 |
| 225 | 91422251 | 1 | D | 86 | 50 | 168 | 18 | 34 | 16 | | 5,50 |
| | 91422252 | 2 | D | 88 | 60 | 168 | 18 | 59,5 | 0,5 | | 6,90 |
| | 91422253 | 3 | D/1 | 90 | 70 | 168 | 25 | 85 | 15 | | 7,83 |
| | 91422254 | 4 | D/1 | 90 | 90 | 168 | 25 | 111 | 20,5 | | 9,33 |
| | 91422255 | 5 | D/1 | 90 | 100 | 168 | 25 | 136 | 36 | | 10,83 |
| 250 | 91422501 | 1 | D | 86 | 50 | 193 | 18 | 34 | 16 | | 7,30 |
| | 91422502 | 2 | D | 92 | 60 | 193 | 18 | 59,5 | 0,5 | | 8,60 |
| | 91422503 | 3 | D/1 | 92 | 70 | 193 | 25 | 85 | 15 | | 10,36 |
| | 91422504 | 4 | D/1 | 100 | 90 | 193 | 25 | 111 | 20,5 | | 12,86 |
| | 91422505 | 5 | D/1 | 102 | 100 | 193 | 25 | 136 | 36 | | 15,36 |

MATERIAL CAST-IRON

CAD drawings available on our site
www.chiaravalli.com

Quantity, availability and prices
 on B2B Chiaravalli

www.bibiscom.ro



V-BELT PULLEYS for LOCKING DEVICES

V-BELT PULLEYS for LOCKING DEVICES

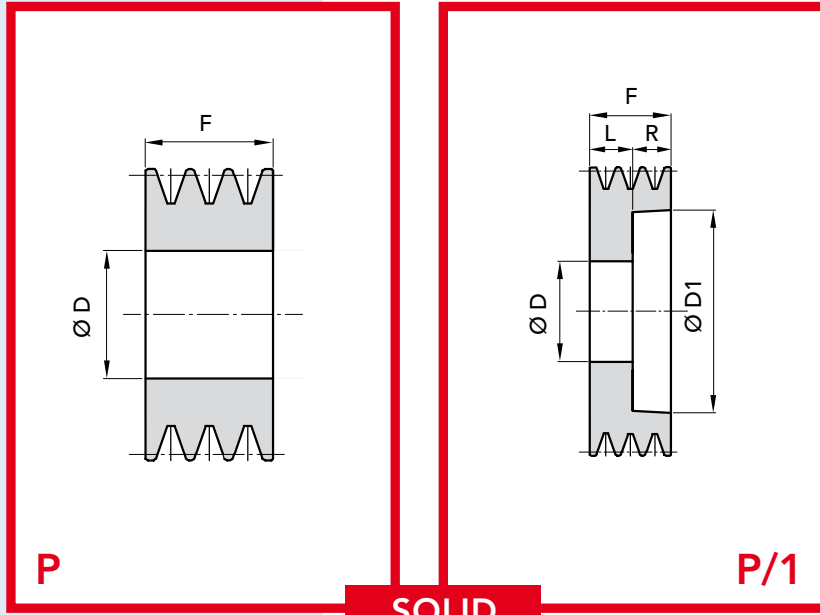

P

P/1

SOLID

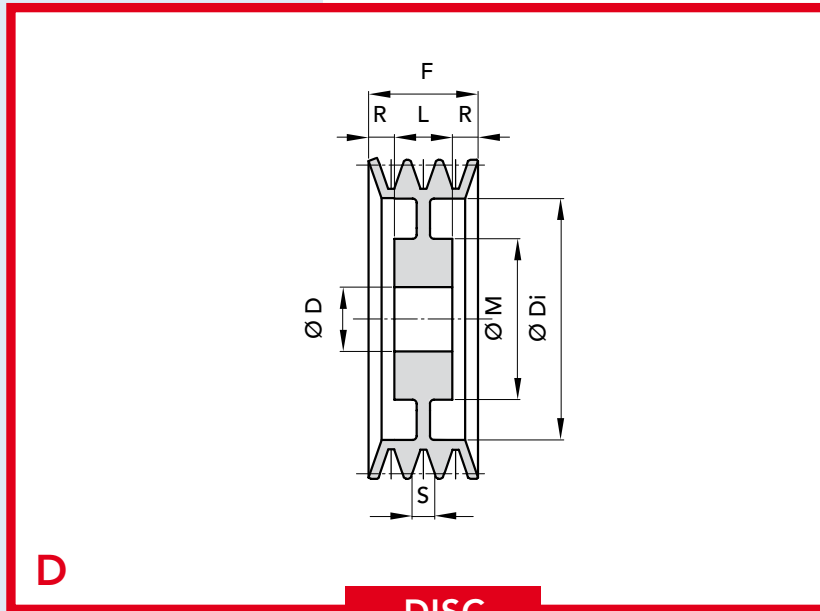

D

DISC

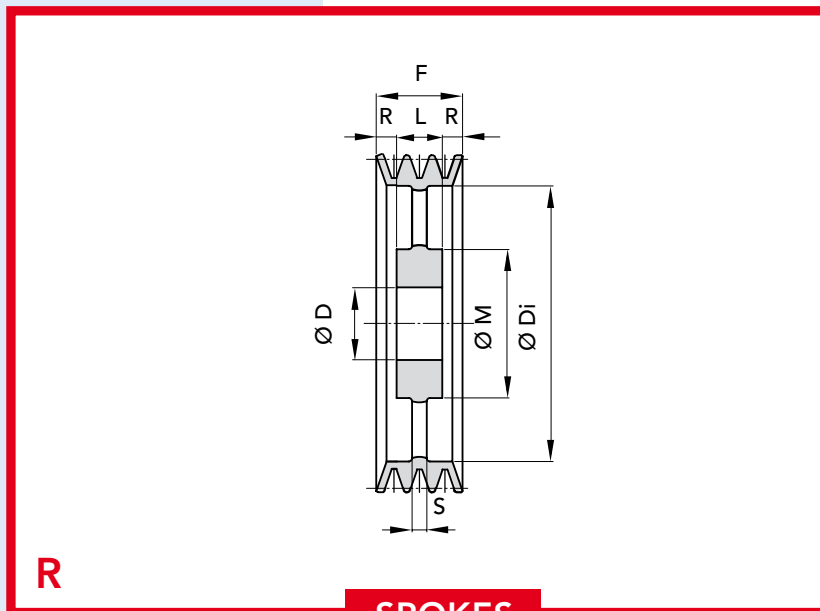

R

SPOKES

V-BELT PULLEYS for LOCKING DEVICES

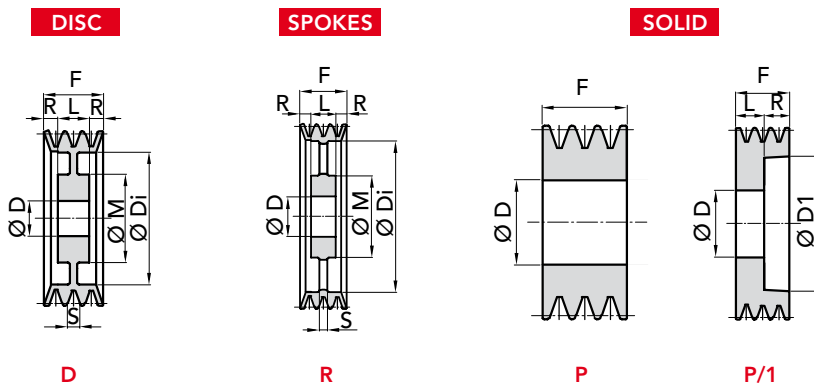
V-BELT PULLEYS for LOCKING DEVICES SPA
for LOCKING DEVICES
SPA TYPE

| Dp | P. NUMBER Ø 55 H8 | P. NUMBER Ø 65 H8 | P. NUMBER Ø 80 H8 | N° GROOVES | EXEC. | F | L | Ø M | R | Ø Di | S | WEIGHT Kg. |
|-----|----------------------|----------------------|----------------------|---------------|-------|----|----|-----|------|------|----|---------------|
| 90 | 91250902 | | | 2 | P | 35 | | | | | | 0,20 |
| | 91250903 | | | 3 | P | 50 | | | | | | 1,10 |
| | 91250905 | | | 5 | P | 80 | | | | | | 2,00 |
| 95 | 91250952 | | | 2 | P | 35 | | | | | | 0,85 |
| 100 | 91251001 | | | 1 | P | 20 | | | | | | 0,50 |
| | 91251002 | 91261002 | | 2 | P | 35 | | | | | | 0,90 |
| | 91251003 | | | 3 | P | 50 | | | | | | 1,30 |
| 105 | 91251052 | | | 2 | P | 35 | | | | | | 0,95 |
| 120 | 91251202 | | | 2 | P/1 | 35 | 27 | | 8 | 88 | | 1,00 |
| 125 | | 91261252 | | 2 | P/1 | 35 | 27 | | 8 | 92 | | 1,00 |
| | | 91261253 | | 3 | P/1 | 50 | 27 | | 23 | 92 | | 1,80 |
| | | 91261254 | | 4 | P/1 | 65 | 27 | | 38 | 92 | | 2,40 |
| 130 | | 91261303 | | 3 | P/1 | 50 | 27 | | 23 | 97 | | 1,75 |
| 140 | | 91261403 | | 4 | P/1 | 65 | 27 | | 38 | 107 | | 1,50 |
| 150 | 91251502 | | | 2 | P/1 | 35 | 27 | | 8 | 117 | | 1,35 |
| | | 91261504 | | 4 | P/1 | 65 | 27 | | 38 | 117 | | 2,15 |
| 160 | 91251602 | 91261602 | | 2 | P/1 | 35 | 27 | | 8 | 127 | | 1,50 |
| | | 91261603 | | 3 | P/1 | 50 | 27 | | 23 | 127 | | 1,90 |
| 170 | 91251702 | | | 2 | D | 35 | 27 | | 4 | 137 | 27 | 1,60 |
| 180 | 91251802 | 91261802 | | 2 | D | 35 | 27 | | 4 | 147 | 27 | 1,70 |
| | 91251803 | 91271803 | | 3 | D | 50 | 27 | | 11,5 | 147 | 27 | 2,40 |
| 190 | | 91261902 | | 2 | D | 35 | 27 | 120 | 4 | 157 | 12 | 1,80 |
| | | 91261903 | | 3 | D | 50 | 27 | 120 | 11,5 | 157 | 12 | 2,50 |
| 200 | 91252002 | 91262002 | | 2 | D | 35 | 27 | 120 | 4 | 167 | 12 | 1,90 |
| | | 91262003 | | 3 | D | 50 | 27 | 120 | 11,5 | 167 | 14 | 2,60 |
| | | 91262004 | | 4 | D | 65 | 27 | 120 | 19 | 167 | 14 | 3,30 |
| 225 | 91252252 | 91262252 | | 2 | D | 35 | 27 | 120 | 4 | 192 | 12 | 2,20 |
| | | 91262253 | | 3 | D | 50 | 27 | 120 | 11,5 | 192 | 14 | 2,80 |
| 250 | 91252502 | | | 2 | R | 35 | 27 | 130 | 4 | 217 | 14 | 2,80 |
| | | | 91282503 | 3 | R | 50 | 27 | 130 | 11,5 | 217 | 14 | 3,50 |
| | | 91262504 | | 4 | R | 65 | 27 | 130 | 19 | 217 | 14 | 4,20 |
| 300 | | | 91283004 | 4 | R | 65 | 27 | 130 | 19 | 267 | 14 | 3,40 |

MATERIAL CAST-IRON

 CAD drawings available on our site
www.chiaravalli.com

 Quantity, availability and prices
 on B2B Chiaravalli

www.bibiscom.ro



V-BELT PULLEYS for LOCKING DEVICES

31

for LOCKING DEVICES

SPB TYPE

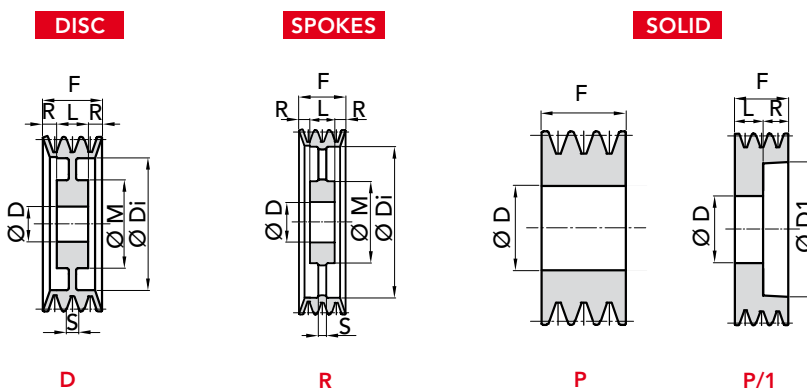

| Dp | P. NUMBER Ø 55 H8 | P. NUMBER Ø 65 H8 | P. NUMBER Ø 80 H8 | N° GROOVES | EXEC. | F | L | Ø M | R | Ø Di | S | WEIGHT Kg. |
|-----|----------------------|----------------------|----------------------|---------------|-------|-----|----|-----|------|------|----|---------------|
| 112 | 91351121 | | | 1 | P | 25 | | | | | | 1,50 |
| | 91351122 | | | 2 | P/1 | 44 | 27 | | 17 | 70 | | 1,90 |
| 120 | | 91361202 | | 2 | P/1 | 44 | 27 | | 17 | 78 | | 2,10 |
| | | 91361203 | | 3 | P/1 | 63 | 27 | | 36 | 78 | | 3,80 |
| | | 91361204 | | 4 | P/1 | 82 | 27 | | 55 | 78 | | 4,20 |
| 125 | 91351251 | | | 1 | P | 25 | | | | | | 1,90 |
| | | 91371252 | | 2 | P/1 | 44 | 27 | | 17 | 83 | | 2,40 |
| | | 91361253 | | 3 | P/1 | 63 | 27 | | 36 | 83 | | 4,00 |
| 130 | | 91361302 | 91381302 | 2 | P/1 | 44 | 27 | | 17 | 90 | | 2,60 |
| | | 91361303 | 91381303 | 3 | P/1 | 63 | 27 | | 36 | 90 | | 4,20 |
| | | 91361304 | 91381304 | 4 | P/1 | 82 | 27 | | 55 | 90 | | 5,00 |
| | | | 91381305 | 5 | P/1 | 101 | 27 | | 74 | 90 | | 5,50 |
| | | | 91381306 | 6 | P/1 | 120 | 27 | | 93 | 90 | | 6,00 |
| | | | | | | | | | | | | |
| 140 | 91351402 | 91361402 | 91381402 | 2 | P/1 | 44 | 27 | | 17 | 98 | | 2,90 |
| | | 91361403 | 91381403 | 3 | P/1 | 63 | 27 | | 36 | 98 | | 4,40 |
| | | 91361404 | 91381404 | 4 | P/1 | 82 | 27 | | 55 | 98 | | 5,30 |
| | | | 91381405 | 5 | P/1 | 101 | 27 | | 74 | 98 | | 5,80 |
| | | | | | | | | | | | | |
| 150 | 91351501 91351502 | 91361501 | | 1 | P | 25 | | | | | | 2,40 |
| | | 91361502 | 91381502 | 2 | P/1 | 44 | 27 | | 17 | 108 | | 3,20 |
| | | 91361503 | 91381503 | 3 | P/1 | 63 | 27 | | 36 | 108 | | 4,60 |
| | | 91361504 | 91381504 | 4 | P/1 | 82 | 27 | | 55 | 108 | | 5,50 |
| | | | 91381505 | 5 | P/1 | 101 | 27 | | 74 | 108 | | 6,00 |
| 160 | 91351601 | 91361601 | | 1 | P | 25 | | | | | | 2,50 |
| | | 91361602 | 91381602 | 2 | P/1 | 44 | 27 | | 17 | 118 | | 3,30 |
| | | 91361603 | 91381603 | 3 | P/1 | 63 | 27 | | 36 | 118 | | 4,80 |
| | | | 91381604 | 4 | P/1 | 82 | 27 | | 55 | 118 | | 5,70 |
| | | | 91381605 | 5 | P/1 | 101 | 27 | | 74 | 118 | | 7,00 |
| | | | 91381606 | 6 | P/1 | 120 | 27 | | 93 | 118 | | 8,30 |
| 170 | | | 91381702 | 2 | D | 44 | 27 | | 8,5 | 128 | 27 | 3,40 |
| | | 91361703 | 91381703 | 3 | D | 63 | 27 | | 18 | 128 | 27 | 5,10 |
| | | | 91381704 | 4 | D | 82 | 27 | | 27,5 | 128 | 27 | 5,90 |
| | | | 91381705 | 5 | D | 101 | 27 | | 37 | 128 | 27 | 7,40 |
| | | | | | | | | | | | | |
| 180 | | | | 1 | P | 25 | | | | | | 3,10 |
| | | 91361802 | 91381802 | 2 | D | 44 | 27 | | 8,5 | 138 | 27 | 3,90 |
| | | 91361803 | 91381803 | 3 | D | 63 | 27 | | 18 | 138 | 27 | 5,20 |
| | | 91361804 | 91381804 | 4 | D | 82 | 27 | | 27,5 | 138 | 27 | 6,20 |
| | | | 91381805 | 5 | D | 101 | 27 | | 37 | 138 | 27 | 7,50 |
| | | | 91381806 | 6 | D | 120 | 27 | | 46,5 | 138 | 27 | 8,90 |

MATERIAL **CAST-IRON**

CAD drawings available on our site
www.chiaravalli.com

Quantity, availability and prices
 on B2B Chiaravalli

www.bibiscom.ro

V-BELT PULLEYS for LOCKING DEVICES SPB

V-BELT PULLEYS for LOCKING DEVICES



V-BELT PULLEYS for LOCKING DEVICES SPB

for LOCKING DEVICES

SPB TYPE

DISC

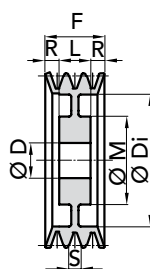

D

SPOKES

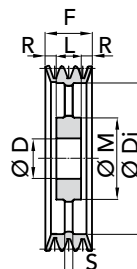

R

SOLID

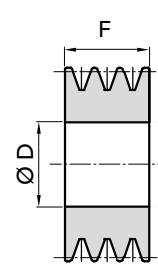

P

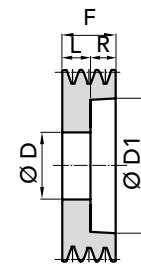

P/1

| Dp | P. NUMBER Ø 55 H8 | P. NUMBER Ø 65 H8 | P. NUMBER Ø 80 H8 | N° GROOVES | EXEC. | F | L | Ø M | R | Ø Di | S | WEIGHT Kg. |
|-----|----------------------|--|----------------------|---------------|-------|-----|----|-----|------|------|----|---------------|
| 190 | | 91361901 | 91381902 | 1 | P | 25 | | | | | | 3,50 |
| | | | 91381903 | 2 | D | 44 | 27 | | 8,5 | 148 | 27 | 6,50 |
| | | | 91381904 | 3 | D | 63 | 27 | | 18 | 148 | 27 | 7,00 |
| | | | 91381905 | 4 | D | 82 | 27 | | 27,5 | 148 | 27 | 8,00 |
| | | | | 5 | D | 101 | 27 | | 37 | 148 | 27 | 9,00 |
| 200 | | 91362001 91372002 91362003 91362004 | 91382001 | 1 | P | 25 | | | | | | 4,00 |
| | | | 91382002 | 2 | D | 44 | 27 | 120 | 8,5 | 158 | 15 | 7,00 |
| | | | 91382003 | 3 | D | 63 | 27 | 120 | 18 | 158 | 15 | 8,00 |
| | | | 91382004 | 4 | D | 82 | 27 | 120 | 27,5 | 158 | 15 | 9,00 |
| | | | 91382005 | 5 | D | 101 | 27 | 120 | 37 | 158 | 15 | 10,0 |
| | | | 91382006 | 6 | D | 120 | 27 | 120 | 46,5 | 158 | 18 | 11,0 |
| 212 | | 91362122 91362123 91362124 | 91382122 | 2 | D | 44 | 27 | 120 | 8,5 | 170 | 15 | 7,00 |
| | | | 91382123 | 3 | D | 63 | 27 | 120 | 18 | 170 | 15 | 8,50 |
| | | | 91382124 | 4 | D | 82 | 27 | 120 | 27,5 | 170 | 15 | 10,0 |
| | | | 91382125 | 5 | D | 101 | 27 | 120 | 37 | 170 | 15 | 11,0 |
| | | | | | | | | | | | | |
| 225 | 91352253 | 91372252 91362253 91362254 | 91382252 | 2 | D | 44 | 27 | 120 | 8,5 | 183 | 15 | 7,70 |
| | | | 91382253 | 3 | D | 63 | 27 | 120 | 18 | 183 | 15 | 9,00 |
| | | | 91382254 | 4 | D | 82 | 27 | 120 | 27,5 | 183 | 15 | 10,5 |
| | | | 91382255 | 5 | D | 101 | 27 | 120 | 37 | 183 | 15 | 11,5 |
| | | | 91382256 | 6 | D | 120 | 27 | 120 | 46,5 | 183 | 18 | 13,0 |
| | | | | | | | | | | | | |
| 240 | | | 91382403 | 3 | D | 63 | 27 | 120 | 18 | 198 | 16 | 11,0 |
| 250 | 91352501 91352502 | 91372502 91372503 91362504 | 91382502 | 1 | D | 25 | 25 | 130 | | 208 | 16 | 6,20 |
| | | | 91382503 | 2 | D | 44 | 27 | 130 | 8,5 | 208 | 16 | 8,50 |
| | | | 91382504 | 3 | D | 63 | 27 | 130 | 18 | 208 | 16 | 11,0 |
| | | | 91382505 | 4 | D | 82 | 27 | 130 | 27,5 | 208 | 16 | 12,0 |
| | | | 91382506 | 5 | D | 101 | 27 | 130 | 37 | 208 | 16 | 18,0 |
| | | | | 6 | D | 120 | 27 | 130 | 46,5 | 208 | 18 | 22,0 |
| 280 | | | 91382802 | 1 | D | 25 | 25 | 120 | | 238 | 16 | 6,50 |
| | | | 91382803 | 2 | D | 44 | 27 | 120 | 8,5 | 238 | 16 | 10,0 |
| | | | 91382804 | 3 | D | 63 | 27 | 120 | 18 | 238 | 16 | 12,5 |
| | | | 91382805 | 4 | D | 82 | 27 | 120 | 27,5 | 238 | 16 | 14,0 |
| | | | | 5 | D | 101 | 27 | 130 | 37 | 238 | 16 | 21,0 |
| 300 | 91353001 | | 91383004 | 1 | R | 25 | 25 | 130 | | 258 | 15 | 7,00 |
| | | | 91383005 | 4 | R | 82 | 27 | 130 | 27,5 | 258 | 20 | 16,0 |
| | | | | 5 | R | 101 | 27 | 130 | 37 | 258 | 22 | 19,0 |
| 315 | | 91363153 | 91383154 | 3 | R | 63 | 27 | 130 | 18 | 273 | 18 | 14,0 |
| | | | 91383155 | 4 | R | 82 | 27 | 130 | 27,5 | 273 | 20 | 20,0 |
| | | | | 5 | R | 101 | 27 | 130 | 37 | 273 | 22 | 22,0 |
| 355 | 91353551 | | | 1 | R | 25 | 25 | 130 | | 308 | 16 | 16,0 |

MATERIAL **CAST-IRON**CAD drawings available on our site
www.chiaravalli.comQuantity, availability and prices
on B2B Chiaravalliwww.bibiscom.ro



V-BELT PULLEYS for LOCKING DEVICES

33

for LOCKING DEVICES

SPC TYPE

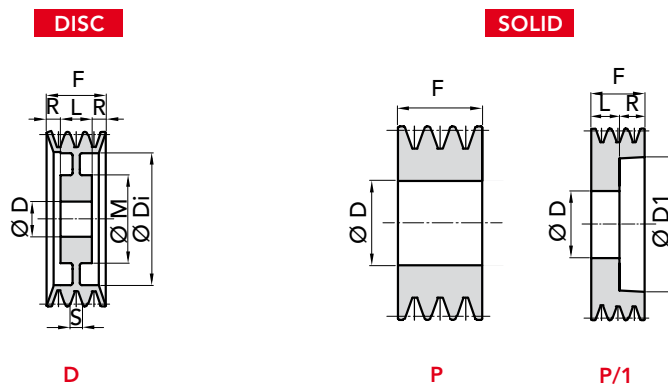

| Dp | P. NUMBER Ø 55 H8 | P. NUMBER Ø 65 H8 | P. NUMBER Ø 80 H8 | N° GROOVES | EXEC. | F | L | Ø M | R | Ø Di | S | WEIGHT Kg. |
|-----|----------------------|----------------------|----------------------|---------------|-------|----|----|-----|----|------|----|---------------|
| 160 | | | 91481603 | 3 | P/1 | 85 | 27 | | 58 | 103 | | 2,60 |
| 190 | | | 91481903 | 3 | P/1 | 85 | 27 | | 58 | 133 | | 2,90 |
| 225 | | | 91482253 | 3 | D | 85 | 27 | 120 | 29 | 168 | 25 | 3,40 |

MATERIAL **CAST-IRON**

CAD drawings available on our site
www.chiaravalli.com

Quantity, availability and prices
 on B2B Chiaravalli

www.bibiscom.ro

V-BELT PULLEYS for LOCKING DEVICES SPC

ADJUSTABLE V-BELTS PULLEY PRB TYPE



ADJUSTABLE V-BELTS PULLEY PRB TYPE

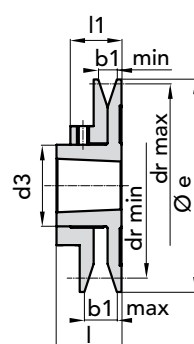
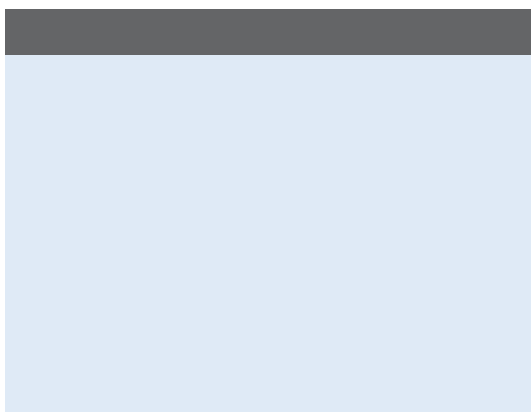

EXECUTION 1

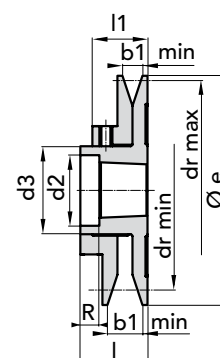

EXECUTION 2

| PULLEY TYPE | P. NUMBER | EXEC. | N° GROOVES | BUSHE | Ø e | l | l1 | b1 | | dr | | d2 | d3 | R | GRUB DIN 916 UNI 5929 | SECTION BELT | WEIGHT Kg. |
|-------------|-----------|-------|------------|-------|-----|------|------|-----|------|-----|-----|----|----|------|-----------------------|---------------------------------|------------|
| | | | | | | | | min | max | min | max | | | | | | |
| PRB - 93 | 90000931 | 2 | 1 | 1108 | 93 | 36,5 | 29 | 13 | 20,5 | 57 | 78 | 39 | 50 | 13,5 | No.4 M6x6 | Z 10x6 A 13x8 | 0,86 |
| PRB - 108 | 90001081 | 1 | 1 | 1215 | 108 | 38 | 30,5 | 13 | 20,5 | 68 | 92 | - | 60 | - | No.4 M6x6 | Z 10x6 A 13x8 SPZ SPA | 1,18 |
| PRB - 120 | 90001201 | 1 | 1 | 1215 | 120 | 38 | 30,5 | 13 | 20,5 | 80 | 104 | - | 60 | - | No.4 M6x6 | Z 10x6 A 13x8 SPZ SPA | 1,46 |
| PRB - 138 | 90001381 | 1 | 1 | 1615 | 138 | 38 | 30,5 | 13 | 20,5 | 98 | 122 | - | 74 | - | No.4 M6x6 | Z 10x6 A 13x8 SPZ SPA | 2,00 |
| PRB - 160 | 90001601 | 2 | 1 | 1615 | 160 | 45 | 35,5 | 17 | 26,5 | 108 | 138 | 58 | 74 | 6,5 | No.4 M8x8 | A 13x8 B 17x11 SPA SPB | 3,04 |
| PRB - 180 | 90001801 | 2 | 1 | 2012 | 180 | 45 | 35,5 | 17 | 26,5 | 128 | 158 | 71 | 90 | 12,5 | No.4 M8x8 | A 13x8 B 17x11 SPA SPB | 3,80 |
| PRB - 200 | 90002001 | 2 | 1 | 2012 | 200 | 45 | 35,5 | 17 | 26,5 | 149 | 177 | 71 | 90 | 12,5 | No.4 M8x8 | A 13x8 B 17x11 SPA SPB | 4,75 |

MATERIAL **CAST-IRON G20**
UNI 5007

CAD drawings available on our site
www.chiaravalli.com

Quantity, availability and prices
on B2B Chiaravalli

www.bibiscom.ro



ADJUSTABLE V-BELTS PULLEY PRB TYPE

35

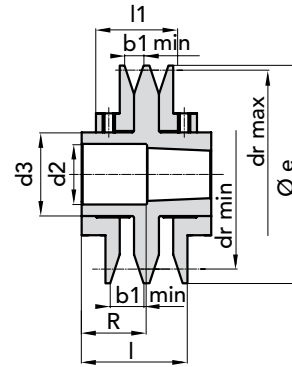

EXECUTION 3

| PULLEY TYPE | P. NUMBER | EXEC. N° | BUSHE GROOVES | Ø e | l | l1 | b1 | | dr | | d2 | d3 | R | GRUB DIN 916 UNI 5929 | SECTION BELT | WEIGHT Kg. | |
|-------------|-----------|----------|---------------|------|-----|----|-----|-----|------|-----|-----|------|----|-----------------------|---------------|---------------------------------|------|
| | | | | | | | min | max | min | max | | | | | | | |
| PRB2 - 108 | 90001082 | 3 | 2 | 1215 | 108 | 73 | 58 | 13 | 20,5 | 68 | 92 | 48,5 | 60 | 34,5 | No. 8 M6x6 | Z 10x6 A 13x8 SPZ SPA | 2,40 |
| | | | | | | | | | | 70 | 100 | | | | | | |
| | | | | | | | | | | 75 | 93 | | | | | | |
| | | | | | | | | | | 76 | 102 | | | | | | |
| PRB2 - 120 | 90001202 | 3 | 2 | 1215 | 120 | 73 | 58 | 13 | 20,5 | 80 | 104 | 48,5 | 60 | 34,5 | No. 8 M6x6 | Z 10x6 A 13x8 SPZ SPA | 2,65 |
| | | | | | | | | | | 82 | 112 | | | | | | |
| | | | | | | | | | | 87 | 105 | | | | | | |
| | | | | | | | | | | 88 | 114 | | | | | | |
| PRB2 - 138 | 90001382 | 3 | 2 | 1615 | 138 | 73 | 58 | 13 | 20,5 | 98 | 122 | 58,5 | 74 | 34,5 | No. 8 M6x6 | Z 10x6 A 13x8 SPZ SPA | 3,60 |
| | | | | | | | | | | 100 | 130 | | | | | | |
| | | | | | | | | | | 105 | 123 | | | | | | |
| | | | | | | | | | | 106 | 132 | | | | | | |
| PRB2 - 160 | 90001602 | 3 | 2 | 1615 | 160 | 87 | 68 | 17 | 26,5 | 108 | 138 | 58,5 | 74 | 48,5 | No. 8 M8x8 | A 13x8 B 17x11 SPA SPB | 5,60 |
| | | | | | | | | | | 112 | 150 | | | | | | |
| | | | | | | | | | | 114 | 140 | | | | | | |
| | | | | | | | | | | 117 | 153 | | | | | | |
| PRB2 - 180 | 90001802 | 3 | 2 | 2012 | 180 | 87 | 68 | 17 | 26,5 | 128 | 158 | 71 | 90 | 54 | No. 8 M8x8 | A 13x8 B 17x11 SPA SPB | 7,15 |
| | | | | | | | | | | 132 | 170 | | | | | | |
| | | | | | | | | | | 134 | 160 | | | | | | |
| | | | | | | | | | | 137 | 173 | | | | | | |
| PRB2 - 200 | 90002002 | 3 | 2 | 2012 | 200 | 87 | 68 | 17 | 26,5 | 149 | 177 | 71 | 90 | 54 | No. 8 M8x8 | A 13x8 B 17x11 SPA SPB | 8,92 |
| | | | | | | | | | | 152 | 190 | | | | | | |
| | | | | | | | | | | 155 | 179 | | | | | | |
| | | | | | | | | | | 159 | 193 | | | | | | |

MATERIAL **CAST-IRON G20**
UNI 5007

CAD drawings available on our site
www.chiaravalli.com

Quantity, availability and prices
on B2B Chiaravalli

www.bibiscom.ro

ADJUSTABLE V-BELTS PULLEY PRB TYPE

V-BELT PULLEYS MICRO-V TAPER LOCK®



TYPES

Grooved pulleys designed for industrial transmissions are identified by reference to the dimensions and the groove pitch in the following types: **PPV-J – PPV-L**

PROFILE DIMENSIONS

The transverse profile dimensions of a grooved pulley are shown in the figure and in the table.

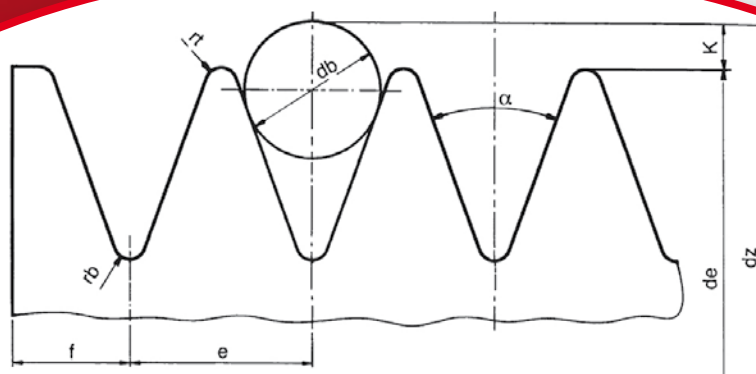

TABLE

| TYPE | PPV-J | PPV-L |
|--|--------|--------|
| Grooves pitch e | 2.34 | 4.70 |
| Tolerance for e* | ± 0.03 | ± 0.05 |
| Sum of tolerances e** | ± 0.30 | ± 0.30 |
| Race angle a** ±0,5 | 40° | 40° |
| rt min. | 0.20 | 0.40 |
| rb max | 0.40 | 0.40 |
| Diameter of the control sphere or roller db ± 0.01 | 1.50 | 3.50 |
| 2K** nominal | 0.23 | 2.36 |
| f min. | 1.8 | 3.3 |

* = this tolerance applies to the distance between the axes of two consecutive grooves

** = the sum of all the tolerances "e" for all the races of each pulley must not exceed the value foreseen in the table

* = the axis of each groove must form a $90^\circ \pm 0.5^\circ$ angle with the pulley axis

** = K is not in relation to the pulley's nominal diameter but is measured from the position of the measurement sphere or roller.



PITCH LINE DIAMETER

The position of a grooved belt in contact with the corresponding pulley is shown in cross-section in the figure.

The real pitch line diameter **dp** of a grooved pulley measured along the belt is slightly greater than the actual diameter **de** and the exact value depends on the type of belt used.

For the purposes of illustration, the table shows the value **be** normally adopted to calculate the transmission ratio.

In practice it is sufficient to use the actual diameter **de** to calculate the transmission ratio.

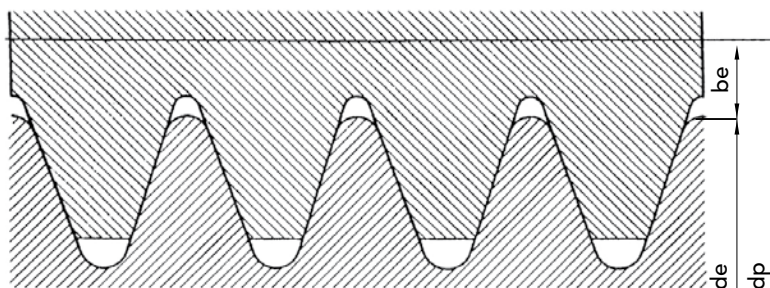

$$dp \cong de + 2be$$

| TYPE | PPV-J | PPV-L |
|------|-------|-------|
| 2 be | 2 | 5 |

DESIGNATION

The designation includes the following details, in the order given: the "pulley" domination, the reference of the current standard, the number of grooves, the type and the actual diameter expressed in millimetres.

An example of the designation for a PPV-J type grooved pulley designed for industrial transmissions with 8 grooves and an actual diameter of 200mm

8 PPV-J 200

DEGREE OF FINISH OF THE GROOVES

The surface roughness of the grooves shall be Ra 3.2 in compliance with ISO 254.

MATERIALS

C45 UNI 7845

Pulleys are manufactured in steel.

BALANCING

UNI 4218 – ISO 1940

Pulleys prepared for a tapered bush are statically balanced within grade G.6.3.

It is possible to perform dynamic balancing, on request.

Dynamic balancing is essential for speeds exceeding 30 m/s.

V-BELT PULLEYS MICRO-V TAPER LOCK®



DESIGN POWER CALCULATION

Make a note of the nominal power to be transmitted **P** (kw) (normally the nominal power of the electric motor), select the service factor **Co** based on the table and calculate the design power output **Pc** (kw) as follows: **Pc = Co x P**

Service factor (Co)

MOTOR TYPE

CLASS A

- Synchronous and asynchronous, squirrel cage, normal torque, alternating current motor.
- Shunt winding direct current motor
- Internal combustion engine (steady-state condition ³ 700 r.p.m.)
- Turbines

CLASS B

- Asynchronous, squirrel cage, high torque alternating current motor
- Compound winding direct current motor
- Internal combustion engine (steady-state condition ³ 700 r.p.m.)
- Clutches

| TYPE OF MACHINE DRIVEN | Class A Motor | | | Class B Motor | | |
|---|---------------------------------|-------|-----|---------------|--------|-----|
| | Number of daily operating hours | | | | | |
| | <10 | 10÷16 | >16 | <10 | <10÷16 | >16 |
| • Liquid mixers • Blowers • Extractors • Centrifuge fans • Lightweight conveyors | 1 | 1.1 | 1.2 | 1.1 | 1.2 | 1.3 |
| • Mixers designed for pasty products • Blenders • Generators • Laundry machines • Machine tools | 1.1 | 1.2 | 1.3 | 1.2 | 1.3 | 1.4 |
| • Rotary compressors • Rotary pumps • Sieves • Heavyweight conveyors • Spraying systems • Dynamo • Bakery machines • Printing machines • Wood working machines • Axial fans • Brick making machines | 1.2 | 1.3 | 1.4 | 1.3 | 1.4 | 1.5 |
| • Piston compressors • Piston pumps • Crushers • Bucket elevators • Elevators • Paper making machines • Mills • Hoists | 1.4 | 1.5 | 1.6 | 1.5 | 1.6 | 1.8 |
| • Grinding machines • Crushing machines • Drainage systems • Calenders and extruders for rubber and plastics | 1.6 | 1.7 | 1.8 | 1.7 | 1.8 | 2 |

CROSS-SECTION SELECTION

R.p.m. of smallest pulley The type of cross-section is selected by using the diagram shown below.

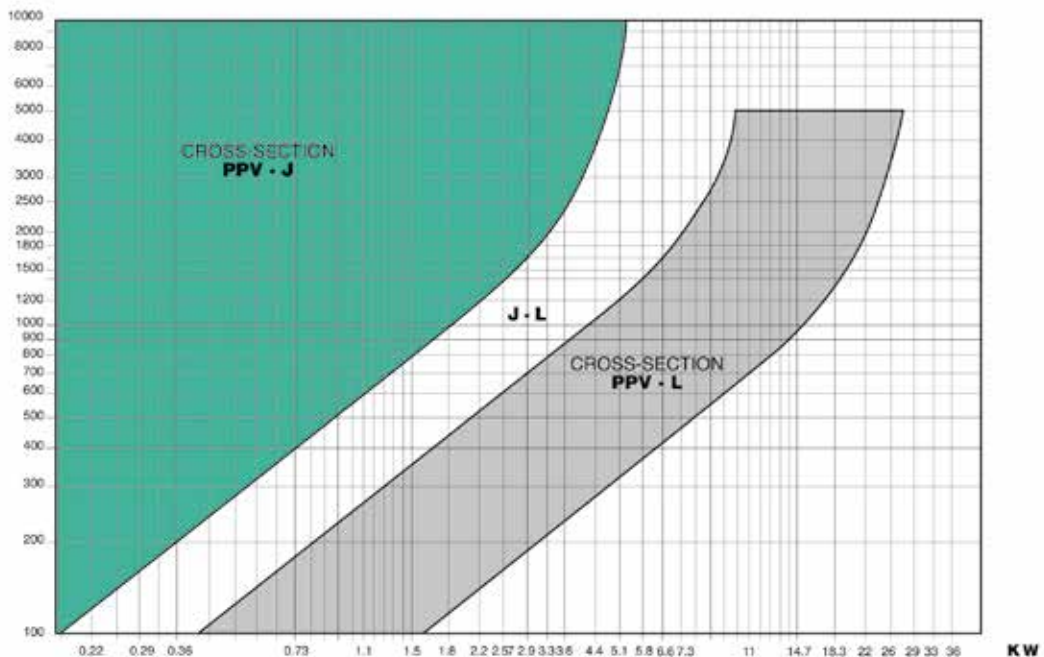



V-BELT PULLEYS PPV-J MICRO V DIMENSIONS

39

PPV-J TYPE

N° GROOVES $F \pm 0.1$

| | | |
|----|------|------|
| 8 | 23 | 3.31 |
| 12 | 32.5 | 3.38 |
| 16 | 42 | 3.45 |

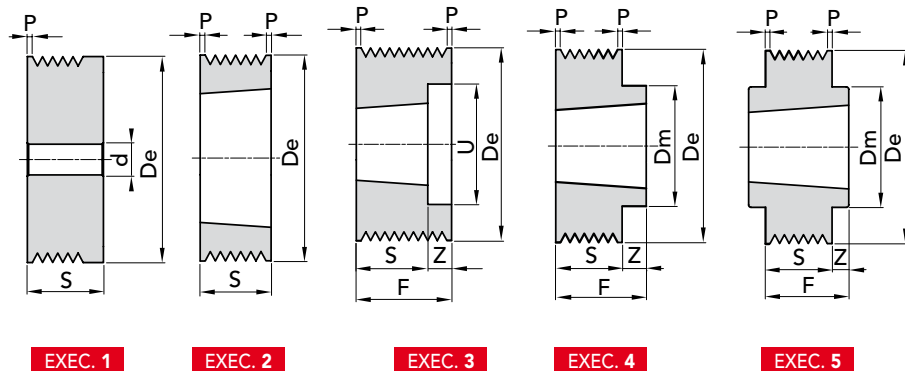

| De | P. NUMBER | EXEC. | N° GROOVES | BUSHE | S | Z | Dm | U | d | WEIGHT Kg. |
|-----|-----------|-------|------------|-------|------|-----|----|----|----|------------|
| 40 | 48108040 | 1 | 8 | - | 32 | - | - | - | 12 | 0,24 |
| | 48112040 | 1 | 12 | - | 41,5 | - | - | - | 12 | 0,31 |
| | 48116040 | 1 | 16 | - | 51 | - | - | - | 12 | 0,38 |
| 45 | 48108045 | 1 | 8 | - | 32 | - | - | - | 12 | 0,32 |
| | 48112045 | 1 | 12 | - | 41,5 | - | - | - | 12 | 0,41 |
| | 48116045 | 1 | 16 | - | 51 | - | - | - | 12 | 0,50 |
| 50 | 48108050 | 1 | 8 | - | 32 | - | - | - | 12 | 0,40 |
| | 48112050 | 1 | 12 | - | 41,5 | - | - | - | 12 | 0,52 |
| | 48116050 | 1 | 16 | - | 51 | - | - | - | 12 | 0,63 |
| 56 | 48108056 | 2 | 8 | 1108 | 23 | - | - | - | - | 0,39 |
| | 48112056 | 3 | 12 | 1108 | 32,5 | 9,5 | - | 40 | - | 0,65 |
| | 48116056 | 1 | 16 | - | 51 | - | - | - | 12 | 0,81 |
| 63 | 48108063 | 2 | 8 | 1108 | 23 | - | - | - | - | 0,50 |
| | 48112063 | 3 | 12 | 1108 | 23 | 9,5 | - | 46 | - | 0,39 |
| | 48116063 | 1 | 16 | - | 51 | - | - | - | 12 | 1,05 |
| 71 | 48108071 | 2 | 8 | 1108 | 23 | - | - | - | - | 0,64 |
| | 48112071 | 3 | 12 | 1108 | 23 | 9,5 | - | 46 | - | 0,57 |
| | 48116071 | 2 | 16 | 1215 | 42 | - | - | 55 | - | 0,63 |
| 75 | 48108075 | 2 | 8 | 1108 | 23 | - | - | - | - | 0,72 |
| | 48112075 | 3 | 12 | 1610 | 26 | 6,5 | - | 60 | - | 0,38 |
| | 48116075 | 3 | 16 | 1610 | 26 | 16 | - | 60 | - | 0,46 |
| 80 | 48108080 | 4 | 8 | 1610 | 26 | 3 | 70 | - | - | 0,41 |
| | 48112080 | 3 | 12 | 1610 | 26 | 6,5 | - | 60 | - | 0,52 |
| | 48116080 | 3 | 16 | 1610 | 26 | 16 | - | 60 | - | 0,64 |
| 85 | 48108085 | 4 | 8 | 1610 | 26 | 3 | 70 | - | - | 0,51 |
| | 48112085 | 3 | 12 | 1610 | 26 | 6,5 | - | 60 | - | 0,66 |
| | 48116085 | 3 | 16 | 1610 | 26 | 16 | - | 60 | - | 0,84 |
| 90 | 48108090 | 4 | 8 | 1610 | 26 | 3 | 70 | - | - | 0,62 |
| | 48112090 | 3 | 12 | 1610 | 26 | 6,5 | - | 74 | - | 0,76 |
| | 48116090 | 3 | 16 | 1610 | 26 | 16 | - | 74 | - | 0,87 |
| 95 | 48108095 | 4 | 8 | 1610 | 26 | 3 | 82 | - | - | 0,78 |
| | 48112095 | 3 | 12 | 1610 | 26 | 6,5 | - | 74 | - | 0,93 |
| | 48116095 | 3 | 16 | 1610 | 26 | 16 | - | 74 | - | 1,08 |
| 100 | 48108100 | 4 | 8 | 1610 | 26 | 3 | 82 | - | - | 0,90 |
| | 48112100 | 3 | 12 | 1610 | 26 | 6,5 | - | 74 | - | 1,10 |
| | 48116100 | 3 | 16 | 1610 | 26 | 16 | - | 74 | - | 1,32 |

| De | P. NUMBER | EXEC. | N° GROOVES | BUSHE | S | Z | Dm | U | d | WEIGHT Kg. |
|-----|-----------|-------|------------|-------|----|------|-----|----|---|------------|
| 106 | 48108106 | 4 | 8 | 1610 | 26 | 3 | 82 | - | - | 1,05 |
| | 48112106 | 3 | 12 | 1610 | 26 | 6,5 | - | 88 | - | 1,24 |
| | 48116106 | 3 | 16 | 1610 | 26 | 16 | - | 88 | - | 1,40 |
| 112 | 48108112 | 4 | 8 | 1610 | 26 | 3 | 90 | - | - | 1,25 |
| | 48112112 | 3 | 12 | 1610 | 26 | 6,5 | - | 88 | - | 1,47 |
| | 48116112 | 3 | 16 | 1610 | 26 | 16 | - | 88 | - | 1,70 |
| 118 | 48108118 | 4 | 8 | 1610 | 26 | 3 | 90 | - | - | 1,43 |
| | 48112118 | 3 | 12 | 2012 | 32 | 0,5 | - | 98 | - | 1,55 |
| | 48116118 | 3 | 16 | 2012 | 32 | 10 | - | 98 | - | 1,79 |
| 125 | 48108125 | 4 | 8 | 1610 | 26 | 3 | 90 | - | - | 1,64 |
| | 48112125 | 3 | 12 | 2012 | 32 | 0,5 | - | 98 | - | 1,90 |
| | 48116125 | 3 | 16 | 2012 | 32 | 10 | - | 98 | - | 2,18 |
| 132 | 48108132 | 4 | 8 | 1610 | 26 | 3 | 90 | - | - | 1,88 |
| | 48112132 | 3 | 12 | 2012 | 32 | 0,5 | - | 98 | - | 2,21 |
| | 48116132 | 3 | 16 | 2012 | 32 | 10 | - | 98 | - | 2,60 |
| 140 | 48108140 | 4 | 8 | 1610 | 26 | 3 | 90 | - | - | 1,60 |
| | 48112140 | 4 | 12 | 2517 | 45 | 12,5 | 120 | - | - | 7,10 |
| | 48116140 | 4 | 16 | 2517 | 45 | 3 | 120 | - | - | 9,60 |
| 160 | 48108160 | 5 | 8 | 2012 | 32 | 4,5 | 110 | - | - | 3,01 |
| | 48112160 | 4 | 12 | 2517 | 45 | 12,5 | 120 | - | - | 3,80 |
| | 48116160 | 4 | 16 | 2517 | 45 | 3 | 120 | - | - | 4,37 |
| 180 | 48108180 | 5 | 8 | 2012 | 32 | 4,5 | 110 | - | - | 3,92 |
| | 48112180 | 5 | 12 | 2517 | 45 | 6,25 | 120 | - | - | 5,03 |
| | 48116180 | 5 | 16 | 2517 | 45 | 1,5 | 120 | - | - | 5,97 |
| 200 | 48108200 | 5 | 8 | 2012 | 32 | 4,5 | 110 | - | - | 4,88 |
| | 48112200 | 5 | 12 | 2517 | 45 | 6,25 | 120 | - | - | 6,40 |
| | 48116200 | 5 | 16 | 2517 | 45 | 1,5 | 120 | - | - | 7,75 |
| 224 | 48108224 | 5 | 8 | 2012 | 32 | 4,5 | 110 | - | - | 6,17 |
| | 48112224 | 5 | 12 | 2517 | 45 | 6,25 | 120 | - | - | 8,29 |
| | 48116224 | 5 | 16 | 2517 | 45 | 1,5 | 120 | - | - | 10,10 |
| 250 | 48108250 | 5 | 8 | 2012 | 32 | 4,5 | 110 | - | - | 7,73 |
| | 48112250 | 5 | 12 | 2517 | 45 | 6,25 | 120 | - | - | 1,05 |
| | 48116250 | 5 | 16 | 2517 | 45 | 1,5 | 120 | - | - | 1,30 |

V-BELT PULLEYS PPV-J MICRO V DIMENSIONS

V-BELT PULLEYS PPV-L MICRO V DIMENSIONS



PPV-L TYPE

| N° GROOVES | | F±0.1 |
|------------|----|-------|
| 8 | 48 | 7.55 |
| 12 | 67 | 7.65 |
| 16 | 86 | 7.75 |

| | | |
|----|----|------|
| 8 | 48 | 7.55 |
| 12 | 67 | 7.65 |
| 16 | 86 | 7.75 |

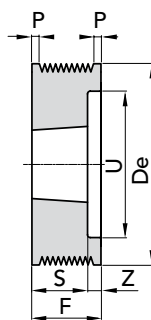

EXEC. 3

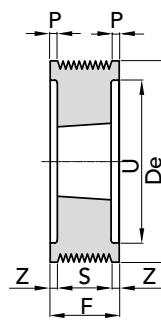

EXEC. 6

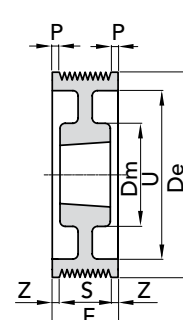

EXEC. 7

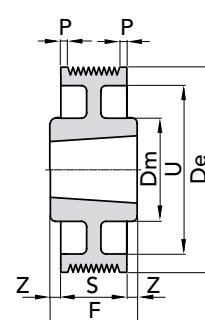

EXEC. 8

| De | P. NUMBER | EXEC. | N° GROOVES | BUSHE | S | Z | Dm | U | WEIGHT Kg. |
|-----|-----------|-------|------------|-------|----|------|----|-----|------------|
| 75 | 48208075 | 3 | 8 | 1210 | 26 | 22 | - | 56 | 0,66 |
| | 48212075 | 3 | 12 | 1215 | 42 | 25 | - | 56 | 0,97 |
| 80 | 48208080 | 3 | 8 | 1210 | 26 | 22 | - | 56 | 0,86 |
| | 48212080 | 3 | 12 | 1215 | 42 | 25 | - | 56 | 1,25 |
| 85 | 48208085 | 3 | 8 | 1210 | 26 | 22 | - | 61 | 1,00 |
| | 48212085 | 3 | 12 | 1215 | 42 | 25 | - | 61 | 1,47 |
| | 48216085 | 6 | 16 | 1215 | 42 | 22 | - | 61 | 1,76 |
| 90 | 48208090 | 3 | 8 | 1610 | 26 | 22 | - | 66 | 1,01 |
| | 48212090 | 3 | 12 | 1615 | 42 | 25 | - | 66 | 1,45 |
| | 48216090 | 6 | 16 | 1615 | 42 | 22 | - | 66 | 1,78 |
| 95 | 48208095 | 3 | 8 | 1610 | 26 | 22 | - | 71 | 1,16 |
| | 48212095 | 3 | 12 | 1615 | 42 | 25 | - | 71 | 1,71 |
| | 48216095 | 6 | 16 | 1615 | 42 | 22 | - | 71 | 2,02 |
| 100 | 48208100 | 3 | 8 | 1610 | 26 | 22 | - | 76 | 1,31 |
| | 48212100 | 3 | 12 | 2012 | 32 | 35 | - | 79 | 1,39 |
| | 48216100 | 6 | 16 | 2012 | 32 | 27 | - | 79 | 1,69 |
| 106 | 48208106 | 3 | 8 | 1610 | 26 | 22 | - | 82 | 1,53 |
| | 48212106 | 3 | 12 | 2012 | 32 | 35 | - | 82 | 1,76 |
| | 48216106 | 6 | 16 | 2012 | 32 | 27 | - | 82 | 2,12 |
| 112 | 48208112 | 3 | 8 | 1610 | 26 | 22 | - | 88 | 1,75 |
| | 48212112 | 3 | 12 | 2012 | 32 | 35 | - | 88 | 2,02 |
| | 48216112 | 6 | 16 | 2012 | 32 | 27 | - | 88 | 2,42 |
| 118 | 48208118 | 3 | 8 | 2012 | 32 | 16 | - | 94 | 1,88 |
| | 48212118 | 6 | 12 | 2517 | 45 | 11 | - | 97 | 1,96 |
| | 48216118 | 6 | 16 | 2517 | 45 | 20,5 | - | 97 | 2,31 |
| 125 | 48208125 | 3 | 8 | 2012 | 32 | 16 | - | 101 | 2,22 |
| | 48212125 | 6 | 12 | 2517 | 45 | 11 | - | 101 | 2,46 |
| | 48216125 | 6 | 16 | 2517 | 45 | 20,5 | - | 101 | 2,92 |
| 132 | 48208132 | 3 | 8 | 2012 | 32 | 16 | - | 108 | 2,54 |
| | 48212132 | 6 | 12 | 2517 | 45 | 11 | - | 108 | 2,97 |
| | 48216132 | 6 | 16 | 2517 | 45 | 20,5 | - | 108 | 3,44 |

| De | P. NUMBER | EXEC. | N° GROOVES | BUSHE | S | Z | Dm | U | WEIGHT Kg. |
|-----|-----------|-------|------------|-------|----|------|-----|-----|------------|
| 140 | 48208140 | 3 | 8 | 2517 | 45 | 3 | 82 | 116 | 3,02 |
| | 48212140 | 6 | 12 | 2517 | 45 | 11 | - | 116 | 3,55 |
| | 48216140 | 6 | 16 | 2517 | 45 | 20,5 | - | 116 | 4,05 |
| 150 | 48208150 | 3 | 8 | 2517 | 45 | 3 | - | 126 | 3,75 |
| | 48212150 | 6 | 12 | 2517 | 45 | 11 | - | 126 | 4,30 |
| | 48216150 | 6 | 16 | 2517 | 45 | 20,5 | - | 126 | 4,85 |
| 160 | 48208160 | 3 | 8 | 2517 | 45 | 3 | - | 136 | 4,54 |
| | 48212160 | 6 | 12 | 2517 | 45 | 11 | - | 136 | 5,12 |
| | 48216160 | 6 | 16 | 3020 | 52 | 17 | - | 136 | 4,88 |
| 170 | 48208170 | 3 | 8 | 2517 | 45 | 3 | - | 146 | 5,35 |
| | 48212170 | 6 | 12 | 2517 | 45 | 11 | - | 146 | 6,03 |
| | 48216170 | 6 | 16 | 3020 | 52 | 17 | - | 146 | 5,96 |
| 180 | 48208180 | 7 | 8 | 2517 | 45 | 1,5 | 120 | 156 | 4,52 |
| | 48212180 | 7 | 12 | 2517 | 45 | 11 | 120 | 156 | 5,34 |
| | 48216180 | 6 | 16 | 3020 | 52 | 17 | - | 156 | 7,09 |
| 200 | 48208200 | 7 | 8 | 2517 | 45 | 1,5 | 120 | 176 | 5,07 |
| | 48212200 | 7 | 12 | 3020 | 52 | 7,5 | 146 | 176 | 6,99 |
| | 48216200 | 7 | 16 | 3020 | 52 | 17 | 146 | 176 | 7,92 |
| 224 | 48208224 | 7 | 8 | 2517 | 45 | 1,5 | 120 | 202 | 9,77 |
| | 48212224 | 7 | 12 | 3020 | 52 | 7,5 | 146 | 202 | 11,0 |
| | 48216224 | 7 | 16 | 3020 | 52 | 17 | 146 | 202 | 14,12 |
| 250 | 48208250 | 8 | 8 | 3020 | 52 | 2 | 146 | 228 | 13,12 |
| | 48212250 | 7 | 12 | 3020 | 52 | 7,5 | 146 | 228 | 15,60 |
| | 48216250 | 8 | 16 | 3535 | 89 | 1,5 | 178 | 228 | 16,13 |
| 280 | 48208280 | 8 | 8 | 3020 | 52 | 2 | 146 | 256 | 18,18 |
| | 48212280 | 7 | 12 | 3020 | 52 | 7,5 | 146 | 256 | 21,75 |
| | 48216280 | 8 | 16 | 3535 | 89 | 1,5 | 178 | 256 | 24,45 |
| 315 | 48208315 | 8 | 8 | 3020 | 52 | 2 | 146 | 285 | 24,82 |
| | 48212315 | 8 | 12 | 3535 | 89 | 11 | 178 | 285 | 42,64 |
| | 48216315 | 8 | 16 | 3535 | 89 | 1,5 | 178 | 285 | 35,34 |



SPECIAL

COMPONENTS MANUFACTURING

We produce high precision Gears and Special Mechanical Components.

A large and varied range of modern CNC machine tools assures large capacity production at high quality level.

Chiaravalli Group SpA co-workers, highly skilful and motivated by a great spirit of belonging to the company,

operate using the most modern CAE and CAD-CAM technologies. The production is certified and assured using three-dimensional high precision measuring machines.

Chiaravalli Group SpA your technological partner for high quality production.





WORM SCREW

JACKS

The new line of Worm Screw Jacks named CHT (Chiaravalli High Tech) integrates and completes our range of Mechanical Transmission products.

This new line of products is manufactured using high quality materials, manufactured with absolute precision, making use of the modern machinery fleet of the companies belonging to Chiaravalli Group SpA.

The basic elements that make up the final product "Screw Jack" are made in large series, rigorously checked and put in stock.

Special virtual software developed by Chiaravalli Group SpA enables our customers to first view the various elements of the required screw jack and then, in the second phase, to order it with absolute precision and confidence.

Chiaravalli Group SpA is engaged to ensure the delivery of this product in very short time, with quality and precision.

