

Welcome/Table of Contents

Congratulations on the purchase of your new PetScribe™/N'Scriber™ engraving system. The following manual serves as a guide on proper unpacking, set up, installation and usage for this unit.

ITEMS INCLUDED ARE: PetScribe™/N'Scriber™ unit, keyboard, power cord, tag holder, assorted tags, split rings.

TABLE OF CONTENTS

Pg.Section
1Welcome to PetScribe™/N'Scriber™
2Setting Up Your PetScribe™/N'Scriber™
3Installing/Changing the Tag Holder
5Engraving a Tag
6Tag Counts / Software Update
7Change Lang. / Double Engraving / Change Font
8Registration
9PetScribe™/N'Scriber™ Templates

To report problems, call 1-888-600-8247



Unpacking your PetScribe™/N'Scriber™



Fig. 2-1



Fig. 2-2

Fig. 2-1 Place shipping carton on a flat surface with red arrows pointing up. Open carton and remove the top protective foam insert.

Fig. 2-2 Next remove the insert containing the keyboard and supply of tags.



Fig. 2-3



Fig. 2-4

Fig. 2-3 The power cord is located inside the box beside the unit.

Fig. 2-4 The PetScribe™/N'Scriber™ can now be removed from the carton. It's a tight fit so you may need help to hold the box. Grab the unit by the front and back, then pull straight up. After clearing the box place unit on a desk or counter where it will operate.



Fig. 2-5



Fig. 2-6



Fig. 2-7

Powering up your PetScribe™/N'Scriber™

Fig. 2-5 Insert power cord into the extension on the bottom of the unit. **DO NOT PLUG INTO THE WALL SOCKET AT THIS TIME.**

Fig. 2-6 Insert keyboard plug into the receptacle on the front of the unit. The plug is keyed so be sure not to force it.

Fig. 2-7 Plug the unit into the wall, then flip the power rocker switch located under the front right corner.

Installing/Changing the Tag Holder



In about 10 seconds your PetScribe™/N'Scriber™ will flash a Welcome Screen, then the following Main Menu screen will be displayed.



Current Tag Style: Small Circle
F1: Engrave Tag (1x)
F2: Change Tag Style
F3: Change Font - Standard

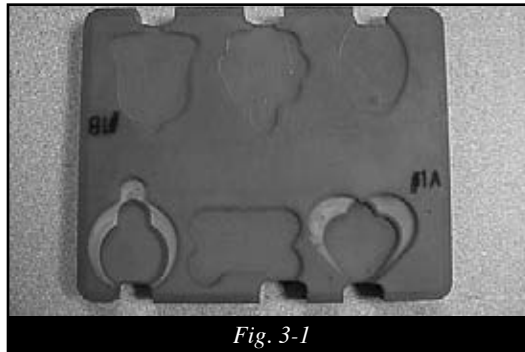

Fig. 3-1

Fig. 3-1 The tag holder was included with the unit. It's located in the foam insert with the keyboard and tags.



Fig. 3-2

Fig. 3-2 Press "F2" on the keyboard. When the following screen appears, use the "Up" and "Down" arrow keys to select the correct tag style, then press "F1".

<p>Select Tag (Use ↑/↓ Keys) F1: Select F10: Cancel</p>	<p>Large Heart Heart Small Circle Large => Circle Small</p>
---	---

Fig. 3-3 The door will open and the platform will move out to the install position.

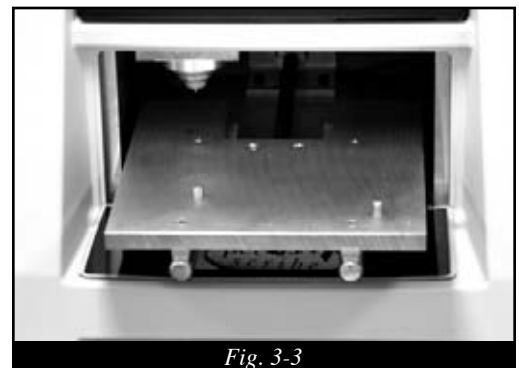

Fig. 3-3

Note:
 An [H] after a tag style means the tag engraves **Horizontally**, while a [V] means **Vertical**. See the template section of this manual for a graphic representation.

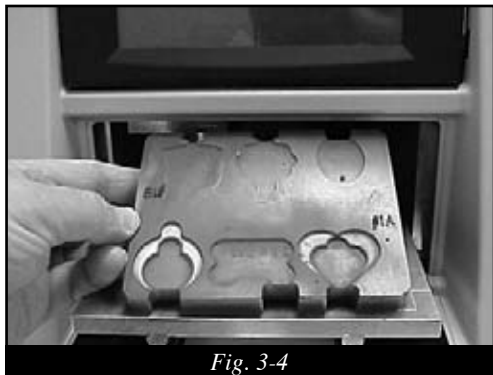

Fig. 3-4

Fig. 3-4 Install the tag holder onto the platform with the style to be engraved to the front.

Installing/Changing the Tag Holder

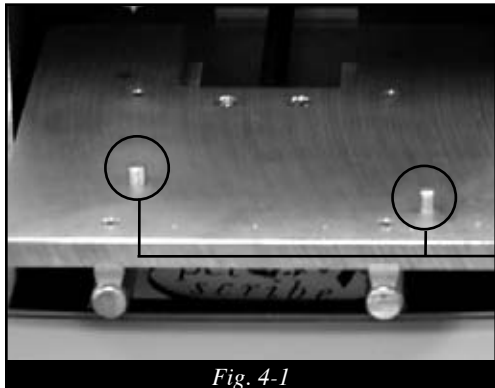

Fig. 4-1 The two guide pins will insure the holder is properly aligned.

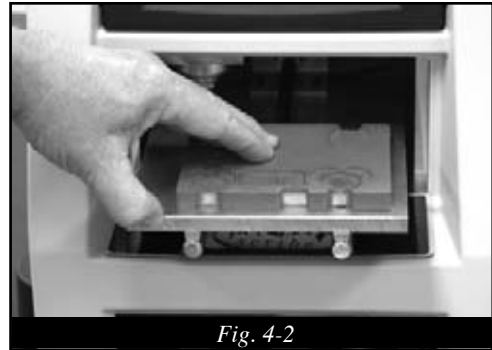

Fig. 4-2 Press firmly down to seat.

The following screen should be displayed, press “F1” after the correct tag holder is installed.

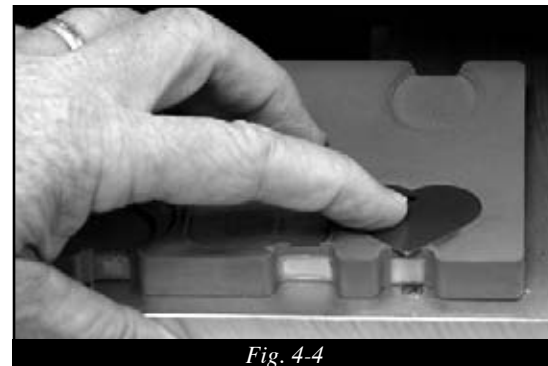
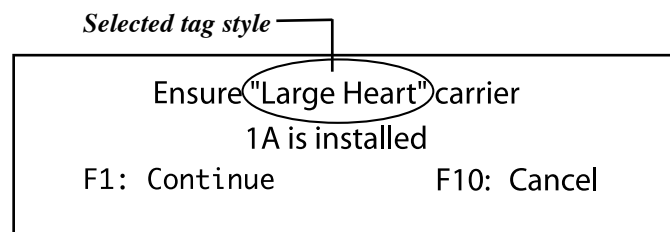

Fig.4-3 Insert the tag to be engraved.

Fig. 4-4 When the tag is properly seated and the following screen is displayed, press “F1” to engrave an ID tag.





Engraving a Tag

The unit will display the following input screen indicating the maximum number of lines the tag can hold. Use the keyboard to enter the tag information.

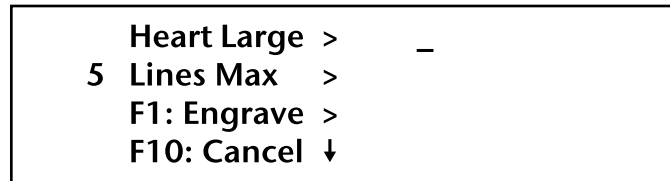

The text will be centered automatically on the tag.

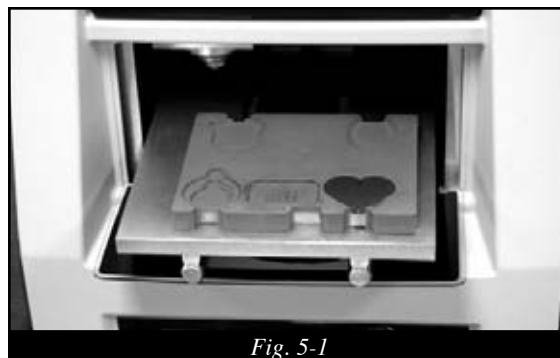

Fig. 5-1

Fig. 5-1 When finished entering the information, press “*FI*” and the platform will be pulled into the unit, the door will close, and the tag will be engraved. When the engraver is finished, the door will open and the platform will extend the finished tag.

Remove the engraved tag. If desired, additional tags of the same style may be engraved at this time. The information on the additional tags may be updated if required then press “*FI*” to begin the engraving process.

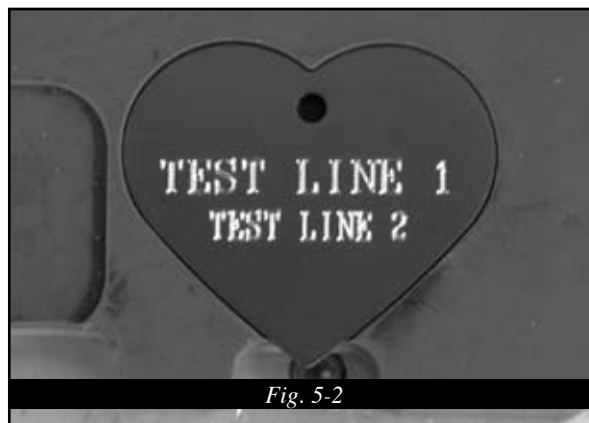

Fig. 5-2

Fig. 5-2 *The size of the characters changes with the number of lines and characters entered. Fewer lines and characters on a line result in larger letters.*

Approximately two minutes after the last tag is engraved the door will close and the main menu screen will be displayed. The unit is now ready for new commands.



Tag Counts

While the Main Menu is displayed press the “*Home*” key on the keyboard. The unit will display the following screen.

Total	: 12345
Bone:	123
Large Heart:	123
Bell:	123
Military:	123
Large Circle:	123
Luggage:	123
Oval:	123
Rosette:	123
Small Circle:	123
Small Heart:	123
Large Rivet:	123
Small Rivet:	123
Large Decor:	123
Small Decor:	123
Ornament:	123

Use the “Arrow” keys on the keyboard to scroll down and up to see additional tag styles.

When you’re finished checking tag counts press the “Esc” key to return to the Main Menu.

Software Update

- Turn off the power
- Insert the compact flash card into the “Update Port”
- Turn on the power and the following screen will appear

Press “D” To download Firmware
Press “Enter” to Not Download Firmware

- Press “D”
- When finished, power down the unit.
- Remove the compact flash card.

This function will be used to add new tag styles when they become available. Each software update will come with additional instructions to complete the update.

Change Language/Double Engraving



Changing the Language

While the main menu is displayed press the “Ctrl” then the “L” keys on the keyboard. The unit will display the following screen.

Current Language is: English
Change Language to: English
Use ↑/↓ arrows to change selection.
F1: Select F10: Cancel

Use the “Arrow keys on the keys on the keyboard to scroll the “Change Language to:” field to the correct language then press “F1” to make the change.

Double Engraving

While the main menu is displayed press the “Alt” then “D” keys on the keyboard. The unit will display the following screen.

To return to single engrave press “Alt” “D” again.

You have selected to Engrave each character Twice.

Changing Fonts

While the main menu is displayed press the “F3” key on the keyboard. The unit will switch to the alternate font.

Current Tag Style: Small Circle
F1: Engrave Custom Tag
F2: Change Tag Style
F3: Font Standard

Current Tag Style: Small Circle
F1: Engrave Custom Tag
F2: Change Tag Style
F3: Font Diva

Current Font



While the main menu is displayed pressing “Ctrl” “F” will remove the Diva Font option.

Registration Information

Your serial number is located on the bottom of your PetScribe™/N'Scriber™ unit. We strongly advise you to record this number in this booklet and in a place for safe keeping in the case of damage or theft.





PetScribe™/N'Scriber™ Templates

These templates are laid out to photocopy. Supply these to clients to fill out prior to engraving custom tags.





I.D. Tag Templates

Bell Template



Engraved text will be automatically centered and sized to the maximum space available. You don't need to use all lines. Choose as many as you like, from 1 - 5

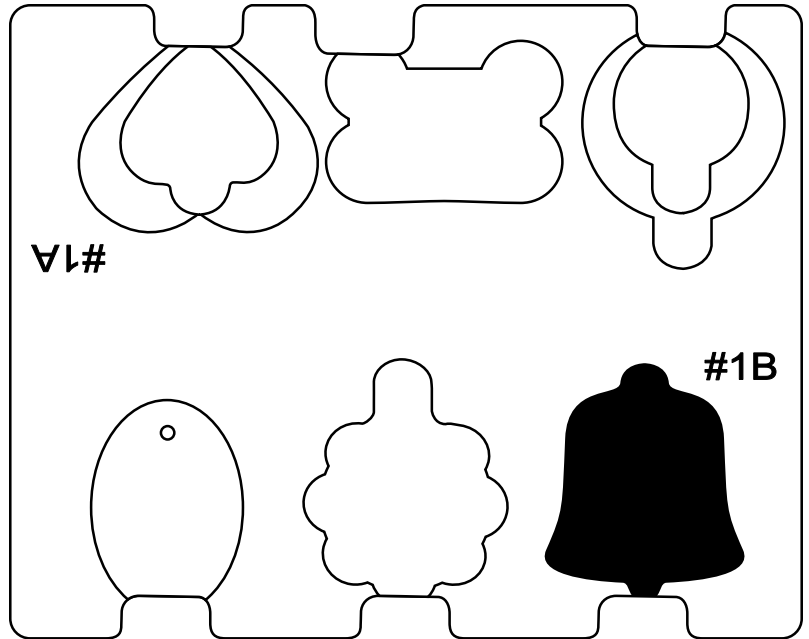

Fixture p/n 11238-01

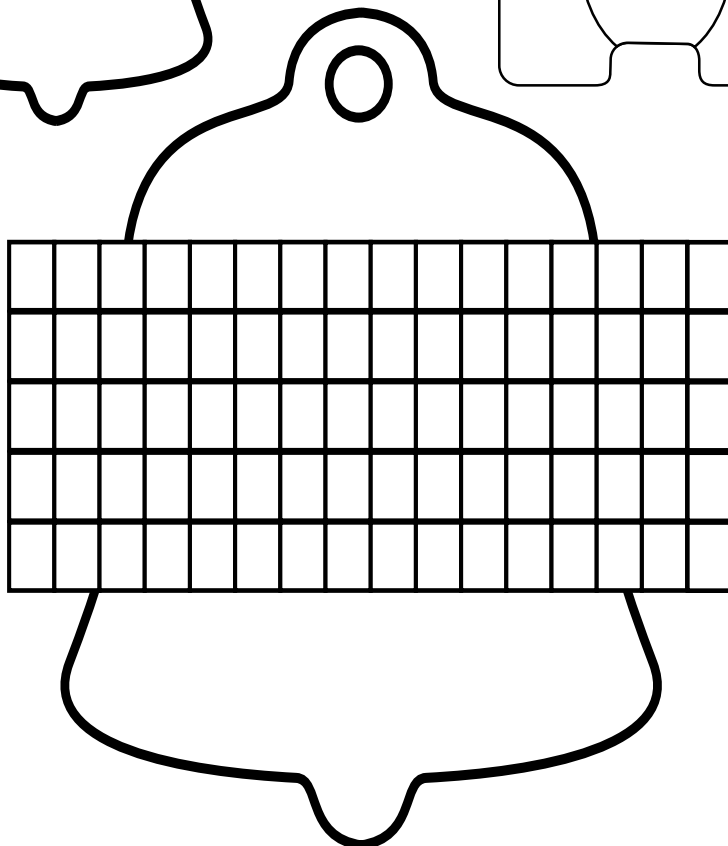

Owner: (Please Print Clearly)
Name: _____
Address: _____
City: _____ State _____ Zip _____
Phone # _____

Bone Large Template



Engraved text will be automatically centered and sized to the maximum space available. You don't need to use all lines. Choose as many as you like, from 1 - 4

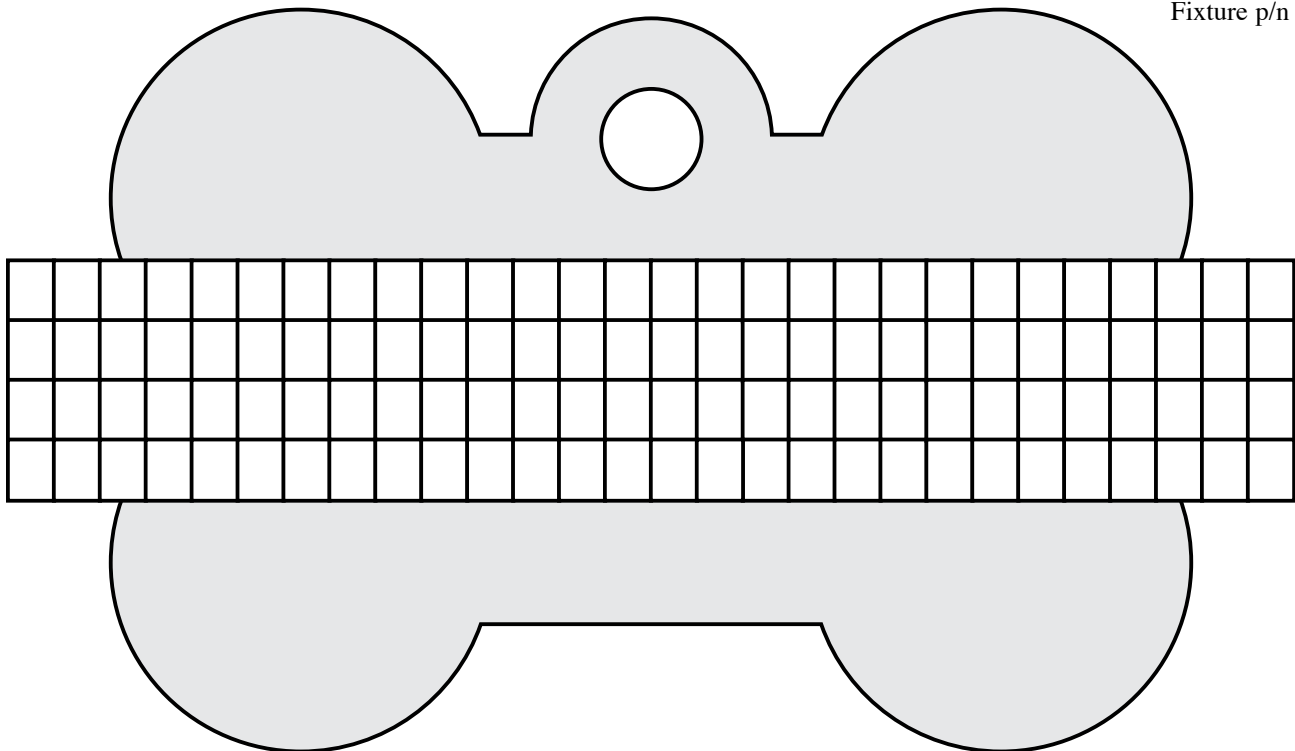
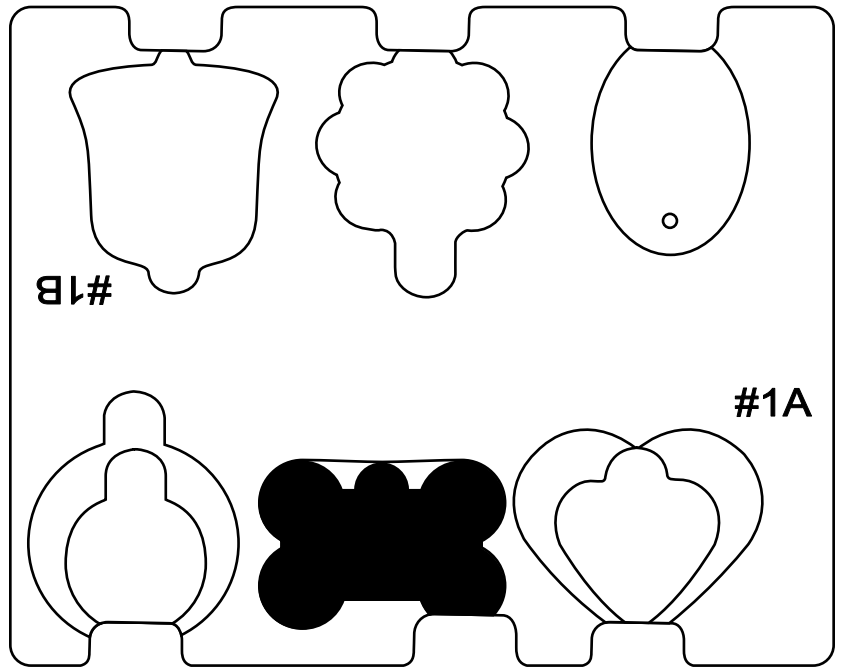

Owner: (Please Print Clearly)
Name: _____
Address: _____
City: _____ State _____ Zip _____
Phone # _____

Bone Small Template



Engraved text will be automatically centered and sized to the maximum space available. You don't need to use all lines. Choose as many as you like, from 1 - 4

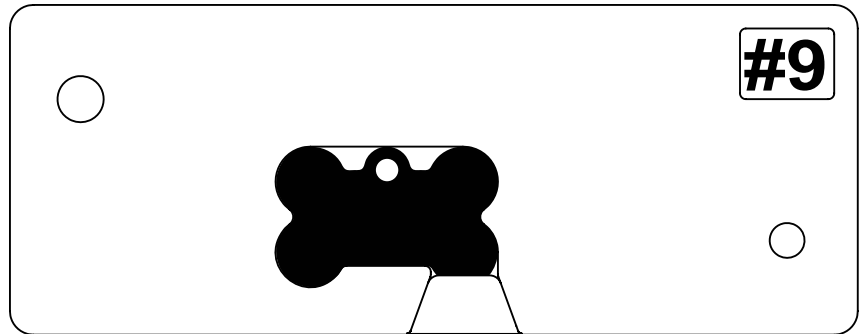

Fixture p/n 11240-07

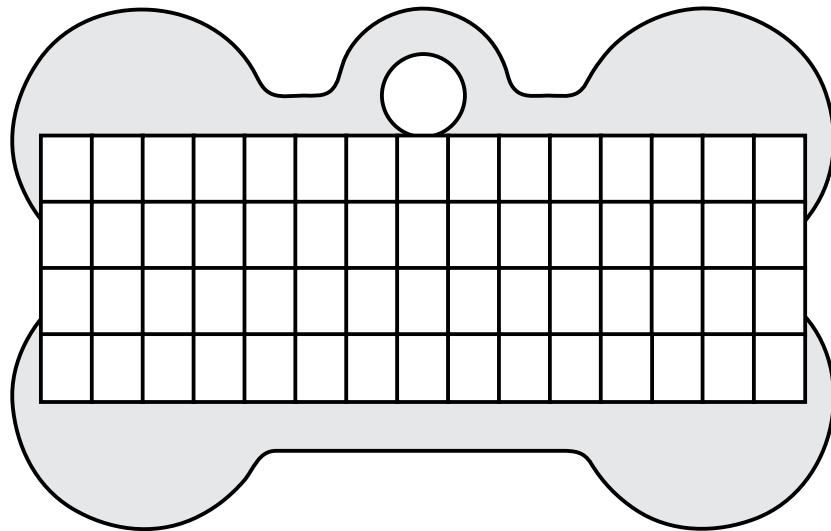

Owner: (Please Print Clearly)

Name: _____

Address: _____

City: _____ State _____ Zip _____

Phone # _____

Circle Large Template



Engraved text will be automatically centered and sized to the maximum space available. You don't need to use all lines. Choose as many as you like, from 1 - 5

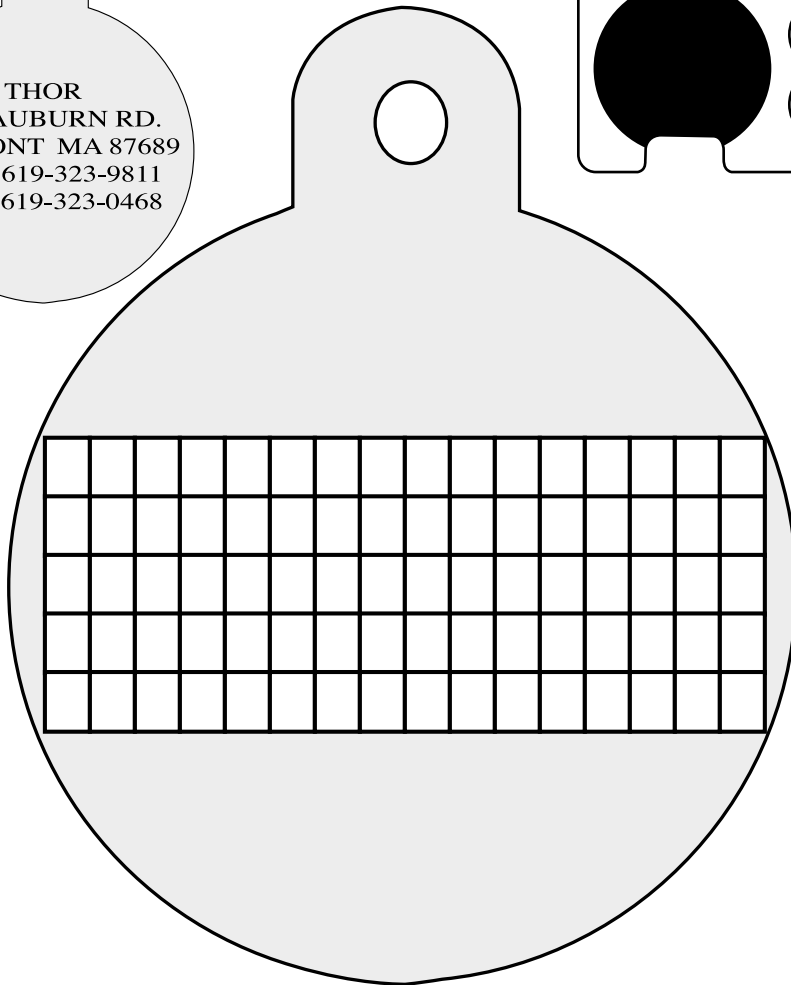
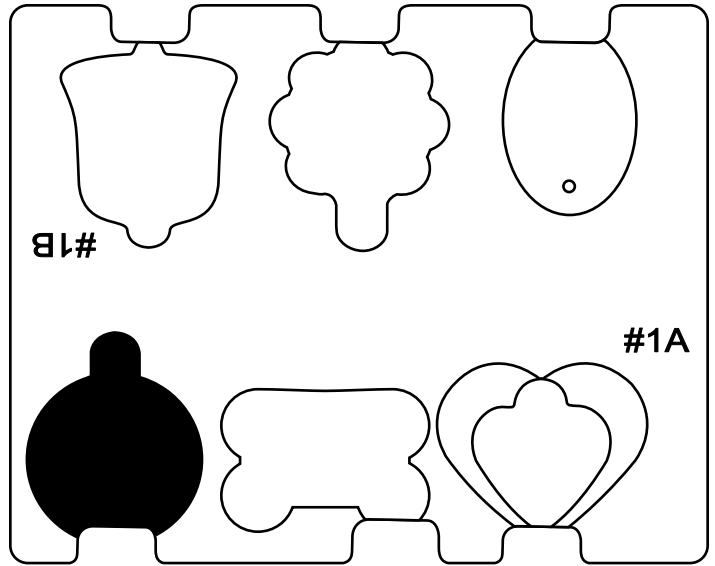

Owner: (Please Print Clearly)
Name: _____
Address: _____
City: _____ State _____ Zip _____
Phone # _____

Circle Small Template



Engraved text will be automatically centered and sized to the maximum space available. You don't need to use all lines. Choose as many as you like, from 1 - 4

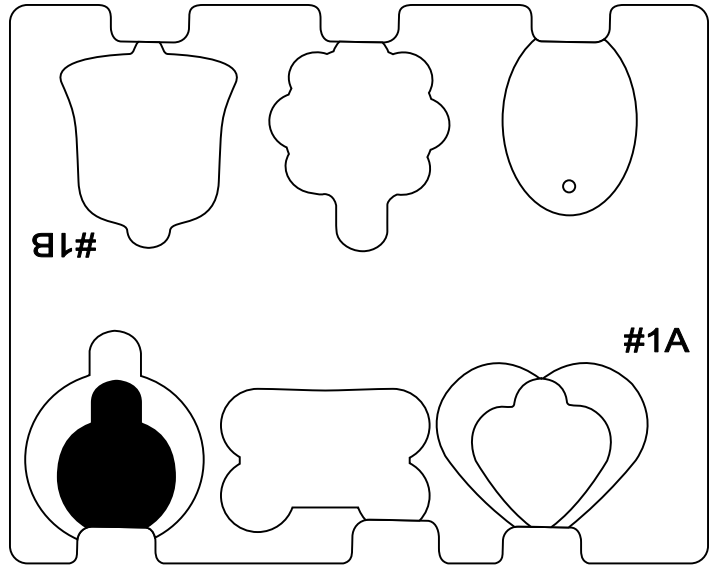

Fixture p/n 11238-01

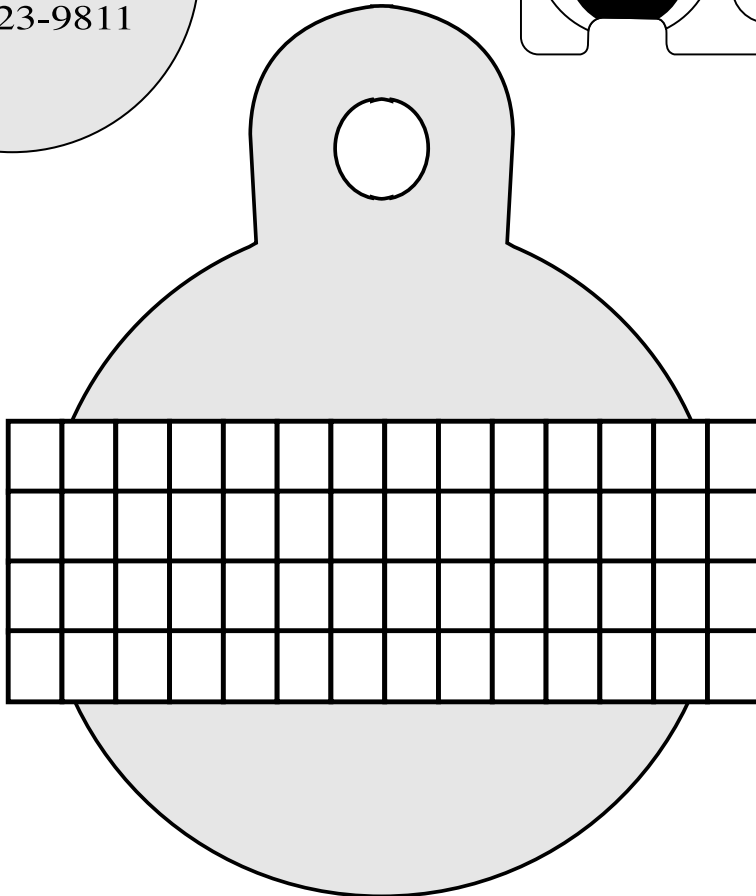

Owner: (Please Print Clearly)

Name: _____

Address: _____

City: _____ State _____ Zip _____

Phone # _____

Decorative Large Template



Engraved text will be automatically centered and sized to the maximum space available. You don't need to use all lines. Choose as many as you like, from 1 - 5

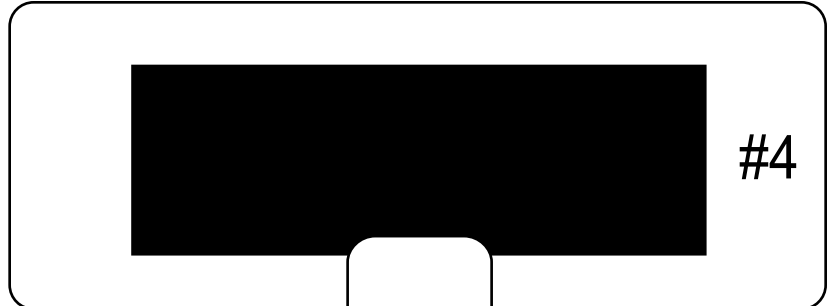

Fixture p/n 11240-03

STEVEN RANDALL
171 S. EXTENSION RD 14
TEMPE ARIZONA 85284
480-555-1234
STEVE@NETZIP.COM

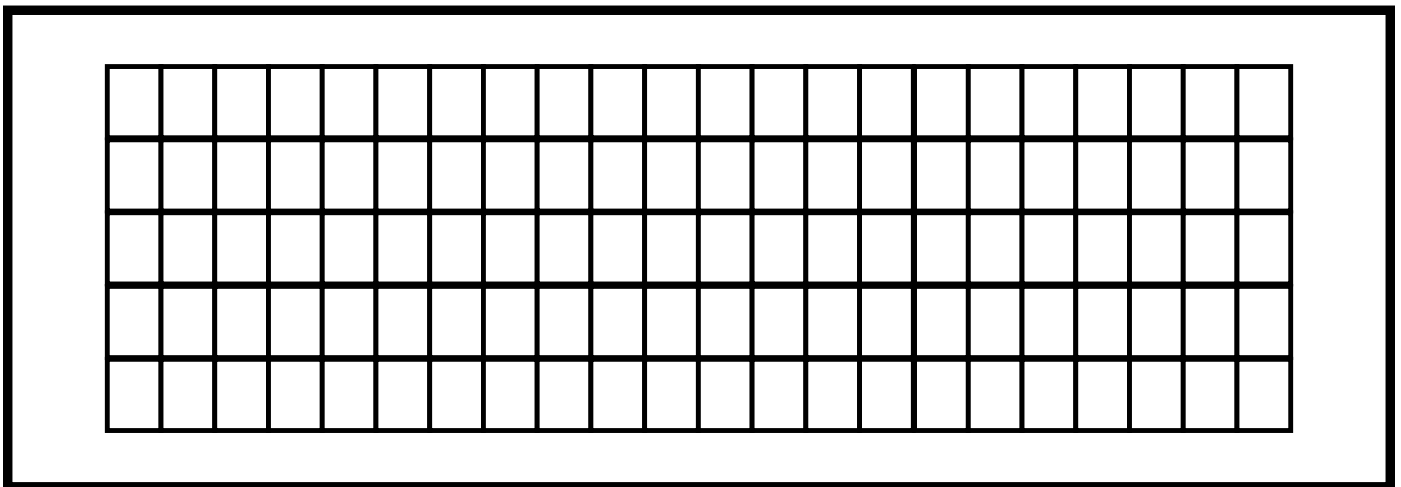

Owner: (Please Print Clearly)
Name: _____
Address: _____
City: _____ State _____ Zip _____
Phone # _____

Decorative Small Template



Engraved text will be automatically centered and sized to the maximum space available. You don't need to use all lines. Choose as many as you like, from 1 - 3

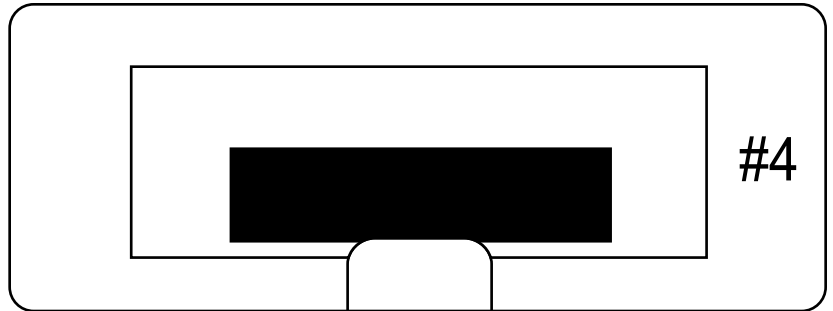

Fixture p/n 11240-03

HAPPY BIRTHDAY
09-07-2003
LOVE MOM & KIDS

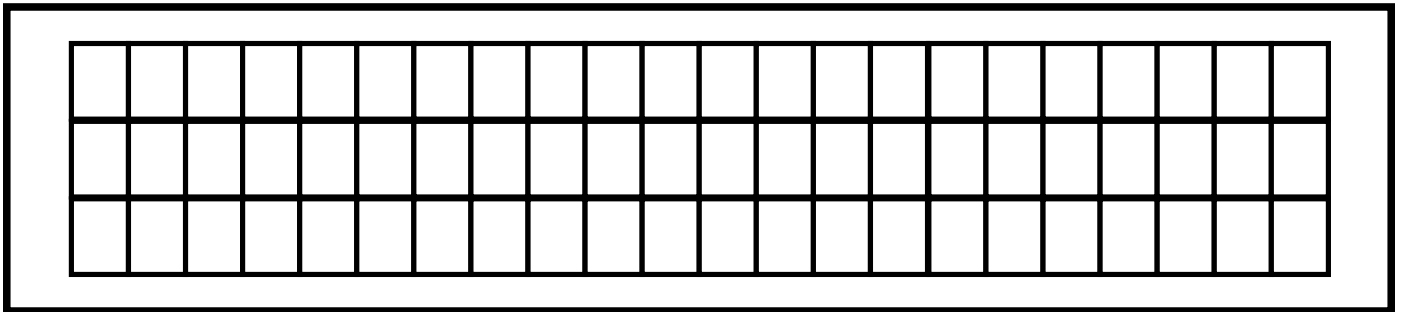

Owner: (Please Print Clearly)
Name: _____
Address: _____
City: _____ State _____ Zip _____
Phone # _____

Fire Hydrant Template



Engraved text will be automatically centered and sized to the maximum space available. You don't need to use all lines. Choose as many as you like, from 1 - 5

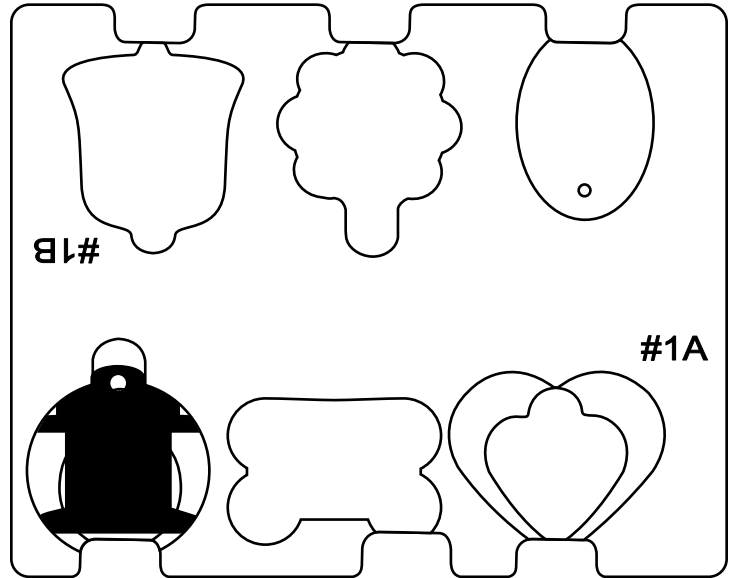

Fixture p/n 11238-01

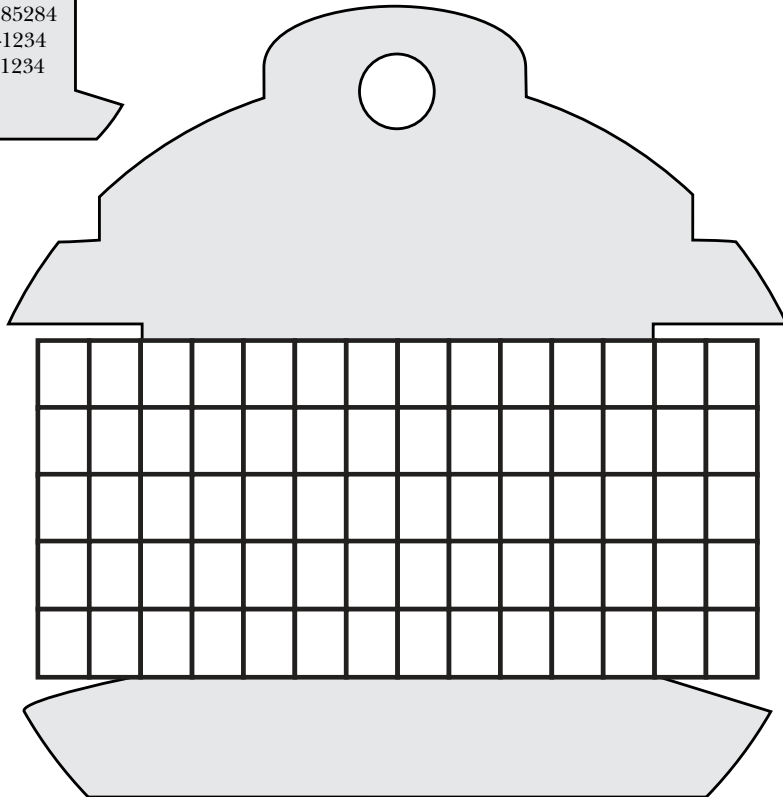

Owner: (Please Print Clearly)
Name: _____
Address: _____
City: _____ State _____ Zip _____
Phone # _____

Flashing Template



Engraved text will be automatically centered and sized to the maximum space available. You don't need to use all lines. Choose as many as you like, from 1 - 4

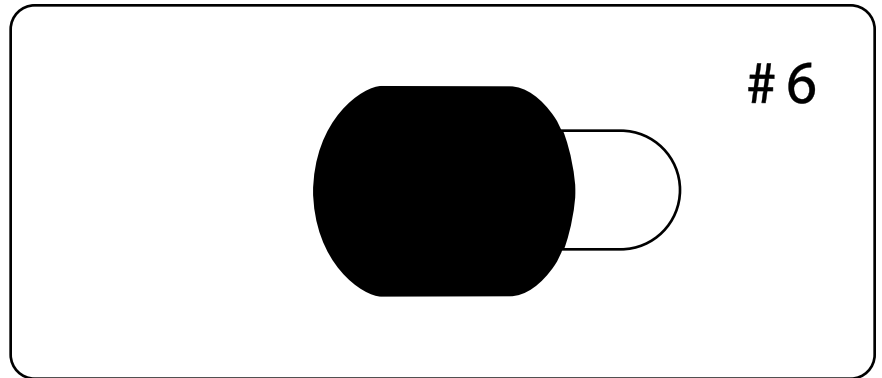

#6

Fixture p/n 11240-04

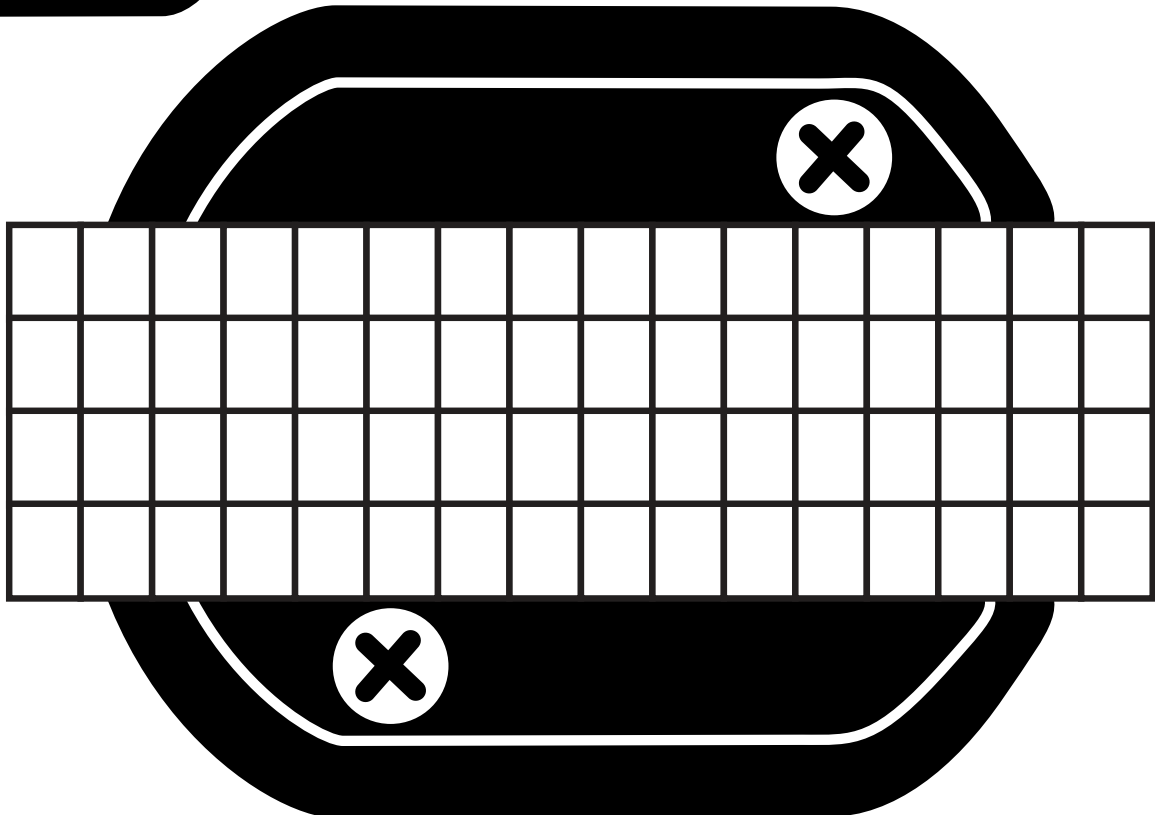

Owner: (Please Print Clearly)

Name: _____

Address: _____

City: _____ State _____ Zip _____

Phone # _____

Harley Large Template



Engraved text will be automatically centered and sized to the maximum space available. You don't need to use all lines. Choose as many as you like, from 1 - 4

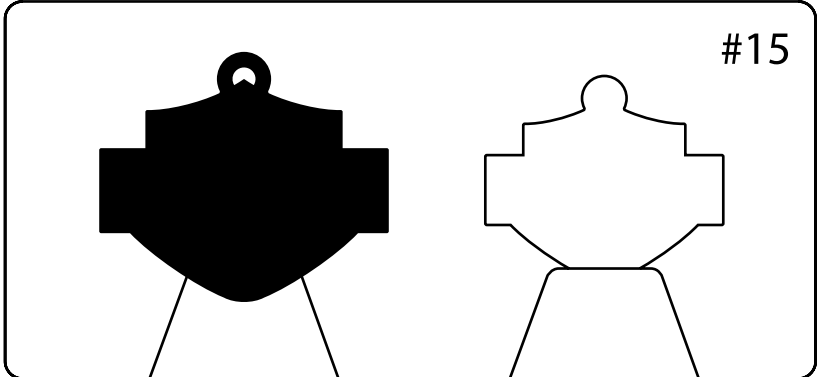

Fixture p/n 11240-11

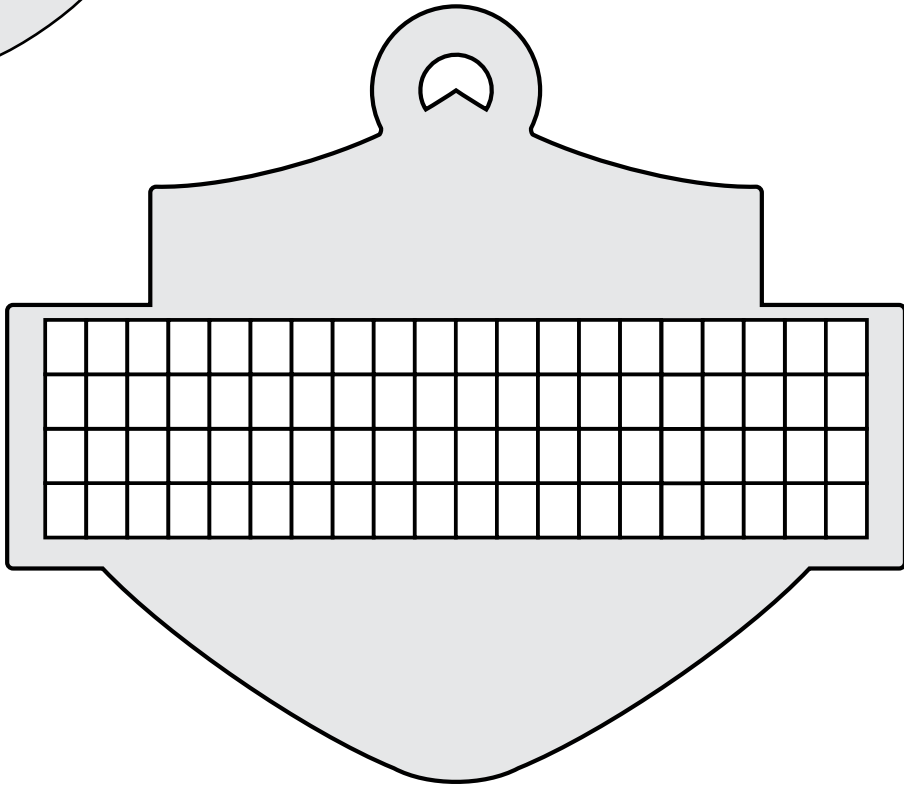

Owner: (Please Print Clearly)
Name: _____
Address: _____
City: _____ State ____ Zip _____
Phone # _____

Harley Small Template



Engraved text will be automatically centered and sized to the maximum space available. You don't need to use all lines. Choose as many as you like, from 1 - 4

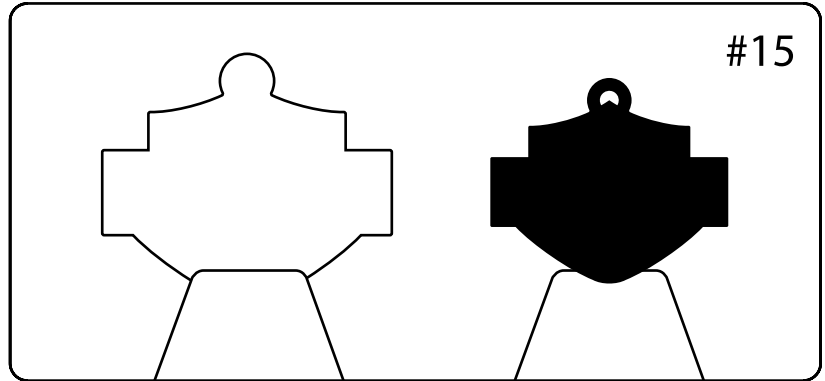

Fixture p/n 11240-11

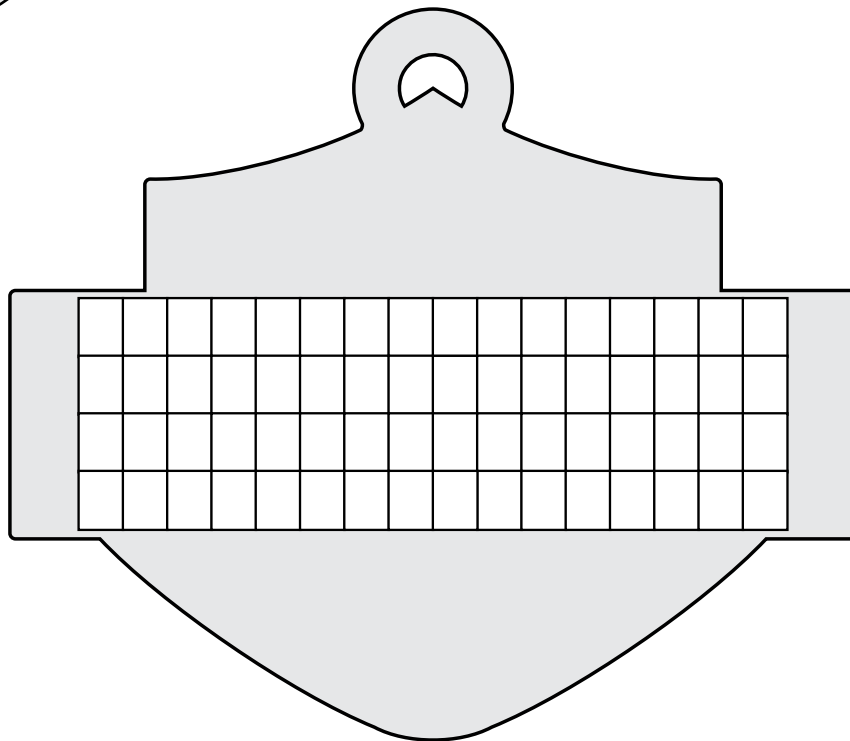

Owner: (Please Print Clearly)

Name: _____

Address: _____

City: _____ State ____ Zip _____

Phone # _____

Heart Large Template



Engraved text will be automatically centered and sized to the maximum space available. You don't need to use all lines. Choose as many as you like, from 1 - 5

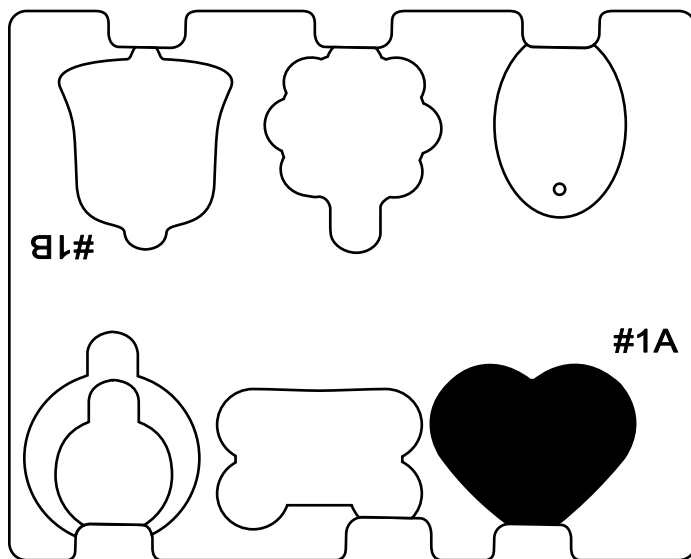

Fixture p/n 11238-01

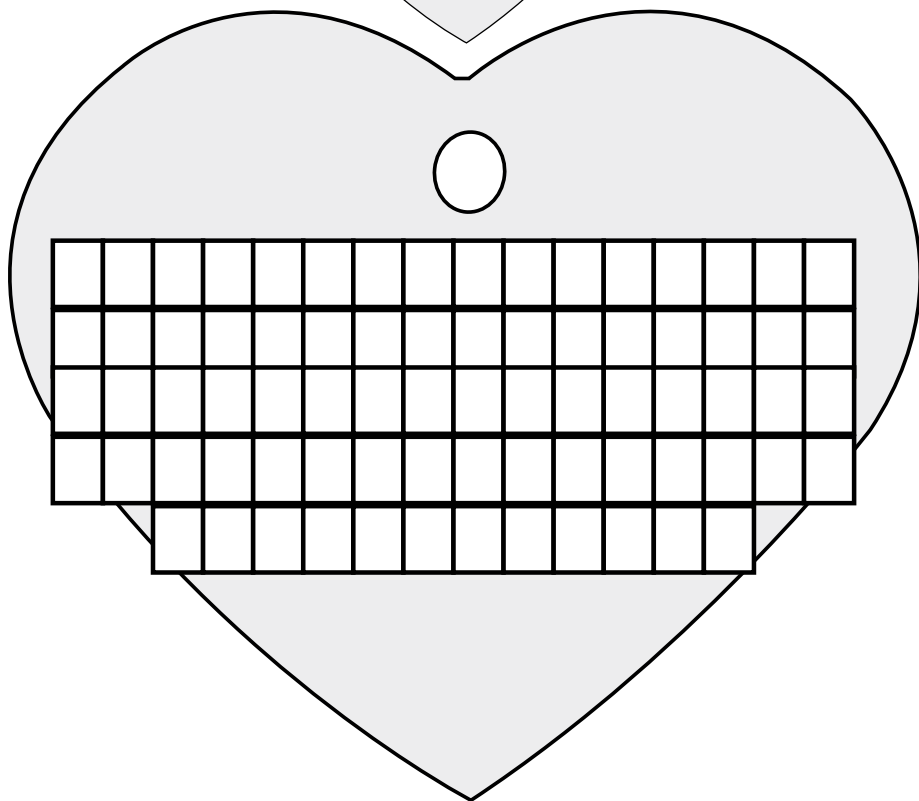

Owner: (Please Print Clearly)

Name: _____

Address: _____

City: _____ State _____ Zip _____

Phone # _____

Heart Small Template



Engraved text will be automatically centered and sized to the maximum space available. You don't need to use all lines. Choose as many as you like, from 1 - 4

Owner: (Please Print Clearly)

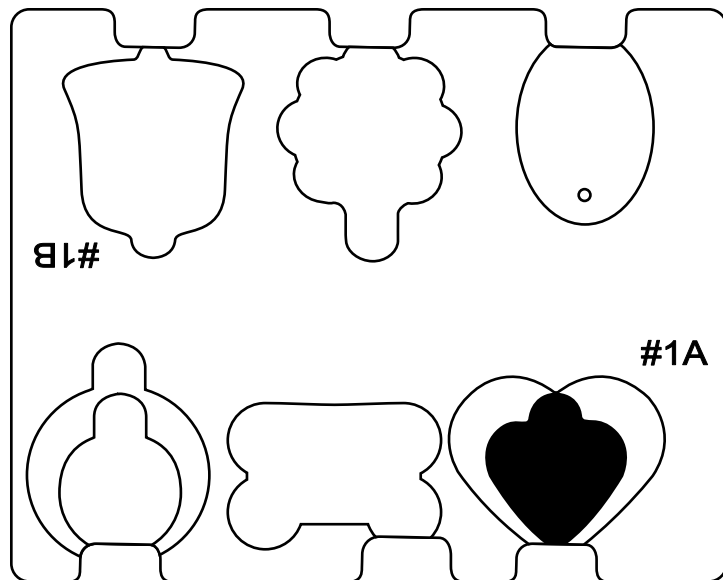

Fixture p/n 11238-01

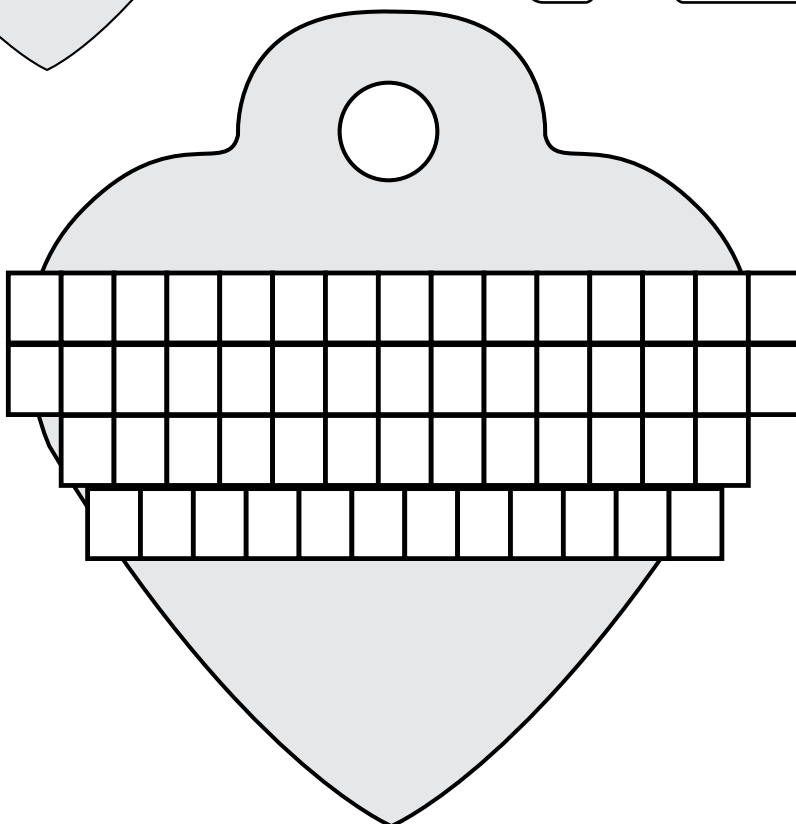

Name: _____

Address: _____

City: _____ State _____ Zip _____

Phone # _____

Diva Jewelry Circle Template



Engraved text will be automatically centered and sized to the maximum space available. You don't need to use all lines. Choose as many as you like, from 1 - 4

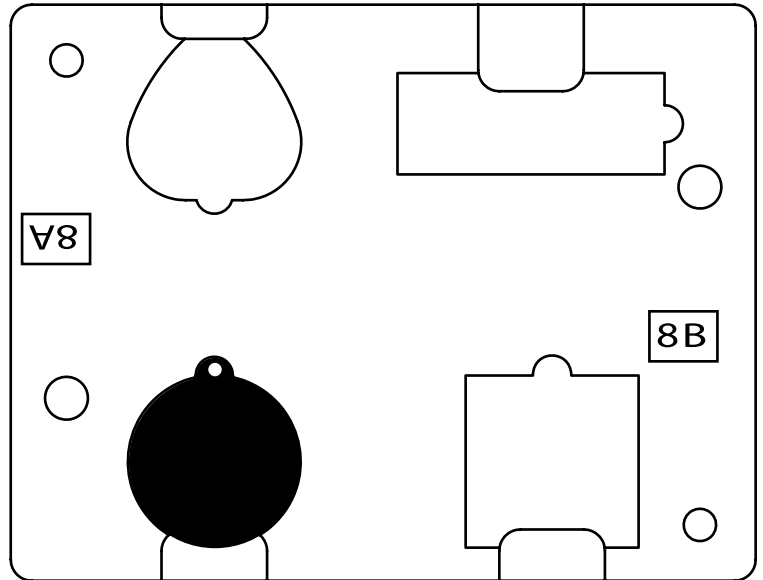

Fixture p/n 11238-07

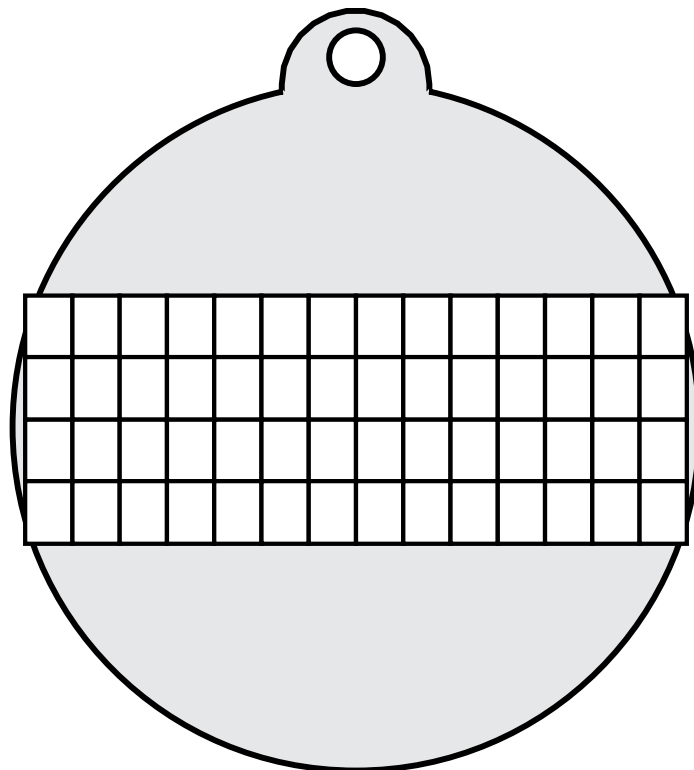

Owner: (Please Print Clearly)
Name: _____
Address: _____
City: _____ State _____ Zip _____
Phone # _____

Diva Jewelry Heart Template



Engraved text will be automatically centered and sized to the maximum space available. You don't need to use all lines. Choose as many as you like, from 1 - 4

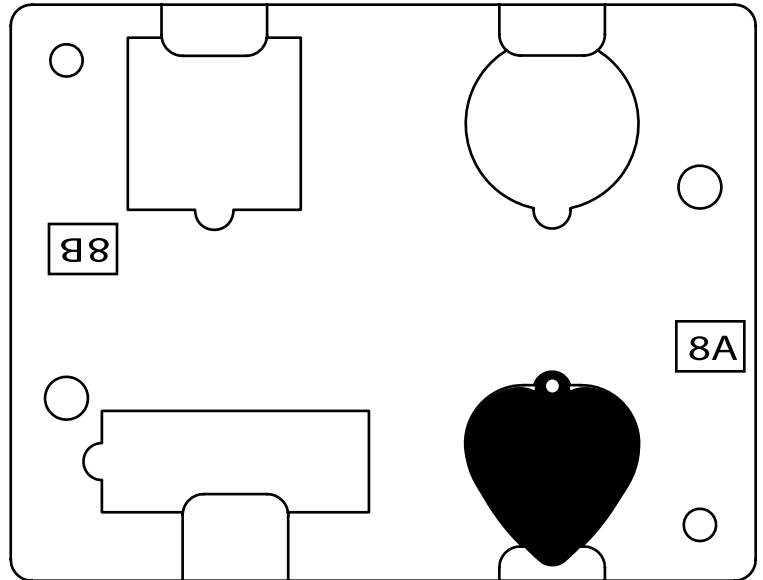

Fixture p/n 11238-07

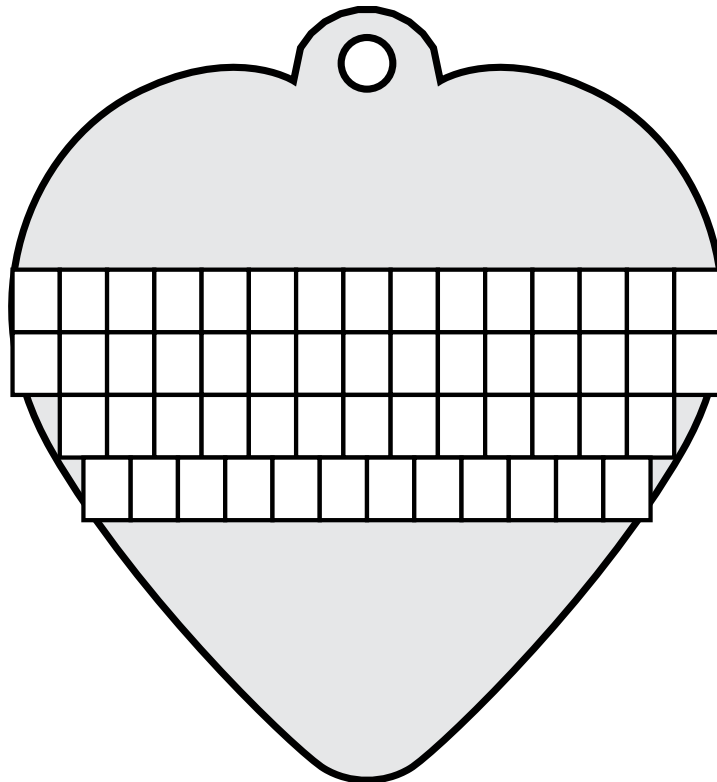

Owner: (Please Print Clearly)

Name: _____

Address: _____

City: _____ State _____ Zip _____

Phone # _____

Diva Jewelry Rectangle Template



Engraved text will be automatically centered and sized to the maximum space available.

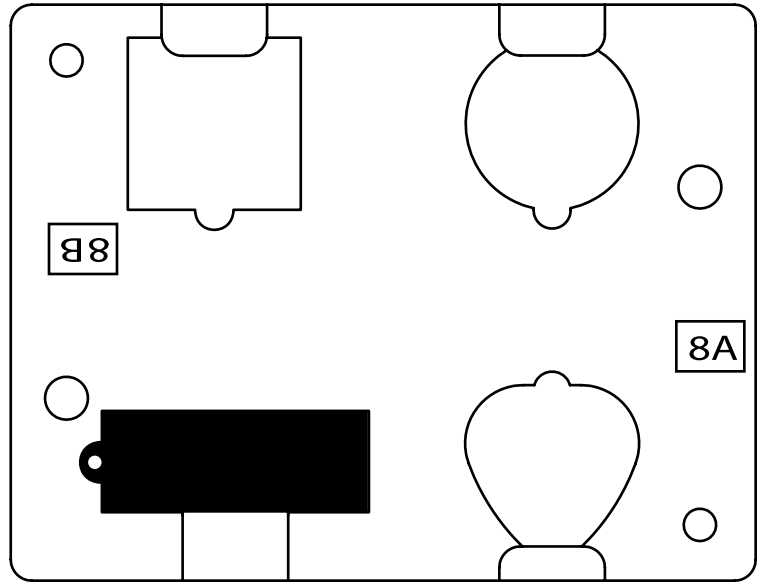
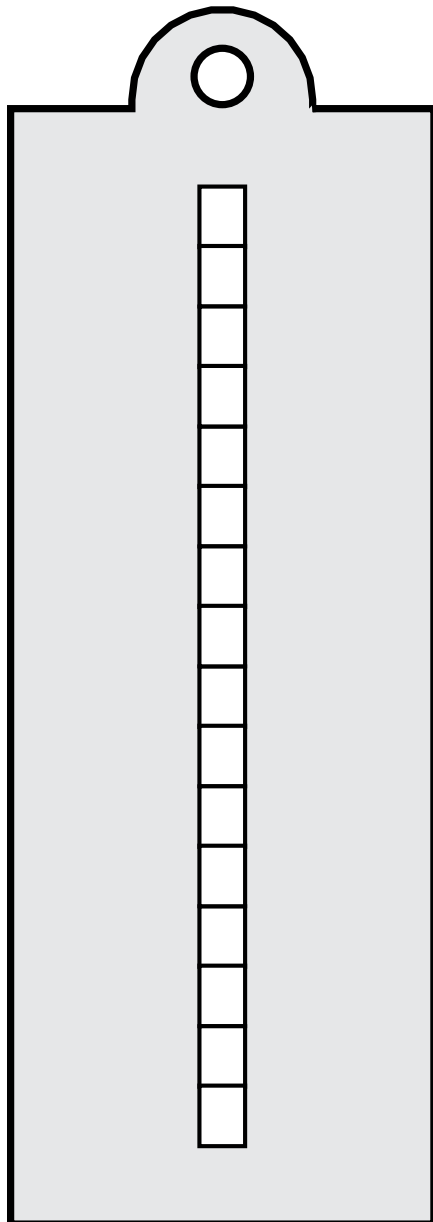

Fixture p/n 11238-07

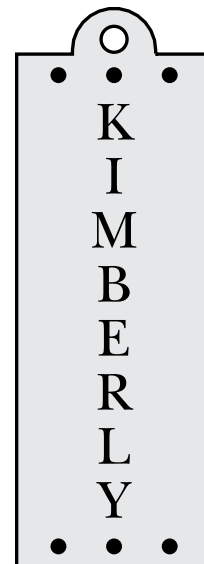

Owner: (Please Print Clearly)
Name: _____
Address: _____
City: _____ State _____ Zip _____
Phone # _____

Diva Jewelry Square Template



Engraved text will be automatically centered and sized to the maximum space available. You don't need to use all lines. Choose as many as you like, from 1 - 4

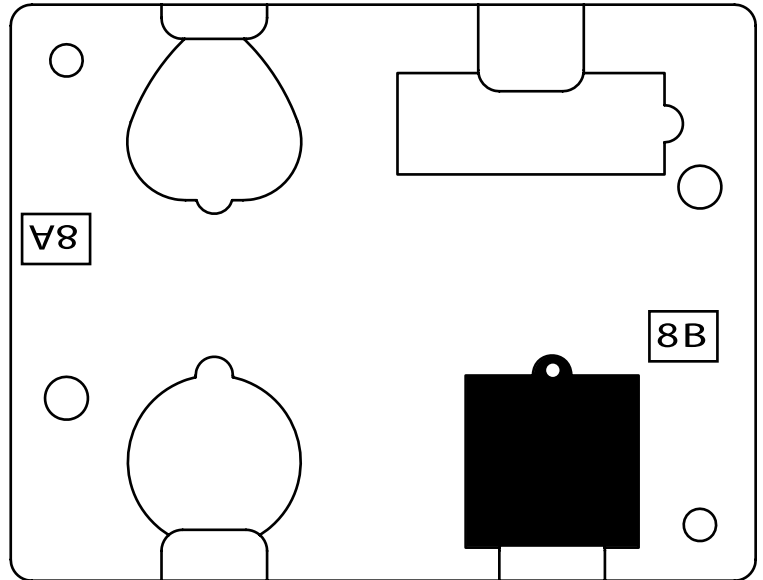
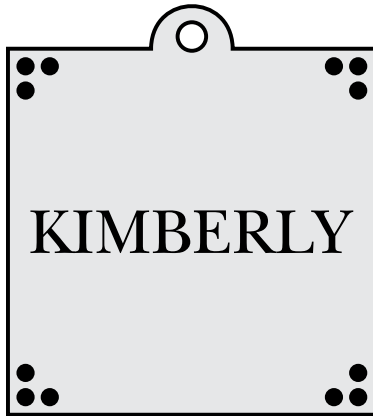

Fixture p/n 11238-07

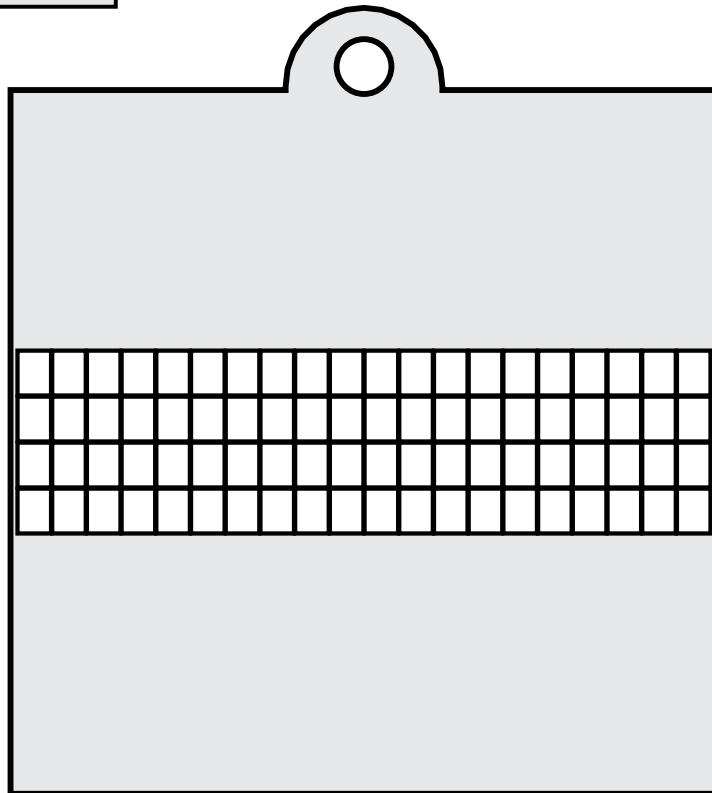

Owner: (Please Print Clearly)
Name: _____
Address: _____
City: _____ State _____ Zip _____
Phone # _____

Luggage Template



Engraved text will be automatically centered and sized to the maximum space available. You don't need to use all lines. Choose as many as you like, from 1 - 5

STEVEN RANDALL
 171 S. EXTENSION RD 14
 TEMPE ARIZONA 85284
 480-555-1234
 STEVE@NETZIP.COM

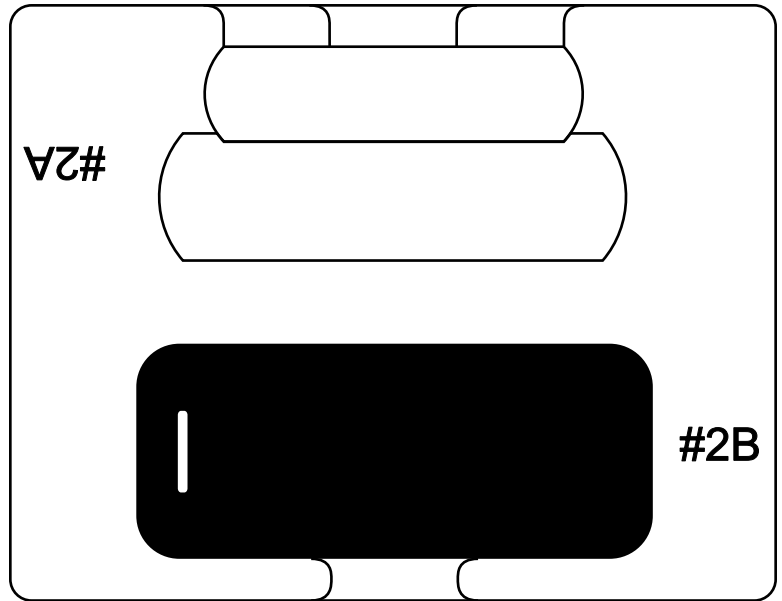

Fixture p/n 11238-02

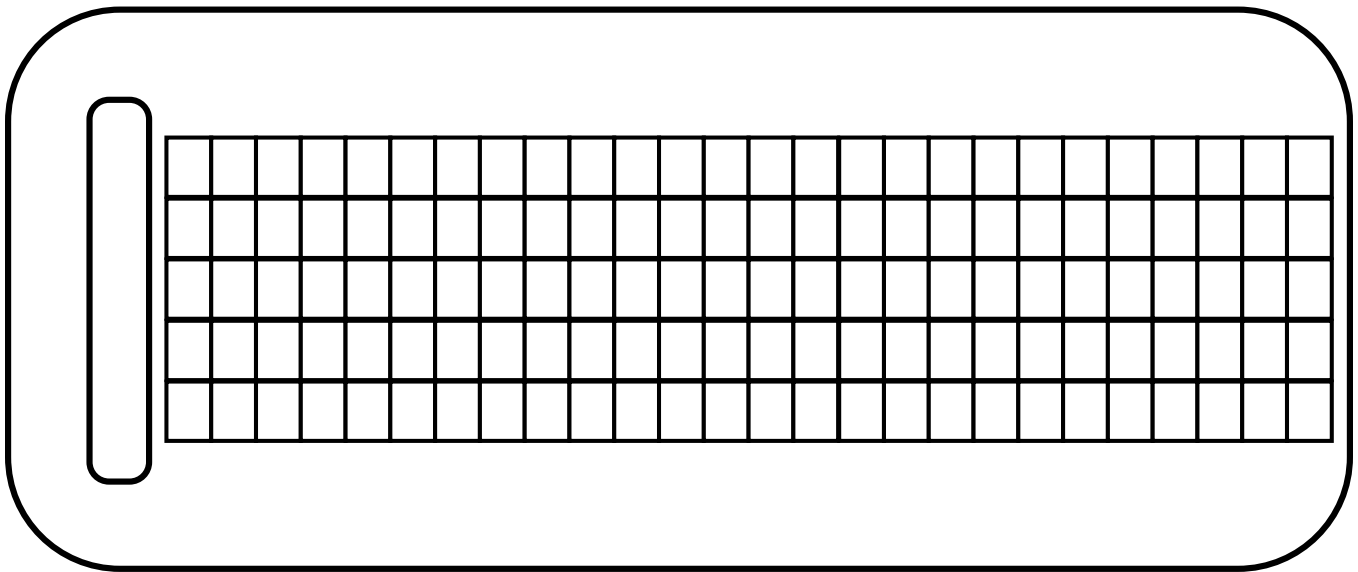

Owner: (Please Print Clearly)

Name: _____

Address: _____

City: _____ State _____ Zip _____

Phone # _____

Military Large Template



Engraved text will be automatically centered and sized to the maximum space available. You don't need to use all lines. Choose as many as you like, from 1 - 5

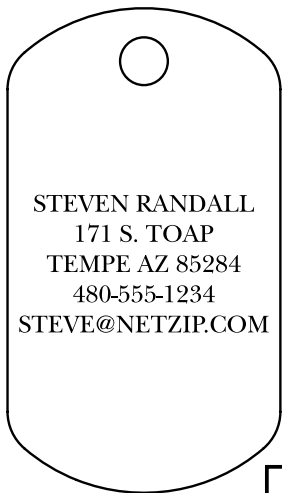

Vertical

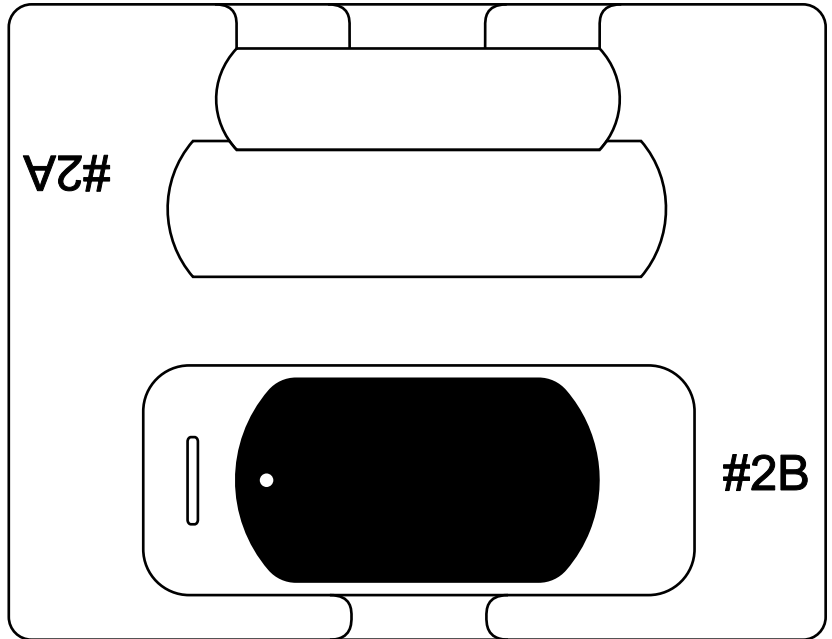

Fixture p/n 11238-02

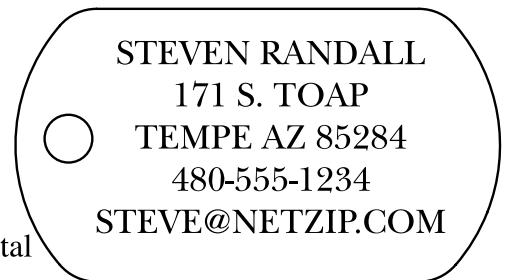
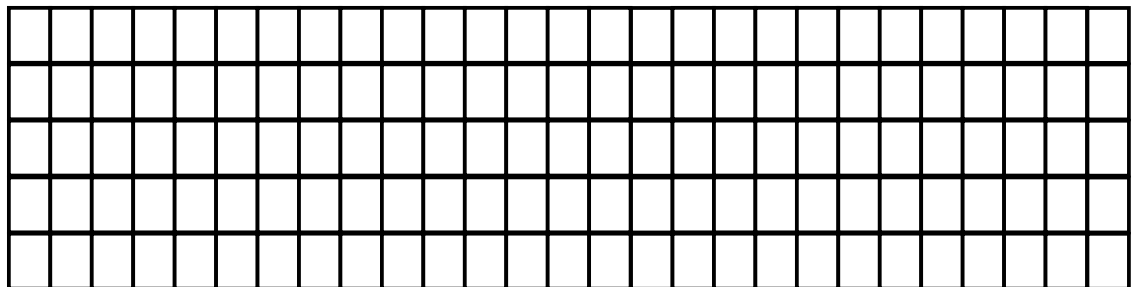

Horizontal

Please Select Vertical Horizontal

Owner: (Please Print Clearly)

Name: _____

Address: _____

City: _____ State _____ Zip _____

Phone # _____

Military Small Template



Engraved text will be automatically centered and sized to the maximum space available. You don't need to use all lines. Choose as many as you like, from 1 - 5

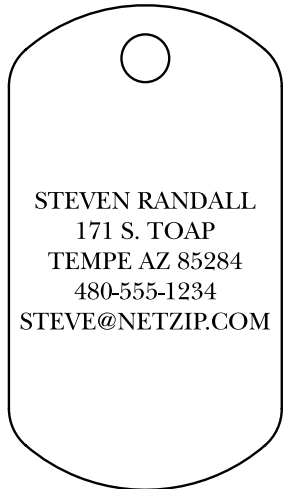

Vertical

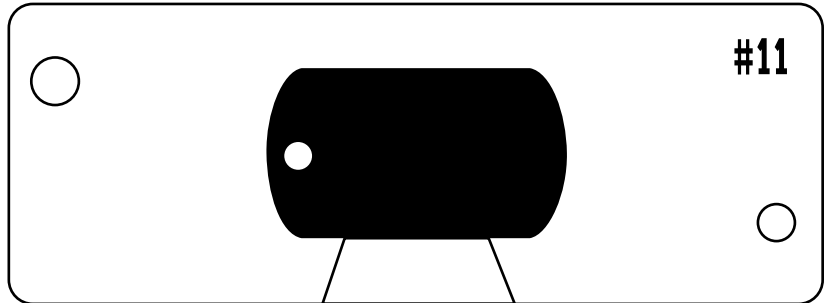

Fixture p/n 11240-08

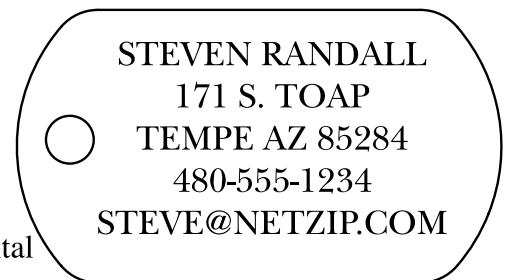
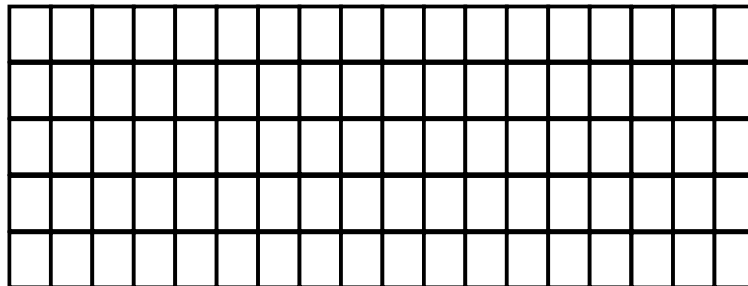

Horizontal

Owner: (Please Print Clearly)

Name: _____

Address: _____

City: _____ State _____ Zip _____

Phone # _____

Ornament Template



Engraved text will be automatically centered and sized to the maximum space available. You don't need to use all lines. Choose as many as you like, from 1 - 4

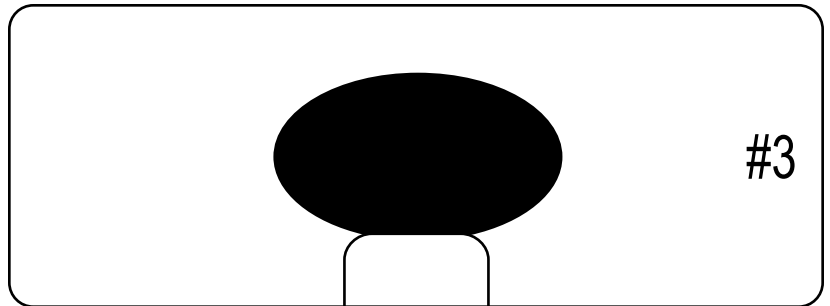

Fixture p/n 11240-02

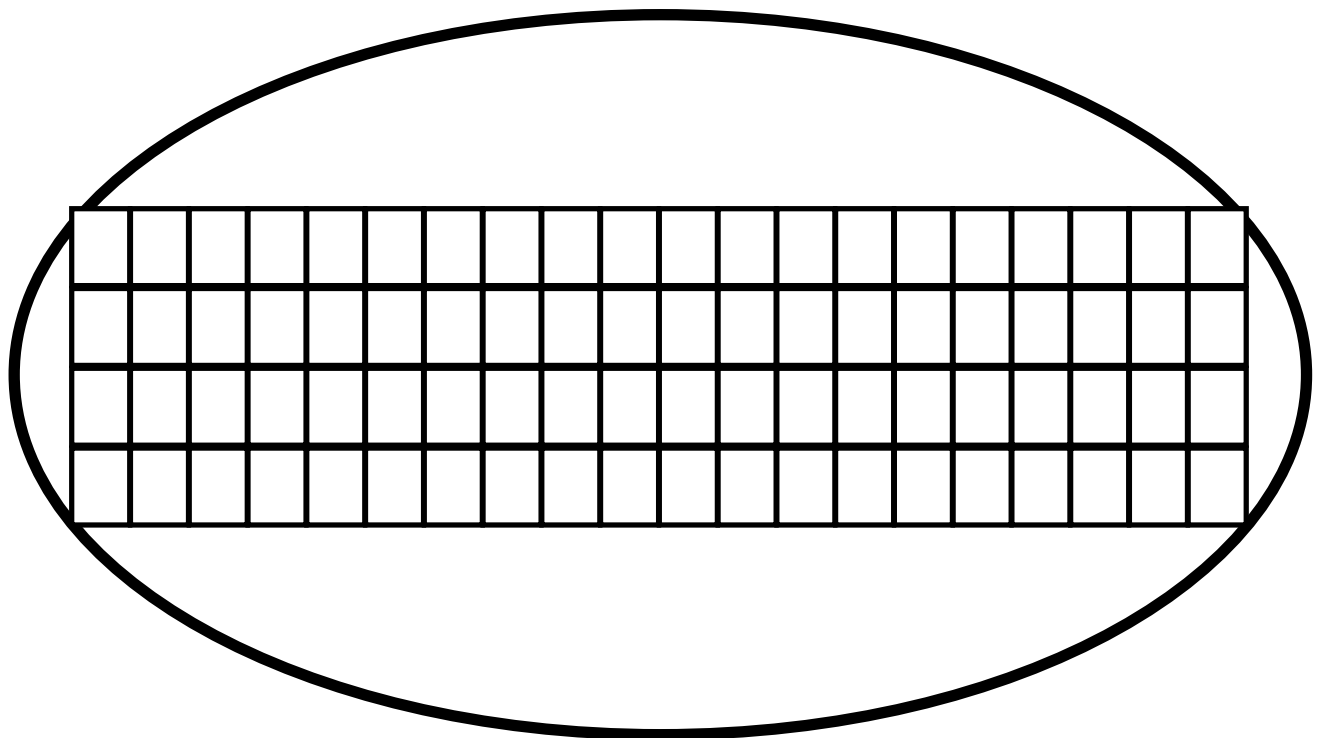

Owner: (Please Print Clearly)
Name: _____
Address: _____
City: _____ State _____ Zip _____
Phone # _____

Oval Template



Engraved text will be automatically centered and sized to the maximum space available. You don't need to use all lines. Choose as many as you like, from 1 - 5



Vertical

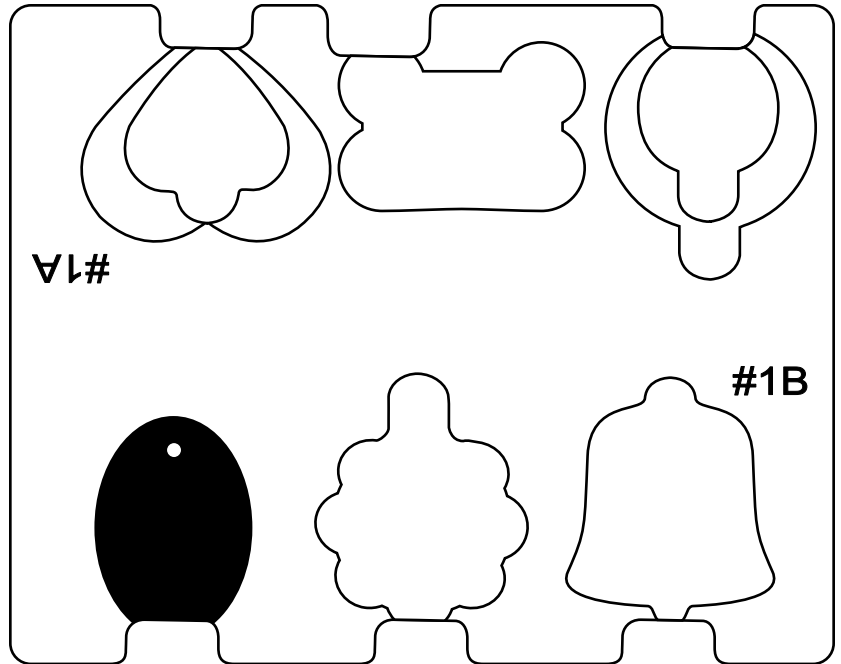

Fixture p/n 11238-01

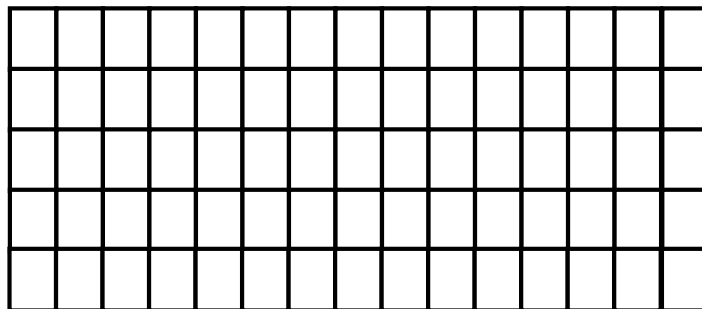

Horizontal

Please Select Vertical Horizontal

Owner: (Please Print Clearly)

Name: _____

Address: _____

City: _____ State _____ Zip _____

Phone # _____

Rivet Large Template



Engraved text will be automatically centered and sized to the maximum space available. You don't need to use all lines. Choose as many as you like, from 1 - 4

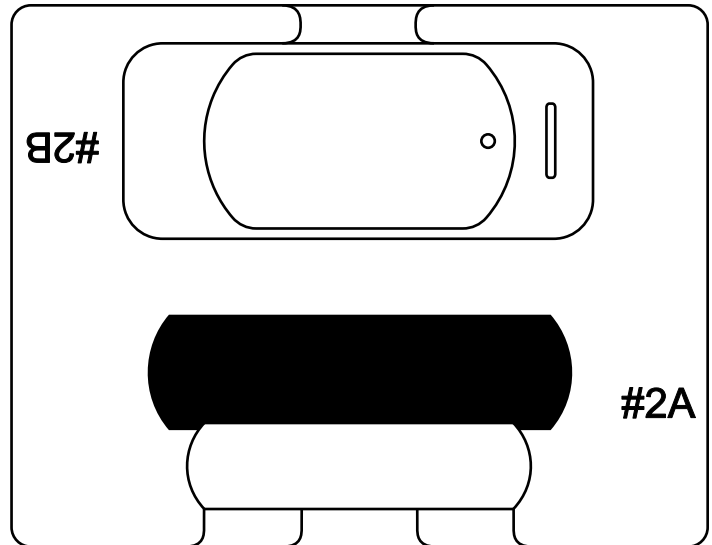

Fixture p/n 11238-02

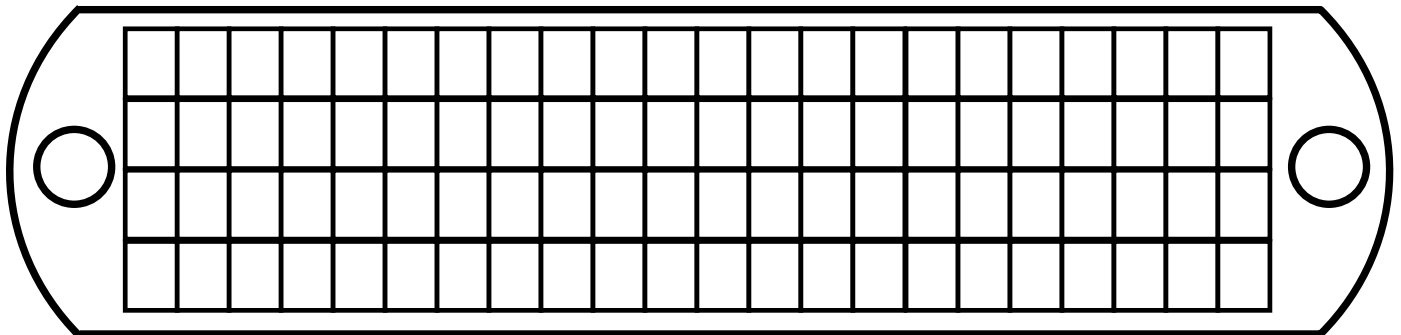

Owner: (Please Print Clearly)

Name: _____

Address: _____

City: _____ State _____ Zip _____

Phone # _____

Rivet Small Template



Engraved text will be automatically centered and sized to the maximum space available. You don't need to use all lines. Choose as many as you like, from 1 - 3

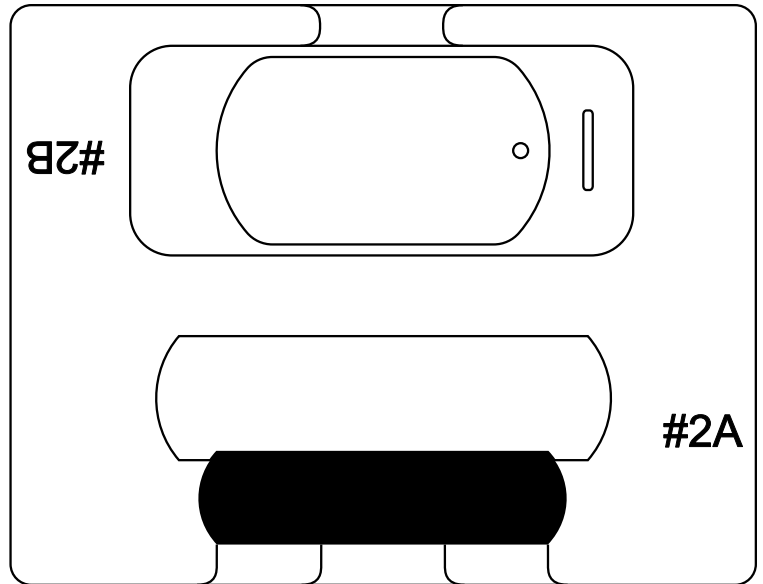

Fixture p/n 11238-02

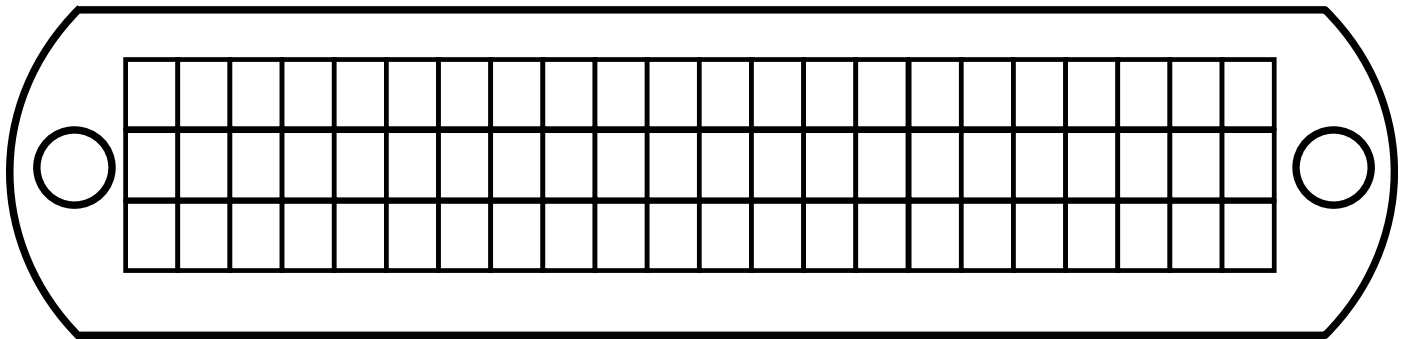
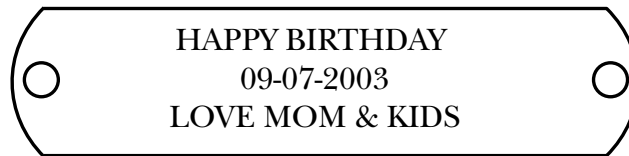

Owner: (Please Print Clearly)
Name: _____
Address: _____
City: _____ State _____ Zip _____
Phone # _____

Rosette Template



Engraved text will be automatically centered and sized to the maximum space available. You don't need to use all lines. Choose as many as you like, from 1 - 5

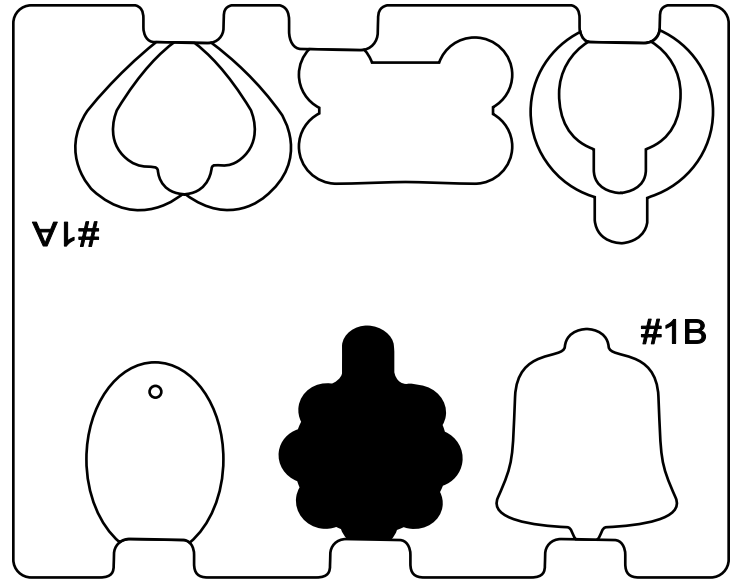

Fixture p/n 11238-01

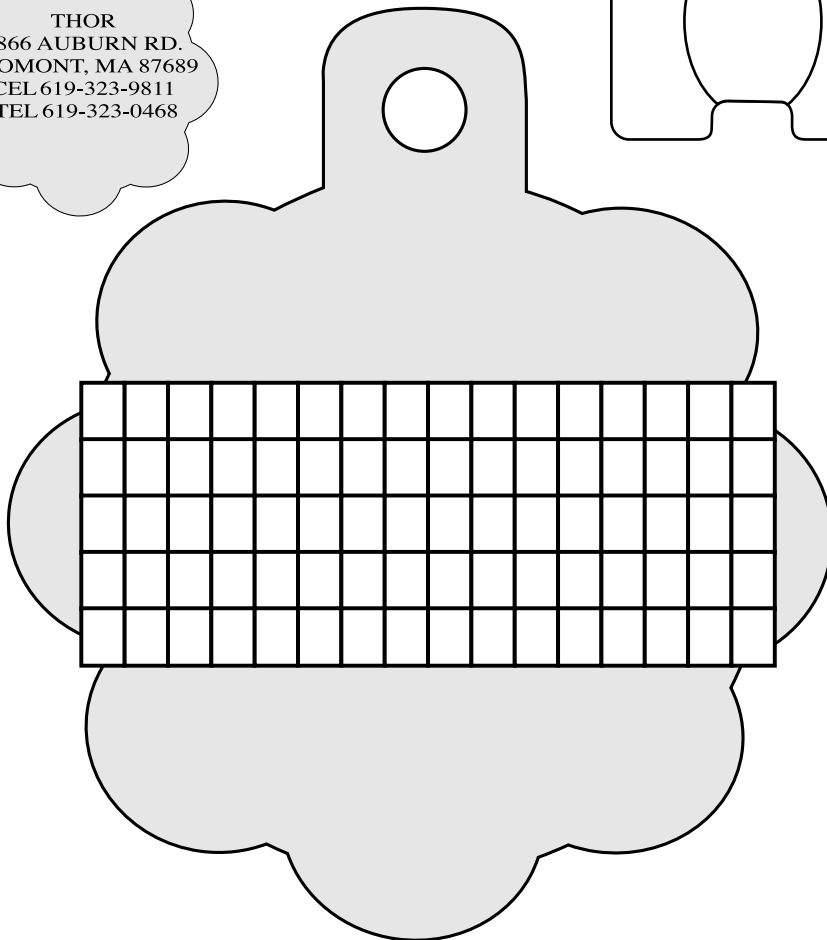

Owner: (Please Print Clearly)
Name: _____
Address: _____
City: _____ State _____ Zip _____
Phone # _____

Stall Plate Template



Engraved text will be automatically centered and sized to the maximum space available. You don't need to use all lines. Choose as many as you like, from 1 - 5

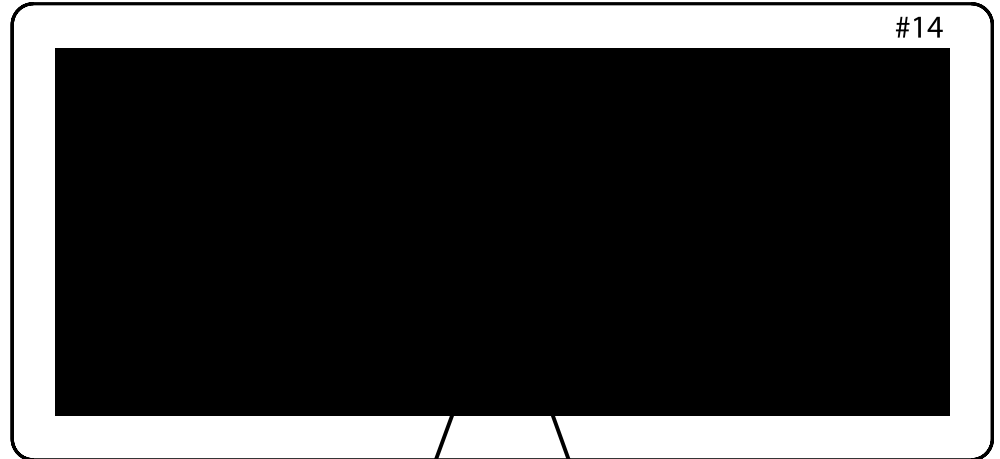

Fixture p/n 11240-14

CHARLIE
OWNER: THOMAS SMITH
TRAINER: DAVID MACHOL

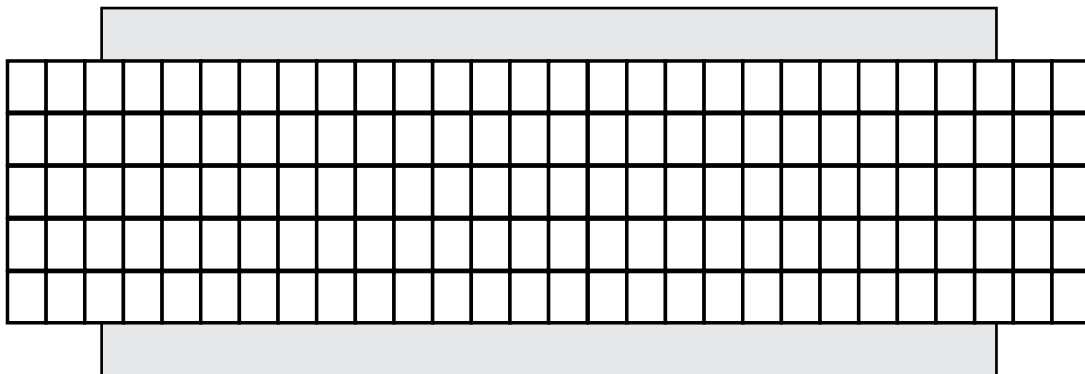

Owner: (Please Print Clearly)
Name: _____
Address: _____
City: _____ State _____ Zip _____
Phone # _____



Key Templates

KW1/KW11 Key Template



Engraved text will be automatically centered and sized to the maximum space available. You don't need to use all lines. Choose as many as you like, from 1 - 2

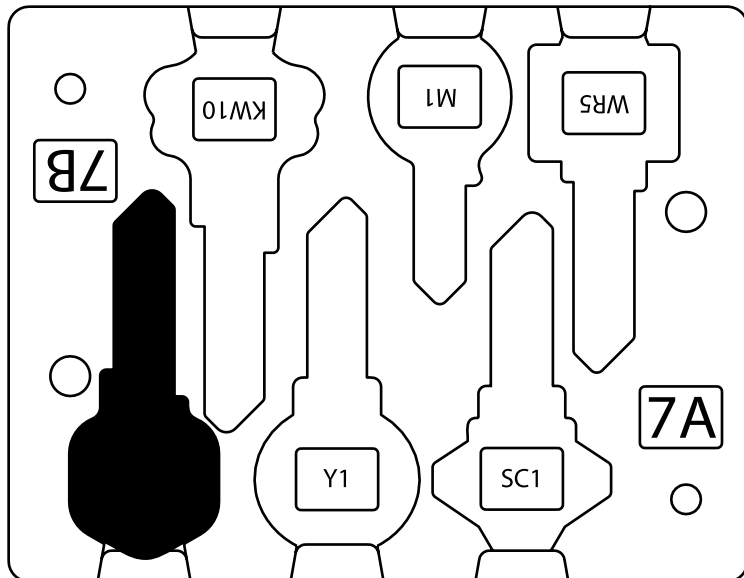
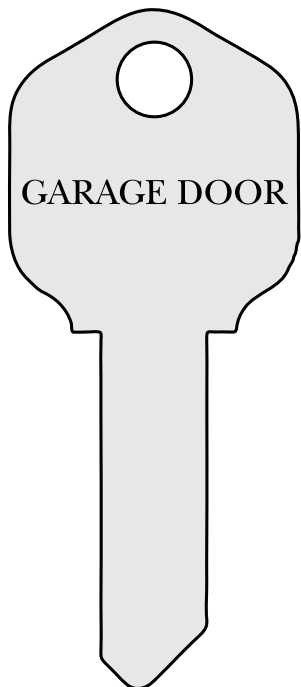

Fixture p/n 11240-06

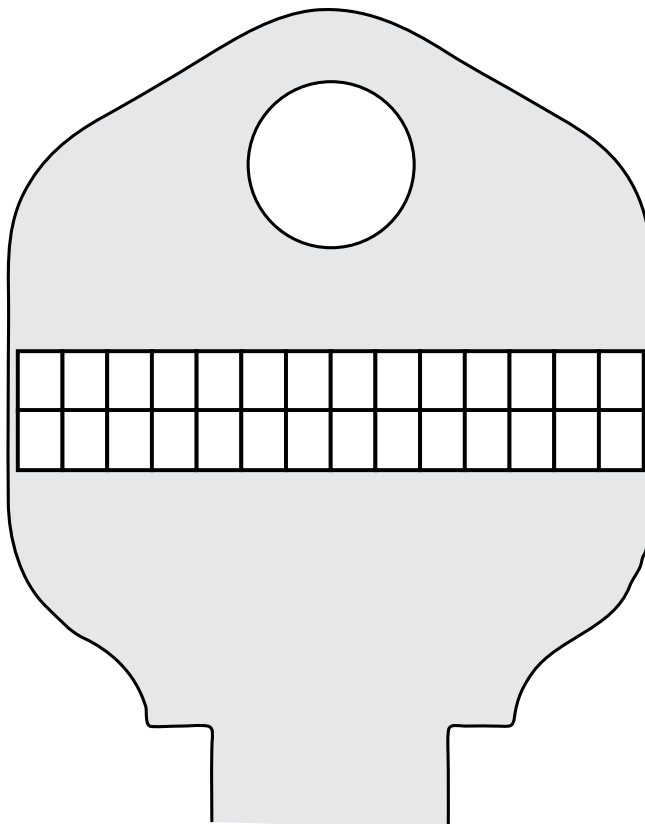

Owner: (Please Print Clearly)
Name: _____
Address: _____
City: _____ State _____ Zip _____
Phone # _____

Note: Use only Hillman brand keys.
Place key into carrier with the blank side up.

KW10 Key Template



Engraved text will be automatically centered and sized to the maximum space available. You don't need to use all lines. Choose as many as you like, from 1 - 2

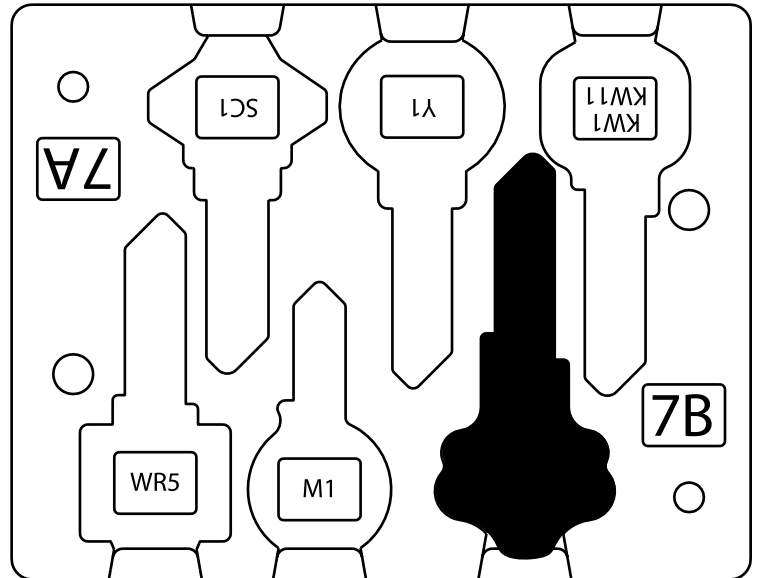
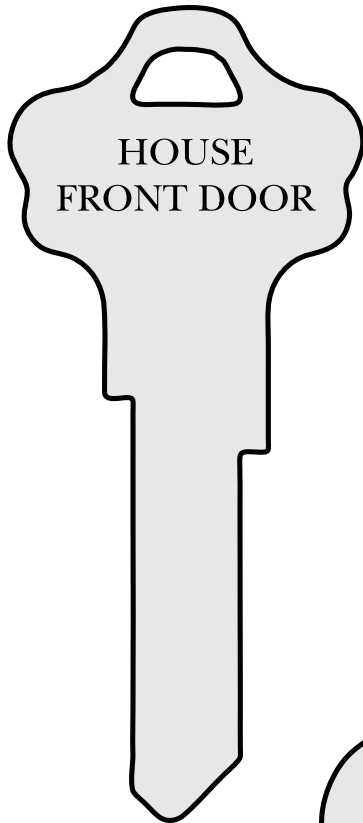

Fixture p/n 11240-06

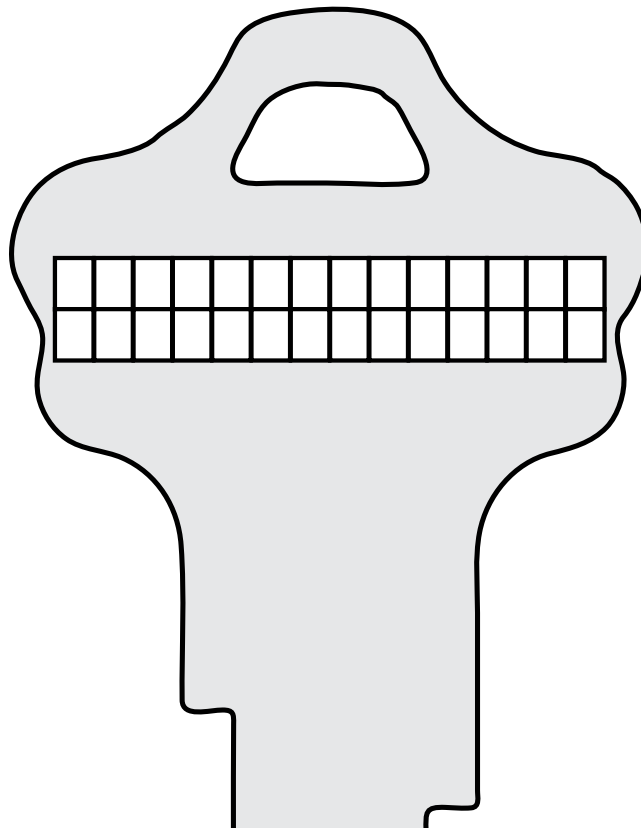

Owner: (Please Print Clearly)
Name: _____
Address: _____
City: _____ State _____ Zip _____
Phone # _____

Note: Use only Hillman brand keys.
Place key into carrier with the blank side up.

M1 Key Template



Engraved text will be automatically centered and sized to the maximum space available. You don't need to use all lines. Choose as many as you like, from 1 - 2

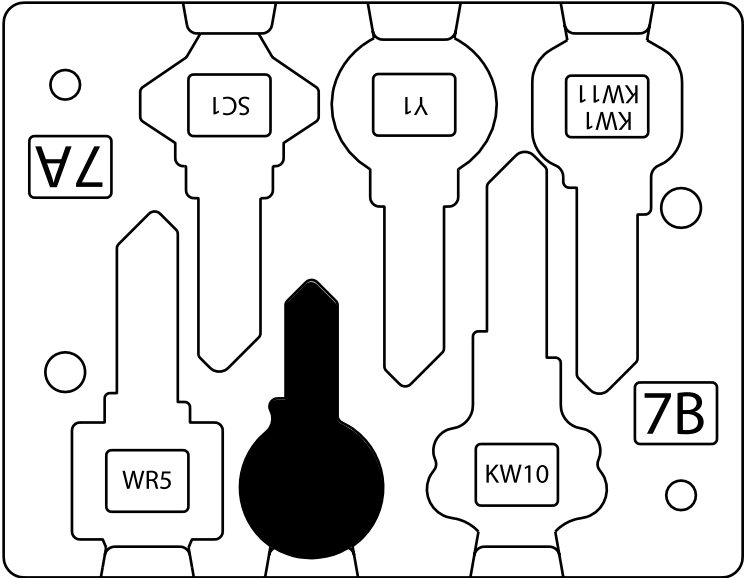

Fixture p/n 11240-06

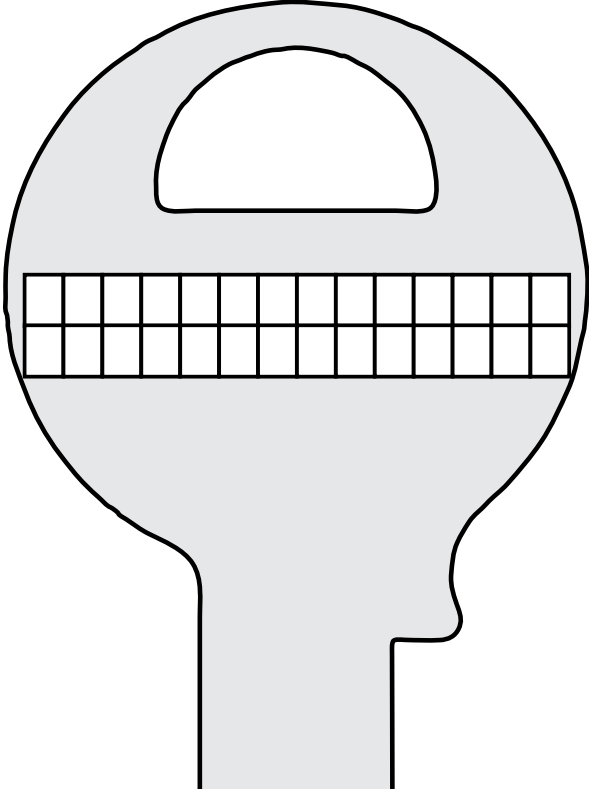

Owner: (Please Print Clearly)
Name: _____
Address: _____
City: _____ State _____ Zip _____
Phone # _____

Note: Use only Hillman brand keys.
Place key into carrier with the blank side up.

SC1 Key Template



Engraved text will be automatically centered and sized to the maximum space available. You don't need to use all lines. Choose as many as you like, from 1 - 2

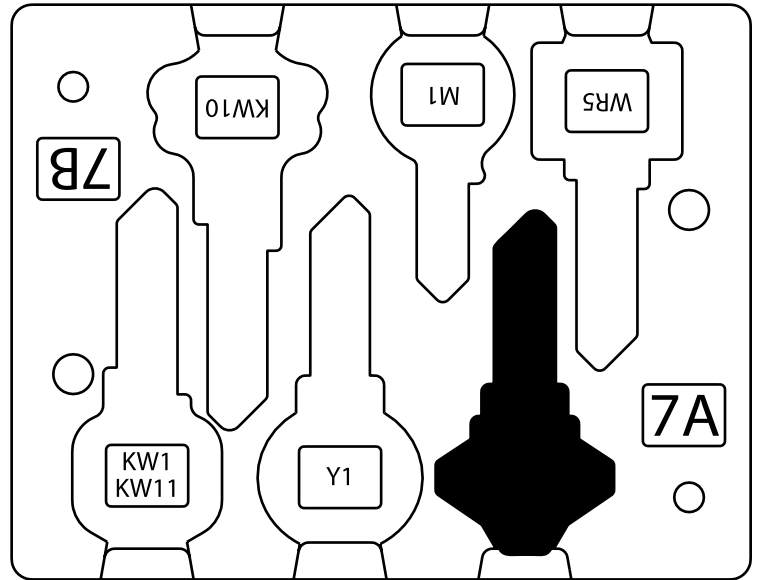

Fixture p/n 11240-06

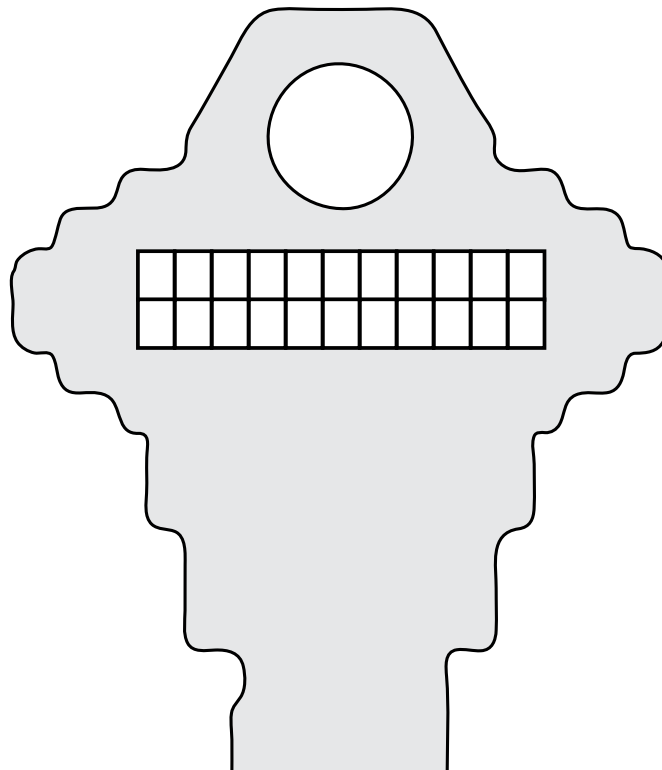

Owner: (Please Print Clearly)
Name: _____
Address: _____
City: _____ State _____ Zip _____
Phone # _____

Note: Use only Hillman brand keys.
Place key into carrier with the blank side up.

WR5 Key Template



Engraved text will be automatically centered and sized to the maximum space available. You don't need to use all lines. Choose as many as you like, from 1 - 2

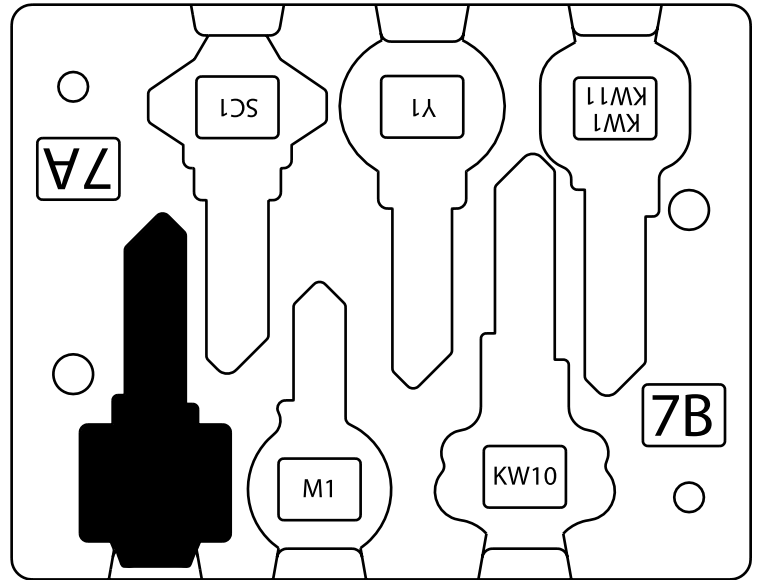
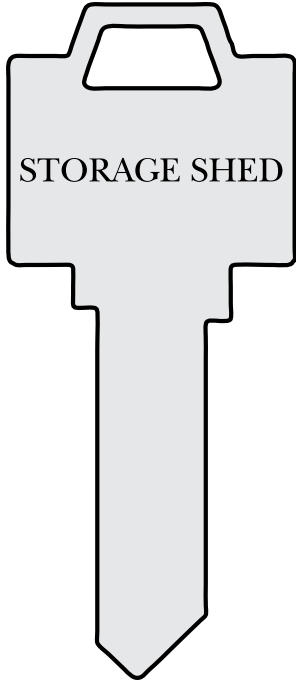

Fixture p/n 11240-06

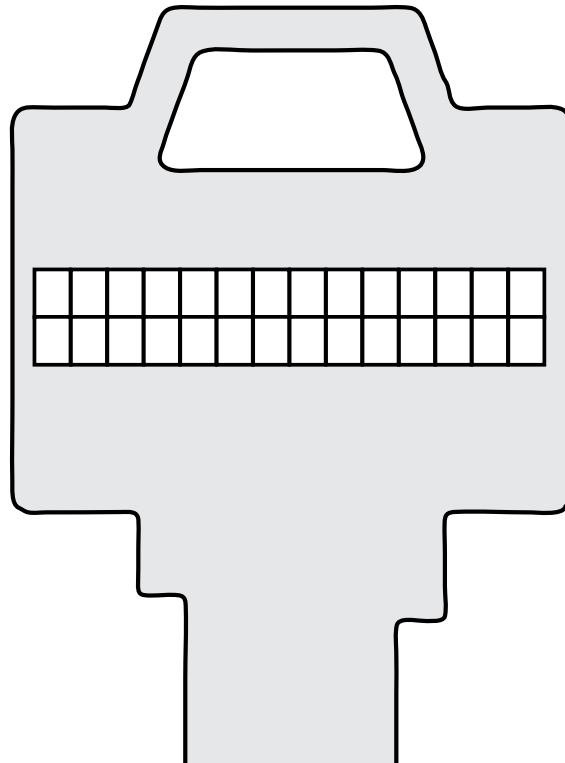

Owner: (Please Print Clearly)
Name: _____
Address: _____
City: _____ State _____ Zip _____
Phone # _____

Note: Use only Hillman brand keys.
Place key into carrier with the blank side up.

Y1 Key Template



Engraved text will be automatically centered and sized to the maximum space available. You don't need to use all lines. Choose as many as you like, from 1 - 2

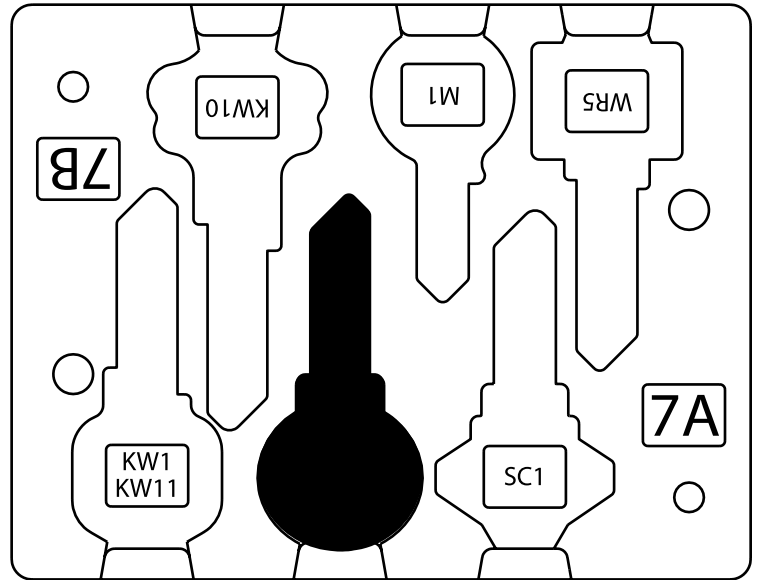
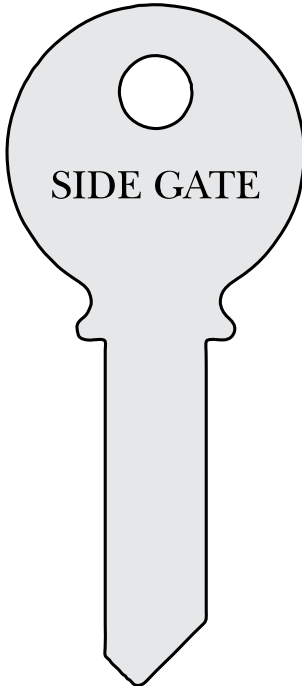

Fixture p/n 11240-06

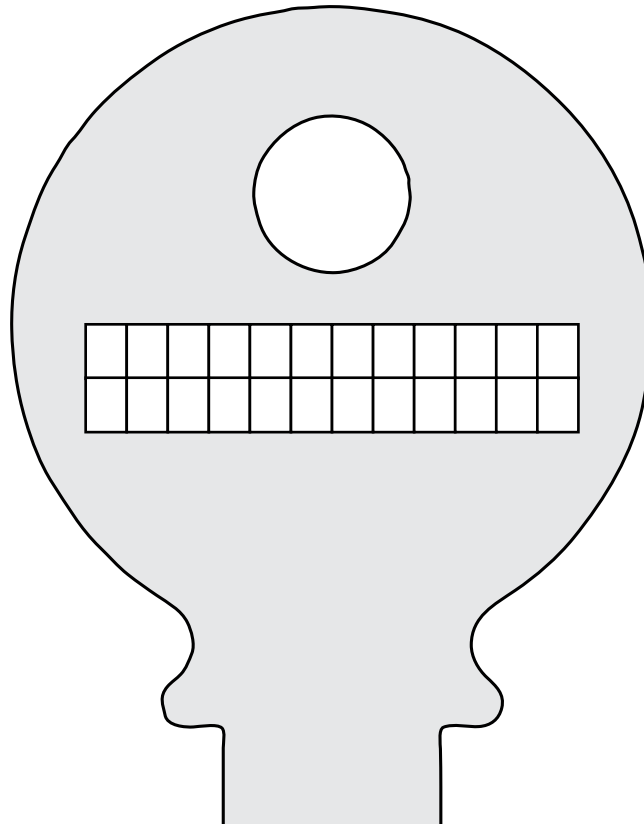

Owner: (Please Print Clearly)
Name: _____
Address: _____
City: _____ State _____ Zip _____
Phone # _____

Note: Use only Hillman brand keys.
Place key into carrier with the blank side up.

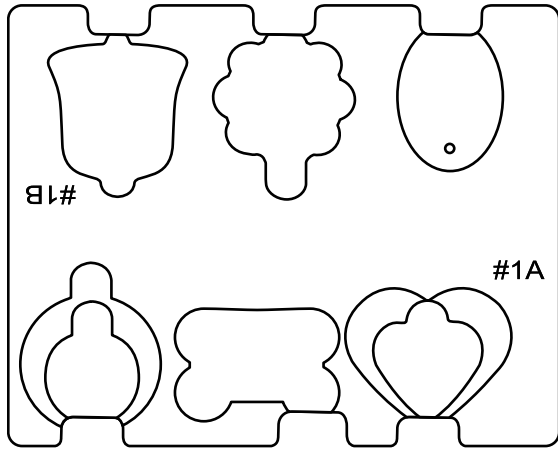

Fixture p/n 11238-01

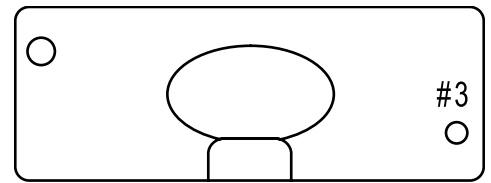

Fixture p/n 11240-02

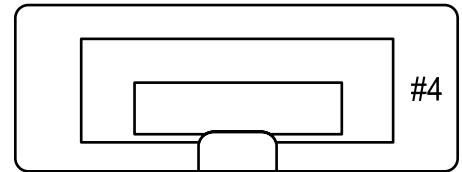

Fixture p/n 11240-03

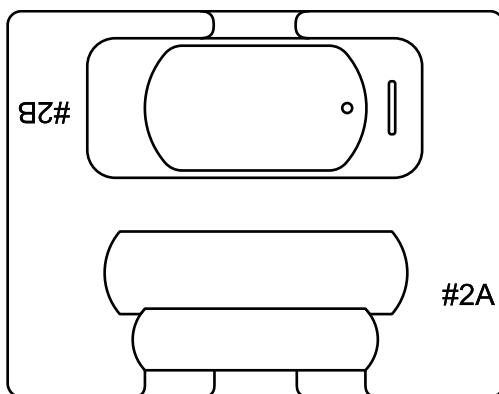

Fixture p/n 11238-02

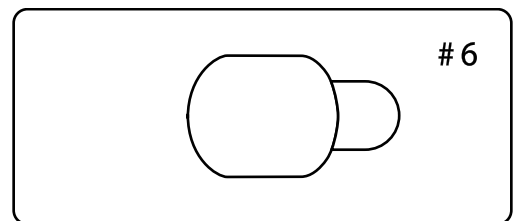

Fixture p/n 11240-04

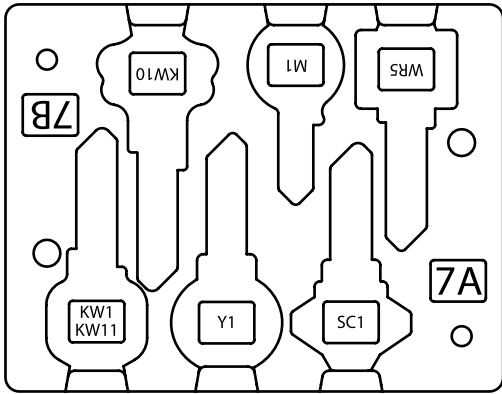

Fixture p/n 11240-06

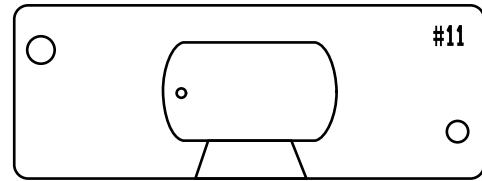

Fixture p/n 11240-08

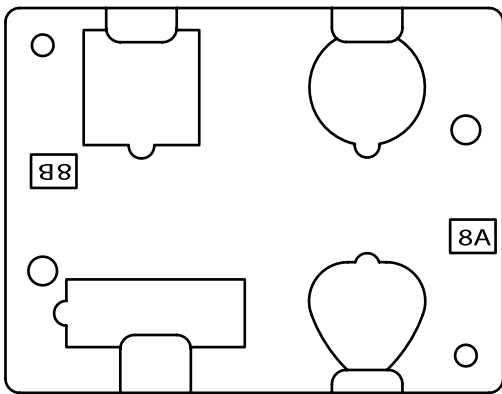

Fixture p/n 11238-07

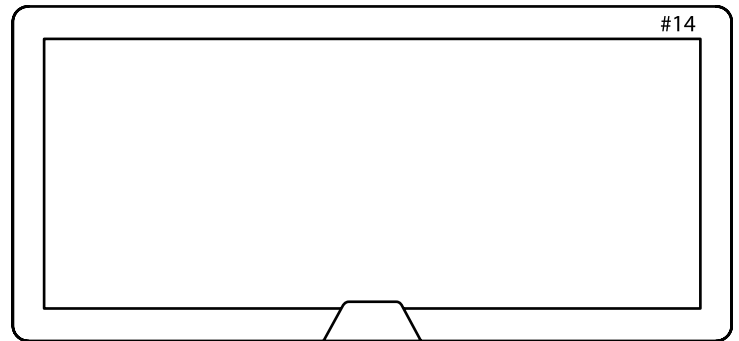

Fixture p/n 11240-14

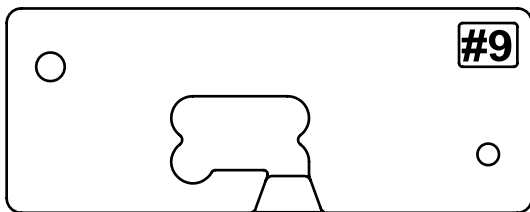

Fixture p/n 11240-07

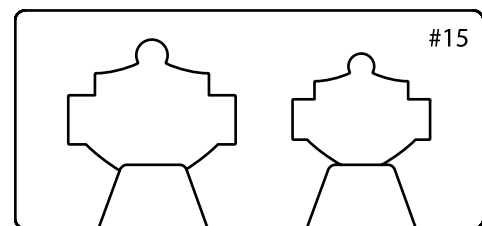

Fixture p/n 11240-11

NOTES: