



BALUSTRADE ALUMINIU
PROFILE
ACCESSORII

 **ALCONI**
profil concept





MODERN HARMONY OF SAFETY AND AESTHETICS

*Singura cale de trasa o granita sigura si estetica,
fara a pierde din libertate si spatiu...*



informatii firma

Firma noastra a inceput activitatea in anul 2010, din dorinta actionarilor de a oferi pietei, produse executate la un inalt standard al calitatii, ce ofera tuturor utilizatorilor, atat consumatorilor finali cat si distribuitorilor sau revanzatorilor, posibilitati neingradite in imbinarea sigurantei cu armonia, fara opturarea spatiului.

Schimbandu-si actionariatul in mai 2012, ALCONI Profil Concept, continua sa-si puna amprenta din ce in ce mai evident in piata furnizorilor si constructorilor de sisteme balustrade aluminiu eloxat, ajungand sa execute lucrari importante, atat pentru firme de renume din Bucuresti si din tara cat si pentru consumatori finali.

Odata cu schimbarea actionariatului, s-a schimbat si politica comerciala a firmei, dorinta noastra, incepand cu anul 2013, este sa acoperim toate zonele importante ale tarii prin parteneriate de lunga durata cu firme serioase, ce prin distributia produselor noastre, sa serveasca la cel mai inalt nivel al calitatii consumatorii finali carora se adreseaza.







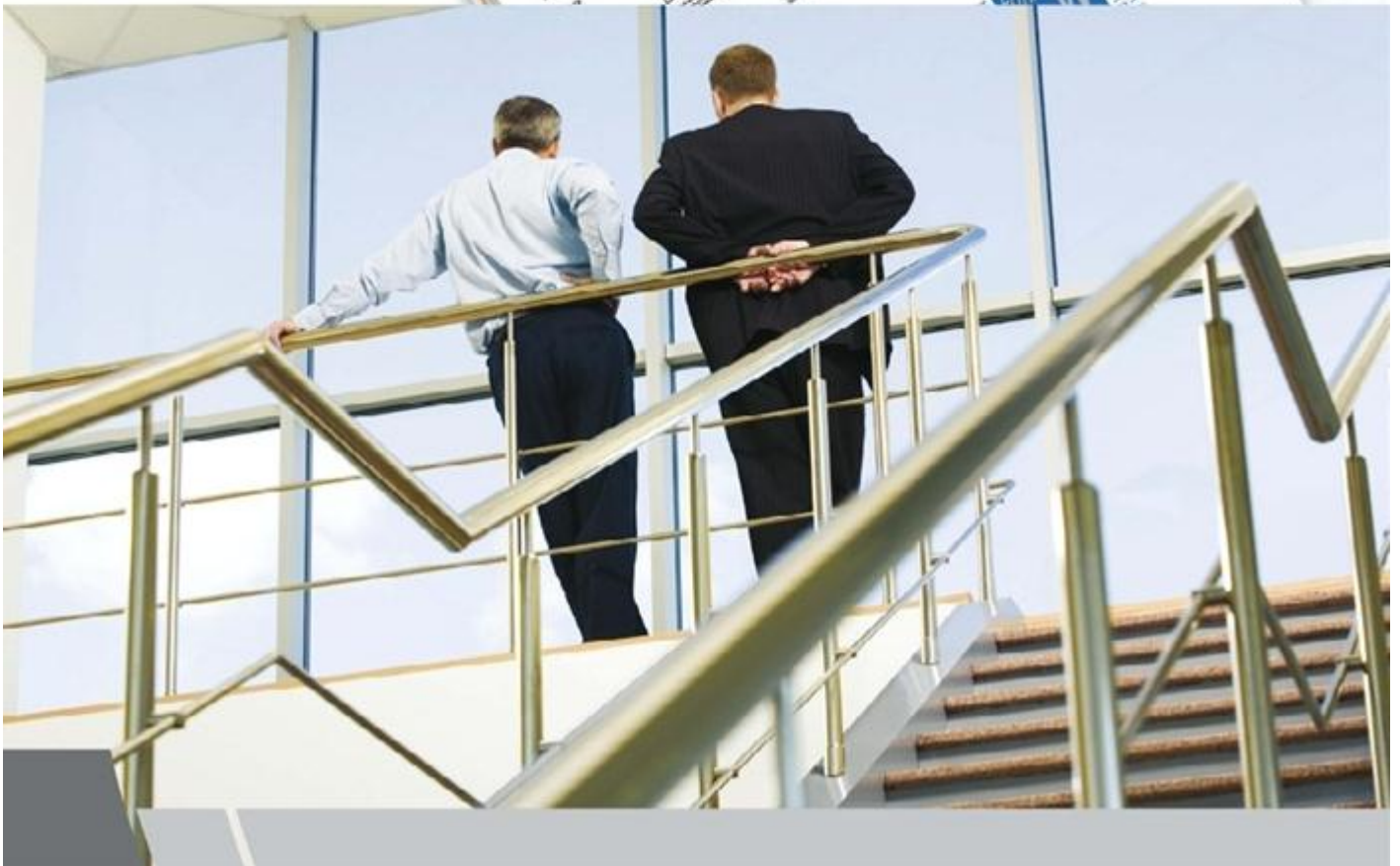



















Cu sistemul logistic reconstruit, cu o echipa formata din profesionisti cu experienta in domeniu, cu o politica de pret accesibila pentru toata gama de cumparatori si avand in spate un producator de renume mondial - prin intermediul caruia, poate oferi sisteme de balustrada aluminiu eloxat in toate variantele existente de elox (lucios sau mat), in toate variantele de culori (eloxat color) si in toate variantele de imitatie decor lemn (elox imitatie decor lemn) – ALCONI Profil Concept, este mai mult decat o firma, este un concept: BALUSTRADE!

filosofia calitatii























Filosofia Calitatii firmei noastre urmereste indeaproape linia trasata de producatorul nostru si are la baza tehnologia de ultima generatie, satisfactia clientilor, traning permanent, si o continua dezvoltare a produselor si serviciilor.













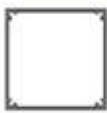

toate profilele

| Code/Kod | Drawing/Țiim | Theoretical Weight kg/m Teoric Ajerik kg/m | Code/Kod | Drawing/Țiim | Theoretical Weight kg/m Teoric Ajerik kg/m | Code/Kod | Drawing/Țiim | Theoretical Weight kg/m Teoric Ajerik kg/m |
|------------|--|---|-------------|---|---|------------|--|---|
| 10-128-025 |  Ø50x2.5 | 1.011 | 10-103-020 |  Ø16x2 | 0.238 | 18-103-015 |  Ø40x1.5 | 0.904 |
| 10-128-020 |  Ø50x2 | 0.817 | 10-103-050 |  Ø16x5 | 0.467 | 18-104-023 |  Ø40x2.3 | 0.945 |
| 10-128-015 |  Ø50x1.5 | 0.619 | 10-103-015 |  Ø16x1.5 | 0.185 | 18-105-020 |  Ø40x2 | 0.848 |
| 10-124-025 |  Ø40x2.5 | 0.798 | 12-141-020R |  Ø12x12x2 | 0.211 | 18-106-016 |  Ø40x1.6 | 0.718 |
| 10-122-025 |  Ø35x2.5 | 0.692 | 12-153-020R |  Ø14x14x2 | 0.258 | 18-107-020 |  Ø40x2 | 0.896 |
| 10-119-030 |  Ø30x3 | 0.689 | 12-133-013 |  Ø50x12x1.3 | 0.418 | 18-108-018 |  Ø40x1.8 | 0.853 |
| 10-119-025 |  Ø30x2.5 | 0.585 | 13-104-030 |  Ø20x3 | 0.163 | 18-113-023 |  Ø40x2.3 | 1.142 |
| 10-119-022 |  Ø30x2.2 | 0.521 | 18-101-023 |  Ø40x2.3 | 1.219 | 18-114-016 |  Ø40x1.6 | 1.065 |
| 10-103-040 |  Ø16x4 | 0.408 | 18-102-020 |  Ø40x2 | 1.050 | 18-126-015 |  Ø40x1.5 | 0.895 |

toate profilele

| Code/Kod | Drawing/Țiim | Theoretical Weight kg/m Teoric Ajerik kg/m | Code/Kod | Drawing/Țiim | Theoretical Weight kg/m Teoric Ajerik kg/m | Code/Kod | Drawing/Țiim | Theoretical Weight kg/m Teoric Ajerik kg/m |
|------------|--|---|------------|--|---|------------|--|---|
| 18-112-025 |  Ø50x2.5 | 1.652 | 18-204-00 |  | 0.059 | 18-118-020 |  50x2 | 1.204 |
| 18-109-018 |  Ø30x1.8 | 0.621 | 18-205-00 |  | 0.112 | 18-124-00 |  | 1.398 |
| 18-301-00 |  Ø60x3 | 1.380 | 18-209-00 |  | 0.081 | 18-311-00 |  | 3.894 |
| 18-110-015 |  Ø25x1.5 | 0.354 | 18-302-025 |  Ø50x2.5 | 1.282 | 18-312-00 |  | 6.689 |
| 18-111-015 |  Ø30x1.5 | 0.415 | 18-303-025 |  Ø60x2.5 | 1.494 | 18-313-017 |  Ø50x1.7 | 1.040 |
| 18-123-015 |  Ø30x1.5 | 0.457 | 18-306-00 |  | 5.262 | | | |
| 18-201-00 |  | 0.059 | 18-308-013 |  | 0.295 | | | |
| 18-202-00 |  | 0.067 | 18-309-013 |  | 0.198 | | | |
| 18 203 00 |  | 0.075 | 18-117-020 |  50x2 | 1.367 | | | |

toate profilele

| Code/Kod | Drawing/Çizim | Theoretical Weight kg/m Teorik Ağırlık kg/m | Code/Kod | Drawing/Çizim | Theoretical Weight kg/m Teorik Ağırlık kg/m |
|------------|--|--|------------|---|--|
| 18-119-020 |  80x30x2 | 1.355 | 18-125-016 |  75x75x1.5 | 1.423 |
| 18-120-020 |  80x30x2 | 1.606 | 18-207-00 |  | 0.064 |
| 18-127-018 |  60x25x1.8 | 1.108 | 18-208-00 |  | 0.171 |
| 18-128-018 |  60x25x1.8 | 0.921 | 18-206-00 |  | 0.058 |
| 18-121-00 |  50x25x2.5 | 1.026 | | | |
| 18-129-00 |  50x25x2.3 | 1.150 | | | |
| 18-122-00 |  30x25x1.8 | 0.508 | | | |
| 18-116-015 |  40x40x1.5 | 1.092 | | | |
| 18-115-015 |  40x40x1.5 | 0.990 | | | |

toate accesoriile



profile

Mana Curenta \varnothing 50

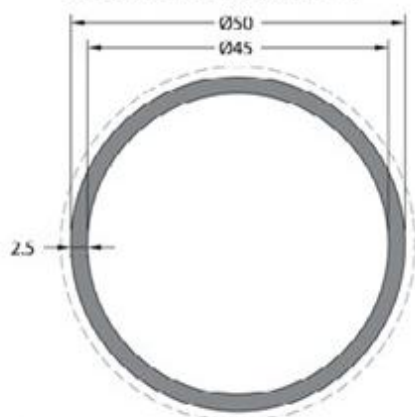

Greutate kg/m
1,1 kg

Mana Curenta \varnothing 40

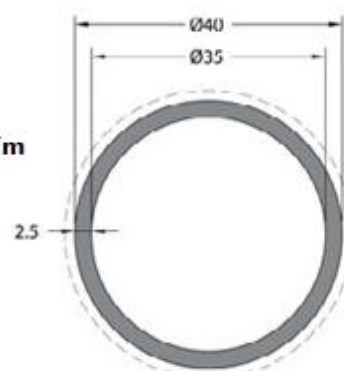

Greutate kg/m
0,800 kg

Montant \varnothing 40

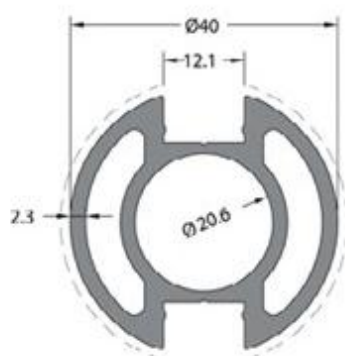

Greutate kg/m
1,25 kg

Montant \varnothing 40

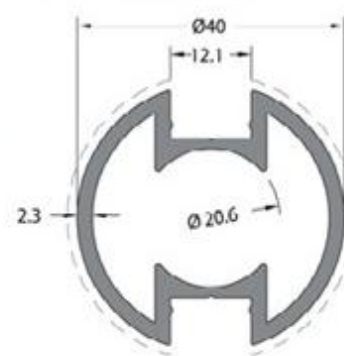

Greutate kg/m
0,980 kg

Bara ornament \varnothing 16

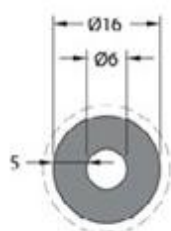

Greutate kg/m
0,480 kg

Bara ornament \varnothing 16

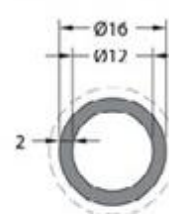

Greutate kg/m
0,280 kg

Clips montant

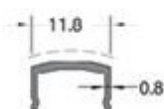

Greutate kg/m
0,06 kg

Mana curenta balustrada sticla

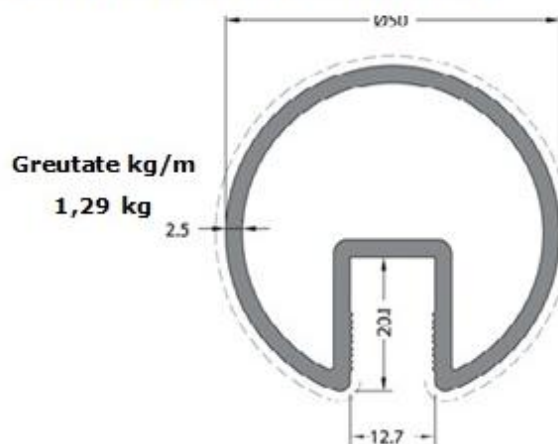

Greutate kg/m
1,29 kg

accesorii

ALC 12 - 401

Flansa montant $\varnothing 40$

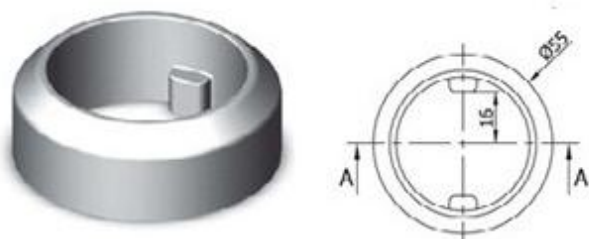

ALC 14 - 401

Inel mascare flansa exteriora montant $\varnothing 40$



ALC 14 - 501

Inel mascare flansa exteriora montant $\varnothing 50$

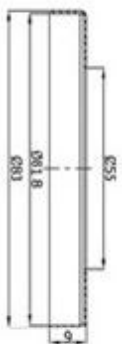

ALC 13 - 501

Flansa prindere mana curenta / perete

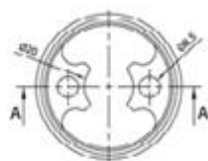

ALC 11 - 401

Flansa exteriora montant $\varnothing 40$

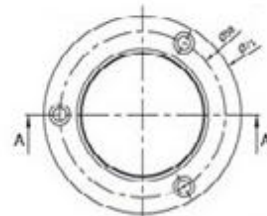

ALC 11 - 501

Flansa exteriora mana curenta $\varnothing 50$

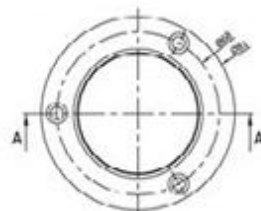

ALC 11 - 161

Flansa exteriora $\varnothing 16$

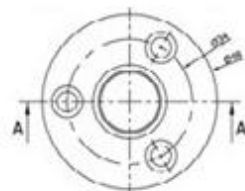

ALC 32 - 402

Inel prindere laterala $\varnothing 40$

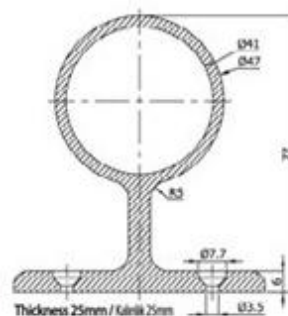

ALC 74 - 502

Cot 90° pt ø 50

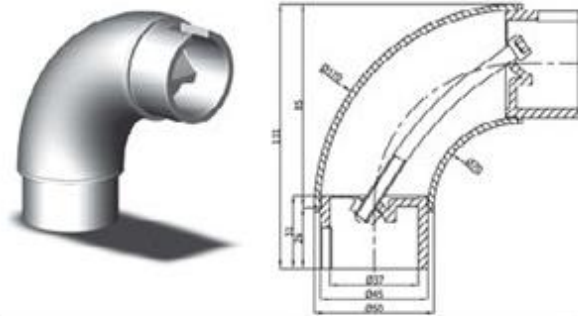

ALC 74 - 501

Cot 45° pt ø 50

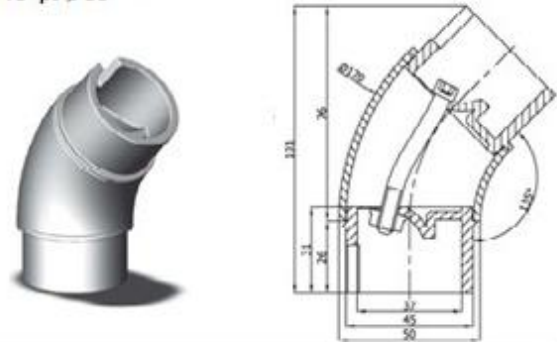

ALC 72 - 501

Cot variabil pt ø 50

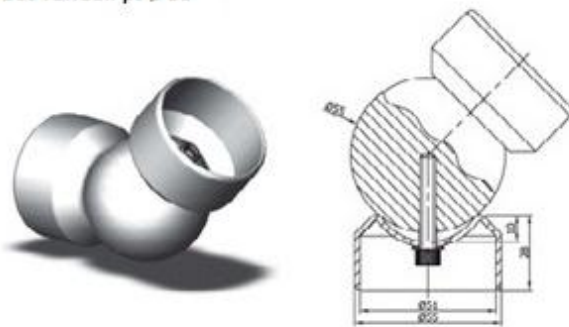

ALC 72 - 502

Cot variabil montant ø 40 / mană curentă ø 50

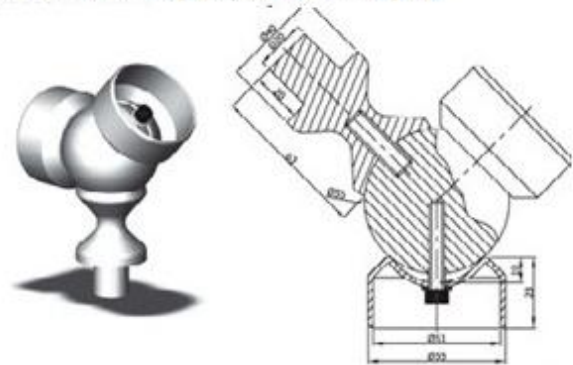

ALC 71 - 501

Cot simplu 90° pt ø 50

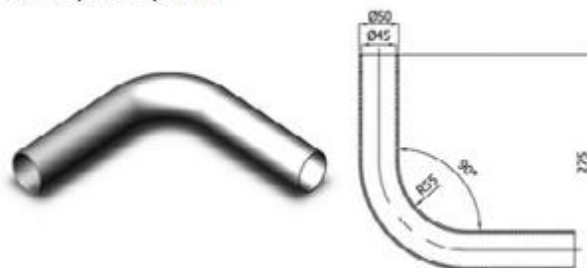

ALC 71 - 161

Cot 90° pt ø 16

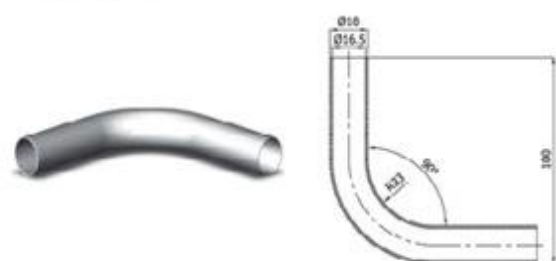

ALC 71 - 162

Cot 135° pt ø 16

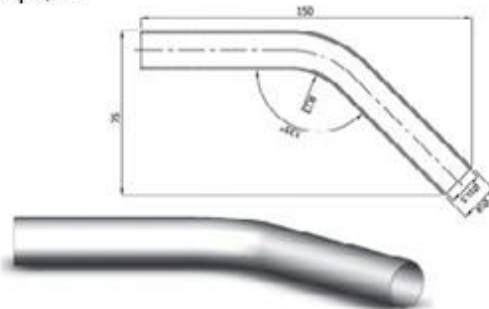

ALC 71 - 163

Cot 30° pt ø 16

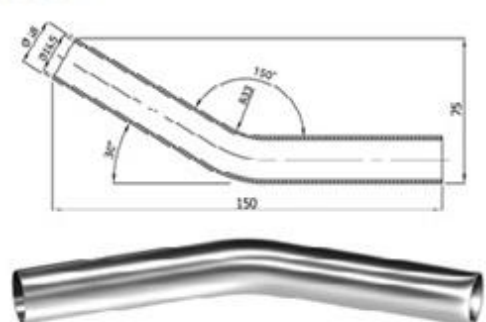

accesorii

ALC 31 - 161

Inel prelungitor $\varnothing 16$

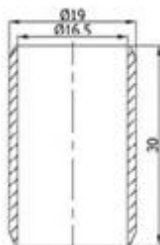

ALC 31 - 501

Inel mascare / imbinare $\varnothing 50$

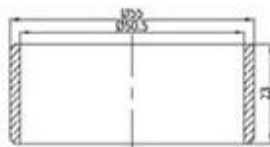

ALC 32 - 401

Piesa prindere laterala montant $\varnothing 40$

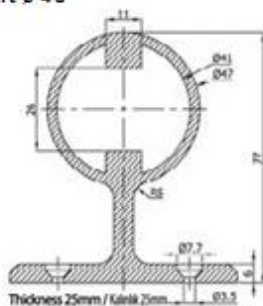

ALC 68 - 402

Piesa prindere laterala „tip pahar” $\varnothing 40$

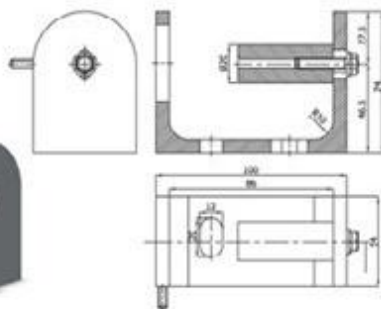

ALC 31 - 502

Inel lung mascare / imbinare $\varnothing 50$

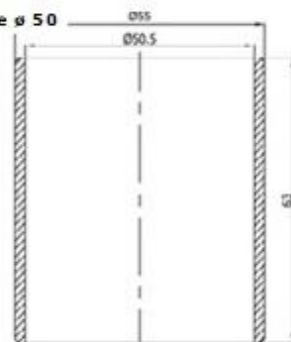

ALC 31 - 401

Inel mascare / imbinare $\varnothing 40$



ALC 32 - 402

Piesa prindere laterala $\varnothing 40$

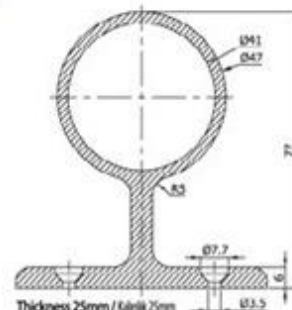

ALC 41 - 402

Dop mascare $\varnothing 40$

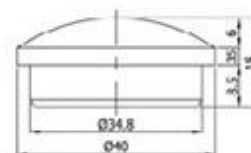

accesorii

ALC 41 - 501

Dop mascare $\varnothing 50$



ALC 41 - 401

Dop mascare inferior montant $\varnothing 40$



ALC 41 - 161

Dop mascare $\varnothing 16 \times 5$ mm

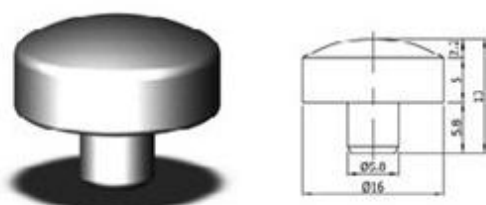

ALC 41 - 162

Dop mascare $\varnothing 16 \times 2$ mm

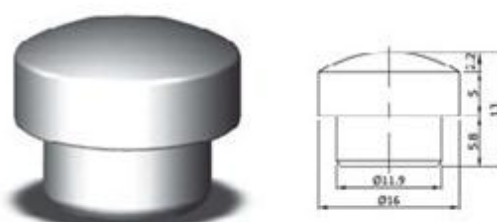

ALC 61 - 162

Suport trãversã $\varnothing 16$ cu bumb

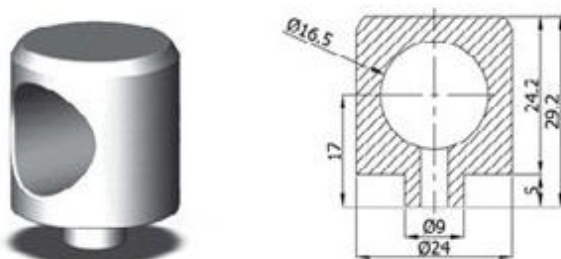

ALC 61 - 161

Suport trãversã $\varnothing 16$ pe rotund

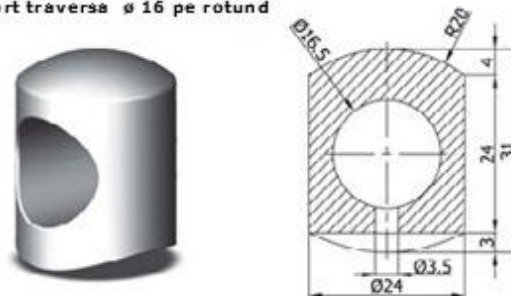

ALC 51 - 402

Piesã sticlã pt canal montãnt $\varnothing 40$

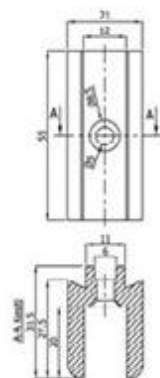
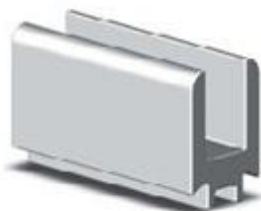

ALC 51 - 401

Piesã sticlã pe rotund montãnt $\varnothing 40$



ALC 51 – 407

Piesa sticla reglabila cu garnitura pe rotund

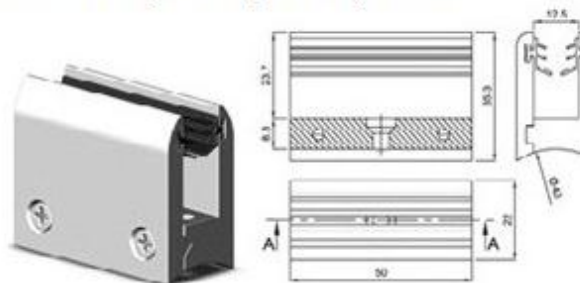

ALC 51 – 408

Piesa sticla reglabila cu garnitura pt canal montant



ALC 54 – 401

Stoper sticla

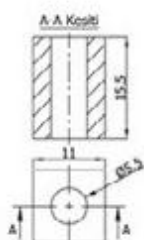

ALC 53 – 402

Spider dublu

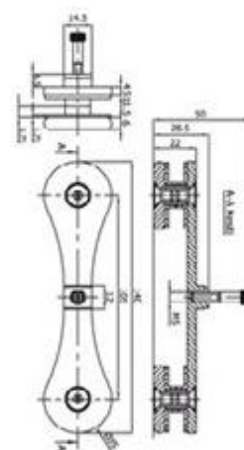

07

Bulon prindere pardoseala montant $\varnothing 40$

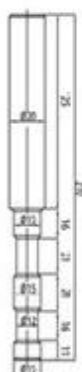

ALC FIX

Adeziv fixare bulon in pardoseala



model balustrade

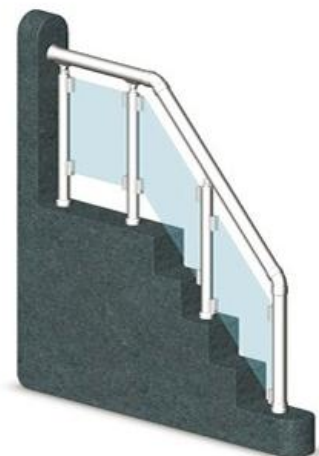
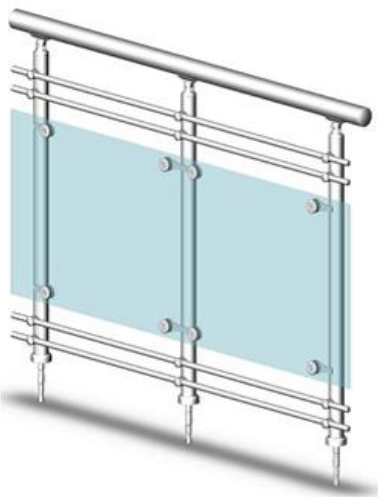
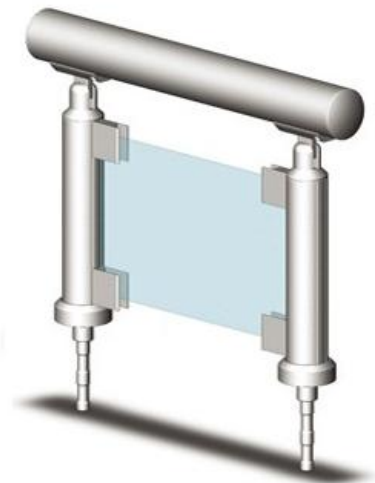
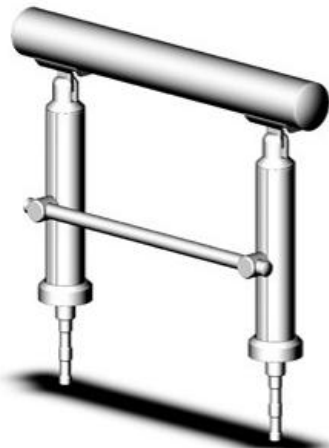

model balustrade

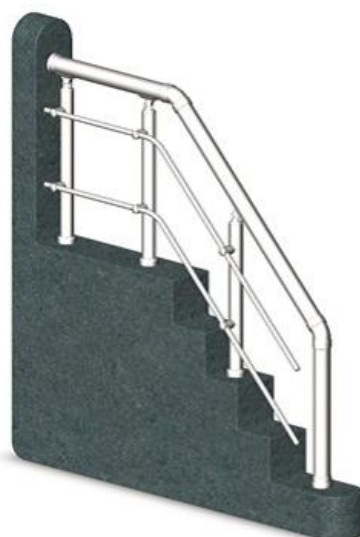
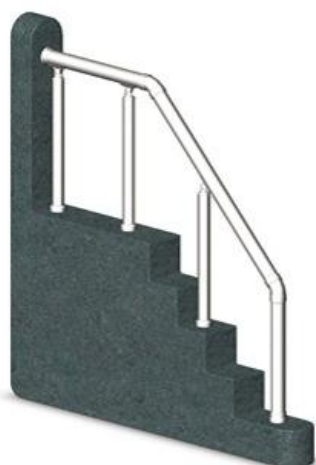



ALCONI Profil Concept S.R.L

Sediul: Str Burdujeni, nr 7, Sector 3, Bucuresti

Punct de lucru: Str Mircea cel Batran, Sector 5

Web: www.alconi.ro / www.alu-profile.ro

Mail: office@alconi.ro; alu.profile@yahoo.com

Facebook: Balustrade Aluminiu; Profile Aluminiu

Tel. / Fax: 021 776 91 08

Mobil: 0751 51 56 22 / 0751 51 56 23

