



# Owner Instructions

Original instructions

Warning! Read instructions before using the machine



CRO 8055/100T  
CRO 8055/120T  
Ride On Scrubber Dryer



[www.numatic.com](http://www.numatic.com)





<b>Index</b>	Page 2
<b>Machine overview</b>	Page 3
<b>Control panel overview</b>	Page 4
<b>Rating label / Personal Protective Equipment / Recycling</b>	Page 5
<b>Safety Precautions</b>	Page 6
<b>Quick set-up guide</b>	<b>Page 7</b>
<b>Machine set-up</b>	
Raise / Lower the Floor-tool	Page 8
Fitting the Floor-tool	Page 8
Breakaway Floor-tool feature	Page 8
Raise / Lower the Brush Deck	Page 9
Fitting the Brush	Page 9
Floor-tool transit bracket	Page 9
Filling the clean-water tank	Page 10
Fill Level Indicator	Page 10
<b>Machine Operation</b>	
Pre-cleaning advice	Page 11
Setting the cleaning controls	Page 11
Waste water tank full	Page 11
Brush pressure	Page 12
Emergency stop button and horn	Page 12
Anti-tip System	Page 12
Machine usage advice	Page 13
Maximum Speed Control	Page 13
Hose U-Bend Clip	Page 14
Off-aisle cleaning kit (optional)	Page 14
<b>Machine Cleaning</b>	
Tanks and Filters	Page 15 to 16
Floor-tool cleaning and blade replacement	Page 17
Floor-tool height adjustment	Page 18
<b>Machine Charging</b>	Page 19
<b>Free-wheel function</b>	Page 20
<b>Battery care / Trouble-shooting / Specifications</b>	Page 21 to 24
<b>Recommended spare parts</b>	Page 25
<b>Schematic / Declaration Document</b>	Page 26
Warranty	Page 27
Company address	Page 28

## Machine Overview

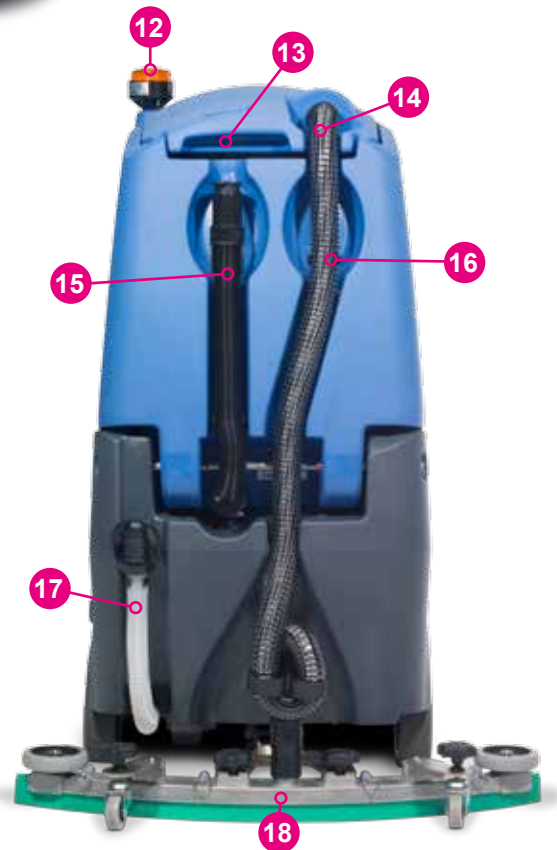

1	Operator control panel	10	On-board charger and charge indicator
2	Brush deck foot pedal	11	Accelerator pedal
3	Anti-tip buffers	12	Pedestrian warning light
4	Floor-tool raise / lower lever	13	Floor-tool transit bracket
5	Clean water tank fill point	14	Air separator assembly
6	Brush deck	15	Waste water emptying hose
7	40 Amp battery fuse	16	Vacuum hose
8	Gel batteries	17	Clean water tank emptying hose
9	Clean water tank filter	18	Floor-tool

## Control Panel Overview



1	Water Flow Rate Indicator and Selection Button
2	Brush Engage and Disengage Button
3	Service Indicator
4	Brush Pressure / Load Indicator
5	Run Time Selection Button
6	Battery Charge Level Indicator
7	Off Aisle Vacuum Button
8	On / Off Switch
9	Forward / Reverse Switch
10	LED Status Indicator
11	Maximum Speed Control
12	Horn Button
13	Emergency Stop Button

# About the Machine

Rating Label	
1	Company Name & Address
2	Machine Description
3	Power rating
4	Voltage Frequency
5	Max Gradient
6	CE Mark
7	Weight (ready to use)
8	WEEE Logo
9	Ingress Protection Rating
10	Machine yr/wk Serial number

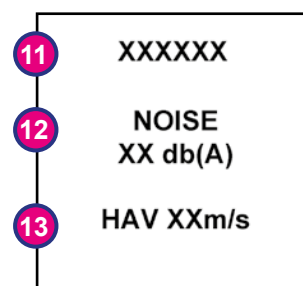
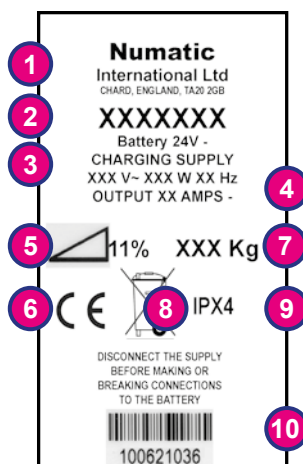

11	Machine Description
12	Noise Rating
13	Hand Arm Vibration

## WEEE (Waste, Electrical and Electronic Equipment)

Scrubber dryer Accessories and packaging should be sorted for environmentally-friendly recycling.

**Only for EU countries.**

Do not dispose of scrubber-dryer into household waste.

According to the European Directive 2002/96/EC on waste electrical electronic equipment and its incorporation into national law.

Scrubber-dryers that are no longer suitable for use must be separated, collected and sent for recovery in an environmentally-friendly manner.

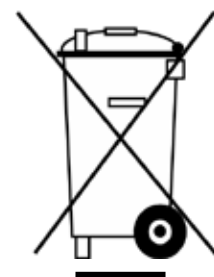

## PPE (Personal protective equipment) that may be required for certain operations.

Ear Protection	Safety Footwear	Head Protection	Safety Gloves	
Dust/Allergens Protection	Eye Protection	Protective Clothing	Hi-Vis Jacket	
				Caution Wet Floor Sign

### Note:

A risk assessment should be conducted to determine which PPE should be worn.

### Safety Critical Component:

Charging Leads: Ho5VV-F x 1.0 mm<sup>2</sup> x 3 Core  
 Transaxle 205190  
 Battery Charger (230V)  
 (115V)

## Caution



**No HOT drinks  
 when operating this  
 machine.**

**In the event of a breakdown contact your Numatic dealer or the  
 Numatic Technical help line +44 (0)1460 269268**



## ORIGINAL INSTRUCTIONS READ MANUAL BEFORE USE

# Information for Scrubber Dryer



### WARNING

As with all electrical equipment care and attention must be exercised at all times during its use, in addition to ensuring that routine and preventative maintenance is carried out periodically in order to ensure its safe operation.

Failure to carry out maintenance as necessary, including the replacement of parts to the correct standard could render this equipment unsafe and the manufacturer can accept no responsibility or liability in this respect. When ordering spare parts always quote the Model Number / Serial Number specified on the Rating Plate.

This appliance is not intended for use by persons (including children) with reduced physical, sensory or mental capabilities, or lack of experience and knowledge, unless they have been given supervision or instruction concerning use of the appliance by a person responsible for their safety. Children should be supervised to ensure that they do not play with the appliance.

If this product does not have a factory installed Numatic battery charger and batteries then it is the responsibility of the owner and user of the product to ensure that the charging system and battery combination are compatible, fit for purpose and safe to use.

Only use brushes provided with the appliance or those specified in the instruction manual.

The use of other brushes may impair safety.

A full range of brushes and accessories are available for this product. Only use brushes or pads which are suitable for the correct operation of the machine for the specific task being performed.

It is essential that this equipment is correctly assembled and operated in accordance with current safety regulations.

When using the equipment always ensure that all necessary precautions are taken to guarantee the safety of the operator and any other persons who may be affected.

Wear nonslip footwear when scrubbing. Use a respiratory mask in dusty environments.

The machine, while charging, must be positioned so that the mains plug is easily accessible.

Remove the key from the ignition when cleaning and carrying out routine maintenance. When replacing major components the ignition key and battery fuses MUST be removed.

If this product does not have a factory installed Numatic battery charger and batteries then it is the responsibility of the owner and user of the product to ensure that the charging system and battery combination are compatible, fit for purpose and safe to use.

Machines left unattended shall be secured against unintentional movement.

When detergents or other liquids are used, read the manufacturer's instructions.

Operators shall be adequately instructed as to the correct use of the machine.



### CAUTION

This machine is not suitable for picking-up hazardous dust.

Do not use on surfaces having a gradient exceeding that marked on the appliance.

The machine is not to be stored outdoors in wet conditions.

This machine is for indoor use only.

Read the instruction manual before using the appliance.

This product meets the requirements of IEC 60335-2-72

### NOTES

This machine is also suitable for commercial use, for example in hotels, schools, hospitals, factories, shops and offices for other than normal housekeeping purposes.



### DO

- Ensure only competent persons unpack/assemble the machine.
- Keep your machine clean.
- Keep your brushes in good condition.
- Replace any worn or damaged parts immediately.
- Regularly examine the power cord for damage, such as cracking or ageing. If damage is found, replace the cord before further use.
- Only replace the power cord with the correct Numatic approved replacement parts.
- Ensure that the work area is clear of obstructions and / or people.
- Ensure that the working area is well illuminated.
- Pre-sweep the area to be cleaned.



### DON'T

- Use steam cleaners or pressure washers to clean the machine or use in the rain.
- Attempt machine maintenance or cleaning unless the power plug has been removed from the supply outlet, if the machine is in charge mode or remove the key if in normal use.
- Allow any inexperienced repairs. Contact your nearest service centre.
- Strain charger lead or try to unplug by pulling on charger lead.
- Leave the brush deck in the lowered position when not in use.
- Expect the machine to provide trouble-free, reliable operation unless maintained correctly.
- Run the machine over any power cables during operation.

## Precautions when working with batteries

1. Always wear protective clothing e.g. face visor, gloves and overalls when working with batteries.
2. Whenever possible always use a properly designated and well-ventilated area for charging. Do not smoke or bring naked flames into the charging area.
3. Remove any metallic items from hands, wrists and neck i.e. rings, chains etc. before working on a battery.
4. Never rest tools or metallic objects on top of the battery.
5. When charging is complete disconnect from the mains supply.
6. The machine must be disconnected from the supply when removing the battery.
7. To remove the batteries:- Disconnect machine from the mains supply (if charging), raise waste water tank and ensure batteries are isolated by removing fuses. Disconnect hoses from separator and tanks, Undo battery terminals and remove batteries.
8. Only use genuine Numatic replacement batteries.
9. Do not allow the batteries to become fully discharged, it may not be possible to recharge them.
10. Do not allow one battery to be discharged separately to the other.
11. Do not mix batteries from different machines.
12. The batteries fitted to this product are Valve Regulated Lead Acid (VRLA) gel electrolyte type. The fitting of any other type of battery may cause a safety hazard.
13. The batteries must be removed from the machine before it is scrapped.
14. Dispose of the batteries safely in accordance with local government regulations.

### BATTERY CARE

1. Always recharge the batteries after use. This can be done at any time – it is not necessary to wait until they are fully discharged; they do not develop a “memory”.
2. Leaving the charger to operate for a minimum of 4 hours after the green light has come on, at least weekly, will pro-long battery life.
3. Do not store the machine with the batteries discharged.

## Quick Set-Up Guide



**PLEASE READ BEFORE COMMENCING ANY OPERATION  
AFTER THE REMOVAL OF ALL THE PACKAGING, CAREFULLY OPEN AND CHECK THE CONTENTS.**



### Contents:

- 1 x Operator Manual
- 2 x Battery Charger Lead
- 2 x Keys
- 1 x 40 Amp Fuse (1 x Spare)
- 1 x Maxi Fuse-puller



Lift top tank assembly to reveal battery compartment.  
Always lift between points as illustrated to ensure personal safety (Fig.1).  
Fit battery fuse into the battery fuse holder as illustrated (Fig.2).  
Remove transit block from pallet (Fig.3).



**Ensure no metal objects come into contact with battery terminals while the batteries are exposed. When inserting the fuse you may notice a spark, this is normal.**



Insert key into ignition and turn quarter-turn clockwise to the 'ON' (1) position, make sure that the forward / reverse switch is set to forward and the speed control is set to low (Fig.4).  
DO NOT depress accelerator pedal while software initialises.  
Depress accelerator pedal with right foot and slowly drive machine off of the pallet using the ramp provided (Fig.5).  
Make sure the ramp is central to the machine and drive off straight.  
**Note: The seat is fitted with a pressure sensor that disables the machine until an operator is seated.**  
When the machine is removed and in a safe position, turn key back to the 'OFF' (0) position (Fig.6).

## Machine Set-Up



*Always ensure that the machine is switched off before making any adjustments*



### Raise / Lower the Floor-tool



To lower the floor-tool move the floor-tool lever into the upper position (Fig.7/9).  
To raise the floor-tool move the floor-tool lever into the lower position (Fig.8).

**Note:** *The machine will not operate in reverse with the Floor-tool lowered.*

**Note:** *The floor-tool lever guide is designed to be reversible and replaceable.*

### Fitting the Floor-tool



Lower the floor-tool arm by moving the floor-tool lever to the upper position (See above).  
Loosen the retaining knobs on the floor-tool and slide onto the holding bracket (Fig.10).  
Tighten the retaining knobs to finger tight. (Fig.11).  
Push waste collection pipe onto the floor-tool; ensure a tight fit (Fig.12).

**Note:** *Raise floor-tool again before driving to the cleaning area (See Above).*

### Break-away Floor-tool

The floor-tool design incorporates a safety knock-off feature.

Allowing it to safely disengage from its mounting should it become caught on an obstruction during forward movement (Fig.13).

Make sure you do not over tighten the retaining knobs to ensure correct operation.



## Machine Set-Up



Always ensure that the machine is switched off before making any adjustments



### Raise / Lower the Brush Deck



To lower the brush deck slide the brush deck foot pedal forward with your foot (Fig.14) and gently release the foot pedal (Fig.15). The brush deck is now in the lowered position.

To raise the brush deck slowly depress the foot pedal, ensuring it is in the forward position (Fig.16) and slide your foot back to lock the pedal in place (Fig.17).

The brush deck is now in the raised position.

### Fitting the Brush

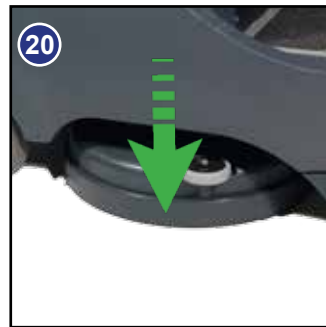

Make sure the brush deck is in the raised position (see above) and place the brush under the brush deck (Fig.18) ensuring it is central to the chuck (Fig.19), then lower the brush deck (see above).

Turn on the machine by inserting the key and turning a quarter-turn clockwise.

Press the brush engage button and the machine will pick up the brush (Fig.21).

Turn off the machine by turning the key a quarter-turn anti clockwise.

To disengage the brush press the brush engage button with the brush deck in the raised position.

**Note: Do not lift the brush deck until the brush has stopped revolving or the brush will release. Make sure you raise the brush deck before driving to the cleaning site.**



Safety Gloves are recommended for the changing of used Brushes.



### Floor-tool Transit Bracket



When in transit, the Floor-tool can be placed on the bracket at the rear of the machine.

Simply slot the retaining knob into the bracket.

## Machine Set-Up



*Always ensure that the machine is switched off before making any adjustments*



### Filling the Clean-water Tank

The CRO 8055 is equipped with a large capacity 80 litre clean water tank, allowing for large areas to be covered in a single fill.



To fill the clean water tank extend the Flexifill hose, remove the rubber seal and fill from a suitable water outlet (Fig.22). Replace seal and hose to original position when finished.

Alternatively unscrew the filler cap completely (Fig.23) and fill the tank using a hose or preferred method (Fig.24).

**Note:** Great care must be taken to ensure that contaminants (leaves, hair, dirt, etc.) are not allowed to enter the clean-water tank during the filling process. If using a bucket or similar, ensure it is always clean and free from debris.

### Fill Level Indicator



When filling the clean water tank, do not fill above the clean water tank emptying hose retaining clip (Fig.25). This can be found at the rear of the machine.



*If you need to access the batteries, make sure that the waste-water tank is empty before lifting.*



# Machine Operation



## IMPORTANT

**Do not operate machine unless the operator manual has been read and fully understood.**



The machine is now ready to be driven to the cleaning site (see the quick set-up guide if necessary). Before performing the cleaning operation, place out appropriate warning signs and sweep or dust-mop the floor.

**When you have arrived at the cleaning site, lower the Floor-tool (see page 8) and the brush deck (see page 9).**

## Setting the Cleaning Controls

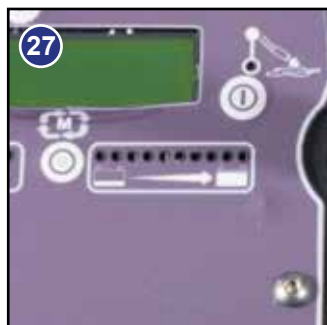

Insert the key into the on / off switch and quarter-turn it clockwise to the 'ON' (1) position (Fig.26).

The battery charge-level indicator will illuminate (Fig.27).

Set the water flow rate as required, depending on floor type and level of soiling.

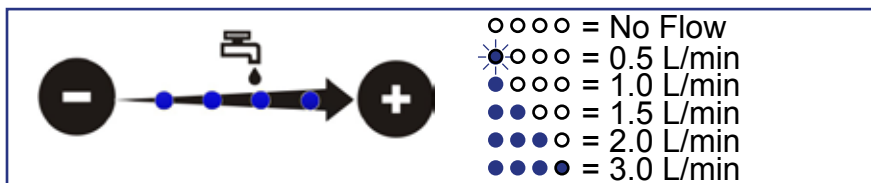

## Waste-water Tank Full



The vac shut off system fitted to your machine stops the airflow when the top tank is full!

It does not shut the power off to the vac motor, the vac motor will continue to run, but there is an audible difference in the sound when the shut off system operates.

See Page 16 for more details on checking and cleaning the shut off system.

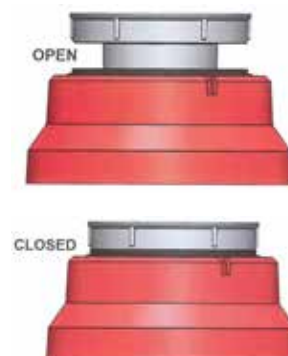

**Always ensure that the floor is pre-swept and relevant safety signs are displayed.**



# Machine Operation

## Brush Pressure



The machine is equipped with a brush-pressure load warning system (Fig.28). As the load on the Brush increases the LEDs on the Load Indicator will illuminate from left to right.



**Note:** The run-time of the machine may decrease if the load on the brushes is increased

## Emergency Stop Button and Horn

The CRO 8055 is equipped with an electronic braking system. Simply lift your foot from the accelerator and the machine will stop. In an emergency, strike the emergency-stop button and the machine will be disabled. To reset, turn emergency stop button clockwise (Fig.29). After resetting the emergency stop button, to restart the machine, turn the ignition key to the 'Off' then the 'On' position again.



The horn is located on the right-hand side of the operator control panel (Fig.30).

## Anti-tip System



**Care must be taken to reduce speed when cornering or manoeuvring**



The CRO 8055 is equipped with an Anti-tip system. If the operator attempts to turn a corner when the machine is going at speed, the machine will automatically slow down preventing the machine from tipping over. Additionally the buffers at the front of the machine are designed to prevent the machine tipping in the event of the operator turning sharply (Fig.31).

The buffers are designed to be replaceable when worn.

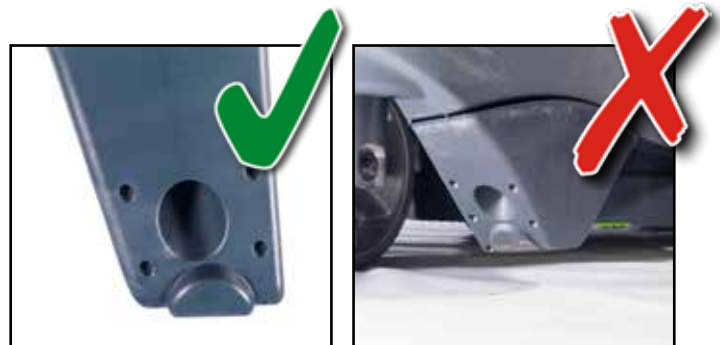

# Machine Operation

## Machine in Use



To operate, select forward, press the accelerator pedal.

Vacuum pick-up and water-flow will turn on if selected and the brush and floor tool are in the lowered position, the machine will move forward.

Clean water is dispersed evenly via 'THRU- FEED' scrubbing brushes.

The waste water is then retrieved by the suction floor-tool (Fig.32).  
Overlap each scrubbing path by 10cm to ensure an even clean.

After stopping the Vac motor will run for a further 10 seconds to collect any water left in the vacuum hose.



**Do not operate the machine on inclines that exceed 11%.**



If streaking occurs wipe floor-tool blades clean (Fig.33).  
On heavily soiled floors use a 'double scrub' technique.  
First pre-scrub the floor with the floor-tool in the raised position, allow the chemicals time to work then scrub the area a second time with the floor-tool lowered (Fig.34).



## Maximum Speed Control



Use the maximum speed control knob and set desired traction speed as required, depending on floor type and level of soiling (Fig.35).

Keep speed setting within the white gradient on the dial for optimum floor cleaning.

The grey gradient on the dial is for setting the transit speed.

Cleaning



Transit

Once the Max speed has been set using the control knob on the control panel, fine adjustments can be made using the variable control speed pedal located on the right side of the footplate.

## Machine Operation

### Hose U-bend Clip

The vacuum hose has a U-bend clip which creates a U-bend in the hose preventing water spillage when the vacuum is switched off. If you need to remove the U-bend clip for any reason always ensure it is refitted correctly before you resume operation (Fig 36-39).

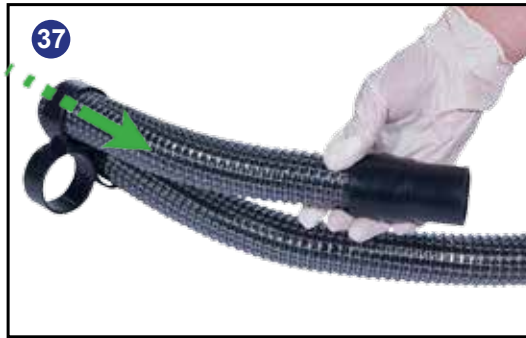

Refit vacuum hose to the Floor-tool when finished.

**Note: DO NOT push the vacuum hose onto the Floor-tool with the Floor-tool in the raised position.**

## Off-Aisle Cleaning Kit (Optional Extra Accessory ) 606182



The optional off-aisle cleaning kit gives added flexibility to the operator. The kit can be used to clean hard to reach / inaccessible areas (Fig 40).

Remove the Vacuum hose from the Floor-tool and attach to the Off-aisle kit.

To operate the vacuum, press the Off-aisle vacuum button on the control panel.

Pressing the Off-aisle Button again will switch the vacuum off (Fig 41).

**Note: Return the hose to the floor-tool once finished using the off-aisle facility.**



# Machine Cleaning



Always ensure that the machine is switched off prior to any maintenance.

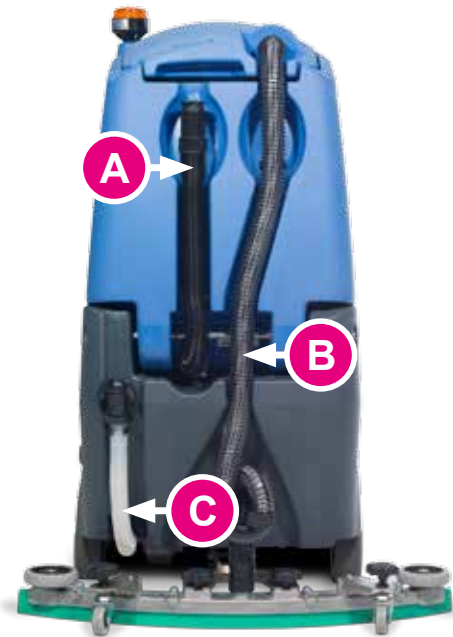

After use, empty waste-water tank using emptying hose and flush-out with clean water. **A**

Next remove floor-tool vacuum hose ensuring you remove the U-bend clip and flush out with clean water. **B**

Next empty clean water tank, using emptying hose and again flush out with clean water. **C**



Before removing the separator, first pull off the connected hose (Fig.42). Remove the separator and rinse using clean water (Fig.43). The separator also has a sealing-rubber which should be examined at every clean-down (Fig.44).

**Note:** The separator can be hung from either side of the top tank while you maintain the machine using the clip on the front of the lid. (Fig.45).



When refitting the separator make sure you engage the tab (A) at the front of the separator BEFORE pushing the separator down.

Refit the vacuum hose.

## Machine Cleaning



*Always ensure that the machine is switched off prior to any maintenance.*



Located in your waste water (top) tank is a vacuum shut off system, this prevents suction when the waste water tank is full. It also prevents foam created by high-foaming detergents from entering the motor. Sometimes the float vents get clogged and blocked, clean to ensure correct operation (Fig.46-47) regularly check and clean the air filter in the top of the assembly.

Remove debris basket filter and rinse using clean water, and refit (Fig 48).

**IMPORTANT: If the debris basket is allowed to become clogged, vacuum performance can deteriorate.**



The clean-water tank filter is located to the front of the battery compartment, and should be checked at regular intervals (Fig.49).

Lift the filter off of the cradle, unscrew the bottom and remove (Fig.50). taking care not to spill any liquid on to the batteries. Rinse using clean water and refit (Fig 51).

Re-assemble the filter and refit into the filter cradle.

**Note: Any Spills should be wiped up before tank is lowered.**



## Changing the Floor-tool Blades



*Always ensure that the machine is switched off prior to any maintenance.*

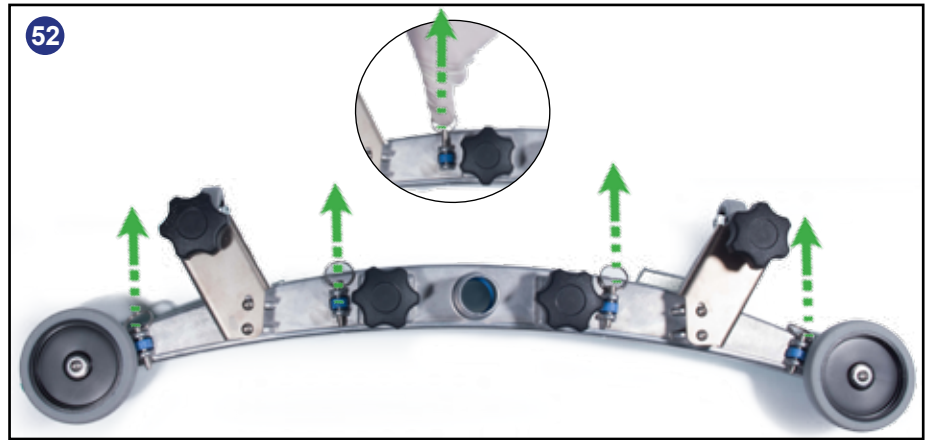

To clean the floor-tool, lower the Floor-tool then unscrew the retaining knobs and slide off of the floor-tool holding bracket. Rinse the floor-tool assembly with clean water and refit.



Periodically the floor-tool blades should be examined and checked for wear and damage. The blade removal is easy. Simply start by removing the four retaining pins (Fig.52), turn the floor-tool over and separate the blade carrier from the body (Fig.53-54). Peel away the blades from their locating lugs (Fig.55) and examine or renew as required. Replacement is a reversal of the removal process.

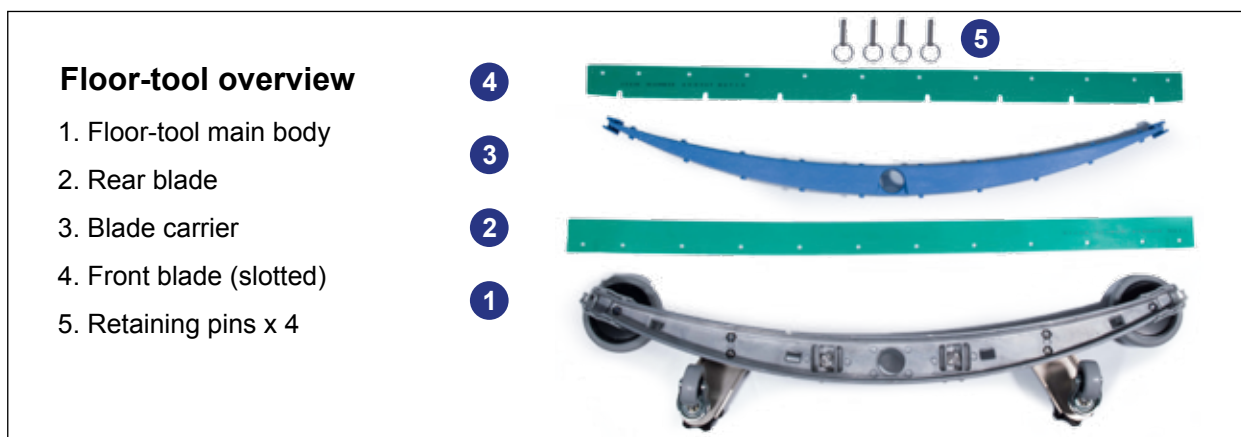

**Note:** *The blades are designed to be reversible, thus extending their useful working life.*

## Floor-tool Height Adjustment

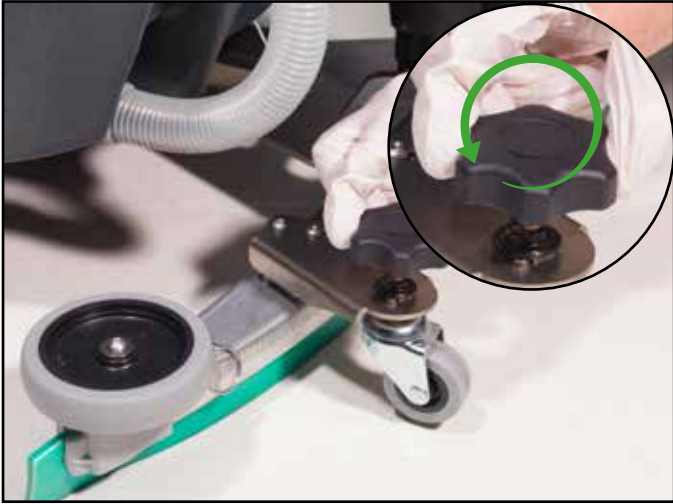

If your machine leaves streaks on the cleaned floor,  
either clean the floor-tool blade (See page 13)  
or  
adjust blade pressure for optimum performance.



# Machine Charging



**Always ensure that the machine is switched off prior to charging.**



The battery charge indicator displays the charge level of the batteries; when fully charged, all meter lights are illuminated.



As the machine is used and the batteries are discharged, the meter lights will go out from right to left.

If the battery-charge level is allowed to discharge to the point that only three red lights are illuminated, the operator must consider charging the machine.



If the battery-charge level is allowed to discharge to the point that only three red lights remain illuminated (and begin to flash), all cleaning functions will automatically be disabled and the operator should drive the machine straight to a suitable charge point.



50-100%



20-50%

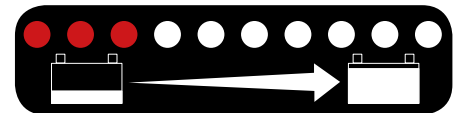

0-20%



The large capacity gel batteries are sealed for life and are totally maintenance free. The on-board charger automatically monitors the charging process and will switch off when the batteries are fully charged.

The machine charging point is located above the foot plate (See page 3 : Item 10).

Insert the charging lead (Fig.56) required for your country into the charging point and connect to a suitable power supply (Fig.57).

**Note: The Charging Lead supplied with your machine may differ than the lead shown.**

Once the charging lead has been connected the red charging indicator will illuminate and the display panel will show 'INHIBITED'.

The battery charge indicator display lights will flash in unison.

The machine will not operate.

To ensure a full charge, the machine should be left until the charging indicator shows green.

Once fully charged, disconnect the charging lead from both the power supply and the machine.

**\*Note**

Charger viewing panel only available on certain models.

See page 21



## Free-wheel Function



**ALWAYS ENSURE THAT THE MACHINE IS ON LEVEL GROUND  
BEFORE DISENGAGING BRAKE ARM.  
NEVER DISENGAGE THE BRAKE WHEN THE MACHINE IS ON A SLOPE / GRADIENT.**



The CRO 8055 is equipped with a free-wheel function that will enable the operator to move the machine.

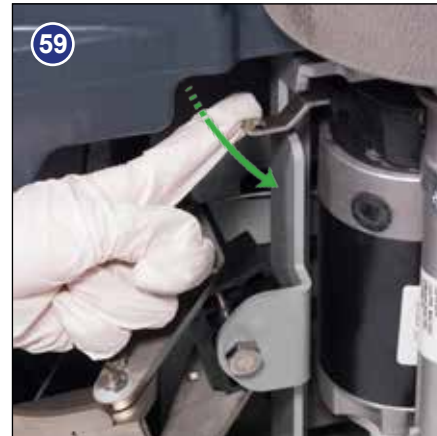

The Free-wheel lever can be found on the right hand side of the rear axle (Fig.58).  
To disengage the brake, pull the lever into the down position (Fig.59).  
Re-engage the brake by moving the lever into the up position.



**When the brake is disengaged the machine is in Free-wheel mode and has no braking facility. Care must be taken when moving the machine in Free-wheel mode.**



## Battery Care

To ensure your machine remains at its maximum efficiency and prolong your battery life, please follow the simple steps below:



### **Under normal daily usage:**

Recharge batteries after each use regardless of machine operation time.





Recharge the machine fully after its last use.

**Do not leave the machine in a discharged state.**

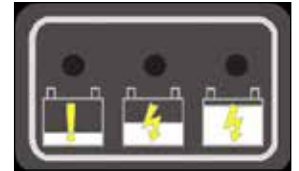
# Battery Care

## Viewing Panel Charging Light Sequence



Signal (LED)		Meaning
	Red LED on	First Phase (constant current Mode)
	Orange LED on	Second Phase (Constant Voltage Mode)
	Green LED on	Third Phase (Constant Voltage Mode) Charge Complete
	Red LED flashing followed by Pause	Cooling Fan Locked > <b>1 flash between pause</b> Over Voltage Protection / Output Short Circuit / Battery Reverse Polarity > <b>2 flashes between pause</b> Over Temperature Protection > <b>3 flashes between pause</b> Charge Time has exceeded 10 hrs during phase 1 or 2 > <b>4 flashes between pause</b>

**\*Note**  
Only available on certain models.

Under abnormal use; i.e. leaving the machine without charging for a period of time, we advise that you follow these steps:



If the machine will be standing unused for a period of 30 days or more, then batteries must be fully charged and battery fuses removed using the Maxi fuse-puller provided, prior to this period.

Batteries should be recharged every three months.  
Charge fully the day before you start using the machine again.

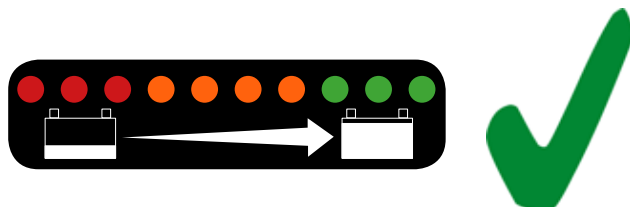

Green Status Indicator	Fault	Possible Cause	Effect on Product	Investigate the Following	Action Required	If Fault Persists
1 Flash with pause 	Batteries voltage low	Batteries not been charged	Operating time severely reduced or machine will not operate	Check when machine last charged	Charge batteries immediately	
		Possible bad connection between batteries, controller, charger or fuses caused by loose connections, damaged wiring, water ingress		Switch OFF the machine : Remove Fuses Check connections to batteries, charger and fuses for loose wires or screws	Tighten loose connections and replace damaged components	
		Not accepting charge due to faulty battery / cell		Check each battery Voltage individually to detect defect unit 10.5V min	Replace batteries as required	
2 Flashes with pause 	Traction motor disconnected	Charger not functioning	The motor will not operate	Check battery voltage and charge current ensuring charger red fault light is extinguished.	Replace charger	
		The motor has a bad connection		Check all connections and leads between motor and controller	Tighten loose connections and replace damaged components.	
		Motor disconnected				
3 Flashes with pause 	Traction motor wiring trip	TCO activated (Thermal Cut Out)	Motor will not operate	Check all connections and leads between the motor and controller		
		Motor failed to open circuit				
		The motor has a short circuit to a battery				
4 Flashes with pause 	Battery Lockout	The battery charge level has fallen below the battery lockout level and the controller is inhibiting machine functions	Machine functions not working	Check battery voltage and charge current ensuring charger red fault light is extinguished	Charge batteries immediately	
		The controller is being inhibited from driving, this may be because the battery charger is connected		Check each battery voltage individually to detect defect unit 10.5V min		
				Remove charger to operate machine		
6 Flashes with pause 	Charger connected	A controller trip is indicated	Machine functions not working	Check all connections and leads	Tighten loose connections and replace damaged components	
		Poor brake connections. Brake failure or deactivation		Check brake wiring and brake lever	Replace brake or wiring as necessary. Reactivate brake by engaging brake lever	
8 Flashes with pause 	Controller trip	Poor connections between battery controller and traction motor	Machine functions not working	Check each battery Voltage individually to ensure voltage < 14 volts		
				Check connections on controller batteries and traction motor		
				Check combined battery pack voltage is < 28 volts		
9 Flashes with pause 	Brake deactivated or failed		Traction drive disabled			
10 Flashes with pause 	High battery voltage		Machine functions not working			

# Trouble Shooting

LCD Display	Fault	Possible Cause	Effect on Product	Investigate the Following	Action Required	If Fault Persists
Blank	* No power	* Key switched off * Emergency stop pressed	* Machine will not operate	* Key switched off * Emergency stop pressed	* Switch key on * Release emergency stop	Contact Service Agent
'OVER CURRENT'	* Brush over current	* Brush pressure too great * Brush current exceeds 32A * Wrong type of brush for surface	* Vac. brush, water & Detergent motors / pump will not operate  * Brush LED's all flash in unison until the Pedal is released	* Release brush pressure * Change type of brush * Restart machine		
'UNDER VOLTS'	* Battery voltage dropped below 21 Volts * Left most battery LED flashes	* Batteries require recharging * Faulty cell on battery	* Machine will not operate	* Battery leads and connections	* Charge batteries * Replace battery (if cell damaged)	
'VAC OVER CURRENT'	* Vacuum motor fault	* Debris entering vacuum motor * Water ingress	* Machine disabled	* Restart machine * Replace vacuum motor		
'INHIBITED'			MACHINE INHIBITED - NO OPERATION			

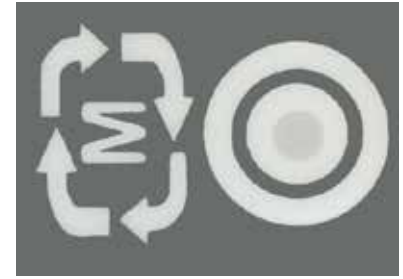

To view CRO 8055 run time information turn the key to the 'ON' position.

Press the run-time information button to cycle between the different modes.

T = Traction run-time

V = Vacuum total run-time

B = Brush total run-time

W = Water Pump total run-time

## Trouble Shooting

<b>PROBLEM</b>	<b>CAUSE</b>	<b>SOLUTION</b>
Machine will not operate	Missing or blown fuses Key in the 'OFF' position Low battery charge Machine stop button in 'OFF' mode Machine is connected and charging	Fit or replace fuse (page 7) Turn key to 'ON' position (page 7) Charge batteries (page 19) Reset stop button (page 12) Take off charge (page 19)
Vacuum will not operate	Floor tool in raised position Waste water tank full	Lower floor-tool (page 8) Empty waste water tank (page 15)
Poor water pick-up	Waste-water tank full Clogged / blocked vacuum hose Loose hose connections Debris basket filter clogged / blocked Separator air filter clogged / blocked Poor separator seal Damaged separator seal Damaged / split vacuum hose Damaged floor-tool blades Low battery charge	Empty waste-water tank (page 15) Remove and clean (page 15) Push tight connections (page 14) Remove and clean (page 16) Remove and clean (Page 15) Clean and refit (page 15) Renew (contact service dept) Renew (contact service dept) Renew (contact service dept) Recharge batteries (page 19)
No brush / scrub function	No brushes fitted Brush deck raised	Check and fit (page 9) Lower brush deck (page 9)
Little or no water flow	Clean-water tank empty Clean-water tank filter blocked/ clogged Incorrect water flow setting Brush deck raised	Fill clean-water tank (page 10) Remove and clean (16) Adjust as desired (Page 11) Lower brush deck (page 9)
Machine just 'stops' while operating	Too much load on the brush system	Reset the machine using the key and decrease the brush load to best suit the floor type (page 12)

## Specifications

<b>Model - CRO 8055</b>							
<i>(Empty) Net Weight</i> 120 A/Hr	<i>Brush Weight</i>	<i>Brush Width</i>	<i>Brush Pressure</i>	<i>Pad Width</i>	<i>Pad Pressure</i>	<i>Brush Motor</i>	<i>Vac motor</i>
<b>200 kg</b>	<b>23 kg</b>	<b>550 mm</b>	<b>11.4 G/cm<sup>2</sup></b>	<b>508 mm</b>	<b>9.3 G/cm<sup>2</sup></b>	<b>24V 600 W</b>	<b>24 V 400 W</b>
<i>Transaxle</i>	<i>Run Time</i> 2 x 120 A/Hr	<i>Run Time</i> 2 x 100 A/Hr	<i>Total Battery Weight</i> 120 A/Hrs	<i>Total Battery Weight</i> 100 A/Hrs	<i>Charge Times</i> 2 x 120 A/Hrs		<i>Charge Times</i> 2 x 100 A/Hrs
<b>24 V 400 W</b>	<b>3 hrs</b>	<b>2 hrs</b>	<b>74 kg (163 lbs)</b>	<b>62 kg (136 lbs)</b>	<b>10A = 12 hrs 20A = 7 hrs 35A = 4.5 hrs</b>		<b>10A = 8 hrs 20A = 5-6 hrs 35A = 3-4 hrs</b>
<i>Brush Speed</i>	<i>AirFlow</i>	<i>Transit Speed</i>	<i>Capacity</i>	<i>Water Flow Rates</i>	<i>Cleaning Area</i>	<i>Sound Pressure</i>	<i>Hand Arm Vibration</i>
<b>150 rpm</b>	<b>24.2 L/sec</b>	<b>0-6 km/hr</b>	<b>80 L / 80 L</b>	<b>0.5 / 1.0 / 1.5 2.0 / 3.0 L/min</b>	<b>1700 m<sup>2</sup> @ 3.5 K/Hr</b>	<b>≤ 70dB (A)</b>	<b>Travelling (Quarry Tiles) 1.84 m/s<sup>2</sup> (Uncertainty 0.92 m/s<sup>2</sup>) ISO 5439-1</b>
<i>Whole Body Vibration</i>		<i>Height</i>	<i>Length</i>		<i>Width</i>		
<b>Travelling (Quarry Tiles) 1.11 m/s<sup>2</sup> (Uncertainty 0.56 m/s<sup>2</sup>) ISO 2431-1</b>		<b>1160 mm</b>	<b>1460 mm</b>		<b>805 mm</b>		



## Spare Parts

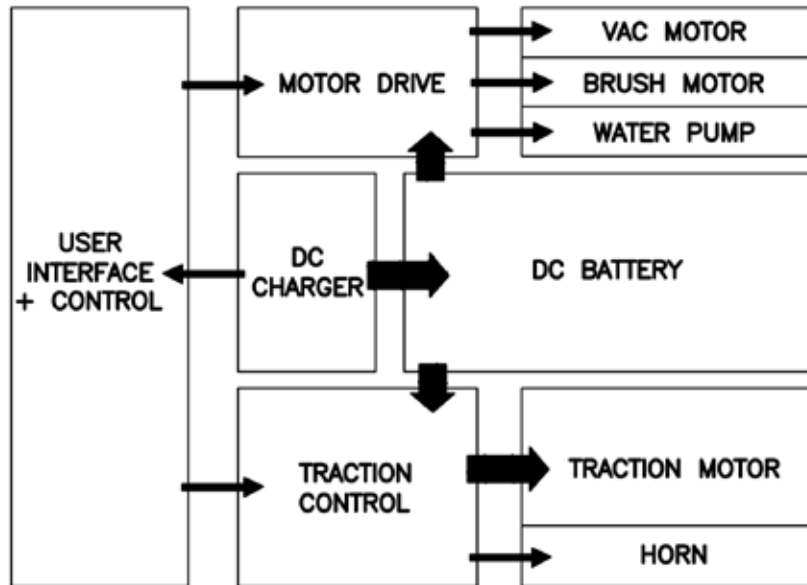

<b>BRUSHES:</b>		<b>TOP TANK:</b>	
<b>606028</b>	550 mm Polyscrub Brush	<b>207000</b>	Grit Filter Basket
<b>606550</b>	550 mm Nyloscrub Brush	<b>208861</b>	Air-Filter
<b>900526</b>	500 mm Nuloc2 Drive Board	<b>208980</b>	Cro Foam Pad
<b>SQUEEGEE:</b>		<b>304503</b>	Separator Seal Strip 1045 mm Long
<b>599469</b>	Complete 650 mm Squeegee Assembly	<b>208862</b>	Seat Pad
<b>900518</b>	Squeegee Blade Set - Serilor PU Green FR & RR	<b>208864</b>	Back Pad
<b>208497</b>	Squeegee Castor	<b>208867</b>	Beacon Light
<b>206953</b>	Detent Pin	<b>208907</b>	Gas Strut (100Nm)
<b>208796</b>	Squeegee Buffer Wheel	<b>220386</b>	Charging Lead V17 - UK
<b>604013</b>	Squeegee Lift Inner Cable Kit	<b>221079</b>	Charging Lead V34 - EURO
<b>208156</b>	M6 Pinch Bolt	<b>BOTTOM TANK &amp; STEERING COLUMN:</b>	
<b>FILTERS:</b>		<b>237685</b>	Bottom Tank Scuff Moulding Left Hand
<b>230278</b>	Water Pump	<b>237684</b>	Bottom Tank Scuff Moulding Right Hand
<b>208888</b>	Extended Filter Complete Assembly	<b>303942</b>	Deck Buffer Wheel
<b>208827</b>	Strainer Black Top	<b>208985</b>	Lift Handle Nylon Guider
<b>208889</b>	Extended Strainer 50 Mesh Screen	<b>392438</b>	Bottle Plate
<b>208830</b>	Strainer Gasket	<b>208897</b>	Steering Drive Belt
<b>208890</b>	68 mm Extended Strainer Clear Bowl	<b>204120</b>	Front Wheel
<b>HOSES:</b>		<b>901209</b>	Rear Wheels
<b>280017</b>	Squeegee Suction Hose	<b>237609</b>	Splash Skirt
<b>237718</b>	3 Ring Hose Guide		
<b>208938</b>	Bottom Tank Dump Hose		
<b>213061</b>	Top Tank Dump Hose		
<b>206842</b>	Filler Stretch Hose		

## Schematic Diagram



*In the event of a breakdown contact your Numatic dealer or the Numatic Technical help line +44 (0)1460 269268*

## EU Declaration of Conformity

 15	<b>EU DECLARATION OF CONFORMITY</b>
We hereby declare under our sole responsibility that the following equipment fulfils all the relevant provisions of the following EU Directives:	
Machinery Directive 2006/42/EC EMC Directive 2004/108/EC RoHS Directive 2011/65/EU	
<b>Machine Description:</b> Type: TTV, TRO, CRO series	<b>Scrubber Dryer</b>
Manufactured by: Numatic International Limited	
Relevant standards upon which conformity is declared include:	
IEC 60335-1 2001 + A1 2004 + A2 2006 + National Deviations IEC 60335-2.72 Ed 2.0  EN 55014-1:2006 EN55014-2:1997+A1 EN61000-3-2:2006 EN61000-3-3:1995+A1+A2 BS EN 62233:2008	
A technical construction file for this equipment is retained at the manufacturer's address under the authorisation of the following signatory:	
Name: Allyn Boyes                      Position: Technical Manager	
Signed: 	Date: 15/06/2015
 Numatic International Limited, Chard, Somerset. TA20 2GB www.numatic.co.uk	
	

# Numatic International Warranty

Numatic International Limited warrant to the original purchaser that its products are free of defects in both material or workmanship for the period shown below:-

Homecare and Cleancare Vacuum cleaners.....	2 Years
Rotary Floor Machines.....	2 Years
Twintec Auto Scrubber Dryer.....	1 Year
Vario Ride-On Scrubber Dryer.....	1 Year / 1500 hours
Mopping, Compacts, Combi and Servocare Products.....	1 Year
Individual Accessories and Spare Parts.....	6 Months

Note: This warranty expressly excludes consumable parts such as carbon brushes, floor brushes, mops, batteries etc, that are considered replaceable from time to time during the normal working life of the machine.

- A. The warranty period commences from the date the goods are purchased.
- B. All warranty claims must be processed through the Dealer from whom the equipment was purchased. The Dealer will co-operate with the purchaser throughout the warranty claims procedure and will arrange any necessary repairs using genuine Numatic parts.
- C. If the original Dealer is no longer able to fulfil his obligations please contact Numatic International Limited with full details of the claim and proof of purchase so that this may be processed without delay.
- D. Any warranty claim can only relate to the specific part that is proven to be at fault and for which a replacement will be supplied but cannot be extended to constitute a claim against the complete machine.
- E. Numatic International will supply the Dealer with any warranty parts required, subject to the claim being validated, after return of the faulty items in accordance with Numatic International Limited's General Conditions of Sale.
- F. Claims will not be accepted if they are the result of fair wear and tear, misuse or abuse of any kind.
- G. No replacement will be given unless the appropriate evidence of the validity of the claim has been provided to the satisfaction of Numatic International Limited.
- H. Numatic International Limited reserve the right to charge for any unnecessary work carried out as a result of an invalid claim.
- I. No variation to this warranty may be made or implied by any member of Numatic International Limited or its Dealers unless such variation is in writing and authorised by the Company



Numatic International Limited, Chard, Somerset, TA20 2GB  
Telephone: 01460 68600 Fax: 01460 68458  
© Numatic International Limited

This machine has been packed  
with the following:

Charging Lead

Fuses

Keys

Signed

CRO 8055/100T  
CRO 8055/120T



This Product has been comprehensively inspected and checked during every stage of its manufacture.  
including an in-depth electrical safety and functionality test.

Distributed by



Numatic International Limited  
Chard, Somerset  
TA20 2GB ENGLAND.  
Telephone 01460 68600 Fax: 01460 68458  
[www.numatic.co.uk](http://www.numatic.co.uk)

Specification subject to change without prior notice  
[www.numatic.co.uk](http://www.numatic.co.uk) © Numatic International Limited