

  
**Nordpeis**





# INNHold

---

S 05-23	PEIS
S 25-27	INNSATS
S 29-35	OVN
<b>S 37-46</b>	<b>TEKNISK OG PRISER</b>

Med bakgrunn i den Norske fyringstradisjonen har vi siden 1984 designet og produsert ildsteder. Med kontinuerlig produktutvikling representerer vårt sortiment stor bredde og variasjon. Kreativitet og bruk av spennende materialer benyttes for å designe våre ildsteder. Vi er stolte av å spre norsk design i store deler av Europa.

Mer informasjon om våre produkter finner du på våre nettsider [www.nordpeis.no](http://www.nordpeis.no).

Du kan trygt handle ildsted basert på utseende og design – vi har tenkt på resten!

Vi gjør oppmerksom på at peisene leveres umalte. Vi tar forbehold om trykkfeil.

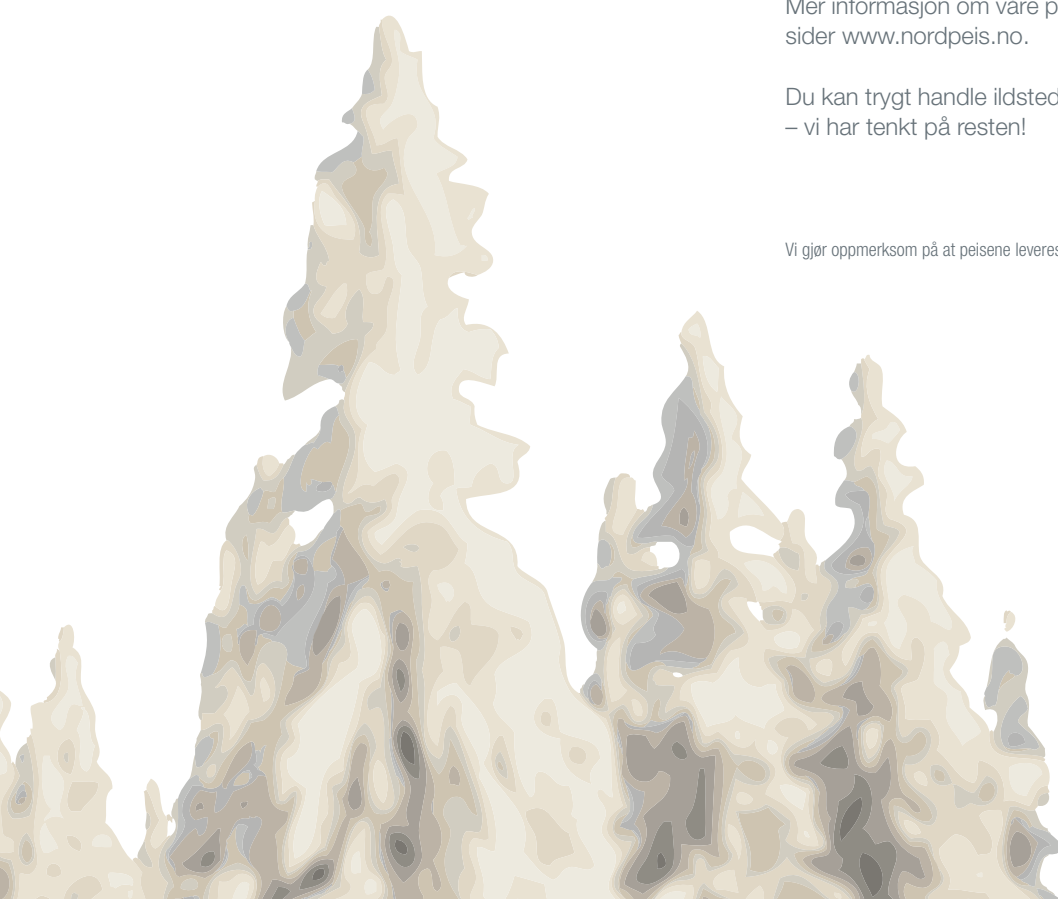



PEIS





# BILBAO

Over / Bilbao 120 med sort vokset betongbelte.  
Gulvplate i grått glass, samt innsats N-20 i krom matt.  
Mål: **H** 1405 mm / **B** 1165 mm / **D** 550 mm

Over / Bilbao 120.  
Gulvplate i sort glass, samt innsats N-20 i krom.  
Mål: **H** 1405 mm / **B** 1165 mm / **D** 550 mm

Høyre / Bilbao 120.  
Gulvplate i grått glass, samt innsats N-20 i krom.  
Mål: **H** 1405 mm / **B** 1165 mm / **D** 550 mm



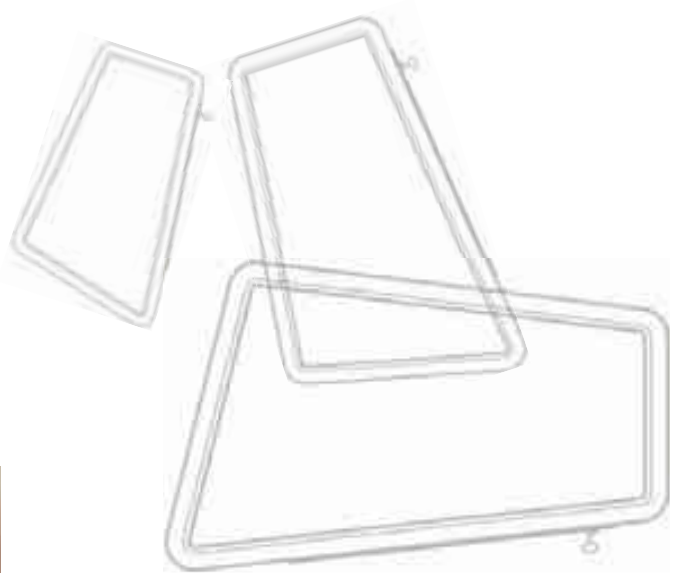



Under / Bilbao 90 med sort vokset betongbelte.  
Gulvplate i sort glass, samt innsats N-20 i krom matt.  
Mål: **H** 1405 mm / **B** 865 mm / **D** 545 mm

Høyre / Bilbao 90.  
Gulvplate i sort glass, sort dekorglass, samt innsats N-20 i krom matt.  
Mål: **H** 1405 mm / **B** 865 mm / **D** 545 mm



# STOCKHOLM



Under / Stockholm med vednisje.

Gulvplate i sort glass, integrert brannmur, samt innsats N-20 i krom.

Mål: **H** 1165 mm / **B** 995 mm / **D** 400 mm

Venstre / Stockholm.

Gulvplate i sort glass, integrert brannmur, samt innsats N-20 i krom.

Mål: **H** 1165 mm / **B** 665 mm / **D** 400 mm





Venstre / Stockholm med vokset betongbelte.  
Gulvplate i sort glass, integrert brannmur, samt innsats N-20 i krom.  
Mål: **H** 1165 mm / **B** 665 mm / **D** 400 mm

Under / Stockholm med vednisje og vokset betongbelte.  
Gulvplate i sort glass, integrert brannmur, samt innsats N-20 i krom.  
Mål: **H** 1165 mm / **B** 995 mm / **D** 400 mm





Over / Amsterdam rettvegg.  
Gulvplate i grått glass, samt innsats N-24 i krom matt.  
Mål: **H** 1380 mm / **B** 1410 mm / **D** 655 mm

Høyre / Amsterdam rettvegg.  
Gulvplate i vokset betong, samt innsats N-24 i krom matt.  
Mål: **H** 1380 mm / **B** 1410 mm / **D** 655 mm

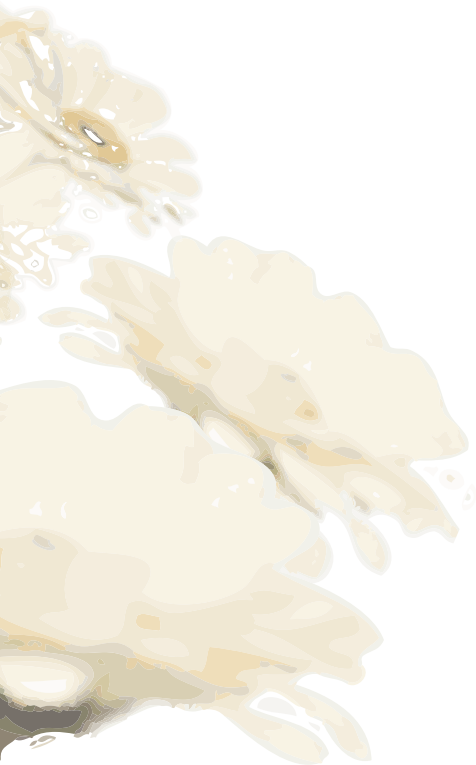

# AMSTERDAM



Under / Amsterdam hjørne.

Gulvplate i grått glass, samt innsats N-24 i krom.

Mål: **H** 1380 mm / **B** 845 mm / **D** 645 mm (eks. vednisje)

Justerbar vednisje, plasseres mot pipe. Maks bredde 530 mm.

Under / Amsterdam hjørne.

Innsats N-24 i krom.

Mål: **H** 1380 mm / **B** 845 mm / **D** 645 mm (eks. vednisje)

Justerbar vednisje, plasseres mot pipe. Maks bredde 530 mm.





Under / Amsterdam hjørne i vokset betong.

Innsats N-24 i krom.

Mål: **H** 1380 mm / **B** 845 mm / **D** 645 mm (eks. vednisje)

Justerbar vednisje, plasseres mot pipe. Maks bredde 530 mm.

Under / Amsterdam hjørne i vokset betong.

Gulvplate i vokset betong, samt innsats N-24 i krom.

Mål: **H** 1380 mm / **B** 845 mm / **D** 645 mm (eks. vednisje)

Justerbar vednisje, plasseres mot pipe. Maks bredde 530 mm.





# BASEL



Over / Basel i vokset betong.  
Ilegg i sort glass, samt innsats N-24 i sort.  
Mål: **H** 2005 mm / **B** 1010 mm / **D** 620 mm

Venstre / Basel.  
Gulvplate og ilegg i hvitt glass, samt innsats N-24 i krom matt.  
Mål: **H** 2005 mm / **B** 1010 mm / **D** 620 mm



Høyre / Basel.  
Gulvplate og ilegg i sort glass, samt innsats N-24 i sort.  
Mål: **H** 2005 mm / **B** 1010 mm / **D** 620 mm



# RONDA



Venstre / Ronda.  
Gulvplate i grått glass.  
Mål: **H** 2010 mm / **B** 600 mm / **D** 600 mm

Høyre / Ronda i vokset betong.  
Mål: **H** 2010 mm / **B** 600 mm / **D** 600 mm

Under / Lugano, vokset betongfront.  
Gulvplate i vokset betong, samt innsats N-27D.  
Mål: **H** 1360 mm / **B** 1400 mm / **D** 610 mm (uten front)

Høyre / Lugano, sort glassfront.  
Gulvplate i sort glass, samt innsats N-27D.  
Mål: **H** 1360 mm / **B** 1400 mm / **D** 610 mm (uten front)

Høyre / Lugano, børstet stålfront.  
Innsats N-27D.  
Mål: **H** 1360 mm / **B** 1400 mm / **D** 610 mm (uten front)



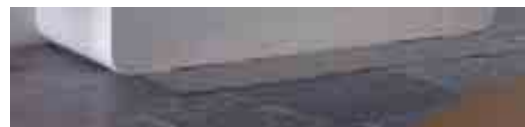

# LUGANO

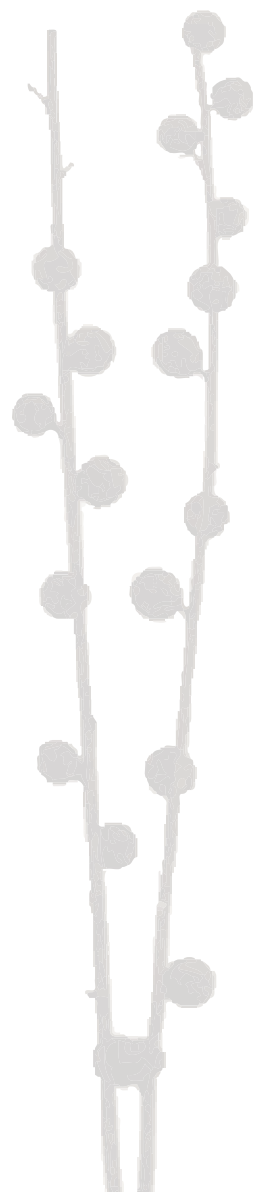





# INNSATS





**Med god forbrenningsteknikk og velisolerte brennkamre gir innsatsene et flott flammebilde og god varme. Den lyse fargen på Thermotten® i brennkammeret holder seg lys ved at soten brennes av ved høy temperatur i brennkammeret.**



#### **Innsats N-24**

N-24 leveres i fire forskjellige farger på dør/dørramme. Luftspyling av glassene for renere glass. Rentbrennende. Muligheter for frisklufttilførsel.



#### **Innsats N-20**

N-20 leveres i fire forskjellige farger på dør/dørramme. Luftspyling av glassene for renere glass. Rentbrennende. Muligheter for frisklufttilførsel.



### Rammer

N-20 og N-24 leveres i fire forskjellige farger på dør/dørramme. Øverst til nederst / Krom matt, krom, antrasitt, sort.

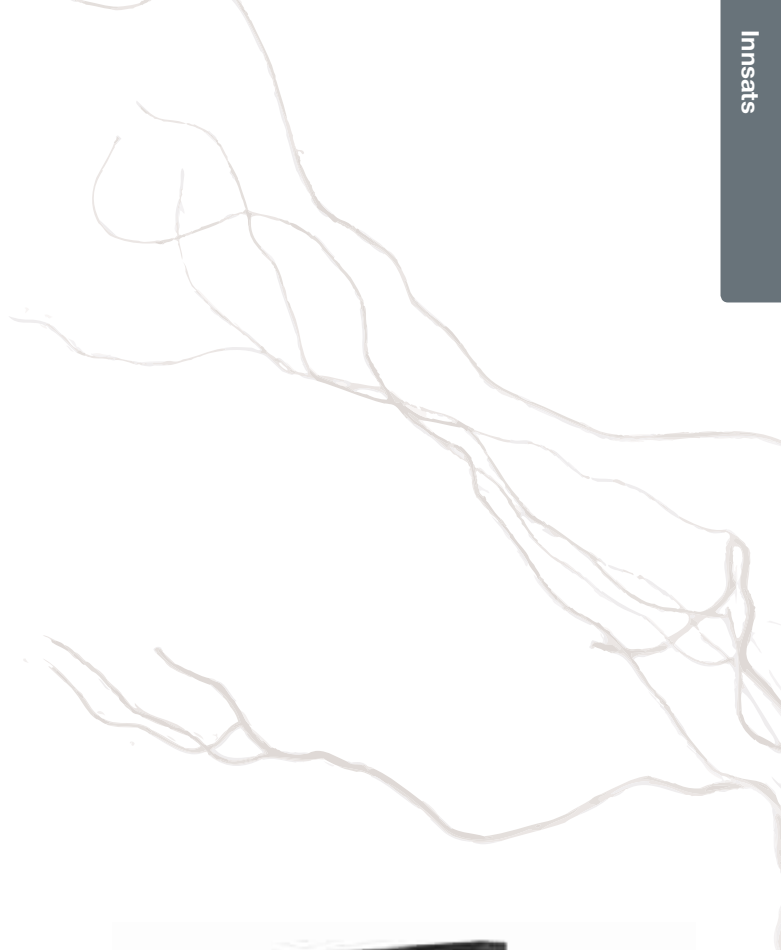

### Innsats N-27D

N-27D har luftspyling av glassene for renere glass. Rentbrennende. Muligheter for frisklufttilførsel. Giliotindøren kan løftes opp for åpen fying. Leveres i sort farge.



OWN



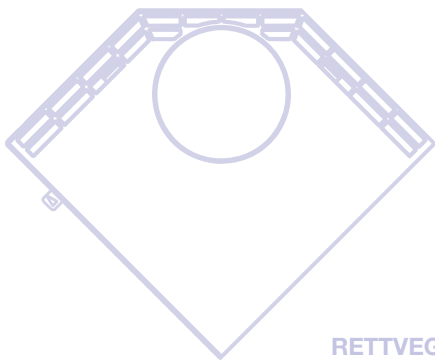

RETTVEGG

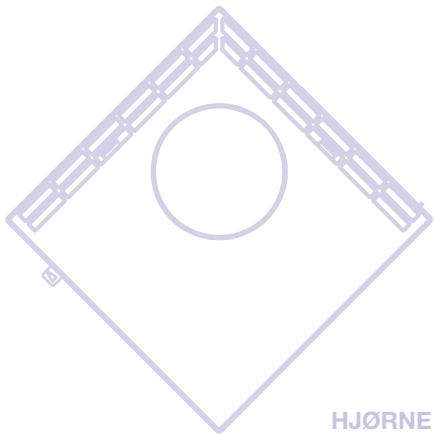

HJØRNE



# QUADRO 1



Over / Quadro 1 rettvegg.  
Pidestall, samt gulvplate i sort glass.  
Mål: **H** 1205 mm / **B** 620 mm / **D** 505 mm

Venstre / Quadro 1 hjørne.  
Pidestall, samt gulvplate i sort glass.  
Mål: **H** 1205 mm / **B** 620 mm / **D** 560 mm

# QUADRO 2







Over / Quadro 2 rettvegg med golvplate i glass.  
Mål: **H** 1205 mm / **B** 545 mm / **D** 440 mm

Venstre / Quadro 2 hjørne.  
Ekstra topelement med varmelagrende olivinsten.  
Mål: **H** 1375 mm / **B** 545 mm / **D** 540 mm



Over / Quadro 3 hjørne.

Gulvplate i sort glass.

Mål: **H** 1335 mm / **B** 545 mm / **D** 540 mm

Høyre / Quadro 3 rettvegg.

Ekstra toppeslement med varmelagrende olivinsten, samt gulvplate i sort glass.

Mål: **H** 1505 mm / **B** 545 mm / **D** 440 mm



# QUADRO 3





# TEKNISK OG PRISER



# PEIS

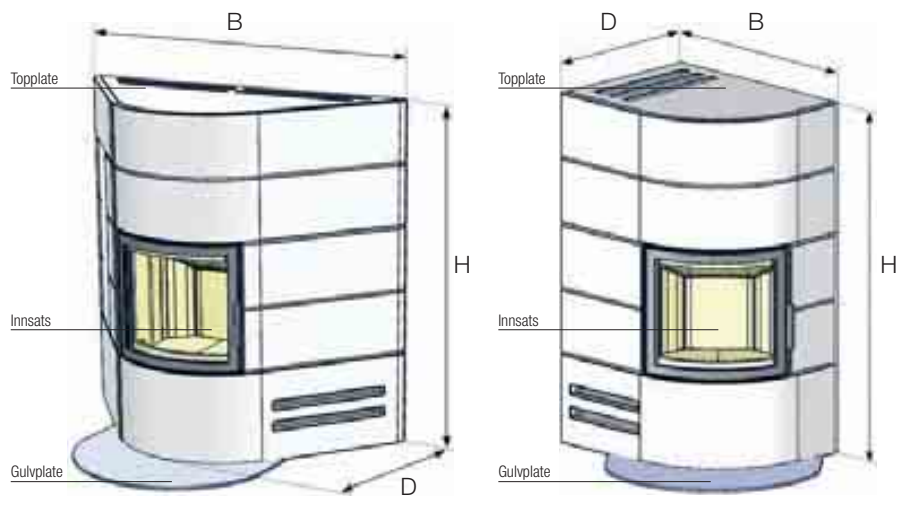

Alle peiser kan topp- og bakmonteres.



## AMSTERDAM HJØRNE

Mål (mm)	Varme (kW)	Vekt (kg) †	I flukt m/vegg*	Utenpå vegg*
H 1380, B 845, D 645**	3-12	349	D 645/ B 845	645 / 845

Innsats	Overflate	Pris peis m/innsats	Innsats	Overflate	Pris peis m/innsats
N-24	Sort / Antrasitt	28 380,-	N-24	Krom / Krom matt	34 360,-

Tilbehør

Gulvplate i vokset betong	2 380,-
Gulvplate i grått glass	2 940,-



## AMSTERDAM HJØRNE, VOKSET BETONG

Mål (mm)	Varme (kW)	Vekt (kg) †	I flukt m/vegg*	Utenpå vegg*
H 1380, B 845, D 645**	3-12	474	D 645/ B 845	645 / 845

Innsats	Overflate	Pris peis m/innsats	Innsats	Overflate	Pris peis m/innsats
N-24	Sort / Antrasitt	36 430,-	N-24	Krom / Krom matt	42 410,-

Tilbehør

Gulvplate i vokset betong	2 380,-
Gulvplate i grått glass	2 940,-



## AMSTERDAM RETTVEGG

Mål (mm)	Varme (kW)	Vekt (kg) †	I flukt m/vegg*	Utenpå vegg*
H 1380, B 1410, D 655	3-12	274	1410	1410

Innsats	Overflate	Pris peis m/innsats	Innsats	Overflate	Pris peis m/innsats
N-24	Sort / Antrasitt	27 380,-	N-24	Krom / Krom matt	33 360,-

Tilbehør

Gulvplate i vokset betong	2 380,-
Gulvplate i grått glass	2 940,-



## AMSTERDAM RETTVEGG, VOKSET BETONG

Mål (mm)	Varme (kW)	Vekt (kg) †	I flukt m/vegg*	Utenpå vegg*
H 1380, B 1410, D 655	3-12	371	1410	1410

Innsats	Overflate	Pris peis m/innsats	Innsats	Overflate	Pris peis m/innsats
N-24	Sort / Antrasitt	32 680,-	N-24	Krom / Krom matt	38 660,-

Tilbehør

Gulvplate i vokset betong	2 380,-
Gulvplate i grått glass	2 940,-



## BASEL

Mål (mm)	Varme (kW)	Vekt (kg) †	Distanse 1**	Distanse 2**
H 2005, B 1010, D 620	3-12	398	100	300

Innsats	Overflate	Pris peis m/innsats	Innsats	Overflate	Pris peis m/innsats
N-24	Sort / Antrasitt	31 310,-	N-24	Krom / Krom matt	37 290,-

## Tilbehør

Ilegg i sort glass	Inkl.
Ilegg i hvitt glass	1 790,-
Gulvplate i sort glass	2 450,-
Gulvplate i hvitt glass	2 450,-

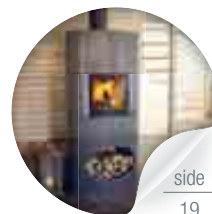

## BASEL VOKSET BETONG

Mål (mm)	Varme (kW)	Vekt (kg) †	Distanse 1**	Distanse 2**
H 2005, B 1010, D 620	3-12	527	100	300

Innsats	Overflate	Pris peis m/innsats	Innsats	Overflate	Pris peis m/innsats
N-24	Sort / Antrasitt	41 180,-	N-24	Krom / Krom matt	47 160,-

## Tilbehør

Ilegg i sort glass	Inkl.
Ilegg i hvitt glass	1 790,-
Gulvplate i sort glass	2 450,-
Gulvplate i hvitt glass	2 450,-

## BILBAO 90

Mål (mm)	Varme (kW)	Vekt (kg) †	I flukt m/vegg*	Utenpå vegg*
H 1405, B 865, D 545	2-10	325	550/680****	470/680

Innsats	Overflate	Pris peis m/innsats	Innsats	Overflate	Pris peis m/innsats
N-20	Sort / Antrasitt	21 110,-***	N-20	Krom / Krom matt	23 590,-***

## Tilbehør

Dekorplate i gult glass	2 500,-
Dekorplate i rødt glass	2 500,-
Dekorplate i grått glass	2 500,-
Dekorplate i sort glass	2 500,-
Gulvplate i gult glass	1 830,-
Gulvplate i rødt glass	1 830,-
Gulvplate i grått glass	1 830,-
Gulvplate i sort glass	1 830,-

## BILBAO 90 VOKSET BETONGBELTE

Mål (mm)	Varme (kW)	Vekt (kg) †	I flukt m/vegg*	Utenpå vegg*
H 1405, B 865, D 545	2-10	327	550/680****	470/680

Innsats	Overflate	Pris peis m/innsats	Innsats	Overflate	Pris peis m/innsats
N-20	Sort / Antrasitt	24 880,-	N-20	Krom / Krom matt	27 360,-

## Tilbehør

Dekorplate i gult glass	2 500,-
Dekorplate i rødt glass	2 500,-
Dekorplate i grått glass	2 500,-
Dekorplate i sort glass	2 500,-
Gulvplate i gult glass	1 830,-
Gulvplate i rødt glass	1 830,-
Gulvplate i grått glass	1 830,-
Gulvplate i sort glass	1 830,-



side  
6

## BILBAO 120

Mål (mm)	Varme (kW)	Vekt (kg) <sup>!</sup>	I flukt m/vegg*	Utenpå vegg*	
H 1405, B 1165, D 550	2-10	429	1050	1050	
Innsats	Overflate	Pris peis m/innsats	Innsats	Overflate	Pris peis m/innsats
N-20	Sort / Antrasitt	22 530,-	N-20	Krom / Krom matt	25 010,-

### Tilbehør

Dekorplate i gult glass	2 500,-
Dekorplate i rødt glass	2 500,-
Dekorplate i grått glass	2 500,-
Dekorplate i sort glass	2 500,-
Gulvplate i gult glass	1 960,-
Gulvplate i rødt glass	1 960,-
Gulvplate i grått glass	1 960,-
Gulvplate i sort glass	1 960,-



side  
6

## BILBAO 120 VOKSET BETONGBELTE

Mål (mm)	Varme (kW)	Vekt (kg) <sup>!</sup>	I flukt m/vegg*	Utenpå vegg*	
H 1405, B 1165, D 550	2-10	431	1050	1050	
Innsats	Overflate	Pris peis m/innsats	Innsats	Overflate	Pris peis m/innsats
N-20	Sort / Antrasitt	26 900,-	N-20	Krom / Krom matt	29 380,-

### Tilbehør

Dekorplate i gult glass	2 500,-
Dekorplate i rødt glass	2 500,-
Dekorplate i grått glass	2 500,-
Dekorplate i sort glass	2 500,-
Gulvplate i gult glass	1 960,-
Gulvplate i rødt glass	1 960,-
Gulvplate i grått glass	1 960,-
Gulvplate i sort glass	1 960,-



side  
22

## LUGANO

Mål (mm)	Varme (kW)	Vekt (kg) <sup>!</sup>	I flukt m/vegg*	Utenpå vegg*
H 1360, B 1400, D 610	6-12	475	1400	1400
Innsats	Overflate	Pris peis m/innsats		
N-27D		38 010,-		

### Tilbehør

Front i sort glass	7 750,-
Front i vokset betong	4 380,-
Front i børstet stål	7 450,-
Gulvplate i sort glass	1 630,-
Gulvplate i børstet stål	1 250,-
Gulvplate i vokset betong	1 630,-



side  
20

## RONDA

Mål (mm)	Varme (kW)	Vekt (kg) <sup>!</sup>	Distanse 1*	Distanse 2*
H 2010, B 600, D 600	4-8	239	100	300
		Innsats	Overflate	Pris peis m/innsats
		NI-26	Støpejern	29 900,-

## Tilbehør

Gulvplate i grått glass	2 350,-
Gulvplate i vokset betong	1 690,-
Varmelagrende Olivinsten (285 kg)	3 980,-
Frisklufttilførsel	1 360,-

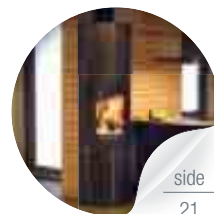
side  
21

## RONDA VOKSET BETONG

Mål (mm)	Varme (kW)	Vekt (kg) <sup>!</sup>	Distanse 1*	Distanse 2*
H 2010, B 600, D 600	4-8	239	100	300
		Innsats	Overflate	Pris peis m/innsats
		NI-26	Støpejern	33 700,-

## Tilbehør

Gulvplate i grått glass	2 350,-
Gulvplate i vokset betong	1 690,-
Varmelagrende Olivinsten (285 kg)	3 980,-
Frisklufttilførsel	1 360,-

side  
10

## STOCKHOLM

Mål uten hylle (mm)	Varme (kW)	Vekt (kg) <sup>!</sup>	Brannmur		
H 1165, B 665, D 400	2-10	189	Integret		
Innsats	Overflate	Pris peis m/innsats	Innsats	Overflate	Pris peis m/innsats
N-20	Sort / Antrasitt	19 780,-	N-20	Krom / Krom matt	22 260,-

## Tilbehør

Vedhylle (B 330 mm)	3 750,-
Gulvplate i sort glass	1 690,-
Gulvplate i vokset betong	1 560,-
Brannmur	Integret

side  
12

## STOCKHOLM VOKSET BETONGBELTE

Mål uten hylle (mm)	Varme (kW)	Vekt (kg) <sup>!</sup>	Brannmur		
H 1165, B 665, D 400	2-10	191	Integret		
Innsats	Overflate	Pris peis m/innsats	Innsats	Overflate	Pris peis m/innsats
N-20	Sort / Antrasitt	23 030,-	N-20	Krom / Krom matt	25 510,-

## Tilbehør

Vedhylle med vokset betongbelte (B 330 mm)	4 950,-
Gulvplate i sort glass	1 690,-
Gulvplate i vokset betong	1 560,-
Brannmur	Integret

# INNSATS

Alle innsatser kan topp- og bakmonteres.

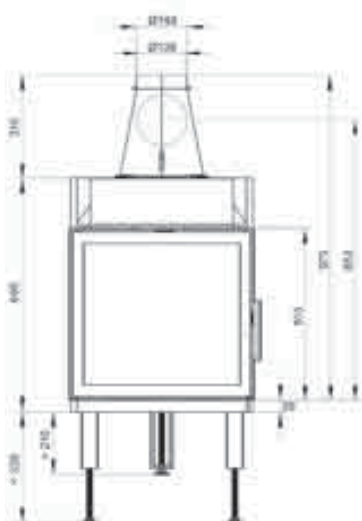
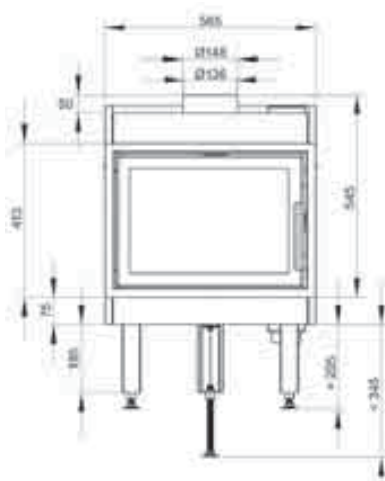
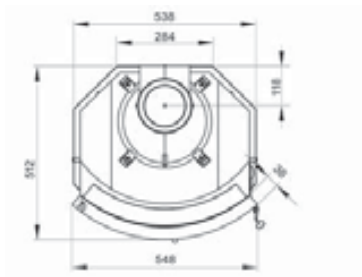
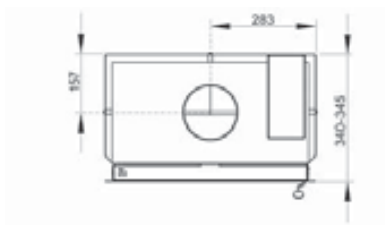

Innsats N-20

Innsats N-24

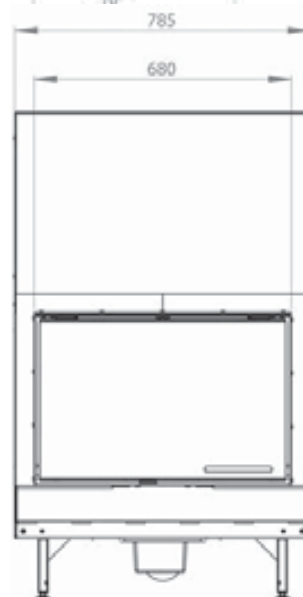
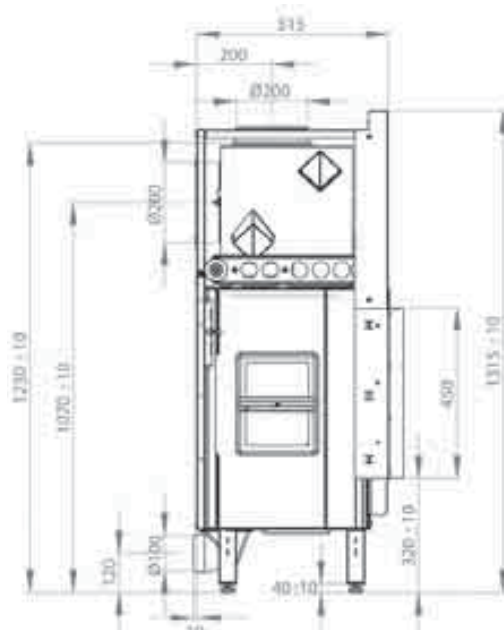

Innsats N-27D



side  
26

## N-20

Trekksystem	Varme (kW)	Vekt (kg)	Vedlengde (mm)	Røykrør Ø (mm)
Topptrekk og opptenningsventil	2-10	86	300	150
Røykuttak	Ca oppvarmingsareal (m <sup>2</sup> )			
Topp	30-150			
Overflate	Pris innsats	Overflate	Pris innsats	
Sort / Antrasitt	11 900,-	Krom / Krom matt	14 380,-	

### Tilbehør

Monteringsett frisklufttilførsel	1 740,-
Gnistfanger	1 500,-
Thermotte	2 790,-



side  
27

## N-24

Trekksystem	Varme (kW)	Vekt (kg)	Vedlengde (mm)	Røykrør Ø (mm)
Topptrekk og opptenningsventil	3-12	120	400	150
Røykuttak	Ca oppvarmingsareal (m <sup>2</sup> )			
Topp, bak og side	45-180			
Overflate	Pris innsats	Overflate	Pris innsats	
Sort / Antrasitt	17 430,-	Krom / Krom matt	23 410,-	

### Tilbehør

Monteringsett frisklufttilførsel	2 080,-
Gnistfanger	2 770,-



side  
26

## N-27D

Trekksystem	Varme (kW)	Vekt (kg)	Vedlengde (mm)	Røykrør Ø (mm)
Topptrekk og opptenningsventil	6-12	230	500	200
Røykuttak	Ca oppvarmingsareal (m <sup>2</sup> )			
Topp og side	90-180			
		Overflate	Pris innsats	
		Sort	24 380,-	

### Merknad!

N-27D er beregnet for større lokaler med et stort energibehov!

OWN

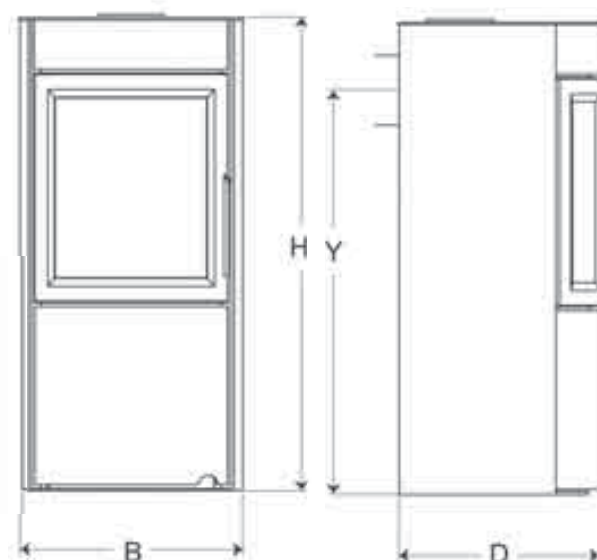
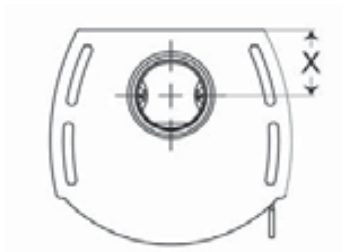

Alle ovner kan topp- og bakmonteres.



side  
31

### QUADRO 1 RETTVEGG

Mål (mm)	Varme (kW)	Vekt (kg)	X (mm)*	Y (mm)*
H 1205, B 620, D 505	3-8	104	105	1045
Vedlengde (mm)	Røykuttak (mm)	Oppvarmingsareal (m <sup>2</sup> )	Pris ovn	
300	150	45-120	18 450,-	

#### Tilbehør

Ekstra topelement med varmelagrende olivinsten (H 166 mm, 14 kg)	1 940,-
Gulvplate i sort glass	1 900,-
Gulvplate i sort glass, stor plate	1 900,-
Monteringsett frisklufttilførsel	1 360,-



side  
30

### QUADRO 1 HJØRNE

Mål (mm)	Varme (kW)	Vekt (kg)	X (mm)*	Y (mm)*
H 1205, B 620, D 560	3-8	104	210	1045
Vedlengde (mm)	Røykuttak (mm)	Oppvarmingsareal (m <sup>2</sup> )	Pris ovn	
300	150	45-120	18 450,-	

#### Tilbehør

Ekstra topelement med varmelagrende olivinsten (H 166 mm, 14 kg)	1 940,-
Gulvplate i sort glass	1 900,-
Gulvplate i sort glass, stor plate	1 900,-
Monteringsett frisklufttilførsel	1 360,-



side  
33

### QUADRO 2 RETTVEGG

Mål (mm)	Varme (kW)	Vekt (kg)	X (mm)*	Y (mm)*
H 1205, B 545, D 440	3-8	113	105	1045
Vedlengde (mm)	Røykuttak (mm)	Oppvarmingsareal (m <sup>2</sup> )	Pris ovn	
300	150	45-120	18 450,-	

#### Tilbehør

Ekstra topelement med varmelagrende olivinsten (H 166 mm, 14 kg)	1 940,-
Gulvplate i sort glass	1 900,-
Gulvplate i sort glass, stor plate	1 900,-
Monteringsett frisklufttilførsel	1 360,-



side  
32

### QUADRO 2 HJØRNE

Mål (mm)	Varme (kW)	Vekt (kg)	X (mm)*	Y (mm)*
H 1205, B 545, D 540	3-8	113	210	1045
Vedlengde (mm)	Røykuttak (mm)	Oppvarmingsareal (m <sup>2</sup> )	Pris ovn	
300	150	45-120	18 450,-	

#### Tilbehør

Ekstra topelement med varmelagrende olivinsten (H 166 mm, 14 kg)	1 940,-
Gulvplate i sort glass	1 900,-
Gulvplate i sort glass, stor plate	1 900,-
Monteringsett frisklufttilførsel	1 360,-



## QUADRO 3 RETTVEGG

Mål (mm)	Varme (kW)	Vekt (kg)	X (mm)*	Y (mm)*
H 1335, B 545, D 440	3-8	118	105	1175
Vedlengde (mm)	Røykuttak (mm)	Oppvarmingsareal (m <sup>2</sup> )	Pris oven	
300	150	45-120	19 900,-	

### Tilbehør

Ekstra topelement med varmelagrende olivinsten (H 166 mm, 14 kg)	1 940,-
Gulvplate i sort glass	1 900,-
Gulvplate i sort glass, stor plate	1 900,-
Monteringsett frisklufttilførsel	1 360,-

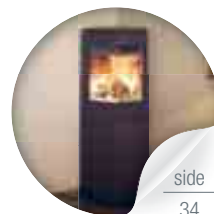

## QUADRO 3 HJØRNE

Mål (mm)	Varme (kW)	Vekt (kg)	X (mm)*	Y (mm)*
H 1335, B 545, D 540	3-8	118	210	1175
Vedlengde (mm)	Røykuttak (mm)	Oppvarmingsareal (m <sup>2</sup> )	Pris oven	
300	150	45-120	19 900,-	

### Tilbehør

Ekstra topelement med varmelagrende olivinsten (H 166 mm, 14 kg)	1 940,-
Gulvplate i sort glass	1 900,-
Gulvplate i sort glass, stor plate	1 900,-
Monteringsett frisklufttilførsel	1 360,-

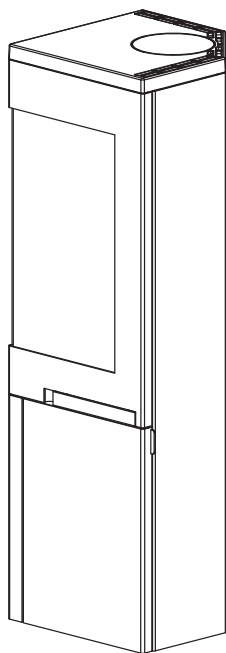
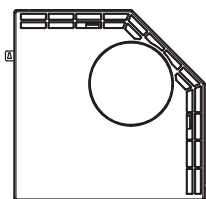

**Quadro: Rettveggsplassering**

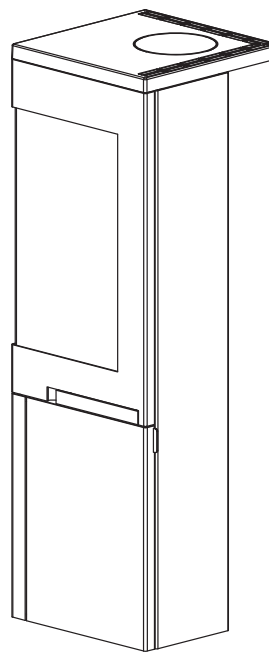
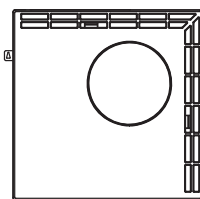

**Quadro: Hjørneplassering**

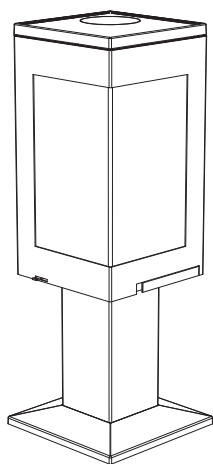

**Quadro 1**

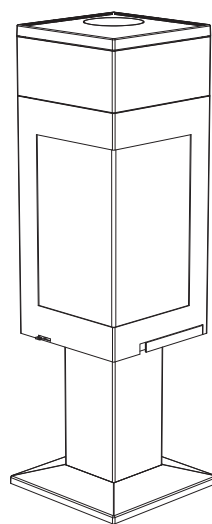

**Quadro 1 med ekstra topplement**

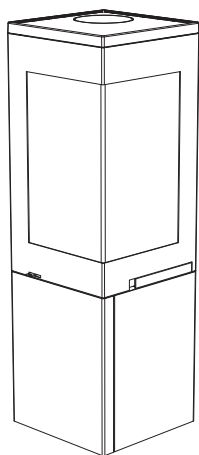

**Quadro 2**

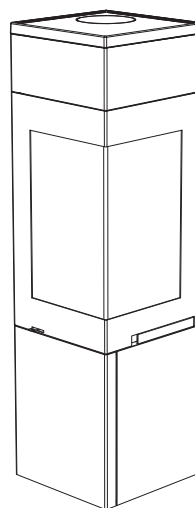

**Quadro 2 med ekstra topplement**

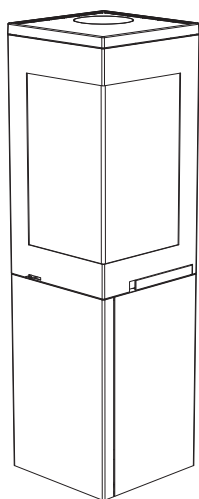

**Quadro 3**

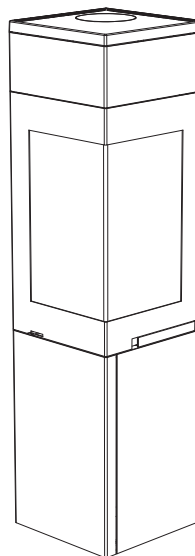

**Quadro 3 med ekstra topplement**



