



Diesel Replacement parts 07/2019

Diesel Ersatzteile

Pièces diesel

Piezas diesel

Diesel Parti

Дизель Запчасти

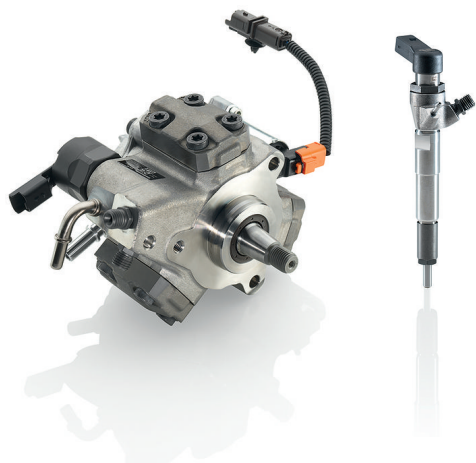









Diesel Replacement parts

07/2019

Diesel Ersatzteile, Pièces diesel, Piezas diesel, Diesel Parti, Дизель Запчасти

	About Us Über uns A propos de nous Acerca de nosotros Chi siamo О нас	2
	Product Overview Produktübersicht Présentation du produit Descripción del producto Panoramica prodotti Обзор Продукта	3
	Product Information Produktinformationen Information produit Información del producto Informazioni sul prodotto Информация О Продукте	7
	Manufacturer Index Herstellerverzeichnis Les fabricants Directorio de fabricantes Elenco produttori Каталог марок и моделей	23
	Product Application Produktverwendungen Utilisations du produit Aplicaciones el producto Usi del prodotto Подбор по автомобилю	27
	Cross-Reference List Referenzliste Liste de référence Lista de referencia Lista di referenze Список Литературы	71
	Symbols and Abbreviations Symbole und Abkürzungen Symboles et abréviations Símbolos y abreviaturas Simboli e abbreviazioni Символы и сокращения	85



Focused on the future

Working with us, you can look forward to good business. With our wide range of leading-edge products and comprehensive distribution network, we are perfectly set up to meet current and future demands. And we're always interested in hearing our partners' ideas and suggestions.

Our innovative capacity and quality as an original equipment manufacturer are available to you in each product in the replacement parts range – for vehicle diagnostics, fuel systems, engine actuators and sensors. It's your guarantee of lasting success in the automotive world of tomorrow.

Das Unternehmen Zukunft

Die Chancen für gemeinsame erfolgreiche Geschäfte stehen gut. Denn mit unserem zukunftsorientierten Produktspektrum und unserem flächendeckenden Vertriebsnetz sind wir für aktuelle wie für kommende Aufgaben erstklassig aufgestellt. Dabei sind für uns die Wünsche und Anregungen unserer Partner jederzeit von großer Bedeutung.

Mit jedem unserer Produkte im Kfz-Ersatzteilebereich – von der Fahrzeugdiagnose über Kraftstoffsysteme und Motorstellenelemente bis hin zu Sensoren – stehen Ihnen die Innovationskraft und Qualität des Erstausrüsters zur Verfügung. Serienmäßig, als langfristige Erfolgsgaranten in der automotiven Welt von morgen.

L'entreprise du futur

Les chances de réaliser ensemble des affaires fructueuses sont bonnes. En effet, avec notre gamme de produits porteuse d'avenir et notre vaste réseau de distribution, nous sommes parfaitement à même d'accomplir les tâches du présent et de l'avenir, d'autant plus que les souhaits et les suggestions de nos partenaires revêtent toujours une grande importance pour nous.

Avec chacun de nos produits du secteur des pièces de rechange pour véhicules – du diagnostic automobile aux capteurs en passant par les circuits de carburant et les éléments de réglage du moteur – vous bénéficiez de la force d'innovation et de la qualité de l'équipementier de première monte. Ces produits de série sont des garants durables du succès dans le monde automobile de demain.

La empresa futura

Se presentan buenas oportunidades para realizar negocios conjuntos colmados de éxito, ya que, con nuestra gama de productos orientada al futuro y nuestra red de distribución de cobertura global, somos los líderes a la hora de llevar a cabo las tareas actuales y venideras. Además, para nosotros, los deseos y las sugerencias de nuestros socios tienen siempre la máxima relevancia.

Con cada uno de nuestros productos del sector de piezas de recambio para el automóvil – desde el diagnóstico del vehículo hasta los sensores, pasando por los sistemas de combustible y los elementos de reglaje del motor –, usted dispone de la fuerza innovadora y la calidad del proveedor de equipo original. De serie, para garantizarle el éxito a largo plazo en el mundo de la automoción del mañana.

Il futuro dell'azienda

Vi sono ottime opportunità di successo per la nostra e vostra attività commerciale. Con la nostra gamma di prodotti di avanzata tecnologia e la nostra ampia rete di distribuzione siamo perfettamente posizionati sia rispetto al presente che al futuro. I suggerimenti e le esigenze dei nostri partners sono per noi sempre di grande importanza.

Tutti i nostri prodotti del settore automotive, dagli apparecchi diagnostici ai sistemi di alimentazione, dagli attuatori motore ai sensori, sono realizzati in modo innovativo e con la elevata qualità propria di una azienda produttrice di sistemi destinati al primo equipaggiamento. Garanzia di successo immediato ed a lungo termine per il settore automobilistico di oggi e di domani.

Предприятие - будущее

Хорошие шансы для успешного совместного бизнеса. Так как с нашим ориентированным на будущее спектром продукции и нашей ширококомасштабной сбытовой сетью мы прекрасно подготовлены к решению текущих и будущих задач. При этом пожелания и предложения партнеров имеют для нас всегда большое значение.

В каждом из наших изделий в области автомобильных запасных деталей, начиная от диагностики автомобилей, топливных систем и исполнительных механизмов и заканчивая датчиками, Вы получаете в Ваше распоряжение инновационную силу и качество изготовителя оригинальных запчастей. Серийно, от гаранта долгосрочного успеха в автомобильном мире завтрашнего дня.



Product Overview

Produktübersicht

Présentation du produit

Descripción del producto

Panoramica prodotti

Обзор Продукта



Common Rail Diesel Injector

Our piezo servo injectors ensure extremely precise injection and ultra-fine atomisation of diesel fuel for highly efficient combustion. Direct-drive piezo injectors make it possible to achieve greater fuel efficiency in powerful engines.

Common Rail Diesel Injektor

Unsere Piezo Servo Injektoren sorgen durch äußerst präzise Einspritzung und feinste Zerstäubung des Dieselmotorkraftstoffs für eine hohe Effizienz in der Verbrennung. Mit den direktangetriebenen Piezo Injektoren können bei leistungsstarken Motoren zusätzliche Potenziale hinsichtlich der effizienten Kraftstoffverbrennung ausgeschöpft werden.

Injecteur diesel common rail

Nos servo-injecteurs piézoélectriques garantissent une efficacité élevée dans la combustion grâce à une injection extrêmement précise et à une pulvérisation très fine du carburant diesel. Avec les injecteurs piézoélectriques à commande directe, des potentiels supplémentaires en matière d'efficacité de combustion du carburant peuvent être exploités sur les moteurs de forte puissance.

Inyector diesel para sistemas Common Rail

Nuestros servoinyectores piezo contribuyen a una elevada eficiencia en la combustión gracias a su inyección extremadamente precisa y la atomización finísima del combustible diésel. Con los inyectores piezo de accionamiento directo pueden aprovecharse nuevos potenciales en cuanto a la combustión eficiente del carburante en los motores de gran potencia.

Iniettor diesel common rail

I nostri iniettori piezoelettrici garantiscono una iniezione di alta precisione ed una fine atomizzazione del carburante diesel per una elevata efficienza della combustione. Con l'azionamento diretto dell'attuatore piezoelettrico dell'iniettore, tutte le condizioni di funzionamento dei moderni potenti motori sono soddisfatte.

Форсунки для систем впрыска с общим нагнетательным трубопроводом типа Common Rail

Наши форсунки с пьезоуправлением благодаря чрезвычайно прецизионному впрыскиванию и мельчайшему распылению дизельного топлива обеспечивают высокую эффективность сгорания. С помощью форсунок Piezo прямого действия можно в мощных двигателях использовать дополнительный потенциал в отношении эффективного сгорания топлива.



Diesel Common Rail Pump

Our high-pressure diesel pumps have been specially developed for the latest generation of common rail diesel injection systems. They enable a compact design and low weight, and are dimensioned for pressures up to 2,500 bar.

Continental's diesel common rail systems offer the following advantages:

- Compliance with current and future emission limits.
- Reduced CO₂ emissions
- Increased performance, with lower fuel consumption and quiet operation

Diesel Common Rail Pumpe

Unsere Diesel Hochdruckpumpen wurden speziell für die neueste Generation der Diesel Common Rail Einspritzsysteme entwickelt. Ihr Konzept ermöglicht eine kompakte Bauweise und ein geringes Gewicht. Die Auslegung unterstützt Drücke bis zu 2.500 bar.

Damit bieten Continentals Diesel Common Rail Systeme folgende Vorteile:

- Einhaltung aktueller und künftiger Abgasgrenzwerte
- Senkung des CO₂-Ausstoßes
- Gesteigerte Leistung bei reduziertem Verbrauch und optimierter Laufruhe



Pompe diesel common rail

Nos pompes haute pression diesel common rail ont été spécialement développées pour la toute dernière génération de systèmes d'injection diesel common rail. Leur conception permet une construction compacte et un faible poids. Leur dimensionnement supporte des pressions jusqu'à 2 500 bars. Ainsi, les systèmes diesel Common Rail de Continental offrent les avantages suivants :

- Respect des valeurs limites actuelles et futures pour les gaz d'échappement.
- Réduction des émissions de CO₂.
- Performances améliorées pour une consommation réduite et une stabilité de marche optimisée.

Bomba diésel para sistemas Common Rail

Nuestras bombas diésel de alta presión fueron especialmente desarrolladas para la última generación de sistemas de inyección diésel Common Rail. Su diseño posibilita una construcción compacta y un peso reducido. La concepción permite presiones de hasta 2.500 bares.

Por esta razón, los sistemas diésel Common Rail de Continental ofrecen las siguientes ventajas:

- El cumplimiento de los límites de emisiones de escape actuales y futuros
- La reducción de la emisión de CO₂
- El incremento de la potencia con consumo reducido y estabilidad de marcha optimizada

Pompe diesel common rail

Le nostre pompe ad alta pressione sono state progettate specificamente per l'ultima generazione di sistemi di iniezione common rail diesel. La loro concezione consente un design compatto ed un basso peso. Sono realizzate per sopportare pressioni sino a 2500 bar.

L'offerta di Continental di sistemi Common Rail garantisce i seguenti vantaggi :

- Conformità ai limiti di emissioni attuali e futuri
- Riduzione delle emissioni di CO₂
- Aumento delle prestazioni, consumi ridotti e funzionamento ottimizzato

Насосы для систем впрыска с общим нагнетательным трубопроводом типа Common Rail

Наши дизельные насосы высокого давления были специально разработаны для новейшего поколения систем впрыска с общим нагнетательным трубопроводом типа Common Rail. Их концепция обеспечивает компактность конструкции и незначительный вес. Расчетное давление составляет до 2.500 бар.

Тем самым системы впрыска с нагнетательным трубопроводом типа Piezo-Common Rail фирмы Continental дают следующие преимущества:

- Соблюдение текущих и будущих предельных показателей выброса ОГ
- Снижение выброса CO₂
- Повышение мощности при снижении расхода и оптимизированный плавный ход

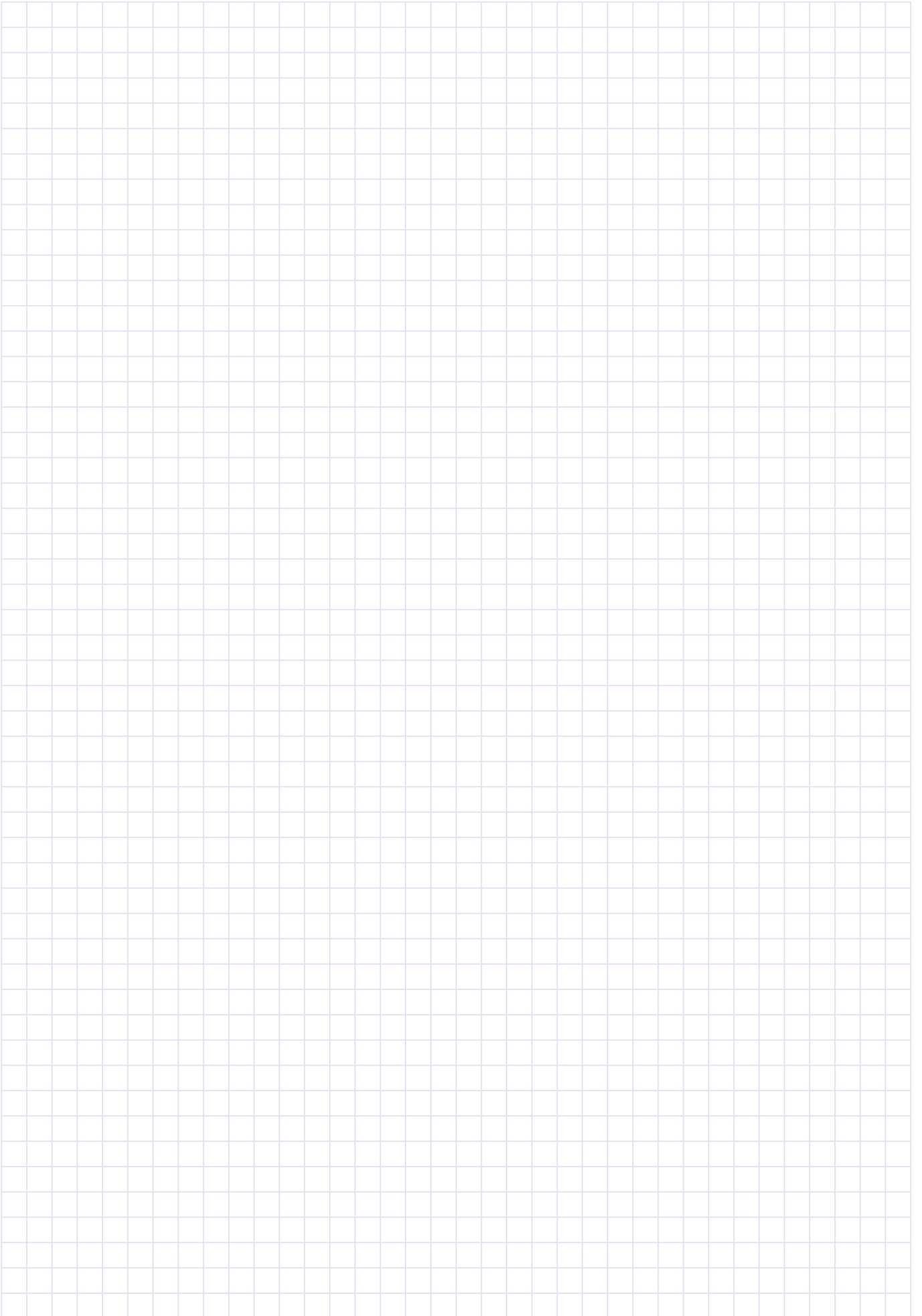



Product Information

Produktinformationen

Information produit

Información del producto

Informazioni sul prodotto

Информация О Продукте



2910000177400

**Common Rail Diesel Injector**

Diesel (V65)

Observe the vehicle manufacturer specifications (C27)

T019: Have to be taught/updated.

T024: Mandatory - check new part against old part (in particular OE No.)

LAND ROVER

DEFENDER Cabrio (L316) / DEFENDER Pickup (L316) / DEFENDER Platform/Chassis (L316) / DEFENDER Station Wagon (L316)

5WS40000-Z

**Common Rail Diesel Injector**

Diesel (V65)

Observe the vehicle manufacturer specifications (C27)

T024: Mandatory - check new part against old part (in particular OE No.)

CITROËN

BERLINGO / BERLINGO FIRST Box (M_) / BERLINGO / BERLINGO FIRST MPV (MF, GJK, GFK) / C5 I (DC_) / C5 I Break (DE_) / XSARA (N1) / XSARA Break (N2) / XSARA Coupe (N0)

PEUGEOT

307 (3A/C) / 307 Break (3E) / 307 SW (3H) / 406 (8B) / 406 Break (8E/F) / PARTNER Box (5) / PARTNER Combispace (5F)

5WS40008-Z

**Diesel Common Rail Pump**

Diesel (V65)

Observe the vehicle manufacturer specifications (C27)

T024: Mandatory - check new part against old part (in particular OE No.)

CITROËN

C2 (JM_) / C2 ENTERPRISE (JG_) / C3 I (FC_, FN_) / C3 II (SC_) / C3 Pluriel (HB_)

FORD

FIESTA V (JH_, JD_) / FIESTA V Van / FIESTA VI (CB1, CCN) / FIESTA VI Van / FUSION (JU_)

PEUGEOT

107 / 1007 (KM_)

TOYOTA

AYGO (_B1_)

5WS40018-Z

**Diesel Common Rail Pump**

Diesel (V65)

Observe the vehicle manufacturer specifications (C27)

T024: Mandatory - check new part against old part (in particular OE No.)

CITROËN

BERLINGO / BERLINGO FIRST Box (M_) / BERLINGO / BERLINGO FIRST MPV (MF, GJK, GFK) / C5 I (DC_) / C5 I Break (DE_) / XSARA (N1) / XSARA Break (N2) / XSARA Coupe (N0)

PEUGEOT

307 (3A/C) / 307 Break (3E) / 307 SW (3H) / 406 (8B) / 406 Break (8E/F) / PARTNER Box (5) / PARTNER Combispace (5F)



5WS40148-Z

**Common Rail Diesel Injector**

Diesel (V65)

Observe the vehicle manufacturer specifications (C27)

T024: Mandatory - check new part against old part (in particular OE No.)

CITROËN
C3 Pluriel (HB_)

FORD
FUSION (JU_)

PEUGEOT
1007 (KM_)

5WS40156-4Z

**Common Rail Diesel Injector**

Version (C2): Class 4

Diesel (V65)

Observe the vehicle manufacturer specifications (C27)

T024: Mandatory - check new part against old part (in particular OE No.)

T041: Please note the classification of the injector (4, 5 or 6).

CITROËN
C4 I (LC_) / C4 Coupe (LA_) / C5 II (RC_) / C5 II Break (RE_)

FIAT
SCUDO (270_, 272_) / SCUDO Box (270_, 272_) / SCUDO Platform/Chassis (270_, 272_) / ULYSSE (179_)

FORD
C-MAX (DM2) / FOCUS II (DA_, HCP, DP) / FOCUS II Convertible / FOCUS II Saloon (DB_, FCH, DH) / FOCUS II Turnier (DA_, FFS, DS) / FOCUS C-MAX (DM2) / GALAXY (WM) / KUGA I / MONDEO IV (BA7) / MONDEO IV Saloon (BA7) / MONDEO IV Turnier (BA7) / S-MAX (WS)

PEUGEOT
307 (3A/C) / 307 Break (3E) / 307 CC (3B) / 307 SW (3H) / 407 (6D_) / 407 Coupe (6C_) / 407 SW (6E_) / 807 (E) / EXPERT Box (VF3A_, VF3U_, VF3X_) / EXPERT Platform/Chassis / EXPERT Tepee (VF3X_)

VOLVO
C30 (533) / C70 II Convertible (542) / S40 II (544) / S80 II (124) / V50 (545) / V70 III (135)



5WS40156-Z

**Common Rail Diesel Injector**

Version (C2): Class 5

Diesel (V65)

Observe the vehicle manufacturer specifications (C27)

T024: Mandatory - check new part against old part (in particular OE No.)

T041: Please note the classification of the injector (4, 5 or 6).

CITROËN

C4 I (LC_) / C4 Coupe (LA_) / C5 II (RC_) / C5 II Break (RE_)

FIAT

SCUDO (270_, 272_) / SCUDO Box (270_, 272_) / SCUDO Platform/Chassis (270_, 272_) / ULYSSE (179_)

FORD

C-MAX (DM2) / FOCUS II (DA_, HCP, DP) / FOCUS II Convertible / FOCUS II Saloon (DB_, FCH, DH) / FOCUS II Turnier (DA_, FFS, DS) / FOCUS C-MAX (DM2) / GALAXY (WM) / KUGA I / MONDEO IV (BA7) / MONDEO IV Saloon (BA7) / MONDEO IV Turnier (BA7) / S-MAX (WS)

PEUGEOT

307 (3A/C) / 307 Break (3E) / 307 CC (3B) / 307 SW (3H) / 407 (6D_) / 407 Coupe (6C_) / 407 SW (6E_) / 607 (9D, 9U) / 807 (E) / EXPERT Box (VF3A_, VF3U_, VF3X_) / EXPERT Platform/Chassis / EXPERT Tepee (VF3X_)

VOLVO

C30 (533) / C70 II Convertible (542) / S40 II (544) / S80 II (124) / V50 (545) / V70 III (135)



5WS40809-Z

**Diesel Common Rail Pump**

Diesel (V65)

Observe the vehicle manufacturer specifications (C27)

T024: Mandatory - check new part against old part (in particular OE No.)

CITROËN

C4 Grand Picasso I (UA_) / C4 Picasso I MPV (UD_) / C5 II (RC_) / C5 II Break (RE_) / C8 (EA_, EB_) / JUMPY (VF7) / JUMPY Box

FIAT

SCUDO (270_, 272_) / SCUDO Box (270_, 272_) / SCUDO Platform/Chassis (270_, 272_) / ULYSSE (179_)

FORD

FOCUS II (DA_, HCP, DP) / FOCUS II Convertible / FOCUS II Saloon (DB_, FCH, DH) / FOCUS II Turnier (DA_, FFS, DS) / FOCUS C-MAX (DM2)

PEUGEOT

307 (3A/C) / 307 Break (3E) / 307 CC (3B) / 307 SW (3H) / 407 (6D_) / 407 Coupe (6C_) / 407 SW (6E_) / 607 (9D, 9U) / 807 (E) / EXPERT Box (VF3A_, VF3U_, VF3X_) / EXPERT Platform/Chassis / EXPERT Tepee (VF3X_)





A2C1283160085

**Diesel Common Rail Pump**

Diesel (V65)

Service exchange part (C121)

Observe the vehicle manufacturer specifications (C27)

T024: Mandatory - check new part against old part (in particular OE No.)

CITROËN

C4 Grand Picasso I (UA_) / C4 Picasso I MPV (UD_) / C5 II (RC_) / C5 II Break (RE_) / C8 (EA_, EB_) / JUMPY (VF7) / JUMPY Box

FIAT

SCUDO (270_, 272_) / SCUDO Box (270_, 272_) / SCUDO Platform/Chassis (270_, 272_) / ULYSSE (179_)

FORD

FOCUS II (DA_, HCP, DP) / FOCUS II Convertible / FOCUS II Saloon (DB_, FCH, DH) / FOCUS II Turnier (DA_, FFS, DS) / FOCUS C-MAX (DM2)

PEUGEOT

307 (3A/C) / 307 Break (3E) / 307 CC (3B) / 307 SW (3H) / 407 (6D_) / 407 Coupe (6C_) / 407 SW (6E_) / 607 (9D, 9U) / 807 (E) / EXPERT Box (VF3A_, VF3U_, VF3X_) / EXPERT Platform/Chassis / EXPERT Tepee (VF3X_)

A2C1283180085

**Diesel Common Rail Pump**

Diesel (V65)

Service exchange part (C121)

Observe the vehicle manufacturer specifications (C27)

T024: Mandatory - check new part against old part (in particular OE No.)

CITROËN

C5 III (RD_) / C5 III Break (RW_) / C6 (TD_)

JAGUAR

S-TYPE (X200) / XF (X250)

LAND ROVER

DISCOVERY III (L319) / RANGE ROVER SPORT (L320)

PEUGEOT

407 (6D_) / 407 Coupe (6C_) / 407 SW (6E_) / 607 (9D, 9U)

A2C1637670080

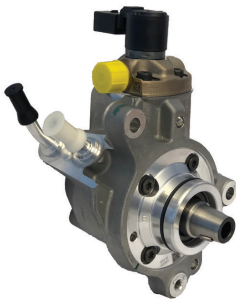
**Diesel Common Rail Pump**

Fuel Mixture Formation (C62): Common Rail (CR)

Diesel (V65)

Observe the vehicle manufacturer specifications (C27)

FORD

TOURNEO CUSTOM Bus / TRANSIT Box / TRANSIT Bus / TRANSIT CUSTOM Box / TRANSIT CUSTOM Bus / TRANSIT Platform/Chassis



A2C5328876880

Distributor Pipe, fuel

 Diesel (V65)

Supplementary Article/Info 2 (C106): with sensor (V178)

Observe the vehicle manufacturer specifications (C27)

T024: Mandatory - check new part against old part (in particular OE No.)

FORD

RANGER (TKE) / TOURNEO CUSTOM Bus / TRANSIT Box / TRANSIT Box (FA_) / TRANSIT Bus / TRANSIT Bus (FD_ , FB_ , FS_ , FZ_ , FC_) / TRANSIT CUSTOM Box / TRANSIT CUSTOM Bus / TRANSIT Platform/Chassis / TRANSIT Platform/Chassis (FM_ , FN_)

A2C5329449880

Cover

for article number (C68): A2C59517047 / A2C59517049

 Black (V52)

A2C59507596



Common Rail Diesel Injector

 Diesel (V65)

Observe the vehicle manufacturer specifications (C27)

T024: Mandatory - check new part against old part (in particular OE No.)

MERCEDES-BENZ

A-CLASS (W176) / B-CLASS (W246, W242) / CITAN Box (415) / CITAN Combi (415) / CITAN Mixto (415) / CLA Coupe (C117) / CLA Shooting Brake (X117) / GLA-CLASS (X156)

NISSAN

JUKE (F15) / NV200 / EVALIA Bus / NV200 Box Body / Estate / QASHQAI II Closed Off-Road Vehicle (J11, J11_)

RENAULT

CAPTUR (J5_ , H5_) / GRAND SCÉNIC III (JZ0/1_) / KADJAR (HA_ , HL_) / KANGOO / GRAND KANGOO (KW0/1_) / KANGOO Express (FW0/1_) / MEGANE III Grandtour (KZ0/1) / MEGANE III Hatchback (BZ0/1_) / SCÉNIC III (JZ0/1_)



A2C59507608

**Diesel Common Rail Pump**

Diesel (V65)

Observe the vehicle manufacturer specifications (C27)

T024: Mandatory - check new part against old part (in particular OE No.)

MERCEDES-BENZ

A-CLASS (W176) / B-CLASS (W246, W242) / CITAN Box (415) / CITAN Combi (415) / CITAN Mixto (415) / CLA Coupe (C117) / CLA Shooting Brake (X117) / GLA-CLASS (X156)

NISSAN

JUKE (F15) / NV200 / EVALIA Bus / NV200 Box Body / Estate / QASHQAI II Closed Off-Road Vehicle (J11, J11_)

RENAULT

CAPTUR (J5_, H5_) / GRAND SCÉNIC III (JZ0/1_) / KADJAR (HA_, HL_) / KANGOO / GRAND KANGOO (KW0/1_) / KANGOO Express (FW0/1_) / MEGANE III Grandtour (KZ0/1) / MEGANE III Hatchback (BZ0/1_) / SCÉNIC III (JZ0/1_)

A2C59511314

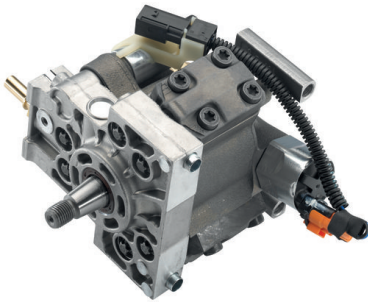
**Diesel Common Rail Pump**

Diesel (V65)

Observe the vehicle manufacturer specifications (C27)

T024: Mandatory - check new part against old part (in particular OE No.)

CITROËN

C5 III (RD_) / C5 III Break (RW_) / C6 (TD_)

JAGUAR

S-TYPE (X200) / XF (X250)

LAND ROVER

DISCOVERY III (L319) / RANGE ROVER SPORT (L320)

PEUGEOT

407 (6D_) / 407 Coupe (6C_) / 407 SW (6E_) / 607 (9D, 9U)

A2C59511316

**Common Rail Diesel Injector**

Diesel (V65)

Observe the vehicle manufacturer specifications (C27)

T024: Mandatory - check new part against old part (in particular OE No.)

CITROËN

C5 III (RD_) / C5 III Break (RW_) / C6 (TD_)

JAGUAR

S-TYPE (X200) / XF (X250)

PEUGEOT

407 (6D_) / 407 Coupe (6C_) / 407 SW (6E_) / 607 (9D, 9U)

A2C59511364

**Common Rail Diesel Injector**

Diesel (V65)

Observe the vehicle manufacturer specifications (C27)

T024: Mandatory - check new part against old part (in particular OE No.)

LAND ROVER

DISCOVERY III (L319) / RANGE ROVER SPORT (L320)



A2C59511600

**Diesel Common Rail Pump**

Diesel (V65)

Observe the vehicle manufacturer specifications (C27)

T024: Mandatory - check new part against old part (in particular OE No.)

FORD

C-MAX (DM2) / FOCUS II (DA_, HCP, DP) / FOCUS II Convertible / FOCUS II Saloon (DB_, FCH, DH) / FOCUS II Turnier (DA_, FFS, DS) / FOCUS C-MAX (DM2) / GALAXY (WM) / KUGA I / MONDEO IV (BA7) / MONDEO IV Saloon (BA7) / MONDEO IV Turnier (BA7) / S-MAX (WS)

VOLVO

C30 (533) / C70 II Convertible (542) / S40 II (544) / S80 II (124) / V50 (545) / V70 III (135)

A2C59511601

**Common Rail Diesel Injector**

Version (C2): Class 6

Diesel (V65)

Observe the vehicle manufacturer specifications (C27)

T024: Mandatory - check new part against old part (in particular OE No.)

T041: Please note the classification of the injector (4, 5 or 6).

CITROËN

C4 I (LC_) / C4 Coupe (LA_) / C5 II (RC_) / C5 II Break (RE_)

FIAT

SCUDO (270_, 272_) / SCUDO Box (270_, 272_) / SCUDO Platform/Chassis (270_, 272_) / ULYSSE (179_)

FORD

C-MAX (DM2) / FOCUS II (DA_, HCP, DP) / FOCUS II Convertible / FOCUS II Saloon (DB_, FCH, DH) / FOCUS II Turnier (DA_, FFS, DS) / FOCUS C-MAX (DM2) / GALAXY (WM) / KUGA I / MONDEO IV (BA7) / MONDEO IV Saloon (BA7) / MONDEO IV Turnier (BA7) / S-MAX (WS)

PEUGEOT

307 (3A/C) / 307 Break (3E) / 307 CC (3B) / 307 SW (3H) / 407 (6D_) / 407 Coupe (6C_) / 407 SW (6E_) / 807 (E) / EXPERT Box (VF3A_, VF3U_, VF3X_) / EXPERT Platform/Chassis / EXPERT Tepee (VF3X_)

A2C59511602

**Common Rail Diesel Injector**

Diesel (V65)

Observe the vehicle manufacturer specifications (C27)

T024: Mandatory - check new part against old part (in particular OE No.)

CITROËN

C8 (EA_, EB_) / JUMPY (VF7) / JUMPY Box

FIAT

SCUDO (270_, 272_) / SCUDO Box (270_, 272_) / SCUDO Platform/Chassis (270_, 272_) / ULYSSE (179_)

PEUGEOT

807 (E) / EXPERT Box (VF3A_, VF3U_, VF3X_) / EXPERT Platform/Chassis / EXPERT Tepee (VF3X_)



A2C59511603

**Common Rail Diesel Injector**

Version (C2): Class M



Diesel (V65)

Observe the vehicle manufacturer specifications (C27)

T024: Mandatory - check new part against old part (in particular OE No.)

T041: Please note the classification of the injector (4, 5 or 6).

CITROËN

C4 I (LC_) / C4 Coupe (LA_) / C4 Grand Picasso I (UA_) / C4 Picasso I MPV (UD_)

PEUGEOT

307 (3A/C) / 307 Break (3E) / 307 CC (3B) / 307 SW (3H) / 407 (6D_) / 407 Coupe (6C_) / 407 SW (6E_)

A2C59511605

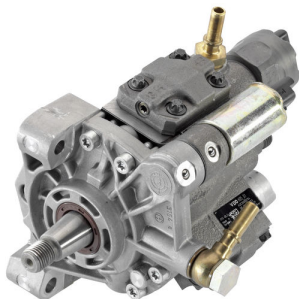
**Diesel Common Rail Pump**

Diesel (V65)

Observe the vehicle manufacturer specifications (C27)

T024: Mandatory - check new part against old part (in particular OE No.)

NISSAN

NOTE (E11, NE11) / QASHQAI / QASHQAI +2 I (J10, NJ10) / TIIDA Hatchback (C11) / TIIDA Saloon (SC11)

RENAULT

CLIO III (BR0/1, CR0/1) / CLIO Grandtour (KR0/1_) / KANGOO / GRAND KANGOO (KW0/1_) / KANGOO BE BOP (KW0/1_) / KANGOO Express (FW0/1_) / LAGUNA III (BT0/1) / LAGUNA III Grandtour (KT0/1) / MEGANE II (BM0/1_, CM0/1_) / MEGANE II Coupé-Cabriolet (EM0/1_) / MEGANE II Estate (KM0/1_) / MEGANE II Saloon (LM0/1_) / MODUS / GRAND MODUS (F/JP0_) / SCÉNIC II (JM0/1_)

A2C59511606

**Common Rail Diesel Injector**

Diesel (V65)

Observe the vehicle manufacturer specifications (C27)

T024: Mandatory - check new part against old part (in particular OE No.)

NISSAN

NOTE (E11, NE11) / QASHQAI / QASHQAI +2 I (J10, NJ10) / TIIDA Hatchback (C11) / TIIDA Saloon (SC11)

RENAULT

CLIO III (BR0/1, CR0/1) / CLIO Grandtour (KR0/1_) / KANGOO / GRAND KANGOO (KW0/1_) / KANGOO BE BOP (KW0/1_) / KANGOO Express (FW0/1_) / LAGUNA III (BT0/1) / LAGUNA III Grandtour (KT0/1) / MEGANE II (BM0/1_, CM0/1_) / MEGANE II Coupé-Cabriolet (EM0/1_) / MEGANE II Estate (KM0/1_) / MEGANE II Saloon (LM0/1_) / MODUS / GRAND MODUS (F/JP0_) / SCÉNIC II (JM0/1_)

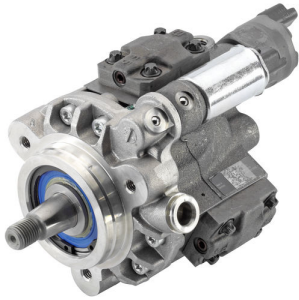

A2C59511609

**Diesel Common Rail Pump**

Diesel (V65)

Observe the vehicle manufacturer specifications (C27)

T024: Mandatory - check new part against old part (in particular OE No.)

FORD

C-MAX (DM2) / FOCUS (DAW, DBW) / FOCUS II (DA_, HCP, DP) / FOCUS II Saloon (DB_, FCH, DH) / FOCUS II Turnier (DA_, FFS, DS) / FOCUS C-MAX (DM2) / FOCUS Saloon (DFW) / FOCUS Turnier (DNW) / GALAXY (WM) / MONDEO IV (BA7) / MONDEO IV Saloon (BA7) / MONDEO IV Turnier (BA7) / S-MAX (WS) / TOURNEO CONNECT / TRANSIT CONNECT (P65_, P70_, P80_)

A2C59511610

**Common Rail Diesel Injector**

Diesel (V65)

Observe the vehicle manufacturer specifications (C27)

T024: Mandatory - check new part against old part (in particular OE No.)

FORD

C-MAX (DM2) / FOCUS (DAW, DBW) / FOCUS II (DA_, HCP, DP) / FOCUS II Saloon (DB_, FCH, DH) / FOCUS II Turnier (DA_, FFS, DS) / FOCUS C-MAX (DM2) / FOCUS Saloon (DFW) / FOCUS Turnier (DNW) / GALAXY (WM) / MONDEO IV (BA7) / MONDEO IV Saloon (BA7) / MONDEO IV Turnier (BA7) / S-MAX (WS) / TOURNEO CONNECT / TRANSIT CONNECT (P65_, P70_, P80_)

A2C59511611

**Common Rail Diesel Injector**

Diesel (V65)

Observe the vehicle manufacturer specifications (C27)

T024: Mandatory - check new part against old part (in particular OE No.)

FORD

TOURNEO CONNECT / TRANSIT CONNECT (P65_, P70_, P80_)

A2C59511612

**Common Rail Diesel Injector**

Diesel (V65)

Observe the vehicle manufacturer specifications (C27)

T024: Mandatory - check new part against old part (in particular OE No.)

CITROËN

C2 (JM_) / C2 ENTERPRISE (JG_) / C3 I (FC_, FN_) / C3 II (SC_)

FORD

FIESTA V (JH_, JD_) / FIESTA V Van / FIESTA VI (CB1, CCN) / FIESTA VI Van / FUSION (JU_)

PEUGEOT

107 / 1007 (KM_)

TOYOTA

AYGO (B1_)



A2C59513481

**Diesel Common Rail Pump**

Diesel (V65)

Observe the vehicle manufacturer specifications (C27)

T024: Mandatory - check new part against old part (in particular OE No.)

LAND ROVER

RANGE ROVER III (L322) / RANGE ROVER SPORT (L320)

A2C59513482

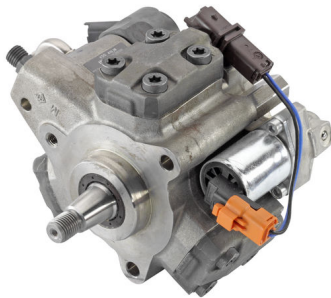
**Diesel Common Rail Pump**

Diesel (V65)

Observe the vehicle manufacturer specifications (C27)

T024: Mandatory - check new part against old part (in particular OE No.)

LAND ROVER

DISCOVERY III (L319) / DISCOVERY IV (L319) / RANGE ROVER SPORT (L320)

A2C59513484

**Common Rail Diesel Injector**

Diesel (V65)

Observe the vehicle manufacturer specifications (C27)

T019: Have to be taught/updated.

T024: Mandatory - check new part against old part (in particular OE No.)

DACIA

DUSTER / DUSTER Box / LODGY (JS_)

NISSAN

CUBE (Z12) / JUKE (F15) / QASHQAI / QASHQAI +2 I (J10, NJ10)

RENAULT

CLIO III (BR0/1, CR0/1) / CLIO Grandtour (KR0/1_) / FLUENCE (L3_) / GRAND SCÉNIC III (JZ0/1_) / LAGUNA Coupe (DT0/1) / LATITUDE (L70_) / MEGANE III Coupe (DZ0/1_) / MEGANE III Grandtour (KZ0/1) / MEGANE III Hatchback (BZ0/1_) / MEGANE CC (EZ0/1_) / SCÉNIC III (JZ0/1_)

A2C59513553

**Common Rail Diesel Injector**

Diesel (V65)

Observe the vehicle manufacturer specifications (C27)

T024: Mandatory - check new part against old part (in particular OE No.)

LAND ROVER

DISCOVERY III (L319) / DISCOVERY IV (L319) / RANGE ROVER SPORT (L320)



A2C59513556

**Common Rail Diesel Injector**

Observe the vehicle manufacturer specifications (C27)

T019: Have to be taught/updated.

T024: Mandatory - check new part against old part (in particular OE No.)

CITROËN

BERLINGO (B9) / BERLINGO Box (B9) / BERLINGO Platform/Chassis (B9) / C3 II (SC_) / C3 Picasso / C4 II (B7) / C4 AIRCROSS / C4 Grand Picasso I (UA_) / C4 Picasso I MPV (UD_) / C4 Picasso II / C5 III (RD_) / C5 III Break (RW_) / DS3 / DS4 / DS5

FORD

C-MAX II (DXA/CB7, DXA/CEU) / FOCUS III / FOCUS III Saloon / FOCUS III Turnier / GALAXY (WM) / GRAND C-MAX (DXA/CB7, DXA/CEU) / MONDEO IV (BA7) / MONDEO IV Turnier (BA7) / S-MAX (WS)

MAZDA

3 (BL) / 3 Saloon (BL) / 5 (CW)

PEUGEOT

207 CC (WD_) / 207 SW (WK_) / 208 (CA_, CC_) / 308 (4A_, 4C_) / 308 II / 308 CC (4B_) / 308 SW (4E_, 4H_) / 508 I (8D_) / 508 SW I (8E_) / 2008 (CU_) / 3008 MPV (OU_) / 4008 / 5008 (OU_, 0E_) / PARTNER Box / PARTNER Tepee

VOLVO

C30 (533) / S40 II (544) / S60 II (134) / S80 II (124) / V40 Hatchback (525, 526) / V50 (545) / V60 (155, 157) / V70 III (135)

A2C59513595

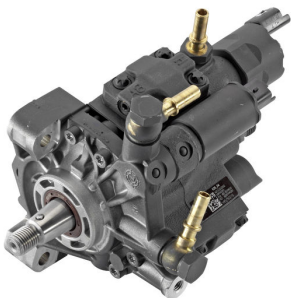
**Diesel Common Rail Pump**

Diesel (V65)

Observe the vehicle manufacturer specifications (C27)

T024: Mandatory - check new part against old part (in particular OE No.)

DACIA

DUSTER / DUSTER Box / LODGY (JS_)

NISSAN

CUBE (Z12) / JUKE (F15) / QASHQAI / QASHQAI +2 I (J10, NJ10)

RENAULT

CLIO III (BR0/1, CR0/1) / CLIO Grandtour (KR0/1_) / FLUENCE (L3_) / GRAND SCÉNIC III (JZ0/1_) / LAGUNA Coupe (DT0/1) / LATITUDE (L70_) / MEGANE III Coupe (DZ0/1_) / MEGANE III Grandtour (KZ0/1) / MEGANE III Hatchback (BZ0/1_) / MEGANE CC (EZ0/1_) / SCÉNIC III (JZ0/1_)

A2C59513596

**Common Rail Diesel Injector**

Diesel (V65)

Observe the vehicle manufacturer specifications (C27)

T024: Mandatory - check new part against old part (in particular OE No.)



A2C59513597

**Common Rail Diesel Injector**

Diesel (V65)

Observe the vehicle manufacturer specifications (C27)

T024: Mandatory - check new part against old part (in particular OE No.)

LAND ROVER

RANGE ROVER III (L322) / RANGE ROVER SPORT (L320)

A2C59513829

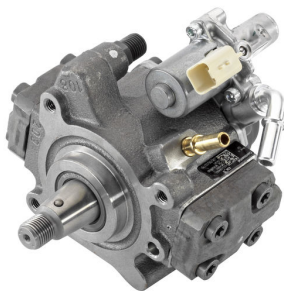
**Diesel Common Rail Pump**

Diesel (V65)

Observe the vehicle manufacturer specifications (C27)

T024: Mandatory - check new part against old part (in particular OE No.)

FORD

C-MAX II (DXA/CB7, DXA/CEU) / FOCUS III / FOCUS III Saloon / FOCUS III Turnier / GALAXY (WM) / GRAND C-MAX (DXA/CB7, DXA/CEU) / MONDEO IV (BA7) / MONDEO IV Turnier (BA7) / S-MAX (WS)

MAZDA

3 (BL) / 3 Saloon (BL) / 5 (CW)

VOLVO

C30 (533) / S40 II (544) / S60 II (134) / S80 II (124) / V40 Hatchback (525, 526) / V50 (545) / V60 (155, 157) / V70 III (135)

A2C59513830

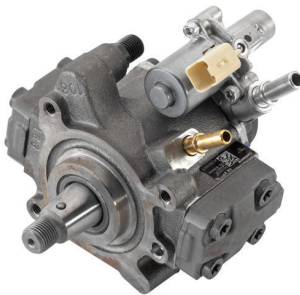
**Diesel Common Rail Pump**

Diesel (V65)

Observe the vehicle manufacturer specifications (C27)

T024: Mandatory - check new part against old part (in particular OE No.)

CITROËN

BERLINGO (B9) / BERLINGO Box (B9) / BERLINGO Platform/Chassis (B9) / C3 II (SC_) / C3 Picasso / C4 II (B7) / C4 AIRCROSS / C4 Grand Picasso I (UA_) / C4 Picasso I MPV (UD_) / C4 Picasso II / C5 III (RD_) / C5 III Break (RW_) / DS3 / DS4 / DS5

PEUGEOT

207 CC (WD_) / 207 SW (WK_) / 208 (CA_, CC_) / 308 (4A_, 4C_) / 308 II / 308 CC (4B_) / 308 SW (4E_, 4H_) / 508 I (8D_) / 508 SW I (8E_) / 2008 (CU_) / 3008 MPV (OU_) / 4008 / 5008 (OU_, 0E_) / PARTNER Box / PARTNER Tepee

A2C59517043

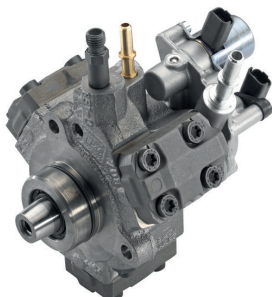
**Diesel Common Rail Pump**

Diesel (V65)

Observe the vehicle manufacturer specifications (C27)

T024: Mandatory - check new part against old part (in particular OE No.)

FORD

RANGER (TKE) / TRANSIT Box (FA_) / TRANSIT Bus (FD_, FB_, FS_, FZ_, FC_) / TRANSIT Platform/Chassis (FM_, FN_) / TRANSIT TOURNEO



A2C59517045

**Diesel Common Rail Pump**

Diesel (V65)

Observe the vehicle manufacturer specifications (C27)

T024: Mandatory - check new part against old part (in particular OE No.)

CITROËN

JUMPER Box / JUMPER Bus / JUMPER Platform/Chassis

FORD

TOURNEO CUSTOM Bus / TRANSIT Box (FA_ _) / TRANSIT Bus (FD_ _, FB_ _, FS_ _, FZ_ _, FC_ _) / TRANSIT CUSTOM Box / TRANSIT CUSTOM Bus / TRANSIT Platform/Chassis (FM_ _, FN_ _)

PEUGEOT

BOXER Box / BOXER Bus / BOXER Platform/Chassis

A2C59517047

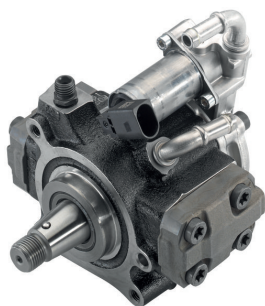
**Diesel Common Rail Pump**

Diesel (V65)

Observe the vehicle manufacturer specifications (C27)

Part number of recommended accessories (C31): A2C5329449880

T024: Mandatory - check new part against old part (in particular OE No.)

AUDI

A1 (8X1, 8XK) / A1 Sportback (8XA, 8XF) / A3 (8P1) / A3 Convertible (8P7) / A3 Sportback (8PA)

SEAT

ALTEA (5P1) / ALTEA XL (5P5, 5P8) / IBIZA IV (6J5, 6P1) / IBIZA IV SPORTCOUPE (6J1, 6P5) / IBIZA IV ST (6J8, 6P8) / LEON (1P1) / TOLEDO IV (KG3)

SKODA

FABIA II (542) / FABIA II Combi (545) / OCTAVIA II (1Z3) / OCTAVIA II Combi (1Z5) / RAPID (NH3) / RAPID Spaceback (NH1) / ROOMSTER (5J) / ROOMSTER Praktik (5J) / SUPERB II (3T4) / SUPERB II Estate (3T5) / YETI (5L)

VW

BEETLE (5C1, 5C2) / BEETLE Convertible (5C7, 5C8) / CADDY III Box (2KA, 2KH, 2CA, 2CH) / CADDY III Estate (2KB, 2KJ, 2CB, 2CJ) / CADDY IV Box (SAA, SAH) / CADDY IV Estate (SAB, SAJ) / GOLF VI (5K1) / GOLF VI Convertible (517) / GOLF VI Variant (AJ5) / GOLF PLUS (5M1, 521) / JETTA III (1K2) / JETTA IV (162, 163, AV3, AV2) / PASSAT (3C2) / PASSAT Variant (3C5) / POLO (6R1, 6C1) / TOURAN (1T3)

A2C59517049

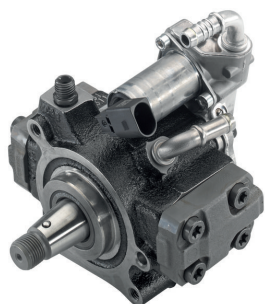
**Diesel Common Rail Pump**

Diesel (V65)

Observe the vehicle manufacturer specifications (C27)

Part number of recommended accessories (C31): A2C5329449880

T024: Mandatory - check new part against old part (in particular OE No.)

AUDI

A1 (8X1, 8XK) / A1 Sportback (8XA, 8XF)

SKODA

RAPID (NH3) / RAPID Spaceback (NH1)

VW

PASSAT (362) / PASSAT Variant (365) / POLO (6R1, 6C1)

**A2C59517051****Common Rail Diesel Injector**

Diesel (V65)

Observe the vehicle manufacturer specifications (C27)

T019: Have to be taught/updated.

T024: Mandatory - check new part against old part (in particular OE No.)

CITROËN

JUMPER Box / JUMPER Bus / JUMPER Platform/Chassis

FORD

RANGER (TKE) / TOURNEO CUSTOM Bus / TRANSIT Box / TRANSIT Box (FA_) / TRANSIT Bus / TRANSIT Bus (FD_, FB_, FS_, FZ_, FC_) / TRANSIT CUSTOM Box / TRANSIT CUSTOM Bus / TRANSIT Platform/Chassis / TRANSIT Platform/Chassis (FM_, FN_) / TRANSIT TOURNEO

PEUGEOT

BOXER Box / BOXER Bus / BOXER Platform/Chassis

A2C8139490080**Common Rail Diesel Injector**

Diesel (V65)

Observe the vehicle manufacturer specifications (C27)

T019: Have to be taught/updated.

T024: Mandatory - check new part against old part (in particular OE No.)

FORD

RANGER (TKE)

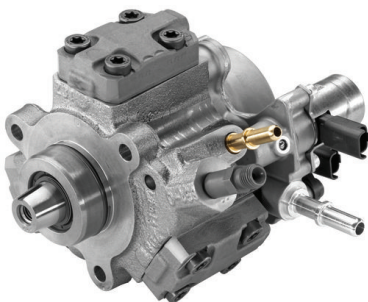
A2C9321760080**Diesel Common Rail Pump**

Diesel (V65)

Observe the vehicle manufacturer specifications (C27)

T024: Mandatory - check new part against old part (in particular OE No.)

FORD

RANGER (TKE)



A2C9626040080

**Common Rail Diesel Injector**

Diesel (V65)

Observe the vehicle manufacturer specifications (C27)

T019: Have to be taught/updated.

T024: Mandatory - check new part against old part (in particular OE No.)

AUDI

A1 (8X1, 8XK) / A1 Sportback (8XA, 8XF) / A3 (8P1) / A3 Convertible (8P7) / A3 Sportback (8PA)

SEAT

ALTEA (5P1) / ALTEA XL (5P5, 5P8) / IBIZA IV (6J5, 6P1) / IBIZA IV SPORTCOUPE (6J1, 6P5) / IBIZA IV ST (6J8, 6P8) / LEON (1P1) / TOLEDO IV (KG3)

SKODA

FABIA II (542) / FABIA II Combi (545) / OCTAVIA II (1Z3) / OCTAVIA II Combi (1Z5) / RAPID (NH3) / ROOMSTER (5J) / ROOMSTER Praktik (5J) / SUPERB II (3T4) / SUPERB II Estate (3T5) / YETI (5L)

VW

BEETLE (5C1, 5C2) / BEETLE Convertible (5C7, 5C8) / CADDY III Box (2KA, 2KH, 2CA, 2CH) / CADDY III Estate (2KB, 2KJ, 2CB, 2CJ) / CADDY IV Box (SAA, SAH) / CADDY IV Estate (SAB, SAJ) / GOLF VI (5K1) / GOLF VI Convertible (517) / GOLF VI Variant (AJ5) / GOLF PLUS (5M1, 521) / JETTA III (1K2) / JETTA IV (162, 163, AV3, AV2) / PASSAT (3C2) / PASSAT (362) / PASSAT Variant (3C5) / PASSAT Variant (365) / POLO (6R1, 6C1) / TOURAN (1T3)





Manufacturer Index

Herstellerverzeichnis

Les fabricants

Directorio de fabricantes

Elenco produttori

Каталог марок и моделей



A					
AUDI	28	FOCUS III	38	PEUGEOT	53
A1 (8X1, 8XK)	28	FOCUS III Saloon	38	1007 (KM_)	57
A1 Sportback (8XA, 8XF)	28	FOCUS III Turnier	39	107	53
A3 (8P1)	28	FOCUS II Saloon (DB_, FCH, DH)	38	2008 (CU_)	57
A3 Convertible (8P7)	28	FOCUS II Turnier (DA_, FFS, DS)	38	207 CC (WD_)	53
A3 Sportback (8PA)	28	FOCUS Saloon (DFW)	39	207 SW (WK_)	53
C		FOCUS Turnier (DNW)	39	208 (CA_, CC_)	53
CITROËN	28	FUSION (JU_)	40	3008 MPV (OU_)	57
BERLINGO / BERLINGO FIRST Box (M_)	28	GALAXY (WM)	40	307 (3A/C)	53
BERLINGO / BERLINGO FIRST MPV (MF, GJK, GFK)	28	GRAND C-MAX (DXA/CB7, DXA/CEU)	40	307 Break (3E)	54
BERLINGO (B9)	29	KUGA I	40	307 CC (3B)	54
BERLINGO Box (B9)	29	MONDEO IV (BA7)	41	307 SW (3H)	54
BERLINGO Platform/Chassis (B9)	29	MONDEO IV Saloon (BA7)	41	308 (4A_, 4C_)	54
C2 (JM_)	29	MONDEO IV Turnier (BA7)	41	308 CC (4B_)	55
C2 ENTERPRISE (JG_)	29	RANGER (TKE)	42	308 II	54
C3 I (FC_, FN_)	29	S-MAX (WS)	42	308 SW (4E_, 4H_)	55
C3 II (SC_)	29	TOURNEO CONNECT	43	4008	57
C3 Picasso	30	TOURNEO CUSTOM Bus	43	406 (8B)	55
C3 Pluriel (HB_)	30	TRANSIT Box	44	406 Break (8E/F)	55
C4 AIRCROSS	30	TRANSIT Box (FA_ _)	44	407 (6D_)	55
C4 Coupe (LA_)	30	TRANSIT Bus	45	407 Coupe (6C_)	56
C4 Grand Picasso I (JA_)	31	TRANSIT Bus (FD_ _, FB_ _, FS_ _, FZ_ _, FC_ _)	45	407 SW (6E_)	56
C4 I (LC_)	30	TRANSIT CONNECT (P65_, P70_, P80_)	46	5008 (OU_, OE_)	57
C4 II (B7)	30	TRANSIT CUSTOM Box	47	508 I (8D_)	56
C4 Picasso II	31	TRANSIT CUSTOM Bus	47	508 SW I (8E_)	56
C4 Picasso I MPV (JD_)	31	TRANSIT Platform/Chassis	47	607 (9D, 9U)	56
C5 I (DC_)	31	TRANSIT Platform/Chassis (FM_ _, FN_ _)	48	807 (E)	57
C5 I Break (DE_)	31	TRANSIT TOURNEO	49	BOXER Box	58
C5 II (RC_)	31	J		BOXER Bus	58
C5 II Break (RE_)	32	JAGUAR	49	BOXER Platform/Chassis	58
C5 III (RD_)	32	S-TYPE (X200)	49	EXPERT Box (VF3A_, VF3U_, VF3X_)	58
C5 III Break (RW_)	32	XF (X250)	49	EXPERT Platform/Chassis	58
C6 (TD_)	32	L		EXPERT Tepee (VF3X_)	59
C8 (EA_, EB_)	32	LAND ROVER	49	PARTNER Box	59
DS3	33	DEFENDER Cabrio (L316)	49	PARTNER Box (5)	59
DS4	33	DEFENDER Pickup (L316)	49	PARTNER Combispace (5F)	59
DS5	33	DEFENDER Platform/Chassis (L316)	49	PARTNER Tepee	59
JUMPER Box	33	DEFENDER Station Wagon (L316)	49	R	
JUMPER Bus	33	DISCOVERY III (L319)	49	RENAULT	59
JUMPER Platform/Chassis	33	DISCOVERY IV (L319)	50	CAPTUR (J5_, H5_)	60
JUMPY (VF7)	34	RANGE ROVER III (L322)	50	CLIO Grandtour (KR0/1_)	60
JUMPY Box	34	RANGE ROVER SPORT (L320)	50	CLIO III (BR0/1, CR0/1)	60
XSARA (N1)	34	M		FLUENCE (L3_)	60
XSARA Break (N2)	34	MAZDA	50	GRAND SCÉNIC III (JZ0/1_)	60
XSARA Coupe (N0)	34	3 (BL)	50	KADJAR (HA_, HL_)	61
D		3 Saloon (BL)	50	KANGOO / GRAND KANGOO (KW0/1_)	61
DACIA	34	5 (CW)	50	KANGOO BE BOP (KW0/1_)	61
DUSTER	34	MERCEDES-BENZ	50	KANGOO Express (FW0/1_)	61
DUSTER Box	35	A-CLASS (W176)	51	LAGUNA Coupe (DT0/1)	61
LODGY (JS_)	35	B-CLASS (W246, W242)	51	LAGUNA III (BT0/1)	61
F		CITAN Box (415)	51	LAGUNA III Grandtour (KT0/1)	61
FIAT	35	CITAN Combi (415)	51	LATITUDE (L70_)	62
SCUDO (270_, 272_)	35	CITAN Mixto (415)	51	MEGANE CC (EZ0/1_)	63
SCUDO Box (270_, 272_)	35	CLA Coupe (C117)	51	MEGANE II (BM0/1_, CM0/1_)	62
SCUDO Platform/Chassis (270_, 272_)	35	CLA Shooting Brake (X117)	51	MEGANE II Coupé-Cabriolet (EM0/1_)	62
ULYSSE (179_)	36	GLA-CLASS (X156)	51	MEGANE II Estate (KM0/1_)	62
FORD	36	N		MEGANE III Coupe (DZ0/1_)	62
C-MAX (DM2)	36	NISSAN	52	MEGANE III Grandtour (KZ0/1)	62
C-MAX II (DXA/CB7, DXA/CEU)	36	CUBE (Z12)	52	MEGANE III Hatchback (BZ0/1_)	63
FIESTA V (JH_, JD_)	36	JUKE (F15)	52	MEGANE II Saloon (LM0/1_)	62
FIESTA VI (CB1, CCN)	37	NOTE (E11, NE11)	52	MODUS / GRAND MODUS (F/JP0_)	63
FIESTA VI Van	37	NV200 / EVALIA Bus	52	SCÉNIC II (JM0/1_)	63
FIESTA V Van	37	NV200 Box Body / Estate	52	SCÉNIC III (JZ0/1_)	63
FOCUS (DAW, DBW)	37	QASHQAI / QASHQAI +2 I (J10, NJ10)	52	S	
FOCUS C-MAX (DM2)	39	QASHQAI II Closed Off-Road Vehicle (J11, J11_)	52	SEAT	63
FOCUS II (DA_, HCP, DP)	37	TIIDA Hatchback (C11)	53	ALTEA (5P1)	63
FOCUS II Convertible	37	TIIDA Saloon (SC11)	53	ALTEA XL (5P5, 5P8)	64
		P		IBIZA IV (6J5, 6P1)	64



IBIZA IV SPORTCOUPE (6J1, 6P5)	64
IBIZA IV ST (6J8, 6P8)	64
LEON (1P1)	64
TOLEDO IV (KG3)	64
SKODA	64
FABIA II (542)	65
FABIA II Combi (545)	65
OCTAVIA II (1Z3)	65
OCTAVIA II Combi (1Z5)	65
RAPID (NH3)	65
RAPID Spaceback (NH1)	65
ROOMSTER (5J)	65
ROOMSTER Praktik (5J)	66
SUPERB II (3T4)	66
SUPERB II Estate (3T5)	66
YETI (5L)	66
T	
TOYOTA	66
AYGO (L_B1_)	66
V	
VOLVO	66
C30 (533)	66
C70 II Convertible (542)	66
S40 II (544)	66
S60 II (134)	67
S80 II (124)	67
V40 Hatchback (525, 526)	67
V50 (545)	67
V60 (155, 157)	67
V70 III (135)	67
VW	67
BEETLE (5C1, 5C2)	67
BEETLE Convertible (5C7, 5C8)	68
CADDY III Box (2KA, 2KH, 2CA, 2CH)	68
CADDY III Estate (2KB, 2KJ, 2CB, 2CJ)	68
CADDY IV Box (SAA, SAH)	68
CADDY IV Estate (SAB, SAJ)	68
GOLF PLUS (5M1, 521)	69
GOLF VI (5K1)	68
GOLF VI Convertible (517)	69
GOLF VI Variant (AJ5)	69
JETTA III (1K2)	69
JETTA IV (162, 163, AV3, AV2)	69
PASSAT (362)	69
PASSAT (3C2)	69
PASSAT Variant (365)	70
PASSAT Variant (3C5)	70
POLO (6R1, 6C1)	70
TOURAN (1T3)	70

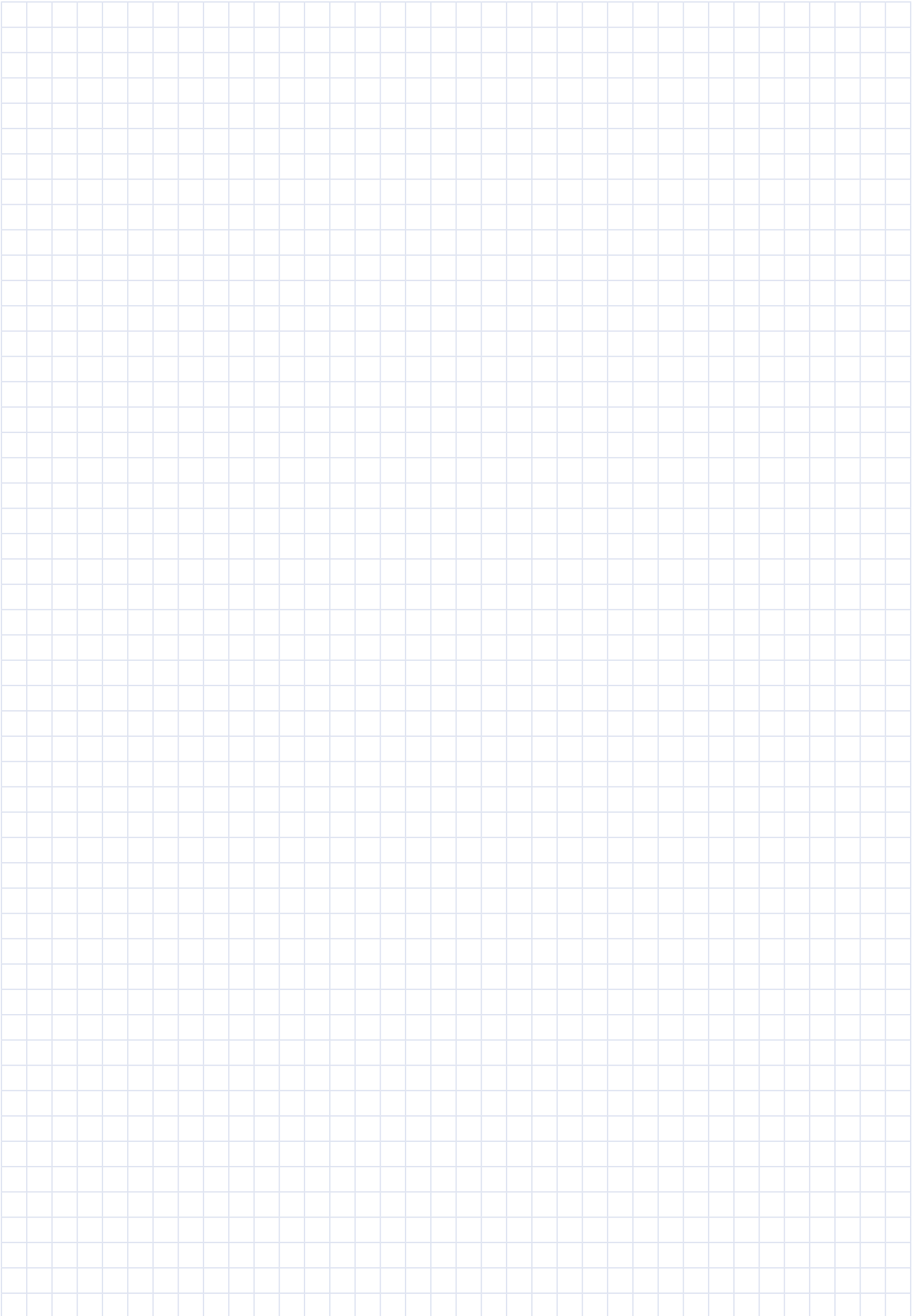



Product Application

Produktverwendungen

Utilisations du produit

Aplicaciones el producto

Usi del prodotto

Подбор по автомобилю



VDO

**AUDI - A1 (8X1, 8XK) 05/10→10/18****Common Rail Diesel Injector**

1.6 TDI	66 kW	03/11→04/15	CAYB	A2C9626040080	22
1.6 TDI	77 kW	05/10→04/15	CAYC	A2C9626040080	22

**Diesel Common Rail Pump**

1.6 TDI	66 kW	03/11→04/15	CAYB	A2C59517049	20
1.6 TDI	77 kW	05/10→04/15	CAYC; 04/15	A2C59517047	20
			CAYC; 05/11 ; Model year to (C21): 2012; for OE number (C61): 03L 906 023KP / 03L 906 023 KQ	A2C59517049	20

AUDI - A1 Sportback (8XA, 8XF) 09/11→10/18**Common Rail Diesel Injector**

1.6 TDI	66 kW	11/11→04/15	CAYB	A2C9626040080	22
---------	-------	-------------	------	----------------------	----

**Diesel Common Rail Pump**

1.6 TDI	66 kW	11/11→04/15	CAYB	A2C59517049	20
1.6 TDI	77 kW	11/11→04/15	CAYC; 04/15	A2C59517047	20
			CAYC; Model year to (C21): 2012; for OE number (C61): 03L 906 023 KP / 03L 906 023 KQ	A2C59517049	20

AUDI - A3 (8P1) 05/03→12/13**Common Rail Diesel Injector**

1.6 TDI	66 kW	05/09→08/12	CAYB	A2C9626040080	22
1.6 TDI	77 kW	05/09→08/12	CAYC	A2C9626040080	22

**Diesel Common Rail Pump**

1.6 TDI	66 kW	05/09→08/12	CAYB	A2C59517047	20
1.6 TDI	77 kW	05/09→08/12	CAYC	A2C59517047	20

AUDI - A3 Convertible (8P7) 04/08→05/13**Common Rail Diesel Injector**

1.6 TDI	77 kW	05/09→05/13	CAYC	A2C9626040080	22
---------	-------	-------------	------	----------------------	----

**Diesel Common Rail Pump**

1.6 TDI	77 kW	05/09→05/13	CAYC	A2C59517047	20
---------	-------	-------------	------	--------------------	----

AUDI - A3 Sportback (8PA) 09/04→12/15**Common Rail Diesel Injector**

1.6 TDI	66 kW	05/09→03/13	CAYB	A2C9626040080	22
1.6 TDI	77 kW	05/09→03/13	CAYC	A2C9626040080	22

**Diesel Common Rail Pump**

1.6 TDI	66 kW	05/09→03/13	CAYB	A2C59517047	20
1.6 TDI	77 kW	05/09→03/13	CAYC	A2C59517047	20

CITROËN - BERLINGO / BERLINGO FIRST Box (M_) 07/96→12/11**Common Rail Diesel Injector**

2.0 HDI 90 (MBRHY, MCRHY)	66 kW	12/99→12/11	RHY (DW10TD)	5WS40000-Z	8
---------------------------	-------	-------------	--------------	-------------------	---

**Diesel Common Rail Pump**

2.0 HDI 90 (MBRHY, MCRHY)	66 kW	12/99→12/11	RHY (DW10TD)	5WS40018-Z	8
---------------------------	-------	-------------	--------------	-------------------	---

CITROËN - BERLINGO / BERLINGO FIRST MPV (MF, GJK, GFK) 07/96→12/11**Common Rail Diesel Injector**

2.0 HDI 90 (MFRHY)	66 kW	12/99→10/05	RHY (DW10TD)	5WS40000-Z	8
--------------------	-------	-------------	--------------	-------------------	---

**Diesel Common Rail Pump**

2.0 HDI 90 (MFRHY)	66 kW	12/99→10/05	RHY (DW10TD)	5WS40018-Z	8
--------------------	-------	-------------	--------------	-------------------	---



CITROËN - BERLINGO (B9) 04/08→					
Common Rail Diesel Injector					
1.6 HDi 110	82 kW	07/10→	9HR (DV6C); 12/11	A2C59513556	18
			9HR (DV6C); 12/11	A2C59513556	18
1.6 HDi 115	84 kW	07/10→	9HR (DV6C); 12/11	A2C59513556	18
Diesel Common Rail Pump					
1.6 HDi 110	82 kW	07/10→	9HR (DV6C)	A2C59513830	19
1.6 HDi 115	84 kW	07/10→			
CITROËN - BERLINGO Box (B9) 04/08→					
Common Rail Diesel Injector					
1.6 HDi 110	82 kW	07/10→	9HR (DV6C); 12/11	A2C59513556	18
			9HR (DV6C); 12/11	A2C59513556	18
1.6 HDi 115	84 kW	07/10→	9HL (DV6C); 12/11	A2C59513556	18
Diesel Common Rail Pump					
1.6 HDi 110	82 kW	07/10→	9HR (DV6C)	A2C59513830	19
1.6 HDi 115	84 kW	07/10→	9HL (DV6C)	A2C59513830	19
CITROËN - BERLINGO Platform/Chassis (B9) 04/08→					
Common Rail Diesel Injector					
1.6 HDi 90 16V	66 kW	04/08→	12/11	A2C59513556	18
			12/11	A2C59513556	18
			03/10 12/11	A2C59513556	18
Diesel Common Rail Pump					
1.6 HDi 90 16V	66 kW	04/08→	07/10	A2C59513830	19
CITROËN - C2 (JM_) 09/03→					
Common Rail Diesel Injector					
1.4 HDi	50 kW	09/03→	8HX (DV4TD)	A2C59511612	16
Diesel Common Rail Pump					
1.4 HDi	50 kW	09/03→	8HX (DV4TD)	5WS40008-Z	8
CITROËN - C2 ENTERPRISE (JG_) 11/03→					
Common Rail Diesel Injector					
1.4 HDi	50 kW	04/09→	8HX (DV4TD)	A2C59511612	16
Diesel Common Rail Pump					
1.4 HDi	50 kW	04/09→	8HX (DV4TD)	5WS40008-Z	8
CITROËN - C3 I (FC_, FN_) 02/02→					
Common Rail Diesel Injector					
1.4 HDi	50 kW	02/02→	8HX (DV4TD)	A2C59511612	16
Diesel Common Rail Pump					
1.4 HDi	50 kW	02/02→	8HX (DV4TD)	5WS40008-Z	8
CITROËN - C3 II (SC_) 11/09→					
Common Rail Diesel Injector					
1.4 HDi 70	50 kW	11/09→	8HZ (DV4TD)	A2C59511612	16
1.6 HDi 110	82 kW	11/09→	9HR (DV6C); 12/11	A2C59513556	18
			9HR (DV6C); 12/11	A2C59513556	18
			9HR (DV6C); 03/10 12/11	A2C59513556	18
1.6 HDi 115	84 kW	09/12→		A2C59513556	18
Diesel Common Rail Pump					
1.4 HDi 70	50 kW	11/09→	8HZ (DV4TD)	5WS40008-Z	8



VDO

**CITROËN - C3 II (SC_) 11/09→****Diesel Common Rail Pump**

1.6 HDi 110	82 kW	11/09→	9HR (DV6C); 07/10	A2C59513830	19
1.6 HDi 115	84 kW	09/12→	9HR (DV6C); 06/10	A2C59513830	19
				A2C59513830	19

CITROËN - C3 Picasso 02/09→**Common Rail Diesel Injector**

1.6 HDi 110	82 kW	05/10→	9HR (DV6C); 12/11	A2C59513556	18
			9HR (DV6C); 12/11	A2C59513556	18
1.6 HDi 115	84 kW	01/13→	9HL (DV6C)	A2C59513556	18

**Diesel Common Rail Pump**

1.6 HDi 110	82 kW	05/10→	9HR (DV6C); 07/10	A2C59513830	19
			9HR (DV6C); 06/10	A2C59513830	19
1.6 HDi 115	84 kW	01/13→	9HL (DV6C)	A2C59513830	19

CITROËN - C3 Pluriel (HB_) 05/03→**Common Rail Diesel Injector**

1.4 HDi	50 kW	04/04→	8HX (DV4TD)	5WS40148-Z	9
---------	-------	--------	-------------	-------------------	---

**Diesel Common Rail Pump**

1.4 HDi	50 kW	04/04→	8HX (DV4TD)	5WS40008-Z	8
---------	-------	--------	-------------	-------------------	---

CITROËN - C4 I (LC_) 11/04→12/13**Common Rail Diesel Injector**

2.0 HDi	100 kW	11/04→07/11	RHR (DW10BTED4)	A2C59511603	15
2.0 HDi	103 kW	07/08→07/11	RHF (DW10BTED4); Version (C2): Class 4	5WS40156-4Z	9
				5WS40156-Z	10
			RHF (DW10BTED4); Version (C2): Class 6	A2C59511601	14
			RHF (DW10BTED4); Version (C2): Class M	A2C59511603	15

CITROËN - C4 II (B7) 02/09→**Common Rail Diesel Injector**

1.6 HDi 110	82 kW	11/09→	9HR (DV6C); 12/11	A2C59513556	18
			9HR (DV6C); 12/11	A2C59513556	18
			9HR (DV6C); 03/10 12/11	A2C59513556	18
1.6 HDi 115	84 kW	07/12→	9HR (DV6C)	A2C59513556	18

**Diesel Common Rail Pump**

1.6 HDi 110	82 kW	11/09→	9HR (DV6C); 07/10	A2C59513830	19
1.6 HDi 115	84 kW	07/12→	9HR (DV6C)	A2C59513830	19

CITROËN - C4 AIRCROSS 08/10→**Common Rail Diesel Injector**

1.6 HDi 115	84 kW	04/12→	9HL (DV6C)	A2C59513556	18
1.6 HDi 115 AWC	84 kW	05/12→			

**Diesel Common Rail Pump**

1.6 HDi 115	84 kW	04/12→	9HL (DV6C)	A2C59513830	19
1.6 HDi 115 AWC	84 kW	05/12→			

CITROËN - C4 Coupe (LA_) 11/04→12/13**Common Rail Diesel Injector**

2.0 HDi	100 kW	11/04→12/10	RHR (DW10BTED4)	A2C59511603	15
2.0 HDi	103 kW	07/08→07/11	RHF (DW10BTED4); Version (C2): Class 4	5WS40156-4Z	9
				5WS40156-Z	10
			RHF (DW10BTED4); Version (C2): Class 6	A2C59511601	14
			RHF (DW10BTED4); Version (C2): Class M	A2C59511603	15



VDO

CITROËN - C4 Grand Picasso I (UA_) 10/06→12/13

Common Rail Diesel Injector

1.6 HDi 110	82 kW	09/10→08/13	9HR (DV6C); 12/11	A2C59513556	18
			9HR (DV6C); 12/11	A2C59513556	18
2.0 HDi 138	100 kW	10/06→12/13	RHJ (DW10BTED4) / RHR (DW10BTED4)	A2C59511603	15

Diesel Common Rail Pump

1.6 HDi 110	82 kW	09/10→08/13	9HR (DV6C)	A2C59513830	19
2.0 HDi 138	100 kW	10/06→12/13	RHJ (DW10BTED4)	5WS40809-Z	10
			RHR (DW10BTED4)	5WS40809-Z	10
			RHJ (DW10BTED4); Service exchange part (C121)	A2C1283160085	11
			RHR (DW10BTED4); Service exchange part (C121)	A2C1283160085	11

CITROËN - C4 Picasso I MPV (UD_) 10/06→12/15

Common Rail Diesel Injector

1.6 HDi 110	82 kW	09/10→08/13	9HR (DV6C); 12/11	A2C59513556	18
			9HR (DV6C); 12/11	A2C59513556	18
2.0 HDi 138	100 kW	10/06→08/13	RHJ (DW10BTED4) / RHR (DW10BTED4)	A2C59511603	15

Diesel Common Rail Pump

1.6 HDi 110	82 kW	09/10→08/13	9HR (DV6C)	A2C59513830	19
2.0 HDi 138	100 kW	10/06→08/13	RHJ (DW10BTED4)	5WS40809-Z	10
			RHR (DW10BTED4)	5WS40809-Z	10
			RHJ (DW10BTED4); Service exchange part (C121)	A2C1283160085	11
			RHR (DW10BTED4); Service exchange part (C121)	A2C1283160085	11

CITROËN - C4 Picasso II 01/13→

Common Rail Diesel Injector

1.6 HDi / BlueHDi 115	85 kW	02/13→		A2C59513556	18
-----------------------	-------	--------	--	-------------	----

Diesel Common Rail Pump

1.6 HDi / BlueHDi 115	85 kW	02/13→		A2C59513830	19
-----------------------	-------	--------	--	-------------	----

CITROËN - C5 I (DC_) 03/01→03/05

Common Rail Diesel Injector

2.0 HDi (DCRHYB)	66 kW	03/01→08/04	RHY (DW10TD)	5WS40000-Z	8
------------------	-------	-------------	--------------	------------	---

Diesel Common Rail Pump

2.0 HDi (DCRHYB)	66 kW	03/01→08/04	RHY (DW10TD)	5WS40018-Z	8
------------------	-------	-------------	--------------	------------	---

CITROËN - C5 I Break (DE_) 06/01→09/04

Common Rail Diesel Injector

2.0 HDi (DERHYB)	66 kW	06/01→08/04	RHY (DW10TD)	5WS40000-Z	8
------------------	-------	-------------	--------------	------------	---

Diesel Common Rail Pump

2.0 HDi (DERHYB)	66 kW	06/01→08/04	RHY (DW10TD)	5WS40018-Z	8
------------------	-------	-------------	--------------	------------	---

CITROËN - C5 II (RC_) 08/04→

Common Rail Diesel Injector

2.0 HDi (RCRHRH)	100 kW	09/04→	RHR (DW10BTED4); Version (C2): Class 4	5WS40156-4Z	9
			RHR (DW10BTED4); Version (C2): Class 4	5WS40156-Z	10
			RHR (DW10BTED4); Version (C2): Class 6	A2C59511601	14

Diesel Common Rail Pump

2.0 HDi (RCRHRH)	100 kW	09/04→		5WS40809-Z	10
			Service exchange part (C121)	A2C1283160085	11



VDO

**CITROËN - C5 II Break (RE_) 09/04→****Common Rail Diesel Injector**

2.0 HDi (RERHRH)	100 kW	09/04→	RHR (DW10BTED4); Version (C2): Class 4	5WS40156-4Z	9
				5WS40156-Z	10
			RHR (DW10BTED4); Version (C2): Class 6	A2C59511601	14

**Diesel Common Rail Pump**

2.0 HDi (RERHRH)	100 kW	09/04→		5WS40809-Z	10
			Service exchange part (C121)	A2C1283160085	11

CITROËN - C5 III (RD_) 02/08→**Common Rail Diesel Injector**

1.6 HDi 110	82 kW	07/10→	9HR (DV6C); 12/11	A2C59513556	18
			9HR (DV6C); 12/11	A2C59513556	18
1.6 HDi 115	84 kW	01/12→	9HR (DV6C)	A2C59513556	18
2.7 HDi	150 kW	02/08→	DT17ED4	A2C59511316	13

**Diesel Common Rail Pump**

1.6 HDi 110	82 kW	07/10→	9HR (DV6C)	A2C59513830	19
1.6 HDi 115	84 kW	01/12→			
2.7 HDi	150 kW	02/08→	DT17ED4; Service exchange part (C121)	A2C1283180085	11
			DT17ED4	A2C59511314	13

CITROËN - C5 III Break (RW_) 02/08→**Common Rail Diesel Injector**

1.6 HDi 110	82 kW	07/10→	9HR (DV6C); 12/11	A2C59513556	18
			9HR (DV6C); 12/11	A2C59513556	18
1.6 HDi 115	84 kW	01/12→	9HR (DV6C)	A2C59513556	18
2.7 HDi	150 kW	02/08→	UHZ (DT17BTED4)	A2C59511316	13
			DT17ED4	A2C59511316	13

**Diesel Common Rail Pump**

1.6 HDi 110	82 kW	07/10→	9HR (DV6C)	A2C59513830	19
1.6 HDi 115	84 kW	01/12→			
2.7 HDi	150 kW	02/08→	UHZ (DT17BTED4); Service exchange part (C121)	A2C1283180085	11
			DT17ED4; Service exchange part (C121)	A2C1283180085	11
			DT17ED4	A2C59511314	13
			UHZ (DT17BTED4)	A2C59511314	13

CITROËN - C6 (TD_) 09/05→12/12**Common Rail Diesel Injector**

2.7 HDi	150 kW	09/05→12/11	UHZ (DT17BTED4)	A2C59511316	13
			DT17ED4	A2C59511316	13

**Diesel Common Rail Pump**

2.7 HDi	150 kW	09/05→12/11	UHZ (DT17BTED4); Service exchange part (C121)	A2C1283180085	11
			DT17ED4; Service exchange part (C121)	A2C1283180085	11
			DT17ED4	A2C59511314	13
			UHZ (DT17BTED4)	A2C59511314	13

CITROËN - C8 (EA_, EB_) 06/02→**Common Rail Diesel Injector**

2.0 HDi	88 kW	07/06→		A2C59511602	14
---------	-------	--------	--	--------------------	----

**Diesel Common Rail Pump**

2.0 HDi	88 kW	07/06→		5WS40809-Z	10
			Service exchange part (C121)	A2C1283160085	11



VDO

CITROËN - DS3 11/09→07/15

Common Rail Diesel Injector

1.6 HDi 110	82 kW	11/09→07/15	9HR (DV6C); 12/11	A2C59513556	18
			9HR (DV6C); 12/11	A2C59513556	18
			9HR (DV6C); 03/10 12/11	A2C59513556	18
			9HR (DV6C); 03/10	A2C59513556	18
1.6 HDi 115	84 kW	08/12→07/15	9HL (DV6C)	A2C59513556	18

Diesel Common Rail Pump

1.6 HDi 110	82 kW	11/09→07/15	9HR (DV6C); 07/10	A2C59513830	19
			9HR (DV6C); 06/10	A2C59513830	19
1.6 HDi 115	84 kW	08/12→07/15	9HL (DV6C)	A2C59513830	19

CITROËN - DS4 03/11→07/15

Common Rail Diesel Injector

1.6 HDi 110	82 kW	04/11→07/15	9HR (DV6C); 12/11	A2C59513556	18
			9HR (DV6C); 12/11	A2C59513556	18
1.6 HDi 115	84 kW	08/12→07/15	9HL (DV6C)	A2C59513556	18

Diesel Common Rail Pump

1.6 HDi 110	82 kW	04/11→07/15	9HR (DV6C)	A2C59513830	19
1.6 HDi 115	84 kW	08/12→07/15	9HL (DV6C)	A2C59513830	19

CITROËN - DS5 09/11→07/15

Common Rail Diesel Injector

1.6 HDi 110	82 kW	11/11→07/15	9HR (DV6C); 12/11	A2C59513556	18
			9HR (DV6C); 12/11	A2C59513556	18
1.6 HDi 115	84 kW	06/12→07/15		A2C59513556	18

Diesel Common Rail Pump

1.6 HDi 110	82 kW	11/11→07/15	9HR (DV6C)	A2C59513830	19
1.6 HDi 115	84 kW	06/12→07/15		A2C59513830	19

CITROËN - JUMPER Box 04/06→

Common Rail Diesel Injector

2.0 BlueHDi 110	81 kW	04/16→	AHM (DW10FUE)	A2C59517051	21
2.0 BlueHDi 130	96 kW	04/16→	AHN (DW10FUD)	A2C59517051	21
2.2 HDi 110	81 kW	07/11→		A2C59517051	21
2.2 HDi 130	96 kW	07/11→			
2.2 HDi 150	110 kW	07/11→			

Diesel Common Rail Pump

2.2 HDi 110	81 kW	07/11→		A2C59517045	20
2.2 HDi 130	96 kW	07/11→			
2.2 HDi 150	110 kW	07/11→			

CITROËN - JUMPER Bus 04/06→

Common Rail Diesel Injector

2.0 BlueHDi 110	81 kW	07/15→		A2C59517051	21
2.2 HDi 110	81 kW	07/11→			
2.2 HDi 130	96 kW	07/11→			
2.2 HDi 150	110 kW	07/11→			

Diesel Common Rail Pump

2.2 HDi 110	81 kW	07/11→		A2C59517045	20
2.2 HDi 130	96 kW	07/11→			
2.2 HDi 150	110 kW	07/11→			

CITROËN - JUMPER Platform/Chassis 04/06→

Common Rail Diesel Injector

2.0 BlueHDi 110	81 kW	04/16→	AHM (DW10FUE)	A2C59517051	21
-----------------	-------	--------	---------------	--------------------	----



					VDO	
CITROËN - JUMPER Platform/Chassis 04/06→						
Common Rail Diesel Injector						
2.0 BlueHDi 130	96 kW	04/16→		AHN (DW10FUD)	A2C59517051	21
2.0 BlueHDi 130 4x4	96 kW	04/16→				
2.2 HDi 110	81 kW	07/11→			A2C59517051	21
2.2 HDi 130	96 kW	07/11→				
2.2 HDi 150	110 kW	07/11→				
Diesel Common Rail Pump						
2.2 HDi 110	81 kW	07/11→			A2C59517045	20
2.2 HDi 130	96 kW	07/11→				
2.2 HDi 150	110 kW	07/11→				
CITROËN - JUMPY (VF7) 01/07→						
Common Rail Diesel Injector						
2.0 HDi 120	88 kW	01/07→			A2C59511602	14
Diesel Common Rail Pump						
2.0 HDi 120	88 kW	01/07→			5WS40809-Z	10
				Service exchange part (C121)	A2C1283160085	11
CITROËN - JUMPY Box 01/07→						
Common Rail Diesel Injector						
2.0 HDi 120	88 kW	01/07→			A2C59511602	14
Diesel Common Rail Pump						
2.0 HDi 120	88 kW	01/07→			5WS40809-Z	10
				Service exchange part (C121)	A2C1283160085	11
CITROËN - XSARA (N1) 04/97→12/05						
Common Rail Diesel Injector						
2.0 HDi 90	66 kW	02/99→03/05		RHY (DW10TD)	5WS40000-Z	8
Diesel Common Rail Pump						
2.0 HDi 90	66 kW	02/99→03/05		RHY (DW10TD)	5WS40018-Z	8
CITROËN - XSARA Break (N2) 10/97→03/10						
Common Rail Diesel Injector						
2.0 HDi 90	66 kW	02/99→08/05		RHY (DW10TD)	5WS40000-Z	8
Diesel Common Rail Pump						
2.0 HDi 90	66 kW	02/99→08/05		RHY (DW10TD)	5WS40018-Z	8
CITROËN - XSARA Coupe (N0) 01/98→04/05						
Common Rail Diesel Injector						
2.0 HDi 90	66 kW	02/99→03/05		RHY (DW10TD)	5WS40000-Z	8
Diesel Common Rail Pump						
2.0 HDi 90	66 kW	02/99→03/05		RHY (DW10TD)	5WS40018-Z	8
DACIA - DUSTER 04/10→						
Common Rail Diesel Injector						
1.5 dCi	79 kW	06/10→		K9K 896	A2C59513484	17
1.5 dCi	80 kW	08/13→		K9K 856	A2C59513484	17
1.5 dCi 4x4	80 kW	08/13→		K9K 858	A2C59513484	17
1.5 dCi 4x4	81 kW	10/10→		K9K 898	A2C59513484	17
Diesel Common Rail Pump						
1.5 dCi	79 kW	06/10→		K9K 896	A2C59513595	18
1.5 dCi	80 kW	08/13→		K9K 856	A2C59513595	18
1.5 dCi 4x4	80 kW	08/13→		K9K 858	A2C59513595	18



VDO



DACIA - DUSTER 04/10→



Diesel Common Rail Pump

1.5 dCi 4x4	81 kW	10/10→	K9K 898	A2C59513595	18
-------------	-------	--------	---------	-------------	----

DACIA - DUSTER Box 04/11→



Common Rail Diesel Injector

1.5 dCi	80 kW	04/13→	K9K 856	A2C59513484	17
1.5 dCi 4x4	80 kW	04/13→	K9K 858	A2C59513484	17



Diesel Common Rail Pump

1.5 dCi	80 kW	04/13→	K9K 856	A2C59513595	18
1.5 dCi 4x4	80 kW	04/13→	K9K 858	A2C59513595	18

DACIA - LODGY (JS_) 03/12→



Common Rail Diesel Injector

1.5 dCi	79 kW	01/13→	K9K 846	A2C59513484	17
---------	-------	--------	---------	-------------	----



Diesel Common Rail Pump

1.5 dCi	79 kW	01/13→	K9K 846	A2C59513595	18
---------	-------	--------	---------	-------------	----

FIAT - SCUDO (270_, 272_) 01/07→



Common Rail Diesel Injector

2.0 D Multijet	88 kW	01/07→	RHK; Version (C2): Class 4	5WS40156-4Z	9
			RHK	A2C59511602	14
2.0 D Multijet	100 kW	01/07→	RHR; Version (C2): Class 4	5WS40156-4Z	9
			RHR; Version (C2): Class 5	5WS40156-Z	10
			RHR; Version (C2): Class 6	A2C59511601	14
2.0 D Multijet 4x4	88 kW	01/07→	RHK; Version (C2): Class 4	5WS40156-4Z	9
			RHK	A2C59511602	14



Diesel Common Rail Pump

2.0 D Multijet	88 kW	01/07→	RHK	5WS40809-Z	10
			RHK; Service exchange part (C121)	A2C1283160085	11
2.0 D Multijet	100 kW	01/07→	RHR	5WS40809-Z	10
			RHR; Service exchange part (C121)	A2C1283160085	11
2.0 D Multijet 4x4	88 kW	01/07→	RHK	5WS40809-Z	10
			RHK; Service exchange part (C121)	A2C1283160085	11

FIAT - SCUDO Box (270_, 272_) 01/07→



Common Rail Diesel Injector

2.0 D Multijet	88 kW	01/07→	RHK; Version (C2): Class 4	5WS40156-4Z	9
			RHK	A2C59511602	14
2.0 D Multijet	100 kW	01/07→	RHR; Version (C2): Class 4	5WS40156-4Z	9
			RHR; Version (C2): Class 5	5WS40156-Z	10
			RHR; Version (C2): Class 6	A2C59511601	14
2.0 D Multijet 4x4	88 kW	01/07→	RHK; Version (C2): Class 4	5WS40156-4Z	9
			RHK	A2C59511602	14



Diesel Common Rail Pump

2.0 D Multijet	88 kW	01/07→	RHK	5WS40809-Z	10
			RHK; Service exchange part (C121)	A2C1283160085	11
2.0 D Multijet	100 kW	01/07→	RHR	5WS40809-Z	10
			RHR; Service exchange part (C121)	A2C1283160085	11
2.0 D Multijet 4x4	88 kW	01/07→	RHK	5WS40809-Z	10
			RHK; Service exchange part (C121)	A2C1283160085	11

FIAT - SCUDO Platform/Chassis (270_, 272_) 01/07→



Common Rail Diesel Injector

2.0 D Multijet	88 kW	01/07→	RHK; Version (C2): Class 4	5WS40156-4Z	9
			RHK	A2C59511602	14



VDO

**FIAT - SCUDO Platform/Chassis (270_, 272_) 01/07→****Common Rail Diesel Injector**

2.0 D Multijet	100 kW	01/07→	RHR / DW10BTED4; Version (C2): Class 4	5WS40156-4Z	9
			RHR	5WS40156-Z	10
			DW10BTED4	5WS40156-Z	10
			RHR / DW10BTED4; Version (C2): Class 6	A2C59511601	14

**Diesel Common Rail Pump**

2.0 D Multijet	88 kW	01/07→	RHK	5WS40809-Z	10
			RHK; Service exchange part (C121)	A2C1283160085	11
2.0 D Multijet	100 kW	01/07→	RHR	5WS40809-Z	10
			DW10BTED4	5WS40809-Z	10
			RHR; Service exchange part (C121)	A2C1283160085	11
			DW10BTED4; Service exchange part (C121)	A2C1283160085	11

FIAT - ULYSSE (179_) 08/02→06/11**Common Rail Diesel Injector**

2.0 D Multijet	88 kW	05/06→06/11	RHK; Version (C2): Class 4	5WS40156-4Z	9
			RHK	A2C59511602	14
2.0 D Multijet	100 kW	05/06→06/11	RHR; Version (C2): Class 4	5WS40156-4Z	9
			RHR; Version (C2): Class 5	5WS40156-Z	10
			RHR; Version (C2): Class 6	A2C59511601	14

**Diesel Common Rail Pump**

2.0 D Multijet	88 kW	05/06→06/11	RHK	5WS40809-Z	10
			RHK; Service exchange part (C121)	A2C1283160085	11
2.0 D Multijet	100 kW	05/06→06/11	RHR	5WS40809-Z	10
			RHR; Service exchange part (C121)	A2C1283160085	11

FORD - C-MAX (DM2) 02/07→09/10**Common Rail Diesel Injector**

1.8 TDCi	85 kW	02/07→09/10	KKDA	A2C59511610	16
2.0 TDCi	100 kW	02/07→09/10	G6DA / G6DB / G6DD / G6DG; Version (C2): Class 4	5WS40156-4Z	9
			G6DA / G6DB / G6DD / G6DG; Version (C2): Class 5	5WS40156-Z	10
			G6DA / G6DB / G6DD / G6DG; Version (C2): Class 6	A2C59511601	14

**Diesel Common Rail Pump**

1.8 TDCi	85 kW	02/07→09/10	KKDA	A2C59511609	16
2.0 TDCi	100 kW	02/07→09/10	G6DB	A2C59511600	14
			G6DD	A2C59511600	14
			G6DG	A2C59511600	14
			G6DA	A2C59511600	14

FORD - C-MAX II (DXA/CB7, DXA/CEU) 04/10→**Common Rail Diesel Injector**

1.6 TDCi	70 kW	12/10→	T3DB	A2C59513556	18
			T3DA	A2C59513556	18
1.6 TDCi	85 kW	12/10→	T1DB	A2C59513556	18
			T1DA	A2C59513556	18

**Diesel Common Rail Pump**

1.6 TDCi	70 kW	12/10→	T3DA	A2C59513829	19
			T3DB	A2C59513829	19
1.6 TDCi	85 kW	12/10→	T1DA	A2C59513829	19
			T1DB	A2C59513829	19

FORD - FIESTA V (JH_, JD_) 11/01→03/10**Common Rail Diesel Injector**

1.4 TDCi	50 kW	11/01→06/08	F6JA	A2C59511612	16
----------	-------	-------------	------	--------------------	----



FORD - FIESTA V (JH_, JD_) 11/01→03/10					
Diesel Common Rail Pump					
1.4 TDCi	50 kW	11/01→06/08	F6JA	5WS40008-Z	8
FORD - FIESTA V Van 05/02→08/08					
Common Rail Diesel Injector					
1.4 TDCi	50 kW	10/03→12/10	F6JB	A2C59511612	16
Diesel Common Rail Pump					
1.4 TDCi	50 kW	10/03→12/10	F6JB	5WS40008-Z	8
FORD - FIESTA VI (CB1, CCN) 06/08→					
Common Rail Diesel Injector					
1.4 TDCi	50 kW	01/09→	F6JB	A2C59511612	16
Diesel Common Rail Pump					
1.4 TDCi	50 kW	01/09→	F6JB	5WS40008-Z	8
1.4 TDCi	51 kW	07/10→	KVJA	5WS40008-Z	8
FORD - FIESTA VI Van 08/08→					
Common Rail Diesel Injector					
1.4 TDCi	50 kW	01/09→	F6JB	A2C59511612	16
Diesel Common Rail Pump					
1.4 TDCi	50 kW	01/09→	F6JB	5WS40008-Z	8
1.4 TDCi	51 kW	07/10→	F6JD	5WS40008-Z	8
FORD - FOCUS (DAW, DBW) 09/98→12/07					
Common Rail Diesel Injector					
1.8 TDCi	74 kW	08/02→11/04	FFDA	A2C59511610	16
Diesel Common Rail Pump					
1.8 TDCi	74 kW	08/02→11/04	FFDA	A2C59511609	16
FORD - FOCUS II (DA_, HCP, DP) 07/04→09/13					
Common Rail Diesel Injector					
1.8 TDCi	85 kW	01/05→09/12	KKDB	A2C59511610	16
			KKDA	A2C59511610	16
2.0 TDCi	100 kW	07/04→09/12	G6DA / G6DB; Version (C2): Class 4	5WS40156-4Z	9
			G6DA / G6DB; Version (C2): Class 5	5WS40156-Z	10
			G6DA / G6DB; Version (C2): Class 6	A2C59511601	14
Diesel Common Rail Pump					
1.8 TDCi	85 kW	01/05→09/12	KKDB	A2C59511609	16
			KKDA	A2C59511609	16
2.0 TDCi	100 kW	07/04→09/12	G6DB; 10/06	5WS40809-Z	10
			G6DA; 10/06	5WS40809-Z	10
			G6DA; 10/06; Service exchange part (C121)	A2C1283160085	11
			G6DB; 10/06; Service exchange part (C121)	A2C1283160085	11
			G6DB; 11/06 ; Specification (C3): Eurocode 223	A2C59511600	14
G6DA; 11/06 ; Specification (C3): Eurocode 223	A2C59511600	14			
FORD - FOCUS II Convertible 10/06→09/10					
Common Rail Diesel Injector					
2.0 TDCi	100 kW	10/06→09/10	G6DA; Version (C2): Class 4	5WS40156-4Z	9
			G6DA; Version (C2): Class 5	5WS40156-Z	10
			G6DA; Version (C2): Class 6	A2C59511601	14



VDO

**FORD - FOCUS II Convertible 10/06→09/10**

Diesel Common Rail Pump					
2.0 TDCi	100 kW	10/06→09/10	G6DA	5WS40809-Z	10
			G6DA; Service exchange part (C121)	A2C1283160085	11
			G6DA; Specification (C3): Eurocode 223	A2C59511600	14

FORD - FOCUS II Saloon (DB_, FCH, DH) 04/05→

Common Rail Diesel Injector					
1.8 TDCi	85 kW	04/05→09/12	KKDB	A2C59511610	16
			KKDA	A2C59511610	16
2.0 TDCi	100 kW	04/05→09/12	G6DB; Version (C2): Class 4	5WS40156-4Z	9
			G6DB; Version (C2): Class 5	5WS40156-Z	10
			G6DB; Version (C2): Class 6	A2C59511601	14

Diesel Common Rail Pump					
1.8 TDCi	85 kW	04/05→09/12	KKDB	A2C59511609	16
			KKDA	A2C59511609	16
2.0 TDCi	100 kW	04/05→09/12	G6DB; 10/06	5WS40809-Z	10
			G6DB; 10/06; Service exchange part (C121)	A2C1283160085	11
			G6DB; 11/06 ; Specification (C3): Eurocode 223	A2C59511600	14

FORD - FOCUS II Turnier (DA_, FFS, DS) 07/04→09/12

Common Rail Diesel Injector					
1.8 TDCi	85 kW	07/04→09/12	KKDB	A2C59511610	16
			KKDA	A2C59511610	16
2.0 TDCi	100 kW	07/04→09/12	G6DA / G6DB; Version (C2): Class 4	5WS40156-4Z	9
			G6DA / G6DB; Version (C2): Class 5	5WS40156-Z	10
			G6DA	A2C59511601	14

Diesel Common Rail Pump					
1.8 TDCi	85 kW	07/04→09/12	KKDB	A2C59511609	16
			KKDA	A2C59511609	16
2.0 TDCi	100 kW	07/04→09/12	G6DB; 10/06	5WS40809-Z	10
			G6DA; 10/06	5WS40809-Z	10
			G6DA; 10/06; Service exchange part (C121)	A2C1283160085	11
			G6DB; 10/06; Service exchange part (C121)	A2C1283160085	11
			G6DB; 11/06 ; Specification (C3): Eurocode 223	A2C59511600	14
			G6DA; 11/06 ; Specification (C3): Eurocode 223	A2C59511600	14

FORD - FOCUS III 07/10→

Common Rail Diesel Injector					
1.6 TDCi	70 kW	07/10→	T3DB	A2C59513556	18
			T3DA	A2C59513556	18
1.6 TDCi	85 kW	07/10→	T1DB	A2C59513556	18
			T1DA	A2C59513556	18
1.6 TDCi ECONetic	77 kW	05/12→	NGDA	A2C59513556	18

Diesel Common Rail Pump					
1.6 TDCi	70 kW	07/10→	T3DA	A2C59513829	19
			T3DB	A2C59513829	19
1.6 TDCi	85 kW	07/10→	T1DA	A2C59513829	19
			T1DB	A2C59513829	19
1.6 TDCi ECONetic	77 kW	05/12→	NGDA	A2C59513829	19

FORD - FOCUS III Saloon 07/10→

Common Rail Diesel Injector					
1.6 TDCi	70 kW	07/10→	T3DB	A2C59513556	18
			T3DA	A2C59513556	18
1.6 TDCi	85 kW	07/10→	T1DB	A2C59513556	18
			T1DA	A2C59513556	18



VDO

FORD - FOCUS III Saloon 07/10→

Diesel Common Rail Pump					
1.6 TDCi	70 kW	07/10→	T3DA	A2C59513829	19
			T3DB	A2C59513829	19
1.6 TDCi	85 kW	07/10→	T1DA	A2C59513829	19
			T1DB	A2C59513829	19

FORD - FOCUS III Turnier 07/10→

Common Rail Diesel Injector					
1.6 TDCi	70 kW	07/10→	T3DB	A2C59513556	18
			T3DA	A2C59513556	18
1.6 TDCi	85 kW	07/10→	T1DB	A2C59513556	18
			T1DA	A2C59513556	18
1.6 TDCi EConetic	77 kW	05/12→	NGDA	A2C59513556	18

Diesel Common Rail Pump					
1.6 TDCi	70 kW	07/10→	T3DA	A2C59513829	19
			T3DB	A2C59513829	19
1.6 TDCi	85 kW	07/10→	T1DA	A2C59513829	19
			T1DB	A2C59513829	19
1.6 TDCi EConetic	77 kW	05/12→	NGDA	A2C59513829	19

FORD - FOCUS C-MAX (DM2) 10/03→03/07

Common Rail Diesel Injector					
1.8 TDCi	85 kW	01/05→03/07	KKDA	A2C59511610	16
2.0 TDCi	100 kW	10/03→03/07	G6DA / G6DB / G6DD / G6DG; Version (C2): Class 4	5WS40156-4Z	9
			G6DA / G6DB / G6DD / G6DG; Version (C2): Class 5	5WS40156-Z	10
			G6DA / G6DB / G6DD / G6DG; Version (C2): Class 6	A2C59511601	14

Diesel Common Rail Pump					
1.8 TDCi	85 kW	01/05→03/07	KKDA	A2C59511609	16
2.0 TDCi	100 kW	10/03→03/07	G6DD; 10/06	5WS40809-Z	10
			G6DG; 10/06	5WS40809-Z	10
			G6DA; 10/06	5WS40809-Z	10
			G6DB; 10/06	5WS40809-Z	10
			G6DD; 10/06; Service exchange part (C121)	A2C1283160085	11
			G6DG; 10/06; Service exchange part (C121)	A2C1283160085	11
			G6DB; 10/06; Service exchange part (C121)	A2C1283160085	11
			G6DA; 10/06; Service exchange part (C121)	A2C1283160085	11
			G6DD; 11/06 ; Specification (C3): Eurocode 223	A2C59511600	14
			G6DG; 11/06 ; Specification (C3): Eurocode 223	A2C59511600	14
			G6DA; 11/06 ; Specification (C3): Eurocode 223	A2C59511600	14
			G6DB; 11/06 ; Specification (C3): Eurocode 223	A2C59511600	14

FORD - FOCUS Saloon (DFW) 02/99→12/07

Common Rail Diesel Injector					
1.8 TDCi	74 kW	08/02→11/04	FFDA	A2C59511610	16

Diesel Common Rail Pump					
1.8 TDCi	74 kW	08/02→11/04	FFDA	A2C59511609	16

FORD - FOCUS Turnier (DNW) 02/99→12/07

Common Rail Diesel Injector					
1.8 TDCi	74 kW	08/02→11/04	FFDA	A2C59511610	16

Diesel Common Rail Pump					
1.8 TDCi	74 kW	08/02→11/04	FFDA	A2C59511609	16



VDO

**FORD - FUSION (JU_) 08/02→12/12****Common Rail Diesel Injector**

1.4 TDCi	50 kW	08/02→12/12	F6JA	5WS40148-Z	9
			F6JB	A2C59511612	16

**Diesel Common Rail Pump**

1.4 TDCi	50 kW	08/02→12/12	F6JA	5WS40008-Z	8
			F6JB	5WS40008-Z	8

FORD - GALAXY (WM) 05/06→06/15**Common Rail Diesel Injector**

1.6 TDCi	85 kW	02/11→06/15		A2C59513556	18
1.8 TDCi	74 kW	05/06→06/15	FFWA	A2C59511610	16
1.8 TDCi	92 kW	05/06→06/15	QYWA	A2C59511610	16
2.0 TDCi	100 kW	05/06→06/15	UKWA / AZWC	5WS40156-4Z	9
			AZWC / UKWA; Version (C2): Class 5	5WS40156-Z	10
			AZWC / UKWA; Version (C2): Class 6	A2C59511601	14
2.0 TDCi	103 kW	05/06→06/15	QXWA / QXWB / QXWC / UFWA; Version (C2): Class 4	5WS40156-4Z	9
			QXWA / QXWB / QXWC / UFWA; Version (C2): Class 5	5WS40156-Z	10
			QXWA / QXWB / QXWC / UFWA; Version (C2): Class 6	A2C59511601	14

**Diesel Common Rail Pump**

1.6 TDCi	85 kW	02/11→06/15		A2C59513829	19
1.8 TDCi	74 kW	05/06→06/15	FFWA	A2C59511609	16
1.8 TDCi	92 kW	05/06→06/15	QYWA	A2C59511609	16
2.0 TDCi	100 kW	05/06→06/15	UKWA	A2C59511600	14
			AZWC	A2C59511600	14
2.0 TDCi	103 kW	05/06→06/15	QXWB	A2C59511600	14
			QXWA	A2C59511600	14
			UFWA	A2C59511600	14
			QXWC	A2C59511600	14

FORD - GRAND C-MAX (DXA/CB7, DXA/CEU) 12/10→**Common Rail Diesel Injector**

1.6 TDCi	70 kW	12/10→	T3DB	A2C59513556	18
			T3DA	A2C59513556	18
1.6 TDCi	85 kW	12/10→	T1DB	A2C59513556	18
			T1DA	A2C59513556	18

**Diesel Common Rail Pump**

1.6 TDCi	70 kW	12/10→	T3DA	A2C59513829	19
			T3DB	A2C59513829	19
1.6 TDCi	85 kW	12/10→	T1DA	A2C59513829	19
			T1DB	A2C59513829	19

FORD - KUGA I 02/08→11/12**Common Rail Diesel Injector**

2.0 TDCi	100 kW	03/08→11/12	UKDA / G6DG; Version (C2): Class 4	5WS40156-4Z	9
			UKDA / G6DG; Version (C2): Class 5	5WS40156-Z	10
			UKDA / G6DG; Version (C2): Class 6	A2C59511601	14
2.0 TDCi	103 kW	03/10→11/12	UFDA; Version (C2): Class 4	5WS40156-4Z	9
			UFDA; Version (C2): Class 5	5WS40156-Z	10
			UFDA; Version (C2): Class 6	A2C59511601	14
2.0 TDCi 4x4	100 kW	03/08→11/12	G6DG / UKDA; Version (C2): Class 4	5WS40156-4Z	9
			G6DG / UKDA; Version (C2): Class 5	5WS40156-Z	10
			G6DG / UKDA; Version (C2): Class 6	A2C59511601	14
2.0 TDCi 4x4	103 kW	03/10→11/12	UFDA; Version (C2): Class 4	5WS40156-4Z	9
			UFDA; Version (C2): Class 5	5WS40156-Z	10
			UFDA; Version (C2): Class 6	A2C59511601	14



VDO

FORD - KUGA I 02/08→11/12

Diesel Common Rail Pump

2.0 TDCi	100 kW	03/08→11/12	UKDA	A2C59511600	14
			G6DG	A2C59511600	14
2.0 TDCi	103 kW	03/10→11/12	UFDA	A2C59511600	14
2.0 TDCi 4x4	100 kW	03/08→11/12	UKDA	A2C59511600	14
			G6DG	A2C59511600	14
2.0 TDCi 4x4	103 kW	03/10→11/12	UFDA	A2C59511600	14

FORD - MONDEO IV (BA7) 03/07→01/15

Common Rail Diesel Injector

1.6 TDCi	85 kW	02/11→01/15	T1BB	A2C59513556	18
1.8 TDCi	74 kW	03/07→01/15	FFBA	A2C59511610	16
1.8 TDCi	92 kW	06/07→01/15	QYBA	A2C59511610	16
			KHBA	A2C59511610	16
2.0 TDCi	100 kW	03/07→12/14	UKBA / AZBC	5WS40156-4Z	9
			AZBC / UKBA; Version (C2): Class 5	5WS40156-Z	10
			AZBC / UKBA; Version (C2): Class 6	A2C59511601	14
2.0 TDCi	103 kW	03/07→01/15	QXBA / QXBB / UFBA; Version (C2): Class 4	5WS40156-4Z	9
			QXBA / QXBB / UFBA; Version (C2): Class 5	5WS40156-Z	10
			QXBA / QXBB / UFBA; Version (C2): Class 6	A2C59511601	14

Diesel Common Rail Pump

1.6 TDCi	85 kW	02/11→01/15	T1BB	A2C59513829	19
1.8 TDCi	74 kW	03/07→01/15	FFBA	A2C59511609	16
1.8 TDCi	92 kW	06/07→01/15	KHBA	A2C59511609	16
			QYBA	A2C59511609	16
2.0 TDCi	100 kW	03/07→12/14	UKBA	A2C59511600	14
			AZBC	A2C59511600	14
2.0 TDCi	103 kW	03/07→01/15	QXBA	A2C59511600	14
			QXBB	A2C59511600	14
			UFBA	A2C59511600	14

FORD - MONDEO IV Saloon (BA7) 03/07→01/15

Common Rail Diesel Injector

1.8 TDCi	74 kW	03/07→01/15	FFBA	A2C59511610	16
1.8 TDCi	92 kW	06/07→01/15	KHBA	A2C59511610	16
			QYBA	A2C59511610	16
2.0 TDCi	103 kW	03/07→01/15	UFBA / QXBA / QXBB	5WS40156-4Z	9
			QXBA / QXBB / UFBA; Version (C2): Class 5	5WS40156-Z	10
			QXBA / QXBB / UFBA; Version (C2): Class 6	A2C59511601	14

Diesel Common Rail Pump

1.8 TDCi	74 kW	03/07→01/15	FFBA	A2C59511609	16
1.8 TDCi	92 kW	06/07→01/15	KHBA	A2C59511609	16
			QYBA	A2C59511609	16
2.0 TDCi	103 kW	03/07→01/15	QXBA	A2C59511600	14
			QXBB	A2C59511600	14
			UFBA	A2C59511600	14

FORD - MONDEO IV Turnier (BA7) 03/07→01/15

Common Rail Diesel Injector

1.6 TDCi	85 kW	02/11→01/15	T1BB	A2C59513556	18
1.8 TDCi	74 kW	03/07→12/12	FFBA	A2C59511610	16
1.8 TDCi	92 kW	06/07→12/12	QYBA	A2C59511610	16
			KHBA	A2C59511610	16
2.0 TDCi	100 kW	03/07→12/14	UKBA / AZBC; Version (C2): Class 4	5WS40156-4Z	9
			UKBA / AZBC; Version (C2): Class 5	5WS40156-Z	10
			UKBA / AZBC; Version (C2): Class 6	A2C59511601	14



VDO

**FORD - MONDEO IV Turnier (BA7) 03/07→01/15****Common Rail Diesel Injector**

2.0 TDCi	103 kW	03/07→01/15	QXBA / QXBB / UFBA; Version (C2): Class 4	5WS40156-4Z	9
			QXBA / QXBB / UFBA; Version (C2): Class 5	5WS40156-Z	10
			QXBA / QXBB / UFBA; Version (C2): Class 6	A2C59511601	14

**Diesel Common Rail Pump**

1.6 TDCi	85 kW	02/11→01/15	T1BB	A2C59513829	19
1.8 TDCi	74 kW	03/07→12/12	FFBA	A2C59511609	16
1.8 TDCi	92 kW	06/07→12/12	KHBA	A2C59511609	16
			QYBA	A2C59511609	16
2.0 TDCi	100 kW	03/07→12/14	UKBA	A2C59511600	14
			AZBC	A2C59511600	14
2.0 TDCi	103 kW	03/07→01/15	QXBA	A2C59511600	14
			QXBB	A2C59511600	14
			UFBA	A2C59511600	14

FORD - RANGER (TKE) 04/11→**Common Rail Diesel Injector**

2.2 TDCi	88 kW	04/11→	GBVAJPF; Production date to (C29): 14.09.2015	A2C59517051	21
			GBVAJPF; Production date from (C28): 15.09.2015	A2C8139490080	21
2.2 TDCi	92 kW	04/11→	GBVAJQW; Production date to (C29): 14.09.2015	A2C59517051	21
2.2 TDCi	96 kW	05/15→	Production date to (C29): 14.09.2015	A2C59517051	21
			Production date from (C28): 15.09.2015	A2C8139490080	21
2.2 TDCi	110 kW	11/11→	GBVAJQJ; Production date to (C29): 14.09.2015	A2C59517051	21
			GBVAJQJ; Production date from (C28): 15.09.2015	A2C8139490080	21
2.2 TDCi 4x4	92 kW	04/11→	GBVAJQW; Production date to (C29): 14.09.2015	A2C59517051	21
2.2 TDCi 4x4	96 kW	05/15→	Production date to (C29): 14.09.2015	A2C59517051	21
			Production date from (C28): 15.09.2015	A2C8139490080	21
2.2 TDCi 4x4	110 kW	04/11→	GBVAJQJ; Production date to (C29): 14.09.2015	A2C59517051	21
			GBVAJQJ; Production date from (C28): 15.09.2015	A2C8139490080	21
3.2 TDCi 4x4	147 kW	04/11→	SAFA; Production date to (C29): 14.09.2015	A2C59517051	21
			SAFA; Production date from (C28): 15.09.2015	A2C8139490080	21

**Diesel Common Rail Pump**

2.2 TDCi	88 kW	04/11→	GBVAJPF; 09/11	A2C59517043	19
			GBVAJPF; 09/11 - 10/11	A2C59517043	19
2.2 TDCi	92 kW	04/11→	GBVAJQW; 09/11	A2C59517043	19
			GBVAJQW; 09/11 - 10/11	A2C59517043	19
2.2 TDCi	96 kW	05/15→	Production date from (C28): 14.09.2015	A2C9321760080	21
2.2 TDCi	110 kW	11/11→	GBVAJQJ	A2C59517043	19
2.2 TDCi	118 kW	05/15→	Production date from (C28): 14.09.2015	A2C9321760080	21
2.2 TDCi 4x4	92 kW	04/11→	GBVAJQW; 09/11	A2C59517043	19
			GBVAJQW; 09/11 - 10/11	A2C59517043	19
2.2 TDCi 4x4	96 kW	05/15→	Production date from (C28): 14.09.2015	A2C9321760080	21
2.2 TDCi 4x4	110 kW	04/11→	GBVAJQJ; 09/11 - 10/11	A2C59517043	19
			GBVAJQJ; 09/11	A2C59517043	19
2.2 TDCi 4x4	118 kW	05/15→	Production date from (C28): 14.09.2015	A2C9321760080	21
3.2 TDCi 4x4	147 kW	04/11→	SAFA; 09/11 - 10/11	A2C59517043	19
			SAFA; 09/11	A2C59517043	19

Distributor Pipe, fuel

2.2 TDCi	88 kW	04/11→	GBVAJPF	A2C5328876880	12
2.2 TDCi	96 kW	05/15→	GBVAJQJ	A2C5328876880	12
2.2 TDCi	110 kW	11/11→	GBVAJQJ	A2C5328876880	12
2.2 TDCi 4x4	96 kW	05/15→	GBVAJQJ	A2C5328876880	12
2.2 TDCi 4x4	110 kW	04/11→	GBVAJQJ	A2C5328876880	12

FORD - S-MAX (WS) 05/06→12/14**Common Rail Diesel Injector**

1.6 TDCi	85 kW	02/11→12/14		A2C59513556	18
1.8 TDCi	74 kW	01/07→12/10	FFWA	A2C59511610	16



VDO

FORD - S-MAX (WS) 05/06→12/14
Common Rail Diesel Injector

1.8 TDCi	92 kW	05/06→12/14	QYWA	A2C59511610	16
2.0 TDCi	100 kW	05/06→12/14	UKWA / AZWC; Version (C2): Class 4	5WS40156-4Z	9
			UKWA / AZWC; Version (C2): Class 5	5WS40156-Z	10
			AZWC / UKWA	A2C59511601	14
2.0 TDCi	103 kW	05/06→12/14	QXWA / QXWB / QXWC / UFWA; Version (C2): Class 4	5WS40156-4Z	9
			QXWA / QXWB / QXWC / UFWA; Version (C2): Class 5	5WS40156-Z	10
			QXWC / QXWA / QXWB / UFWA	A2C59511601	14

Diesel Common Rail Pump

1.6 TDCi	85 kW	02/11→12/14		A2C59513829	19
1.8 TDCi	74 kW	01/07→12/10	FFWA	A2C59511609	16
1.8 TDCi	92 kW	05/06→12/14	QYWA	A2C59511609	16
2.0 TDCi	100 kW	05/06→12/14	UKWA	A2C59511600	14
			AZWC	A2C59511600	14
2.0 TDCi	103 kW	05/06→12/14	QXWB	A2C59511600	14
			QXWA	A2C59511600	14
			UFWA	A2C59511600	14
			QXWC	A2C59511600	14

FORD - TOURNEO CONNECT 06/02→12/13
Common Rail Diesel Injector

1.8 TDCi	66 kW	06/02→12/13	08/06 ; RWPF / HCPA / HCPB / R3PA / P9PD / P9PA / P9PC / P9PB / RWPE	A2C59511610	16
			08/06 ; RWPF, HCPA, HCPB / R3PA, P9PD, P9PA / P9PC, P9PB, RWPE	A2C59511611	16
1.8 TDCi	81 kW	08/06→12/13	RWPD	A2C59511610	16
			RWPC	A2C59511610	16
			RWPA	A2C59511610	16
1.8 TDCi /TDDi /DI	55 kW	06/02→12/13	08/06 ; P7PA / P7PB / R2PA / BHPA	A2C59511610	16
			08/06 ; P7PA, P7PB / R2PA, BHPA	A2C59511611	16

Diesel Common Rail Pump

1.8 TDCi	66 kW	06/02→12/13	08/06 ; RWPF / HCPA / HCPB / R3PA / P9PD / P9PA / P9PC / P9PB / RWPE	A2C59511609	16
1.8 TDCi	81 kW	08/06→12/13	RWPA	A2C59511609	16
			RWPC	A2C59511609	16
			RWPD	A2C59511609	16
1.8 TDCi /TDDi /DI	55 kW	06/02→12/13	08/06 ; P7PA / P7PB / R2PA / BHPA	A2C59511609	16

FORD - TOURNEO CUSTOM Bus 04/12→
Common Rail Diesel Injector

2.2 TDCi	74 kW	04/12→		A2C59517051	21
2.2 TDCi	92 kW	04/12→			
2.2 TDCi	114 kW	04/12→			

Diesel Common Rail Pump

2.0 TDCi	77 kW	12/15→		A2C1637670080	11
2.0 TDCi	96 kW	12/15→			
2.2 TDCi	74 kW	04/12→		A2C59517045	20
2.2 TDCi	92 kW	04/12→			
2.2 TDCi	114 kW	04/12→			

Distributor Pipe, fuel

2.2 TDCi	74 kW	04/12→	DRF4 / DRFF / DRFG; 12/14	A2C5328876880	12
2.2 TDCi	92 kW	04/12→	CYF4 / CYFF; 12/14	A2C5328876880	12
2.2 TDCi	114 kW	04/12→	CVFF; 12/14	A2C5328876880	12



VDO

**FORD - TRANSIT Box 08/13→****Common Rail Diesel Injector**

2.2 TDCi	74 kW	08/13→	DRFG / DRF5 / DRFF	A2C59517051	21
2.2 TDCi	92 kW	08/13→	USF6 / CYFG / CYF5 / CY14	A2C59517051	21
2.2 TDCi	114 kW	08/13→	CVF5	A2C59517051	21
2.2 TDCi 4x4	92 kW	08/13→	CYR5 / CY24	A2C59517051	21
2.2 TDCi 4x4	114 kW	08/13→	CVR5 / CV24	A2C59517051	21
2.2 TDCi RWD	74 kW	08/13→	DRR5	A2C59517051	21
2.2 TDCi RWD	92 kW	08/13→	USR6	A2C59517051	21
2.2 TDCi RWD	114 kW	08/13→	CV24 / CVR5 / UYR6	A2C59517051	21

**Diesel Common Rail Pump**

2.0 TDCi	77 kW	03/16→		A2C1637670080	11
2.0 TDCi	96 kW	03/16→			
2.0 TDCi 4x4	96 kW	01/17→			
2.0 TDCi RWD	77 kW	03/16→			
2.0 TDCi RWD	96 kW	03/16→			

Distributor Pipe, fuel

2.2 TDCi	74 kW	08/13→	DRF5 / DRFF / DRFG; - 12/14	A2C5328876880	12
2.2 TDCi	92 kW	08/13→	USF6 / CYFG / CYF5 / CY14; - 12/14	A2C5328876880	12
2.2 TDCi	114 kW	08/13→	CVF5; - 12/14	A2C5328876880	12
2.2 TDCi 4x4	92 kW	08/13→	CY24 / CYR5; - 12/14	A2C5328876880	12
2.2 TDCi 4x4	114 kW	08/13→	CV24 / CVR5; - 12/14	A2C5328876880	12
2.2 TDCi RWD	74 kW	08/13→	DRR5; - 12/14	A2C5328876880	12
2.2 TDCi RWD	92 kW	08/13→	USR6; - 12/14	A2C5328876880	12
2.2 TDCi RWD	114 kW	08/13→	CV24 / CVR5 / UYR6; - 12/14	A2C5328876880	12

FORD - TRANSIT Box (FA_) 04/06→**Common Rail Diesel Injector**

2.2 TDCi	74 kW	10/11→08/14	DRFA	A2C59517051	21
			DRFE	A2C59517051	21
			DRFB	A2C59517051	21
			DRFD	A2C59517051	21
			DRFC	A2C59517051	21
2.2 TDCi	92 kW	10/11→08/14	CYFB	A2C59517051	21
			CYFA	A2C59517051	21
			CYFD	A2C59517051	21
			CYFC	A2C59517051	21
2.2 TDCi	103 kW	10/07→08/14	PGFB	A2C59517051	21
			UHFA	A2C59517051	21
2.2 TDCi 4x4	92 kW	10/11→08/14	CYRB	A2C59517051	21
			CYRC	A2C59517051	21
2.2 TDCi RWD	74 kW	10/11→08/14		A2C59517051	21
2.2 TDCi RWD	92 kW	10/11→08/14			
2.2 TDCi RWD	114 kW	10/11→08/14			

**Diesel Common Rail Pump**

2.2 TDCi	74 kW	10/11→08/14	DRFE; - 10/11	A2C59517043	19
			DRFD; - 10/11	A2C59517043	19
			DRFB; - 10/11	A2C59517043	19
			DRFA; - 10/11	A2C59517043	19
			DRFC; - 10/11	A2C59517043	19
2.2 TDCi	92 kW	10/11→08/14	CYFB; - 10/11	A2C59517043	19
			CYFA; - 10/11	A2C59517043	19
			CYFD; - 10/11	A2C59517043	19
			CYFC; - 10/11	A2C59517043	19
			CYFA	A2C59517045	20
2.2 TDCi	103 kW	10/07→08/14	UHFA; - 10/11	A2C59517043	19
			UHFC; - 09/11	A2C59517043	19
			PGFB; - 09/11	A2C59517043	19
			PGFA; - 10/11	A2C59517043	19
			UHFB; - 10/11	A2C59517043	19

→



VDO

FORD - TRANSIT Box (FA_ _) 04/06→

Diesel Common Rail Pump

2.2 TDCi	103 kW	10/07→08/14	UHFC; - 10/11	A2C59517043	19
			PGFB; - 10/11	A2C59517043	19
			UHFB; - 09/11	A2C59517043	19
			UHFB; - 09/11 - 10/11	A2C59517043	19
			PGFA; - 09/11 - 10/11	A2C59517043	19
			PGFB; - 09/11 - 10/11	A2C59517043	19
			UHFA; - 09/11 - 10/11	A2C59517043	19
			UHFA; - 09/11	A2C59517043	19
			PGFA; - 09/11	A2C59517043	19
			UHFC; - 09/11 - 10/11	A2C59517043	19
2.2 TDCi 4x4	92 kW	10/11→08/14	CYRC; - 10/11	A2C59517043	19
			CYRB; - 10/11	A2C59517043	19
			CYRC	A2C59517045	20
2.2 TDCi RWD	74 kW	10/11→08/14		A2C59517043	19
2.2 TDCi RWD	92 kW	10/11→08/14		A2C59517045	20
2.2 TDCi RWD	114 kW	10/11→08/14			

Distributor Pipe, fuel

2.2 TDCi	74 kW	10/11→08/14	DRFA / DRFB / DRFC / DRFD / DRFE	A2C5328876880	12
2.2 TDCi	92 kW	10/11→08/14	CYFA / CYFB / CYFC / CYFD	A2C5328876880	12
2.2 TDCi	103 kW	10/07→08/14	PGFA / PGFB / UHFA / UHFB / UHFC; - 10/11	A2C5328876880	12
2.2 TDCi 4x4	92 kW	10/11→08/14	CYRB / CYRC	A2C5328876880	12
2.2 TDCi RWD	74 kW	10/11→08/14	DRRA / DRRB / DRRC	A2C5328876880	12
2.2 TDCi RWD	92 kW	10/11→08/14	CYRA / CYRB	A2C5328876880	12
2.2 TDCi RWD	100 kW	10/11→08/14	USRA / USRB	A2C5328876880	12
2.2 TDCi RWD	114 kW	10/11→08/14	CVRA / CVRB / CVRC; - 12/14	A2C5328876880	12

FORD - TRANSIT Bus 08/13→

Common Rail Diesel Injector

2.2 TDCi	74 kW	08/13→	DRFF / DRF5 / DRFG	A2C59517051	21
2.2 TDCi	92 kW	08/13→	CY14 / CYF5 / CYFG	A2C59517051	21
2.2 TDCi	114 kW	12/14→	CVF5	A2C59517051	21
2.2 TDCi 4x4	92 kW	08/13→	CY24 / CYR5	A2C59517051	21
2.2 TDCi RWD	74 kW	08/13→	DRR5	A2C59517051	21
2.2 TDCi RWD	92 kW	08/13→	USR6	A2C59517051	21
2.2 TDCi RWD	99 kW	08/13→	UHR5	A2C59517051	21
2.2 TDCi RWD	114 kW	08/13→	CV24 / CVR5 / UYR6	A2C59517051	21

Diesel Common Rail Pump

2.0 TDCi	77 kW	03/16→		A2C1637670080	11
2.0 TDCi	96 kW	03/16→			

Distributor Pipe, fuel

2.2 TDCi	74 kW	08/13→	DRF5 / DRFF / DRFG; - 12/14	A2C5328876880	12
2.2 TDCi	92 kW	08/13→	CY14 / CYF5 / CYFG; - 12/14	A2C5328876880	12
2.2 TDCi 4x4	92 kW	08/13→	CY24 / CYR5; - 12/14	A2C5328876880	12
2.2 TDCi RWD	74 kW	08/13→	DRR5; - 12/14	A2C5328876880	12
2.2 TDCi RWD	92 kW	08/13→	USR6; - 12/14	A2C5328876880	12
2.2 TDCi RWD	99 kW	08/13→	UHR5; - 12/14	A2C5328876880	12
2.2 TDCi RWD	114 kW	08/13→	CV24 / CVR5 / UYR6; - 12/14	A2C5328876880	12

FORD - TRANSIT Bus (FD_ _, FB_ _, FS_ _, FZ_ _, FC_ _) 04/06→

Common Rail Diesel Injector

2.2 TDCi	74 kW	10/11→08/14	DRFB	A2C59517051	21
			DRFC	A2C59517051	21
2.2 TDCi	92 kW	10/11→08/14	CYFB	A2C59517051	21
			CYFA	A2C59517051	21
			CYFD	A2C59517051	21
			CYFC	A2C59517051	21
2.2 TDCi	103 kW	10/07→08/14	PGFA	A2C59517051	21



VDO

**FORD - TRANSIT Bus (FD_, FB_, FS_, FZ_, FC_) 04/06→****Common Rail Diesel Injector**

2.2 TDCi RWD	74 kW	10/11→08/14		A2C59517051	21
2.2 TDCi RWD	92 kW	10/11→08/14			
2.2 TDCi RWD	100 kW	09/11→08/14			

**Diesel Common Rail Pump**

2.2 TDCi	74 kW	10/11→08/14	DRFB; 10/11	A2C59517043	19
			DRFE; 10/11	A2C59517043	19
			DRFD; 10/11	A2C59517043	19
			DRFA; 10/11	A2C59517043	19
			DRFC; 10/11	A2C59517043	19
			DRFB	A2C59517045	20
2.2 TDCi	92 kW	10/11→08/14	CYFB; 10/11	A2C59517043	19
			CYFA; 10/11	A2C59517043	19
			CYFD; 10/11	A2C59517043	19
			CYFC; 10/11	A2C59517043	19
			CYFA	A2C59517045	20
2.2 TDCi	103 kW	10/07→08/14	UHFA; 09/11 10/11	A2C59517043	19
			UHFB; 09/11 10/11	A2C59517043	19
			UHFA; 10/11	A2C59517043	19
			PGFA; 10/11	A2C59517043	19
			UHFB; 10/11	A2C59517043	19
			UHFC; 10/11	A2C59517043	19
			PGFB; 10/11	A2C59517043	19
			PGFB; 09/11	A2C59517043	19
			PGFA; 09/11	A2C59517043	19
			PGFB; 09/11 10/11	A2C59517043	19
			UHFC; 09/11 10/11	A2C59517043	19
			UHFA; 09/11	A2C59517043	19
			UHFC; 09/11	A2C59517043	19
			UHFB; 09/11	A2C59517043	19
			PGFA; 09/11 10/11	A2C59517043	19
			2.2 TDCi RWD	74 kW	10/11→08/14
2.2 TDCi RWD	92 kW	10/11→08/14			
2.2 TDCi RWD	100 kW	09/11→08/14	10/11	A2C59517043	19
				A2C59517045	20

Distributor Pipe, fuel

2.2 TDCi	74 kW	10/11→08/14	DRFA / DRFB / DRFC / DRFD / DRFE	A2C5328876880	12
2.2 TDCi	92 kW	10/11→08/14	CYFA / CYFB / CYFC / CYFD	A2C5328876880	12
2.2 TDCi	103 kW	10/07→08/14	PGFA / PGFB / UHFA / UHFB / UHFC; 10/11	A2C5328876880	12
2.2 TDCi RWD	74 kW	10/11→08/14	DRRR / DRRB / DRRC	A2C5328876880	12
2.2 TDCi RWD	92 kW	10/11→08/14	CYRA / CYRB	A2C5328876880	12
2.2 TDCi RWD	100 kW	09/11→08/14	USRA / USRB	A2C5328876880	12



































FORD - TRANSIT CONNECT (P65_, P70_, P80_) 06/02→**Common Rail Diesel Injector**

1.8 Di	55 kW	06/02→12/13	12/07	A2C59511610	16
			12/07 ; P7PA, P7PB / BHPA, R2PA	A2C59511611	16
1.8 TDCi	66 kW	06/02→12/13	08/06 ;	A2C59511610	16
			P9PD / R3PA / P9PB / P9PC / RWPE / HCPA / HCPB / P9PA / RWPF		
			08/06 ;	A2C59511611	16
1.8 TDCi	81 kW	08/06→12/13	P9PD, R3PA, P9PB / P9PC, RWPE, HCPA / HCPB, P9PA, RWPF		
			RWPD	A2C59511610	16
			RWPC	A2C59511610	16
			RWPA	A2C59511610	16

**Diesel Common Rail Pump**

1.8 Di	55 kW	06/02→12/13	12/07 ; P7PA / BHPA / P7PB / R2PA	A2C59511609	16
--------	-------	-------------	------------------------------------	--------------------	----



     				
FORD - TRANSIT CONNECT (P65_, P70_, P80_) 06/02→				
Diesel Common Rail Pump				
1.8 TDCi	66 kW 06/02→12/13	 08/06 ;  P9PD / R3PA / P9PB / P9PC / RWPE / HCPA / HCPB / P9PA / RWPF	A2C59511609	16
1.8 TDCi	81 kW 08/06→12/13	 RWPA  RWPC  RWPD	A2C59511609	16
			A2C59511609	16
			A2C59511609	16
FORD - TRANSIT CUSTOM Box 04/12→				
Common Rail Diesel Injector				
2.2 TDCi	74 kW 04/12→		A2C59517051	21
2.2 TDCi	92 kW 04/12→			
2.2 TDCi	114 kW 04/12→			
Diesel Common Rail Pump				
2.0 TDCi	77 kW 12/15→		A2C1637670080	11
2.0 TDCi	96 kW 12/15→			
2.2 TDCi	74 kW 04/12→		A2C59517045	20
2.2 TDCi	92 kW 04/12→			
2.2 TDCi	114 kW 04/12→			
Distributor Pipe, fuel				
2.2 TDCi	74 kW 04/12→	 DRF4 / DRFF / DRFG;  12/14	A2C5328876880	12
2.2 TDCi	92 kW 04/12→	 CYF4 / CYFF;  12/14	A2C5328876880	12
2.2 TDCi	114 kW 04/12→	 CVFF;  12/14	A2C5328876880	12
FORD - TRANSIT CUSTOM Bus 04/12→				
Common Rail Diesel Injector				
2.2 TDCi	74 kW 04/12→		A2C59517051	21
2.2 TDCi	92 kW 04/12→			
2.2 TDCi	114 kW 04/12→			
Diesel Common Rail Pump				
2.0 TDCi	77 kW 12/15→		A2C1637670080	11
2.0 TDCi	96 kW 12/15→			
2.2 TDCi	74 kW 04/12→		A2C59517045	20
2.2 TDCi	92 kW 04/12→			
2.2 TDCi	114 kW 04/12→			
Distributor Pipe, fuel				
2.2 TDCi	74 kW 04/12→	 DRF4 / DRFF / DRFG;  12/14	A2C5328876880	12
2.2 TDCi	92 kW 04/12→	 CYF4 / CYFF;  12/14	A2C5328876880	12
2.2 TDCi	114 kW 04/12→	 CVFF;  12/14	A2C5328876880	12
FORD - TRANSIT Platform/Chassis 08/13→				
Common Rail Diesel Injector				
2.2 TDCi	74 kW 08/13→	 DRF5 / DRFG / DRFF	A2C59517051	21
2.2 TDCi	92 kW 08/13→	 CYF5	A2C59517051	21
2.2 TDCi	114 kW 08/13→	 CVF5	A2C59517051	21
2.2 TDCi 4x4	92 kW 08/13→	 CYR5 / CY24	A2C59517051	21
2.2 TDCi 4x4	114 kW 08/13→	 CV24 / CVR5	A2C59517051	21
2.2 TDCi RWD	74 kW 08/13→	 DRR5	A2C59517051	21
2.2 TDCi RWD	92 kW 08/13→	 USR6	A2C59517051	21
2.2 TDCi RWD	99 kW 08/13→	 UHR5	A2C59517051	21
2.2 TDCi RWD	114 kW 08/13→	 CVR5 / UYR6 / CV24	A2C59517051	21
Diesel Common Rail Pump				
2.0 TDCi	77 kW 03/16→		A2C1637670080	11
2.0 TDCi	96 kW 03/16→			
2.0 TDCi 4x4	96 kW 01/17→			
2.0 TDCi RWD	77 kW 03/16→			
2.0 TDCi RWD	96 kW 03/16→			
Distributor Pipe, fuel				
2.2 TDCi	74 kW 08/13→	 DRF5 / DRFF / DRFG;  12/14	A2C5328876880	12



VDO

**FORD - TRANSIT Platform/Chassis 08/13→****Distributor Pipe, fuel**

2.2 TDCi	92 kW	08/13→	CYF5; 12/14	A2C5328876880	12
2.2 TDCi	114 kW	08/13→	CVF5; 12/14	A2C5328876880	12
2.2 TDCi 4x4	92 kW	08/13→	CY24 / CY25; 12/14	A2C5328876880	12
2.2 TDCi 4x4	114 kW	08/13→	CV24 / CVR5; 12/14	A2C5328876880	12
2.2 TDCi RWD	74 kW	08/13→	DRR5; 12/14	A2C5328876880	12
2.2 TDCi RWD	92 kW	08/13→	USR6; 12/14	A2C5328876880	12
2.2 TDCi RWD	99 kW	08/13→	UHR5; 12/14	A2C5328876880	12
2.2 TDCi RWD	114 kW	08/13→	CV24 / CVR5 / UYR6; 12/14	A2C5328876880	12

FORD - TRANSIT Platform/Chassis (FM_ , FN_) 04/06→08/14**Common Rail Diesel Injector**

2.2 TDCi	74 kW	10/11→08/14	DRFA	A2C59517051	21
			DRFE	A2C59517051	21
			DRFB	A2C59517051	21
			DRFD	A2C59517051	21
			DRFC	A2C59517051	21
2.2 TDCi	92 kW	10/11→08/14	CYFB	A2C59517051	21
			CYFA	A2C59517051	21
			CYFD	A2C59517051	21
			CYFC	A2C59517051	21
2.2 TDCi	103 kW	10/07→09/11	PGFB	A2C59517051	21
			UHFC	A2C59517051	21
2.2 TDCi 4x4	92 kW	10/11→08/14	CYRB	A2C59517051	21
2.2 TDCi RWD	74 kW	10/11→08/14		A2C59517051	21
2.2 TDCi RWD	92 kW	10/11→08/14		A2C59517051	21
2.2 TDCi RWD	114 kW	10/11→08/14		A2C59517051	21

**Diesel Common Rail Pump**

2.2 TDCi	74 kW	10/11→08/14	DRFB; 10/11	A2C59517043	19
			DRFE; 10/11	A2C59517043	19
			DRFD; 10/11	A2C59517043	19
			DRFA; 10/11	A2C59517043	19
			DRFC; 10/11	A2C59517043	19
			DRFE	A2C59517045	20
2.2 TDCi	92 kW	10/11→08/14	CYFB; 10/11	A2C59517043	19
			CYFA; 10/11	A2C59517043	19
			CYFD; 10/11	A2C59517043	19
			CYFC; 10/11	A2C59517043	19
			CYFA	A2C59517045	20
			CYFB	A2C59517045	20
			CYFD	A2C59517045	20
2.2 TDCi	103 kW	10/07→09/11	UHFC; 09/11	A2C59517043	19
			PGFB; 09/11	A2C59517043	19
			UHFB; 09/11	A2C59517043	19
			PGFA; 09/11	A2C59517043	19
			UHFA; 09/11	A2C59517043	19
2.2 TDCi 4x4	92 kW	10/11→08/14	CYRC; 10/11	A2C59517043	19
			CYRB; 10/11	A2C59517043	19
			CYRB	A2C59517045	20
2.2 TDCi RWD	74 kW	10/11→08/14		A2C59517045	20
2.2 TDCi RWD	92 kW	10/11→08/14		A2C59517045	20
2.2 TDCi RWD	114 kW	10/11→08/14		A2C59517045	20

Distributor Pipe, fuel

2.2 TDCi	74 kW	10/11→08/14	DRFA / DRFB / DRFC / DRFD / DRFE	A2C5328876880	12
2.2 TDCi	92 kW	10/11→08/14	CYFA / CYFB / CYFC / CYFD	A2C5328876880	12
2.2 TDCi 4x4	92 kW	10/11→08/14	CYRB / CYRC	A2C5328876880	12
2.2 TDCi RWD	74 kW	10/11→08/14	DRRR / DRRB / DRRC	A2C5328876880	12
2.2 TDCi RWD	92 kW	10/11→08/14	CYRA / CYRB	A2C5328876880	12
2.2 TDCi RWD	114 kW	10/11→08/14	CVRA / CVRB / CVRC	A2C5328876880	12



					VDO	
LAND ROVER - DISCOVERY IV (L319) 09/09→						
Common Rail Diesel Injector						
2.7 TD 4x4	140 kW	09/09→	276DT; AA000001		A2C59513553	17
			276DT		A2C59513553	17
Diesel Common Rail Pump						
2.7 TD 4x4	140 kW	09/09→	276DT; AA000001		A2C59513482	17
			276DT		A2C59513482	17
LAND ROVER - RANGE ROVER III (L322) 03/02→12/12						
Common Rail Diesel Injector						
3.6 D 4x4	200 kW	04/06→08/12	368DT; 7A000001		A2C59513597	19
Diesel Common Rail Pump						
3.6 D 4x4	200 kW	04/06→08/12	368DT; 7A000001 → 8A273645		A2C59513481	17
			368DT; 8A273646		A2C59513481	17
LAND ROVER - RANGE ROVER SPORT (L320) 02/05→03/13						
Common Rail Diesel Injector						
2.7 D 4x4	140 kW	02/05→03/13	276DT		A2C59511364	13
			276DT; 7A000001		A2C59513553	17
3.6 D 4x4	200 kW	04/06→03/13	368DT; 7A000001		A2C59513597	19
Diesel Common Rail Pump						
2.7 D 4x4	140 kW	02/05→03/13	276DT; → 8A999999; Service exchange part (C121)		A2C1283180085	11
			276DT; Service exchange part (C121)		A2C1283180085	11
			276DT; 9A000001 ; Service exchange part (C121)		A2C1283180085	11
			276DT		A2C59511314	13
			276DT; → 8A999999		A2C59511314	13
			276DT; 9A000001		A2C59511314	13
			276DT; 9A211715		A2C59513482	17
			276DT; 8A147002 → 9A211714		A2C59513482	17
			276DT; 7A000001 → 8A147001		A2C59513482	17
			276DT; 7A000001 → 9A211714		A2C59513482	17
3.6 D 4x4	200 kW	04/06→03/13	368DT; 7A000001 → 8A273645		A2C59513481	17
			368DT; 8A273646		A2C59513481	17
MAZDA - 3 (BL) 12/08→09/14						
Common Rail Diesel Injector						
1.6 MZR CD	85 kW	09/10→05/13	Y650 / Y655; 02/12 ; BL1***532084		A2C59513556	18
Diesel Common Rail Pump						
1.6 MZR CD	85 kW	09/10→05/13	Y650 / Y655; 07/11		A2C59513829	19
MAZDA - 3 Saloon (BL) 12/08→						
Common Rail Diesel Injector						
1.6 MZR CD	85 kW	09/10→05/13	Y650 / Y655; 02/12 ; BL1***532084		A2C59513556	18
Diesel Common Rail Pump						
1.6 MZR CD	85 kW	09/10→05/13	Y650 / Y655; 07/11		A2C59513829	19
MAZDA - 5 (CW) 09/10→						
Common Rail Diesel Injector						
1.6 CD	85 kW	09/10→	Y650 / Y655; 02/12 ; CW*9**135367		A2C59513556	18
Diesel Common Rail Pump						
1.6 CD	85 kW	09/10→	Y650 / Y655		A2C59513829	19



     	
MERCEDES-BENZ - A-CLASS (W176) 06/12→	
	Common Rail Diesel Injector
A 180 CDI / d (176.012) 80 kW 06/12→	OM 607.951 A2C59507596 12
	Diesel Common Rail Pump
A 180 CDI / d (176.012) 80 kW 06/12→	OM 607.951 A2C59507608 13
MERCEDES-BENZ - B-CLASS (W246, W242) 10/11→	
	Common Rail Diesel Injector
B 180 CDI / d (246.212) 80 kW 02/13→	OM 607.951 A2C59507596 12
	Diesel Common Rail Pump
B 180 CDI / d (246.212) 80 kW 02/13→	OM 607.951 A2C59507608 13
MERCEDES-BENZ - CITAN Box (415) 11/12→	
	Common Rail Diesel Injector
111 CDI (415.603, 415.605) 81 kW 06/13→	OM 607.951 A2C59507596 12
	Diesel Common Rail Pump
111 CDI (415.603, 415.605) 81 kW 06/13→	OM 607.951 A2C59507608 13
MERCEDES-BENZ - CITAN Combi (415) 11/12→	
	Common Rail Diesel Injector
111 CDI (415.703) 81 kW 06/13→	OM 607.951 A2C59507596 12
	Diesel Common Rail Pump
111 CDI (415.703) 81 kW 06/13→	OM 607.951 A2C59507608 13
MERCEDES-BENZ - CITAN Mixto (415) 11/12→	
	Common Rail Diesel Injector
111 CDI (415.601, 415.603, 415.605) 81 kW 06/13→	OM 607.951 A2C59507596 12
	Diesel Common Rail Pump
111 CDI (415.601, 415.603, 415.605) 81 kW 06/13→	OM 607.951 A2C59507608 13
MERCEDES-BENZ - CLA Coupe (C117) 01/13→	
	Common Rail Diesel Injector
CLA 180 CDI / d (117.312) 80 kW 10/13→	OM 607.951 A2C59507596 12
	Diesel Common Rail Pump
CLA 180 CDI / d (117.312) 80 kW 10/13→	OM 607.951 A2C59507608 13
MERCEDES-BENZ - CLA Shooting Brake (X117) 01/15→	
	Common Rail Diesel Injector
CLA 180 d (117.912) 80 kW 07/15→	OM 607.951 A2C59507596 12
	Diesel Common Rail Pump
CLA 180 d (117.912) 80 kW 07/15→	OM 607.951 A2C59507608 13
MERCEDES-BENZ - GLA-CLASS (X156) 12/13→	
	Common Rail Diesel Injector
GLA 180 CDI / d (156.912) 80 kW 07/14→	OM 607.951 A2C59507596 12



				VDO	
MERCEDES-BENZ - GLA-CLASS (X156) 12/13→					
Diesel Common Rail Pump					
GLA 180 CDI / d (156.912)	80 kW	07/14→	OM 607.951	A2C59507608	13
NISSAN - CUBE (Z12) 09/07→					
Common Rail Diesel Injector					
1.5 dCi	81 kW	03/10→		A2C59513484	17
Diesel Common Rail Pump					
1.5 dCi	81 kW	03/10→		A2C59513595	18
NISSAN - JUKE (F15) 06/10→					
Common Rail Diesel Injector					
1.5 dCi	81 kW	06/10→	K9K 636	A2C59507596	12
			K9K 896	A2C59513484	17
Diesel Common Rail Pump					
1.5 dCi	81 kW	06/10→	K9K 636	A2C59507608	13
			K9K 896	A2C59513595	18
NISSAN - NOTE (E11, NE11) 01/05→08/13					
Common Rail Diesel Injector					
1.5 dCi	76 kW	07/08→06/12		A2C59511606	15
Diesel Common Rail Pump					
1.5 dCi	76 kW	07/08→06/12		A2C59511605	15
NISSAN - NV200 / EVALIA Bus 07/10→					
Common Rail Diesel Injector					
1.5 dci (M20, M20M)	81 kW	04/11→	K9K 636 / K9K 646	A2C59507596	12
Diesel Common Rail Pump					
1.5 dci (M20, M20M)	81 kW	04/11→	K9K 636 / K9K 646	A2C59507608	13
NISSAN - NV200 Box Body / Estate 02/10→					
Common Rail Diesel Injector					
1.5 dci (M20, M20M)	81 kW	04/11→	K9K 636 / K9K 646	A2C59507596	12
Diesel Common Rail Pump					
1.5 dci (M20, M20M)	81 kW	04/11→	K9K 636 / K9K 646	A2C59507608	13
NISSAN - QASHQAI / QASHQAI +2 I (J10, NJ10) 12/06→04/14					
Common Rail Diesel Injector					
1.5 dCi	78 kW	02/07→12/13		A2C59511606	15
1.5 dCi	81 kW	01/10→12/13		A2C59513484	17
Diesel Common Rail Pump					
1.5 dCi	78 kW	02/07→12/13		A2C59511605	15
1.5 dCi	81 kW	01/10→12/13	K9K 430	A2C59513595	18
NISSAN - QASHQAI II Closed Off-Road Vehicle (J11, J11_) 11/13→					
Common Rail Diesel Injector					
1.5 dCi	81 kW	11/13→	K9K 636	A2C59507596	12
Diesel Common Rail Pump					
1.5 dCi	81 kW	11/13→	K9K 636	A2C59507608	13



NISSAN - TIIDA Hatchback (C11) 05/04→12/13					
Common Rail Diesel Injector					
1.5 dCi	78 kW	09/07→12/11		A2C59511606	15
Diesel Common Rail Pump					
1.5 dCi	78 kW	09/07→12/11		A2C59511605	15
NISSAN - TIIDA Saloon (SC11) 05/04→12/13					
Common Rail Diesel Injector					
1.5 dCi	78 kW	09/07→12/12		A2C59511606	15
Diesel Common Rail Pump					
1.5 dCi	78 kW	09/07→12/12		A2C59511605	15
PEUGEOT - 107 06/05→					
Common Rail Diesel Injector					
1.4 HDi	40 kW	06/05→05/14	8HT (DV4TD)	A2C59511612	16
Diesel Common Rail Pump					
1.4 HDi	40 kW	06/05→05/14	8HT (DV4TD)	5WS40008-Z	8
PEUGEOT - 207 CC (WD_) 02/07→					
Common Rail Diesel Injector					
1.6 HDi	82 kW	08/09→	9HR (DV6C); 12/11	A2C59513556	18
			9HR (DV6C); 03/10	A2C59513556	18
Diesel Common Rail Pump					
1.6 HDi	82 kW	08/09→	9HR (DV6C); 07/10	A2C59513830	19
			9HR (DV6C); 06/10	A2C59513830	19
PEUGEOT - 207 SW (WK_) 02/07→					
Common Rail Diesel Injector					
1.6 HDi	82 kW	08/09→	9HR (DV6C); 12/11	A2C59513556	18
			9HR (DV6C); 03/10	A2C59513556	18
			9HR (DV6C); 03/10 12/11	A2C59513556	18
Diesel Common Rail Pump					
1.6 HDi	82 kW	08/09→	9HR (DV6C); 07/10	A2C59513830	19
			9HR (DV6C); 06/10	A2C59513830	19
PEUGEOT - 208 (CA_, CC_) 03/12→					
Common Rail Diesel Injector					
1.6 HDi	84 kW	03/12→		A2C59513556	18
Diesel Common Rail Pump					
1.6 HDi	84 kW	03/12→		A2C59513830	19
PEUGEOT - 307 (3A/C) 08/00→04/12					
Common Rail Diesel Injector					
2.0 HDi 135	100 kW	10/03→11/07	RHR (DW10BTED4); Version (C2): Class 4	5WS40156-4Z	9
			RHR (DW10BTED4); Version (C2): Class 5	5WS40156-Z	10
			RHR (DW10BTED4); Version (C2): Class 6	A2C59511601	14
			RHR (DW10BTED4); Version (C2): Class M	A2C59511603	15
2.0 HDi 90	66 kW	08/00→03/07	RHY (DW10TD)	5WS40000-Z	8
Diesel Common Rail Pump					
2.0 HDi 135	100 kW	10/03→11/07	RHR (DW10BTED4)	5WS40809-Z	10
			RHR (DW10BTED4); Service exchange part (C121)	A2C1283160085	11
2.0 HDi 90	66 kW	08/00→03/07	RHY (DW10TD)	5WS40018-Z	8



					VDO	
PEUGEOT - 307 Break (3E) 03/02→12/09						
Common Rail Diesel Injector						
2.0 HDi 135	100 kW	02/04→04/08		RHR (DW10BTED4); Version (C2): Class 4	5WS40156-4Z	9
				RHR (DW10BTED4); Version (C2): Class 5	5WS40156-Z	10
				RHR (DW10BTED4); Version (C2): Class 6	A2C59511601	14
				RHR (DW10BTED4); Version (C2): Class M	A2C59511603	15
2.0 HDi 90	66 kW	03/02→04/08		RHY (DW10TD)	5WS40000-Z	8
Diesel Common Rail Pump						
2.0 HDi 135	100 kW	02/04→04/08		RHR (DW10BTED4)	5WS40809-Z	10
				RHR (DW10BTED4); Service exchange part (C121)	A2C1283160085	11
2.0 HDi 90	66 kW	03/02→04/08		RHY (DW10TD)	5WS40018-Z	8
PEUGEOT - 307 CC (3B) 03/03→06/09						
Common Rail Diesel Injector						
2.0 HDi 135	100 kW	06/05→04/09		RHR (DW10BTED4); Version (C2): Class 4	5WS40156-4Z	9
				RHR (DW10BTED4); Version (C2): Class 5	5WS40156-Z	10
				RHR (DW10BTED4); Version (C2): Class 6	A2C59511601	14
				RHR (DW10BTED4); Version (C2): Class M	A2C59511603	15
Diesel Common Rail Pump						
2.0 HDi 135	100 kW	06/05→04/09		RHR (DW10BTED4)	5WS40809-Z	10
				RHR (DW10BTED4); Service exchange part (C121)	A2C1283160085	11
PEUGEOT - 307 SW (3H) 03/02→12/09						
Common Rail Diesel Injector						
2.0 HDi 135	100 kW	02/04→04/08		RHR (DW10BTED4); Version (C2): Class 4	5WS40156-4Z	9
				RHR (DW10BTED4); Version (C2): Class 5	5WS40156-Z	10
				RHR (DW10BTED4); Version (C2): Class 6	A2C59511601	14
				RHR (DW10BTED4); Version (C2): Class M	A2C59511603	15
2.0 HDi 90	66 kW	03/02→04/08		RHY (DW10TD)	5WS40000-Z	8
Diesel Common Rail Pump						
2.0 HDi 135	100 kW	02/04→04/08		RHR (DW10BTED4)	5WS40809-Z	10
				RHR (DW10BTED4); Service exchange part (C121)	A2C1283160085	11
2.0 HDi 90	66 kW	03/02→04/08		RHY (DW10TD)	5WS40018-Z	8
PEUGEOT - 308 (4A_, 4C_) 09/07→						
Common Rail Diesel Injector						
1.6 HDi	66 kW	09/07→		12/11	A2C59513556	18
				12/11	A2C59513556	18
				03/10	A2C59513556	18
				03/10 - 12/11	A2C59513556	18
1.6 HDi	82 kW	12/09→		9HR (DV6C); 12/11	A2C59513556	18
				9HR (DV6C); 12/11	A2C59513556	18
				9HR (DV6C); 03/10 - 12/11	A2C59513556	18
				9HR (DV6C); 03/10	A2C59513556	18
1.6 HDi	84 kW	03/13→			A2C59513556	18
Diesel Common Rail Pump						
1.6 HDi	66 kW	09/07→		07/10	A2C59513830	19
				06/10	A2C59513830	19
1.6 HDi	82 kW	12/09→		9HR (DV6C); 06/10	A2C59513830	19
				9HR (DV6C); 07/10	A2C59513830	19
1.6 HDi	84 kW	03/13→			A2C59513830	19
PEUGEOT - 308 II 09/13→						
Common Rail Diesel Injector						
1.6 HDi	68 kW	09/13→			A2C59513556	18
1.6 HDi / BlueHDi 115	85 kW	09/13→				



VDO

PEUGEOT - 308 II 09/13→

Diesel Common Rail Pump

1.6 HDi	68 kW	09/13→		A2C59513830	19
1.6 HDi / BlueHDi 115	85 kW	09/13→			

PEUGEOT - 308 CC (4B_) 02/09→

Common Rail Diesel Injector

1.6 HDi	82 kW	06/09→	9HR (DV6C); 12/11	A2C59513556	18
			9HR (DV6C); 12/11	A2C59513556	18
			9HR (DV6C); 03/10 12/11	A2C59513556	18
			9HR (DV6C); 03/10	A2C59513556	18
1.6 HDi	84 kW	03/13→		A2C59513556	18

Diesel Common Rail Pump

1.6 HDi	82 kW	06/09→	9HR (DV6C); 07/10	A2C59513830	19
			9HR (DV6C); 06/10	A2C59513830	19
1.6 HDi	84 kW	03/13→		A2C59513830	19

PEUGEOT - 308 SW (4E_, 4H_) 09/07→

Common Rail Diesel Injector

1.6 HDi	82 kW	12/09→	9HR (DV6C); 12/11	A2C59513556	18
			9HR (DV6C); 12/11	A2C59513556	18
			9HR (DV6C); 03/10 12/11	A2C59513556	18
			9HR (DV6C); 03/10	A2C59513556	18
1.6 HDi	84 kW	03/13→03/17		A2C59513556	18

Diesel Common Rail Pump

1.6 HDi	82 kW	12/09→	9HR (DV6C); 07/10	A2C59513830	19
1.6 HDi	84 kW	03/13→03/17		A2C59513830	19

PEUGEOT - 406 (8B) 08/95→01/05

Common Rail Diesel Injector

2.0 HDi 90	66 kW	02/99→05/04	RHY (DW10TD)	5WS40000-Z	8
------------	-------	-------------	--------------	-------------------	---

Diesel Common Rail Pump

2.0 HDi 90	66 kW	02/99→05/04	RHY (DW10TD)	5WS40018-Z	8
------------	-------	-------------	--------------	-------------------	---

PEUGEOT - 406 Break (8E/F) 10/96→10/04

Common Rail Diesel Injector

2.0 HDi 90	66 kW	02/99→10/04	RHY (DW10TD)	5WS40000-Z	8
------------	-------	-------------	--------------	-------------------	---

Diesel Common Rail Pump

2.0 HDi 90	66 kW	02/99→10/04	RHY (DW10TD)	5WS40018-Z	8
------------	-------	-------------	--------------	-------------------	---

PEUGEOT - 407 (6D_) 03/04→

Common Rail Diesel Injector

2.0 HDi	103 kW	06/09→12/10	RHF (DW10BTED4); Version (C2): Class 4	5WS40156-4Z	9
			RHR (DW10BTED4)	5WS40156-Z	10
			RHF (DW10BTED4); Version (C2): Class 6	A2C59511601	14
			RHF (DW10BTED4); RPO number from (C57): 10766	A2C59511603	15
2.0 HDi 135	100 kW	05/04→	RHR (DW10BTED4); Version (C2): Class 4	5WS40156-4Z	9
			RHR (DW10BTED4); Version (C2): Class 5	5WS40156-Z	10
			RHR (DW10BTED4); Version (C2): Class 6	A2C59511601	14
			RHR (DW10BTED4); RPO number from (C57): 10766	A2C59511603	15
2.7 HDi	150 kW	10/05→	UHZ (DT17)	A2C59511316	13

Diesel Common Rail Pump

2.0 HDi	103 kW	06/09→12/10	RHR (DW10BTED4)	5WS40809-Z	10
2.0 HDi 135	100 kW	05/04→	RHR (DW10BTED4); Service exchange part (C121)	A2C1283160085	11
2.7 HDi	150 kW	10/05→	UHZ (DT17); Service exchange part (C121)	A2C1283180085	11
			UHZ (DT17)	A2C59511314	13



VDO

**PEUGEOT - 407 Coupe (6C_) 10/05→****Common Rail Diesel Injector**

2.0 HDi	100 kW	10/05→	RHR (DW10BTED4); Version (C2): Class 4	5WS40156-4Z	9
			RHR (DW10BTED4); Version (C2): Class 5	5WS40156-Z	10
			RHR (DW10BTED4); Version (C2): Class 6	A2C59511601	14
			RHR (DW10BTED4); RPO number from (C57): 10766	A2C59511603	15
2.0 HDi	103 kW	09/08→12/09	RHR (DW10BTED4); RPO number from (C57): 10766	A2C59511603	15
2.7 HDi	150 kW	10/05→	UHZ (DT17)	A2C59511316	13

**Diesel Common Rail Pump**

2.0 HDi	100 kW	10/05→	RHR (DW10BTED4)	5WS40809-Z	10
			RHR (DW10BTED4); Service exchange part (C121)	A2C1283160085	11
2.7 HDi	150 kW	10/05→	UHZ (DT17); Service exchange part (C121)	A2C1283180085	11
			UHZ (DT17)	A2C59511314	13

PEUGEOT - 407 SW (6E_) 05/04→**Common Rail Diesel Injector**

2.0 HDi	103 kW	08/08→	RHR (DW10BTED4); Version (C2): Class 4	5WS40156-4Z	9
2.0 HDi 135	100 kW	07/04→12/10	RHR (DW10BTED4); Version (C2): Class 5	5WS40156-Z	10
			RHR (DW10BTED4); Version (C2): Class 6	A2C59511601	14
			RHR (DW10BTED4); RPO number from (C57): 10766	A2C59511603	15
2.7 HDi	150 kW	10/05→	UHZ (DT17)	A2C59511316	13

**Diesel Common Rail Pump**

2.0 HDi	103 kW	08/08→	RHR (DW10BTED4)	5WS40809-Z	10
2.0 HDi 135	100 kW	07/04→12/10	RHR (DW10BTED4); Service exchange part (C121)	A2C1283160085	11
2.7 HDi	150 kW	10/05→	UHZ (DT17); Service exchange part (C121)	A2C1283180085	11
			UHZ (DT17)	A2C59511314	13

PEUGEOT - 508 I (8D_) 11/10→**Common Rail Diesel Injector**

1.6 HDi	82 kW	11/10→	9HR (DV6C); 12/11	A2C59513556	18
1.6 HDi	84 kW	02/12→	9HD (DV6CTED)	A2C59513556	18

**Diesel Common Rail Pump**

1.6 HDi	82 kW	11/10→	9HR (DV6C)	A2C59513830	19
1.6 HDi	84 kW	02/12→	9HD (DV6CTED)	A2C59513830	19

PEUGEOT - 508 SW I (8E_) 11/10→**Common Rail Diesel Injector**

1.6 HDi	82 kW	11/10→	9HR (DV6C); 12/11	A2C59513556	18
			9HR (DV6C); 12/11	A2C59513556	18
1.6 HDi	84 kW	02/12→	9HD (DV6CTED)	A2C59513556	18

**Diesel Common Rail Pump**

1.6 HDi	82 kW	11/10→	9HR (DV6C)	A2C59513830	19
1.6 HDi	84 kW	02/12→	9HD (DV6CTED)	A2C59513830	19

PEUGEOT - 607 (9D, 9U) 01/00→**Common Rail Diesel Injector**

2.0 HDi	100 kW	09/05→07/11	RHR (DW10BTED4)	5WS40156-Z	10
2.7 HDi 24V	150 kW	12/04→07/11	DT17TED4	A2C59511316	13

**Diesel Common Rail Pump**

2.0 HDi	100 kW	09/05→07/11	RHR (DW10BTED4)	5WS40809-Z	10
			RHR (DW10BTED4); Service exchange part (C121)	A2C1283160085	11
2.7 HDi 24V	150 kW	12/04→07/11	DT17TED4; Service exchange part (C121)	A2C1283180085	11
			DT17TED4	A2C59511314	13



VDO

PEUGEOT - 807 (E) 06/02→

Common Rail Diesel Injector

2.0 HDi	88 kW	02/06→		A2C59511602	14
2.0 HDi	100 kW	06/06→	RHR (DW10BTED4); Version (C2): Class 4	5WS40156-4Z	9
			RHR (DW10BTED4); Version (C2): Class 5	5WS40156-Z	10
			RHR (DW10BTED4); Version (C2): Class 6	A2C59511601	14

Diesel Common Rail Pump

2.0 HDi	88 kW	02/06→		5WS40809-Z	10
			Service exchange part (C121)	A2C1283160085	11
2.0 HDi	100 kW	06/06→	RHR (DW10BTED4)	5WS40809-Z	10
			RHR (DW10BTED4); Service exchange part (C121)	A2C1283160085	11

PEUGEOT - 1007 (KM_) 04/05→

Common Rail Diesel Injector

1.4 HDi	50 kW	04/05→	8HX (DV4TD)	5WS40148-Z	9
			8HZ (DV4TD)	A2C59511612	16

Diesel Common Rail Pump

1.4 HDi	50 kW	04/05→	8HZ (DV4TD)	5WS40008-Z	8
---------	-------	--------	-------------	-------------------	---

PEUGEOT - 2008 (CU_) 03/13→

Common Rail Diesel Injector

1.6 HDi	84 kW	03/13→	9HD (DV6CTED)	A2C59513556	18
---------	-------	--------	---------------	--------------------	----

Diesel Common Rail Pump

1.6 HDi	84 kW	03/13→	9HD (DV6CTED)	A2C59513830	19
---------	-------	--------	---------------	--------------------	----

PEUGEOT - 3008 MPV (0U_) 06/09→12/16

Common Rail Diesel Injector

1.6 HDi	80 kW	06/09→08/16	9HZ (DV6TED4); 07/10	A2C59513556	18
			9HZ (DV6TED4); 06/10	A2C59513556	18
1.6 HDi	82 kW	12/09→08/16	9HR (DV6C); 12/11	A2C59513556	18
			9HR (DV6C); 12/11	A2C59513556	18
1.6 HDi	84 kW	03/13→08/16	9HD (DV6CTED)	A2C59513556	18

Diesel Common Rail Pump

1.6 HDi	80 kW	06/09→08/16	9HZ (DV6TED4); 07/10	A2C59513830	19
			9HZ (DV6TED4); 06/10	A2C59513830	19
1.6 HDi	82 kW	12/09→08/16	9HR (DV6C)	A2C59513830	19
1.6 HDi	84 kW	03/13→08/16	9HD (DV6CTED)	A2C59513830	19

PEUGEOT - 4008 05/12→

Common Rail Diesel Injector

1.6 HDi AWC	84 kW	05/12→		A2C59513556	18
-------------	-------	--------	--	--------------------	----

Diesel Common Rail Pump

1.6 HDi AWC	84 kW	05/12→		A2C59513830	19
-------------	-------	--------	--	--------------------	----

PEUGEOT - 5008 (0U_, 0E_) 06/09→

Common Rail Diesel Injector

1.6 HDi	80 kW	09/09→	9HZ (DV6TED4); 07/10	A2C59513556	18
			9HZ (DV6TED4); 06/10	A2C59513556	18
1.6 HDi	82 kW	08/10→	9HR (DV6C); 12/11	A2C59513556	18
			9HR (DV6C); 12/11	A2C59513556	18
1.6 HDi	84 kW	03/13→	9HD (DV6CTED)	A2C59513556	18

Diesel Common Rail Pump

1.6 HDi	80 kW	09/09→	9HZ (DV6TED4); 07/10	A2C59513830	19
			9HZ (DV6TED4); 06/10	A2C59513830	19
1.6 HDi	82 kW	08/10→	9HR (DV6C)	A2C59513830	19



VDO

**PEUGEOT - 5008 (0U_, 0E_) 06/09→**

Diesel Common Rail Pump				
1.6 HDi	84 kW	03/13→	9HD (DV6CTED)	A2C59513830 19

PEUGEOT - BOXER Box 04/06→

Common Rail Diesel Injector				
2.0 BlueHDi 110	81 kW	07/15→		A2C59517051 21
2.0 BlueHDi 130	96 kW	07/15→	AHN (DW10FUD)	A2C59517051 21
2.2 HDi 110	81 kW	03/11→		A2C59517051 21
2.2 HDi 130	96 kW	03/11→		
2.2 HDi 150	110 kW	03/11→		

Diesel Common Rail Pump				
2.2 HDi 110	81 kW	03/11→		A2C59517045 20
2.2 HDi 130	96 kW	03/11→		
2.2 HDi 150	110 kW	03/11→		

PEUGEOT - BOXER Bus 09/05→

Common Rail Diesel Injector				
2.0 BlueHDi 110	81 kW	07/15→		A2C59517051 21
2.0 BlueHDi 130	96 kW	07/15→	AHN (DW10FUD)	A2C59517051 21
2.2 HDi 110	81 kW	03/11→		A2C59517051 21
2.2 HDi 130	96 kW	03/11→		
2.2 HDi 150	110 kW	03/11→		

Diesel Common Rail Pump				
2.2 HDi 110	81 kW	03/11→		A2C59517045 20
2.2 HDi 130	96 kW	03/11→		
2.2 HDi 150	110 kW	03/11→		

PEUGEOT - BOXER Platform/Chassis 04/06→

Common Rail Diesel Injector				
2.0 BlueHDi 110	81 kW	07/15→		A2C59517051 21
2.0 BlueHDi 130	96 kW	07/15→	AHN (DW10FUD)	A2C59517051 21
2.2 HDi 110	81 kW	03/11→		A2C59517051 21
2.2 HDi 130	96 kW	03/11→		
2.2 HDi 150	110 kW	03/11→		

Diesel Common Rail Pump				
2.2 HDi 110	81 kW	03/11→		A2C59517045 20
2.2 HDi 130	96 kW	03/11→		
2.2 HDi 150	110 kW	03/11→		

PEUGEOT - EXPERT Box (VF3A_, VF3U_, VF3X_) 01/07→

Common Rail Diesel Injector				
2.0 HDi 120	88 kW	01/07→		A2C59511602 14
2.0 HDi 140	100 kW	01/07→	RHR (DW10BTED4); Version (C2): Class 4	5WS40156-4Z 9
			RHR (DW10BTED4); Version (C2): Class 5	5WS40156-Z 10
			RHR (DW10BTED4); Version (C2): Class 6	A2C59511601 14

Diesel Common Rail Pump				
2.0 HDi 120	88 kW	01/07→		5WS40809-Z 10
			Service exchange part (C121)	A2C1283160085 11
2.0 HDi 140	100 kW	01/07→	RHR (DW10BTED4)	5WS40809-Z 10
			RHR (DW10BTED4); Service exchange part (C121)	A2C1283160085 11

PEUGEOT - EXPERT Platform/Chassis 01/07→

Common Rail Diesel Injector				
2.0 HDi 120	88 kW	01/07→		A2C59511602 14
2.0 HDi 140	100 kW	01/07→	RHR (DW10BTED4); Version (C2): Class 4	5WS40156-4Z 9
			RHR (DW10BTED4); Version (C2): Class 5	5WS40156-Z 10
			RHR (DW10BTED4); Version (C2): Class 6	A2C59511601 14



VDO

PEUGEOT - EXPERT Platform/Chassis 01/07→

Diesel Common Rail Pump

2.0 HDi 120	88 kW	01/07→		5WS40809-Z	10
			Service exchange part (C121)	A2C1283160085	11
2.0 HDi 140	100 kW	01/07→	RHR (DW10BTED4)	5WS40809-Z	10
			RHR (DW10BTED4); Service exchange part (C121)	A2C1283160085	11

PEUGEOT - EXPERT Tepee (VF3X_) 01/07→

Common Rail Diesel Injector

2.0 HDi 120	88 kW	01/07→		A2C59511602	14
2.0 HDi 120 4x4	88 kW	01/07→			
2.0 HDi 140	100 kW	01/07→	RHR (DW10BTED4); Version (C2): Class 4	5WS40156-4Z	9
			RHR (DW10BTED4); Version (C2): Class 5	5WS40156-Z	10
			RHR (DW10BTED4); Version (C2): Class 6	A2C59511601	14

Diesel Common Rail Pump

2.0 HDi 120	88 kW	01/07→		5WS40809-Z	10
2.0 HDi 120 4x4	88 kW	01/07→	Service exchange part (C121)	A2C1283160085	11
2.0 HDi 140	100 kW	01/07→	RHR (DW10BTED4)	5WS40809-Z	10
			RHR (DW10BTED4); Service exchange part (C121)	A2C1283160085	11

PEUGEOT - PARTNER Box 04/08→

Common Rail Diesel Injector

1.6 HDi	84 kW	03/13→	9HL (DV6C)	A2C59513556	18
1.6 HDi 90	68 kW	04/10→	12/11	A2C59513556	18
			12/11	A2C59513556	18

Diesel Common Rail Pump

1.6 HDi	84 kW	03/13→	9HL (DV6C)	A2C59513830	19
1.6 HDi 90	68 kW	04/10→	07/10	A2C59513830	19

PEUGEOT - PARTNER Box (5) 04/96→12/15

Common Rail Diesel Injector

2.0 HDi	66 kW	04/00→07/08	RHY (DW10TD)	5WS40000-Z	8
2.0 HDi 4x4	66 kW	04/04→08/05			

Diesel Common Rail Pump

2.0 HDi	66 kW	04/00→07/08	RHY (DW10TD)	5WS40018-Z	8
2.0 HDi 4x4	66 kW	04/04→08/05			

PEUGEOT - PARTNER Combispace (5F) 05/96→12/15

Common Rail Diesel Injector

2.0 HDi	66 kW	02/00→07/08	RHY (DW10TD)	5WS40000-Z	8
2.0 HDi 4x4	66 kW	04/04→08/05			

Diesel Common Rail Pump

2.0 HDi	66 kW	02/00→07/08	RHY (DW10TD)	5WS40018-Z	8
2.0 HDi 4x4	66 kW	04/04→08/05			

PEUGEOT - PARTNER Tepee 04/08→

Common Rail Diesel Injector

1.6 HDi	82 kW	08/10→	12/11	A2C59513556	18
			12/11	A2C59513556	18
1.6 HDi	84 kW	03/13→	9HL (DV6C)	A2C59513556	18

Diesel Common Rail Pump

1.6 HDi	82 kW	08/10→		A2C59513830	19
1.6 HDi	84 kW	03/13→	9HL (DV6C)	A2C59513830	19



VDO

**RENAULT - CAPTUR (J5_, H5_) 06/13→****Common Rail Diesel Injector**

1.5 dCi 110	81 kW	01/15→	K9K 646	A2C59507596	12
-------------	-------	--------	---------	--------------------	----

**Diesel Common Rail Pump**

1.5 dCi 110	81 kW	01/15→	K9K 646	A2C59507608	13
-------------	-------	--------	---------	--------------------	----

RENAULT - CLIO III (BR0/1, CR0/1) 01/05→**Common Rail Diesel Injector**

1.5 dCi (BR0H, CR0H, CR1S, BR1S)	78 kW	06/05→	K9K 764	A2C59511606	15
			K9K 774	A2C59513484	17

1.5 dCi (BR1C, CR1C)	76 kW	06/05→	K9K 772	A2C59511606	15
----------------------	-------	--------	---------	--------------------	----

**Diesel Common Rail Pump**

1.5 dCi (BR0H, CR0H, CR1S, BR1S)	78 kW	06/05→	K9K 764	A2C59511605	15
----------------------------------	-------	--------	---------	--------------------	----

			K9K 774	A2C59513595	18
--	--	--	---------	--------------------	----

1.5 dCi (BR1C, CR1C)	76 kW	06/05→	K9K 772	A2C59511605	15
----------------------	-------	--------	---------	--------------------	----

RENAULT - CLIO Grandtour (KR0/1_) 02/08→**Common Rail Diesel Injector**

1.5 dCi	65 kW	08/10→	K9K 772	A2C59511606	15
---------	-------	--------	---------	--------------------	----

1.5 dCi (KR0H, KR1S)	78 kW	02/08→12/12	K9K 764	A2C59511606	15
----------------------	-------	-------------	---------	--------------------	----

			K9K 774	A2C59513484	17
--	--	--	---------	--------------------	----

1.5 dCi (KR1C, KR1N)	76 kW	02/08→	K9K 772	A2C59511606	15
----------------------	-------	--------	---------	--------------------	----

**Diesel Common Rail Pump**

1.5 dCi	65 kW	08/10→	K9K 772	A2C59511605	15
---------	-------	--------	---------	--------------------	----

1.5 dCi (KR0H, KR1S)	78 kW	02/08→12/12	K9K 764	A2C59511605	15
----------------------	-------	-------------	---------	--------------------	----

			K9K 774	A2C59513595	18
--	--	--	---------	--------------------	----

1.5 dCi (KR1C, KR1N)	76 kW	02/08→	K9K 772	A2C59511605	15
----------------------	-------	--------	---------	--------------------	----

RENAULT - FLUENCE (L3_) 02/10→**Common Rail Diesel Injector**

1.5 dCi	70 kW	07/14→	K9K 826	A2C59513484	17
---------	-------	--------	---------	--------------------	----

1.5 dCi (L30B)	78 kW	02/10→	K9K 832	A2C59513484	17
----------------	-------	--------	---------	--------------------	----

1.5 dCi (L30D, L30L, L306, L33F, L33L, L33M, L33V, L33W)	81 kW	02/10→	K9K 836 / K9K 837	A2C59513484	17
--	-------	--------	-------------------	--------------------	----

			K9K 836 / K9K 837	A2C59513484	17
--	--	--	-------------------	--------------------	----

**Diesel Common Rail Pump**

1.5 dCi	70 kW	07/14→	K9K 826	A2C59513595	18
---------	-------	--------	---------	--------------------	----

1.5 dCi (L30B)	78 kW	02/10→	K9K 832	A2C59513595	18
----------------	-------	--------	---------	--------------------	----

1.5 dCi (L30D, L30L, L306, L33F, L33L, L33M, L33V, L33W)	81 kW	02/10→	K9K 836 / K9K 837	A2C59513595	18
--	-------	--------	-------------------	--------------------	----

			K9K 836 / K9K 837	A2C59513595	18
--	--	--	-------------------	--------------------	----

RENAULT - GRAND SCÉNIC III (JZ0/1_) 02/09→**Common Rail Diesel Injector**

1.5 dCi	70 kW	11/10→	K9K 846	A2C59513484	17
---------	-------	--------	---------	--------------------	----

1.5 dCi	78 kW	02/09→	K9K 832	A2C59513484	17
---------	-------	--------	---------	--------------------	----

1.5 dCi	81 kW	04/09→	K9K 636	A2C59507596	12
---------	-------	--------	---------	--------------------	----

			K9K 836 / K9K 837	A2C59513484	17
--	--	--	-------------------	--------------------	----

**Diesel Common Rail Pump**

1.5 dCi	70 kW	11/10→	K9K 846	A2C59513595	18
---------	-------	--------	---------	--------------------	----

1.5 dCi	78 kW	02/09→	K9K 832	A2C59513595	18
---------	-------	--------	---------	--------------------	----

1.5 dCi	81 kW	04/09→	K9K 636	A2C59507608	13
---------	-------	--------	---------	--------------------	----

			K9K 836 / K9K 837	A2C59513595	18
--	--	--	-------------------	--------------------	----



				VDO	
RENAULT - KADJAR (HA_, HL_) 06/15→					
Common Rail Diesel Injector					
1.5 dCi 110	81 kW	06/15→	K9K 646 / K9K 647	A2C59507596	12
Diesel Common Rail Pump					
1.5 dCi 110	81 kW	06/15→	K9K 646 / K9K 647	A2C59507608	13
RENAULT - KANGOO / GRAND KANGOO (KW0/1_) 02/08→					
Common Rail Diesel Injector					
1.5 dCi (KW0F)	76 kW	02/08→	K9K 806	A2C59511606	15
			K9K 804	A2C59511606	15
1.5 dCi 110	80 kW	09/10→	K9K 804	A2C59511606	15
1.5 dCi 110	81 kW	03/13→	K9K 636	A2C59507596	12
Diesel Common Rail Pump					
1.5 dCi (KW0F)	76 kW	02/08→	K9K 806	A2C59511605	15
			K9K 804	A2C59511605	15
1.5 dCi 110	80 kW	09/10→	K9K 804	A2C59511605	15
1.5 dCi 110	81 kW	03/13→	K9K 636	A2C59507608	13
RENAULT - KANGOO BE BOP (KW0/1_) 02/09→					
Common Rail Diesel Injector					
1.5 dCi	80 kW	06/09→	K9K 804	A2C59511606	15
1.5 dCi (KW0F)	76 kW	02/09→	K9K 806	A2C59511606	15
Diesel Common Rail Pump					
1.5 dCi	80 kW	06/09→	K9K 804	A2C59511605	15
1.5 dCi (KW0F)	76 kW	02/09→	K9K 806	A2C59511605	15
RENAULT - KANGOO Express (FW0/1_) 02/08→					
Common Rail Diesel Injector					
1.5 dCi (FW0F)	76 kW	02/08→	K9K 806	A2C59511606	15
1.5 dCi 110	80 kW	09/10→	K9K 804	A2C59511606	15
1.5 dCi 110	81 kW	09/13→	K9K 636	A2C59507596	12
Diesel Common Rail Pump					
1.5 dCi (FW0F)	76 kW	02/08→	K9K 806	A2C59511605	15
1.5 dCi 110	80 kW	09/10→	K9K 804	A2C59511605	15
1.5 dCi 110	81 kW	09/13→	K9K 636	A2C59507608	13
RENAULT - LAGUNA III (BT0/1) 10/07→12/15					
Common Rail Diesel Injector					
1.5 dCi (BT00, BT0A, BT0T, BT1J)	81 kW	10/07→12/15	K9K 780	A2C59511606	15
Diesel Common Rail Pump					
1.5 dCi (BT00, BT0A, BT0T, BT1J)	81 kW	10/07→12/15	K9K 780	A2C59511605	15
RENAULT - LAGUNA III Grandtour (KT0/1) 10/07→12/15					
Common Rail Diesel Injector					
1.5 dCi (KT0A)	81 kW	10/07→12/15	K9K 780	A2C59511606	15
Diesel Common Rail Pump					
1.5 dCi (KT0A)	81 kW	10/07→12/15	K9K 780	A2C59511605	15
RENAULT - LAGUNA Coupe (DT0/1) 09/08→12/15					
Common Rail Diesel Injector					
1.5 dCi	81 kW	03/12→12/15	K9K 846	A2C59513484	17



				VDO	
RENAULT - LAGUNA Coupe (DT0/1) 09/08→12/15					
Diesel Common Rail Pump					
1.5 dCi	81 kW	03/12→12/15	K9K 846	A2C59513595	18
RENAULT - LATITUDE (L70_) 07/10→					
Common Rail Diesel Injector					
1.5 dCi (L70R)	81 kW	07/10→	K9K 782	A2C59513484	17
Diesel Common Rail Pump					
1.5 dCi (L70R)	81 kW	07/10→	K9K 782	A2C59513595	18
RENAULT - MEGANE II (BM0/1_, CM0/1_) 07/01→10/12					
Common Rail Diesel Injector					
1.5 dCi (BM16, CM16)	76 kW	01/07→03/09	K9K 734	A2C59511606	15
1.5 dCi (BM1E, CM1E)	78 kW	05/05→06/08			
Diesel Common Rail Pump					
1.5 dCi (BM16, CM16)	76 kW	01/07→03/09	K9K 734	A2C59511605	15
1.5 dCi (BM1E, CM1E)	78 kW	05/05→06/08			
RENAULT - MEGANE II Coupé-Cabriolet (EM0/1_) 09/03→03/10					
Common Rail Diesel Injector					
1.5 dCi (EM16)	76 kW	01/07→06/09	K9K 734	A2C59511606	15
Diesel Common Rail Pump					
1.5 dCi (EM16)	76 kW	01/07→06/09	K9K 734	A2C59511605	15
RENAULT - MEGANE II Estate (KM0/1_) 08/03→08/12					
Common Rail Diesel Injector					
1.5 dCi (KM16, KM1E)	78 kW	05/05→06/08	K9K 734	A2C59511606	15
Diesel Common Rail Pump					
1.5 dCi (KM16, KM1E)	78 kW	05/05→06/08	K9K 734	A2C59511605	15
RENAULT - MEGANE II Saloon (LM0/1_) 08/03→					
Common Rail Diesel Injector					
1.5 dCi (LM16)	76 kW	10/03→12/10	K9K 734	A2C59511606	15
Diesel Common Rail Pump					
1.5 dCi (LM16)	76 kW	10/03→12/10	K9K 734	A2C59511605	15
RENAULT - MEGANE III Coupe (DZ0/1_) 11/08→					
Common Rail Diesel Injector					
1.5 dCi	70 kW	07/14→	K9K 846	A2C59513484	17
1.5 dCi (DZ09, DZ0D, DZ1F, DZ1G)	81 kW	02/09→	K9K J 836 / K9K 837	A2C59513484	17
Diesel Common Rail Pump					
1.5 dCi	70 kW	07/14→	K9K 846	A2C59513595	18
1.5 dCi (DZ09, DZ0D, DZ1F, DZ1G)	81 kW	02/09→	K9K J 836 / K9K 837	A2C59513595	18
RENAULT - MEGANE III Grandtour (KZ0/1) 11/08→					
Common Rail Diesel Injector					
1.5 dCi	70 kW	11/13→	K9K 846	A2C59513484	17
1.5 dCi (KZ09, KZ0D, KZ1G)	81 kW	02/09→	K9K 636	A2C59507596	12
			K9K 836 / K9K 837 / K9K 846	A2C59513484	17
1.5 dCi (KZ1M, KZ1W)	78 kW	02/09→	K9K 836 / K9K 846	A2C59513484	17
Diesel Common Rail Pump					
1.5 dCi	70 kW	11/13→	K9K 846	A2C59513595	18



VDO

RENAULT - MEGANE III Grandtour (KZ0/1) 11/08→

Diesel Common Rail Pump

1.5 dCi (KZ09, KZ0D, KZ1G)	81 kW	02/09→	K9K 636	A2C59507608	13
			K9K 836 / K9K 837 / K9K 846	A2C59513595	18
1.5 dCi (KZ1M, KZ1W)	78 kW	02/09→	K9K 836 / K9K 846	A2C59513595	18

RENAULT - MEGANE III Hatchback (BZ0/1_) 11/08→

Common Rail Diesel Injector

1.5 dCi (BZ09, BZ0D)	81 kW	02/09→	K9K 636	A2C59507596	12
			K9K 836 / K9K 837 / K9K 846	A2C59513484	17
1.5 dCi (BZ1G, BZ1W, BZ0R)	70 kW	11/13→	K9K 846	A2C59513484	17

Diesel Common Rail Pump

1.5 dCi (BZ09, BZ0D)	81 kW	02/09→	K9K 636	A2C59507608	13
			K9K 836 / K9K 837 / K9K 846	A2C59513595	18
1.5 dCi (BZ1G, BZ1W, BZ0R)	70 kW	11/13→	K9K 846	A2C59513595	18

RENAULT - MEGANE CC (EZ0/1_) 06/10→

Common Rail Diesel Injector

1.5 dCi (EZ09, EZ1G, EZ0D)	81 kW	06/10→	K9K 836	A2C59513484	17
----------------------------	-------	--------	---------	--------------------	----

Diesel Common Rail Pump

1.5 dCi (EZ09, EZ1G, EZ0D)	81 kW	06/10→	K9K 836	A2C59513595	18
----------------------------	-------	--------	---------	--------------------	----

RENAULT - MODUS / GRAND MODUS (F/JP0_) 09/04→

Common Rail Diesel Injector

1.5 dCi (JP02)	76 kW	05/07→	K9K 772	A2C59511606	15
1.5 dCi (JP0G, JP0H)	78 kW	05/05→	K9K 764	A2C59511606	15

Diesel Common Rail Pump

1.5 dCi (JP02)	76 kW	05/07→	K9K 772	A2C59511605	15
1.5 dCi (JP0G, JP0H)	78 kW	05/05→	K9K 764	A2C59511605	15

RENAULT - SCÉNIC II (JM0/1_) 06/03→

Common Rail Diesel Injector

1.5 dCi (JM16)	76 kW	01/07→	K9K 734	A2C59511606	15
----------------	-------	--------	---------	--------------------	----

Diesel Common Rail Pump

1.5 dCi (JM16)	76 kW	01/07→	K9K 734	A2C59511605	15
----------------	-------	--------	---------	--------------------	----

RENAULT - SCÉNIC III (JZ0/1_) 12/08→

Common Rail Diesel Injector

1.5 dCi	78 kW	02/09→	K9K 832	A2C59513484	17
1.5 dCi	81 kW	04/09→	K9K 636	A2C59507596	12
			K9K 836 / K9K 837	A2C59513484	17
1.5 dCi (JZ02, JZ0R)	70 kW	11/10→	K9K 846	A2C59513484	17

Diesel Common Rail Pump

1.5 dCi	78 kW	02/09→	K9K 832	A2C59513595	18
1.5 dCi	81 kW	04/09→	K9K 636	A2C59507608	13
			K9K 836 / K9K 837	A2C59513595	18
1.5 dCi (JZ02, JZ0R)	70 kW	11/10→	K9K 846	A2C59513595	18

SEAT - ALTEA (5P1) 03/04→

Common Rail Diesel Injector

1.6 TDI	66 kW	11/10→	CAYB	A2C9626040080	22
1.6 TDI	77 kW	10/09→	CAYC	A2C9626040080	22



					VDO	
SEAT - ALTEA (5P1) 03/04→						
Diesel Common Rail Pump						
1.6 TDI	66 kW	11/10→		CAYB	A2C59517047	20
1.6 TDI	77 kW	10/09→		CAYC	A2C59517047	20
SEAT - ALTEA XL (5P5, 5P8) 10/06→						
Common Rail Diesel Injector						
1.6 TDI	66 kW	11/10→		CAYB	A2C9626040080	22
1.6 TDI	77 kW	10/09→		CAYC	A2C9626040080	22
Diesel Common Rail Pump						
1.6 TDI	66 kW	11/10→		CAYB	A2C59517047	20
1.6 TDI	77 kW	10/09→		CAYC	A2C59517047	20
SEAT - IBIZA IV (6J5, 6P1) 03/08→						
Common Rail Diesel Injector						
1.6 TDI	66 kW	05/09→		CAYB; → 6J-9-000001	A2C9626040080	22
1.6 TDI	77 kW	05/09→		CLNA / CAYC; → 6J-9-000001	A2C9626040080	22
Diesel Common Rail Pump						
1.6 TDI	66 kW	05/09→		CAYB; → 6J-9-000001	A2C59517047	20
1.6 TDI	77 kW	05/09→		CAYC; → 6J-9-000001	A2C59517047	20
SEAT - IBIZA IV SPORTCOUPE (6J1, 6P5) 07/08→						
Common Rail Diesel Injector						
1.6 TDI	66 kW	05/09→		CAYB; → 6J-9-000001	A2C9626040080	22
1.6 TDI	77 kW	05/09→		CLNA / CAYC; → 6J-9-000001	A2C9626040080	22
Diesel Common Rail Pump						
1.6 TDI	66 kW	05/09→		CAYB; → 6J-9-000001	A2C59517047	20
1.6 TDI	77 kW	05/09→		CAYC; → 6J-9-000001	A2C59517047	20
SEAT - IBIZA IV ST (6J8, 6P8) 03/10→						
Common Rail Diesel Injector						
1.6 TDI	66 kW	03/10→		CAYB; → 6J-9-000001	A2C9626040080	22
1.6 TDI	77 kW	03/10→		CLNA / CAYC; → 6J-9-000001	A2C9626040080	22
Diesel Common Rail Pump						
1.6 TDI	66 kW	03/10→		CAYB; → 6J-9-000001	A2C59517047	20
1.6 TDI	77 kW	03/10→		CAYC; → 6J-9-000001	A2C59517047	20
SEAT - LEON (1P1) 05/05→12/13						
Common Rail Diesel Injector						
1.6 TDI	66 kW	11/10→12/12		CAYB	A2C9626040080	22
1.6 TDI	77 kW	02/10→12/12		CAYC	A2C9626040080	22
Diesel Common Rail Pump						
1.6 TDI	66 kW	11/10→12/12		CAYB	A2C59517047	20
1.6 TDI	77 kW	02/10→12/12		CAYC; → 1P-6-000 001	A2C59517047	20
SEAT - TOLEDO IV (KG3) 07/12→						
Common Rail Diesel Injector						
1.6 TDI	77 kW	07/12→		CAYC / CLNA	A2C9626040080	22
Diesel Common Rail Pump						
1.6 TDI	66 kW	06/13→		CAYB; for PR number (C11): 7MJ	A2C59517047	20
1.6 TDI	77 kW	07/12→		CAYC / CLNA; for PR number (C11): 7MJ	A2C59517047	20



VDO

SKODA - FABIA II (542) 12/06→12/14

Common Rail Diesel Injector

1.6 TDI	66 kW	03/10→12/14	CAYB; Model year from (C20): 2011	A2C9626040080	22
1.6 TDI	77 kW	03/10→12/14	CAYC; Model year from (C20): 2011	A2C9626040080	22

Diesel Common Rail Pump

1.6 TDI	55 kW	04/10→12/14	CAYA	A2C59517047	20
1.6 TDI	66 kW	03/10→12/14	CAYB	A2C59517047	20
1.6 TDI	77 kW	03/10→12/14	CAYC	A2C59517047	20

SKODA - FABIA II Combi (545) 10/07→12/14

Common Rail Diesel Injector

1.6 TDI	66 kW	03/10→12/14	CAYB; Model year from (C20): 2011	A2C9626040080	22
1.6 TDI	77 kW	03/10→12/14	CAYC; Model year from (C20): 2011	A2C9626040080	22

Diesel Common Rail Pump

1.6 TDI	55 kW	04/10→12/14	CAYA	A2C59517047	20
1.6 TDI	66 kW	03/10→12/14	CAYB	A2C59517047	20
1.6 TDI	77 kW	03/10→12/14	CAYC	A2C59517047	20

SKODA - OCTAVIA II (1Z3) 02/04→06/13

Common Rail Diesel Injector

1.6 TDI	77 kW	06/09→04/13	CAYC	A2C9626040080	22
---------	-------	-------------	------	----------------------	----

Diesel Common Rail Pump

1.6 TDI	77 kW	06/09→04/13	CAYC; → 1Z-9-000 001	A2C59517047	20
---------	-------	-------------	-----------------------	--------------------	----

SKODA - OCTAVIA II Combi (1Z5) 02/04→06/13

Common Rail Diesel Injector

1.6 TDI	77 kW	06/09→04/13	CAYC	A2C9626040080	22
---------	-------	-------------	------	----------------------	----

Diesel Common Rail Pump

1.6 TDI	77 kW	06/09→04/13	CAYC; → 1Z-9-000 001	A2C59517047	20
1.6 TDI 4x4	77 kW	06/09→02/13	CAYC; → 1Z-9-000001	A2C59517047	20

SKODA - RAPID (NH3) 07/12→

Common Rail Diesel Injector

1.6 TDI	66 kW	08/13→	CAYB	A2C9626040080	22
1.6 TDI	77 kW	07/12→	CLNA	A2C9626040080	22

Diesel Common Rail Pump

1.6 TDI	66 kW	08/13→	CAYB; for PR number (C11): 7MJ, 7MG	A2C59517047	20
1.6 TDI	77 kW	07/12→	CLNA / CAYC; for PR number (C11): 7MJ, 7MG	A2C59517047	20
			CLNA	A2C59517049	20

SKODA - RAPID Spaceback (NH1) 07/12→

Diesel Common Rail Pump

1.6 TDI	66 kW	08/13→	CAYB; for PR number (C11): 7MJ, 7MG	A2C59517047	20
1.6 TDI	77 kW	07/12→	CLNA / CAYC; for PR number (C11): 7MJ, 7MG	A2C59517047	20
			CLNA	A2C59517049	20

SKODA - ROOMSTER (5J) 03/06→05/15

Common Rail Diesel Injector

1.6 TDI	66 kW	03/10→05/15	CAYB	A2C9626040080	22
1.6 TDI	77 kW	03/10→05/15	CAYC	A2C9626040080	22

Diesel Common Rail Pump

1.6 TDI	66 kW	03/10→05/15	CAYB	A2C59517047	20
1.6 TDI	77 kW	03/10→05/15	CAYC	A2C59517047	20



				VDO	
SKODA - ROOMSTER Praktik (5J) 03/07→05/15					
Common Rail Diesel Injector					
1.6 TDI	66 kW	03/10→05/15	CAYB	A2C9626040080	22
Diesel Common Rail Pump					
1.6 TDI	66 kW	03/10→05/15	CAYB	A2C59517047	20
SKODA - SUPERB II (3T4) 03/08→05/15					
Common Rail Diesel Injector					
1.6 TDI	77 kW	09/10→05/15	CAYC; → 3T-8-000001	A2C9626040080	22
Diesel Common Rail Pump					
1.6 TDI	77 kW	09/10→05/15	CAYC; → 3T-8-000 001	A2C59517047	20
SKODA - SUPERB II Estate (3T5) 10/09→05/15					
Common Rail Diesel Injector					
1.6 TDI	77 kW	09/10→05/15	CAYC; → 3T-8-000001	A2C9626040080	22
Diesel Common Rail Pump					
1.6 TDI	77 kW	09/10→05/15	CAYC; → 3T-8-000 001	A2C59517047	20
SKODA - YETI (5L) 05/09→12/17					
Common Rail Diesel Injector					
1.6 TDI	77 kW	11/10→05/15	CAYC	A2C9626040080	22
Diesel Common Rail Pump					
1.6 TDI	77 kW	11/10→05/15	CAYC	A2C59517047	20
TOYOTA - AYGO (B1) 02/05→05/14					
Common Rail Diesel Injector					
1.4 HDi (WNB10_)	40 kW	07/05→08/10	2WZ-TV	A2C59511612	16
Diesel Common Rail Pump					
1.4 HDi (WNB10_)	40 kW	07/05→08/10	2WZTV	5WS40008-Z	8
VOLVO - C30 (533) 09/06→12/13					
Common Rail Diesel Injector					
1.6 D2	84 kW	10/10→12/12	D 4162 T	A2C59513556	18
2.0 D	100 kW	10/06→12/12	D 4204 T; Version (C2): Class 4	5WS40156-4Z	9
			D 4204 T; Version (C2): Class 5	5WS40156-Z	10
Diesel Common Rail Pump					
1.6 D2	84 kW	10/10→12/12	D 4162 T	A2C59513829	19
2.0 D	100 kW	10/06→12/12	D 4204 T	A2C59511600	14
VOLVO - C70 II Convertible (542) 03/06→12/13					
Common Rail Diesel Injector					
2.0 D	100 kW	01/08→10/09	D 4204 T; Version (C2): Class 4	5WS40156-4Z	9
			D 4204 T; Version (C2): Class 5	5WS40156-Z	10
Diesel Common Rail Pump					
2.0 D	100 kW	01/08→10/09	D 4204 T	A2C59511600	14
VOLVO - S40 II (544) 12/03→12/12					
Common Rail Diesel Injector					
1.6 D2	84 kW	10/10→12/12	D 4162 T	A2C59513556	18
2.0 D	100 kW	01/04→12/10	D 4204 T; Version (C2): Class 4	5WS40156-4Z	9
			D 4204 T; Version (C2): Class 5	5WS40156-Z	10



VDO

VOLVO - S40 II (544) 12/03→12/12

Diesel Common Rail Pump					
1.6 D2	84 kW	10/10→12/12	D 4162 T	A2C59513829	19
2.0 D	100 kW	01/04→12/10	D 4204 T	A2C59511600	14

VOLVO - S60 II (134) 04/10→

Common Rail Diesel Injector					
DRIVE / D2	84 kW	01/11→12/15	D 4162 T	A2C59513556	18
Diesel Common Rail Pump					
DRIVE / D2	84 kW	01/11→12/15	D 4162 T	A2C59513829	19

VOLVO - S80 II (124) 03/06→

Common Rail Diesel Injector					
1.6 DRIVE	84 kW	06/11→	D 4162 T	A2C59513556	18
2.0 TDi	100 kW	02/08→03/11	D 4204 T; Version (C2): Class 4	5WS40156-4Z	9
			D 4204 T; Version (C2): Class 5	5WS40156-Z	10
Diesel Common Rail Pump					
1.6 DRIVE	84 kW	06/11→	D 4162 T	A2C59513829	19
2.0 TDi	100 kW	02/08→03/11	D 4204 T	A2C59511600	14

VOLVO - V40 Hatchback (525, 526) 03/12→

Common Rail Diesel Injector					
D2	84 kW	03/12→	D 4162 T	A2C59513556	18
Diesel Common Rail Pump					
D2	84 kW	03/12→	D 4162 T	A2C59513829	19

VOLVO - V50 (545) 12/03→12/12

Common Rail Diesel Injector					
1.6 D2	84 kW	01/10→12/12	D 4162 T	A2C59513556	18
2.0 D	100 kW	04/04→12/10	D 4204 T; Version (C2): Class 4	5WS40156-4Z	9
			D 4204 T; Version (C2): Class 5	5WS40156-Z	10
Diesel Common Rail Pump					
1.6 D2	84 kW	01/10→12/12	D 4162 T	A2C59513829	19
2.0 D	100 kW	04/04→12/10	D 4204 T	A2C59511600	14

VOLVO - V60 (155, 157) 07/10→

Common Rail Diesel Injector					
1.6 DRIVE	84 kW	02/11→12/15	D 4162 T	A2C59513556	18
Diesel Common Rail Pump					
1.6 DRIVE	84 kW	02/11→12/15	D 4162 T	A2C59513829	19

VOLVO - V70 III (135) 04/07→

Common Rail Diesel Injector					
1.6 DRIVE / D2	84 kW	04/11→12/15	D 4162 T	A2C59513556	18
2.0 D	100 kW	10/07→12/15	D 4204 T; Version (C2): Class 4	5WS40156-4Z	9
			D 4204 T; Version (C2): Class 5	5WS40156-Z	10
Diesel Common Rail Pump					
1.6 DRIVE / D2	84 kW	04/11→12/15	D 4162 T	A2C59513829	19
2.0 D	100 kW	10/07→12/15	D 4204 T	A2C59511600	14

VW - BEETLE (5C1, 5C2) 04/11→

Common Rail Diesel Injector					
1.6 TDi	77 kW	10/11→07/16	CAYC	A2C9626040080	22



VW - BEETLE (5C1, 5C2) 04/11→											
Diesel Common Rail Pump											
1.6 TDI	77 kW	10/11→07/16						A2C59517047			20
VW - BEETLE Convertible (5C7, 5C8) 12/11→											
Common Rail Diesel Injector											
1.6 TDI	77 kW	12/11→07/16		CAYC				A2C9626040080			22
Diesel Common Rail Pump											
1.6 TDI	77 kW	12/11→07/16		CAYC				A2C59517047			20
VW - CADDY III Box (2KA, 2KH, 2CA, 2CH) 03/04→05/15											
Common Rail Diesel Injector											
1.6 TDI	55 kW	08/10→05/15		CAYE;	→ 2K-B-200001			A2C9626040080			22
1.6 TDI	75 kW	08/10→05/15		CAYD;	→ 2K-B-200001			A2C9626040080			22
Diesel Common Rail Pump											
1.6 TDI	55 kW	08/10→05/15		CAYE;	→ 2K-B-200 001 ; for PR number (C11): 7MG, 7MQ, 7MJ			A2C59517047			20
1.6 TDI	75 kW	08/10→05/15		CAYD;	→ 2K-B-200 001 ; for PR number (C11): 7MG, 7MQ, 7MJ			A2C59517047			20
VW - CADDY III Estate (2KB, 2KJ, 2CB, 2CJ) 03/04→05/15											
Common Rail Diesel Injector											
1.6 TDI	55 kW	08/10→05/15		CAYE;	→ 2K-B-200001			A2C9626040080			22
1.6 TDI	75 kW	08/10→05/15		CAYD;	→ 2K-B-200001			A2C9626040080			22
Diesel Common Rail Pump											
1.6 TDI	55 kW	08/10→05/15		CAYE;	→ 2K-B-200 001 ; for PR number (C11): 7MG, 7MQ, 7MJ			A2C59517047			20
1.6 TDI	75 kW	08/10→05/15		CAYD;	→ 2K-B-200 001 ; for PR number (C11): 7MG, 7MQ, 7MJ			A2C59517047			20
VW - CADDY IV Box (SAA, SAH) 05/15→											
Common Rail Diesel Injector											
1.6 TDI	55 kW	05/15→11/17		CAYE				A2C9626040080			22
1.6 TDI	75 kW	05/15→		CAYD				A2C9626040080			22
Diesel Common Rail Pump											
1.6 TDI	55 kW	05/15→11/17		CAYE;	→ 2K-B-200 001 ; for PR number (C11): 7MG, 7MQ, 7MJ / TF3			A2C59517047			20
1.6 TDI	75 kW	05/15→		CAYD;	→ 2K-B-200 001 ; for PR number (C11): 7MG, 7MQ, 7MJ / TF3			A2C59517047			20
VW - CADDY IV Estate (SAB, SAJ) 05/15→											
Common Rail Diesel Injector											
1.6 TDI	55 kW	05/15→11/17		CAYE				A2C9626040080			22
1.6 TDI	75 kW	05/15→		CAYD				A2C9626040080			22
Diesel Common Rail Pump											
1.6 TDI	55 kW	05/15→11/17		CAYE;	→ 2K-B-200 001 ; for PR number (C11): 7MG, 7MQ, 7MJ / TF3			A2C59517047			20
1.6 TDI	75 kW	05/15→		CAYD;	→ 2K-B-200 001 ; for PR number (C11): 7MG, 7MQ, 7MJ / TF3			A2C59517047			20
VW - GOLF VI (5K1) 10/08→11/13											
Common Rail Diesel Injector											
1.6 TDI	66 kW	02/09→11/12		CAYB				A2C9626040080			22
1.6 TDI	77 kW	02/09→11/12		CAYC				A2C9626040080			22
Diesel Common Rail Pump											
1.6 TDI	66 kW	02/09→11/12		CAYB;	→ 1K-9-400 001			A2C59517047			20



VW - GOLF VI (5K1) 10/08→11/13					
Diesel Common Rail Pump					
1.6 TDI	77 kW	02/09→11/12	CAYC; → 1K-9-400 001	A2C59517047	20
VW - GOLF VI Convertible (517) 03/11→05/16					
Common Rail Diesel Injector					
1.6 TDI	77 kW	03/11→05/16	CAYC	A2C9626040080	22
Diesel Common Rail Pump					
1.6 TDI	77 kW	03/11→05/16	CAYC; for PR number (C11): TF3	A2C59517047	20
VW - GOLF VI Variant (AJ5) 07/09→07/13					
Common Rail Diesel Injector					
1.6 TDI	66 kW	12/09→07/13	CAYB	A2C9626040080	22
1.6 TDI	77 kW	07/09→07/13	CAYC	A2C9626040080	22
1.6 TDI 4motion	77 kW	07/09→07/13	CAYC; → 1K-9-400001	A2C9626040080	22
Diesel Common Rail Pump					
1.6 TDI	66 kW	12/09→07/13	CAYB; → 1K-9-400 001	A2C59517047	20
1.6 TDI	77 kW	07/09→07/13	CAYC; → 1K-9-400 001	A2C59517047	20
1.6 TDI 4motion	77 kW	07/09→07/13			
VW - GOLF PLUS (5M1, 521) 12/04→12/13					
Common Rail Diesel Injector					
1.6 TDI	66 kW	02/09→12/13	CAYB; → 1K-9-900001	A2C9626040080	22
1.6 TDI	77 kW	03/09→12/13	CAYC; → 1K-9-900001	A2C9626040080	22
Diesel Common Rail Pump					
1.6 TDI	66 kW	02/09→12/13	CAYB; → 1K-9-900 001	A2C59517047	20
1.6 TDI	77 kW	03/09→12/13	CAYC; → 1K-9-900 001	A2C59517047	20
VW - JETTA III (1K2) 09/04→10/10					
Common Rail Diesel Injector					
1.6 TDI	66 kW	12/09→10/10	CAYB	A2C9626040080	22
1.6 TDI	77 kW	06/09→10/10	CAYC	A2C9626040080	22
Diesel Common Rail Pump					
1.6 TDI	66 kW	12/09→10/10	CAYB	A2C59517047	20
1.6 TDI	77 kW	06/09→10/10	CAYC	A2C59517047	20
VW - JETTA IV (162, 163, AV3, AV2) 09/09→					
Common Rail Diesel Injector					
1.6 TDI	77 kW	04/10→07/14	CAYC; → 16-B-000001 / 16-F-000001	A2C9626040080	22
Diesel Common Rail Pump					
1.6 TDI	77 kW	04/10→07/14	CAYC; → 16-B-000 001 / 16-F-000 001	A2C59517047	20
VW - PASSAT (3C2) 03/05→12/10					
Common Rail Diesel Injector					
1.6 TDI	77 kW	08/09→07/10	CAYC	A2C9626040080	22
Diesel Common Rail Pump					
1.6 TDI	77 kW	08/09→07/10	CAYC	A2C59517047	20
VW - PASSAT (362) 08/10→12/14					
Common Rail Diesel Injector					
1.6 TDI	77 kW	08/10→12/14	CAYC; → 3C-B-200001	A2C9626040080	22
Diesel Common Rail Pump					
1.6 TDI	77 kW	08/10→12/14	CAYC; → 3C-B-200001	A2C59517049	20



					VDO	
VW - PASSAT Variant (3C5) 08/05→11/11						
Common Rail Diesel Injector						
1.6 TDI	77 kW	08/09→11/10		CAYC	A2C9626040080	22
Diesel Common Rail Pump						
1.6 TDI	77 kW	08/09→11/10		CAYC	A2C59517047	20
VW - PASSAT Variant (365) 08/10→12/15						
Common Rail Diesel Injector						
1.6 TDI	77 kW	08/10→12/14		CAYC; → 3C-B-200001	A2C9626040080	22
Diesel Common Rail Pump						
1.6 TDI	77 kW	08/10→12/14		CAYC; → 3C-B-200001	A2C59517049	20
VW - POLO (6R1, 6C1) 03/09→						
Common Rail Diesel Injector						
1.6 TDI	55 kW	06/09→		CAYA; → 6R-A-000001	A2C9626040080	22
1.6 TDI	66 kW	06/09→		CAYB; → 60-AT000001 / 6R-D-000001 / 6R-A-000001	A2C9626040080	22
1.6 TDI	77 kW	06/09→		CLNA; → 6R-A-000001 / 60-AT000001 / 6R-D-000001 / 60-FT000001	A2C9626040080	22
				CAYC; → 60-AT000001 / 6R-D-000001	A2C9626040080	22
Diesel Common Rail Pump						
1.6 TDI	55 kW	06/09→		CAYA; → 6R-A-000 001 / 6R-D-000 001 / 6R-D-000001 ; for PR number (C11): 7MG, 7MQ	A2C59517047	20
1.6 TDI	66 kW	06/09→		CAYB; → 6R-A-000 001 / 6R-D-000 001 ; for PR number (C11): 7MG, 7MQ	A2C59517047	20
1.6 TDI	77 kW	06/09→		CAYC / CLNA; → 6R-A-000 001 / 6R-D-000 001 ; for PR number (C11): 7MG, 7MQ	A2C59517047	20
				CLNA; → 60-AT000 001	A2C59517049	20
VW - TOURAN (1T3) 05/10→05/15						
Common Rail Diesel Injector						
1.6 TDI	66 kW	05/10→05/15		CAYB; Model year from (C20): 2011	A2C9626040080	22
1.6 TDI	77 kW	05/10→05/15		CAYC; Model year from (C20): 2011	A2C9626040080	22
Diesel Common Rail Pump						
1.6 TDI	66 kW	05/10→05/15		CAYB	A2C59517047	20
1.6 TDI	77 kW	05/10→05/15		CAYC	A2C59517047	20



Cross-Reference List

Referenzliste

Liste de référence

Lista de referencia

Lista di referenze

Список Литературы



Article-No.	OE-No./Ref.-No.	Manufacturer	Product Name
2910000177400	A2C53421318	Continental After-market GmbH	Common Rail Diesel Injector
2910000177400	A2C33349400	Continental After-market GmbH	Common Rail Diesel Injector
2910000177400	BH1Q-9K546-AB	LAND ROVER	Common Rail Diesel Injector
2910000177400	LR032067	LAND ROVER	Common Rail Diesel Injector
5WS40000-Z	5WS40000	Continental After-market GmbH	Common Rail Diesel Injector
5WS40000-Z	9652173780	CITROËN	Common Rail Diesel Injector
5WS40000-Z	1980F0	CITROËN	Common Rail Diesel Injector
5WS40000-Z	00001980F0	CITROËN	Common Rail Diesel Injector
5WS40000-Z	9652173780	PEUGEOT	Common Rail Diesel Injector
5WS40000-Z	1980F0	PEUGEOT	Common Rail Diesel Injector
5WS40000-Z	00001980F0	PEUGEOT	Common Rail Diesel Injector
5WS40008-Z	00001920EP	CITROËN	Diesel Common Rail Pump
5WS40008-Z	9651590880	PEUGEOT	Diesel Common Rail Pump
5WS40008-Z	5WS40008	Continental After-market GmbH	Diesel Common Rail Pump
5WS40008-Z	A2C20000727	Continental After-market GmbH	Diesel Common Rail Pump
5WS40008-Z	1920EP	PEUGEOT	Diesel Common Rail Pump
5WS40008-Z	Y401-13-800B	MAZDA	Diesel Common Rail Pump
5WS40008-Z	2S6Q9A543A	FORD	Diesel Common Rail Pump
5WS40008-Z	1920EP	CITROËN	Diesel Common Rail Pump
5WS40008-Z	00001920EP	PEUGEOT	Diesel Common Rail Pump
5WS40018-Z	00001920CG	CITROËN	Diesel Common Rail Pump
5WS40018-Z	1920CG	CITROËN	Diesel Common Rail Pump
5WS40018-Z	9658195080	CITROËN	Diesel Common Rail Pump
5WS40018-Z	00001920CG	PEUGEOT	Diesel Common Rail Pump
5WS40018-Z	1920CG	PEUGEOT	Diesel Common Rail Pump
5WS40018-Z	9658195080	PEUGEOT	Diesel Common Rail Pump
5WS40018-Z	5WS40018	Continental After-market GmbH	Diesel Common Rail Pump
5WS40018-Z	A2C20000502	Continental After-market GmbH	Diesel Common Rail Pump
5WS40148-Z	00001980E7	CITROËN	Common Rail Diesel Injector
5WS40148-Z	9655304780	CITROËN	Common Rail Diesel Injector
5WS40148-Z	9655304880	CITROËN	Common Rail Diesel Injector

Article-No.	OE-No./Ref.-No.	Manufacturer	Product Name
5WS40148-Z	2S6Q9F593AA	FORD	Common Rail Diesel Injector
5WS40148-Z	2S6Q9F593AB	FORD	Common Rail Diesel Injector
5WS40148-Z	2S6Q9F593AC	FORD	Common Rail Diesel Injector
5WS40148-Z	2S6Q9F593BB	FORD	Common Rail Diesel Injector
5WS40148-Z	00001980E7	PEUGEOT	Common Rail Diesel Injector
5WS40148-Z	1980E7	PEUGEOT	Common Rail Diesel Injector
5WS40148-Z	9655304780	PEUGEOT	Common Rail Diesel Injector
5WS40148-Z	9655304880	PEUGEOT	Common Rail Diesel Injector
5WS40148-Z	5WS40007	Continental After-market GmbH	Common Rail Diesel Injector
5WS40148-Z	5WS40148	Continental After-market GmbH	Common Rail Diesel Injector
5WS40156-4Z	00001980J4	CITROËN	Common Rail Diesel Injector
5WS40156-4Z	1980J4	CITROËN	Common Rail Diesel Injector
5WS40156-4Z	00001980J4	PEUGEOT	Common Rail Diesel Injector
5WS40156-4Z	1980J4	PEUGEOT	Common Rail Diesel Injector
5WS40156-4Z	5WS40156-4	Continental After-market GmbH	Common Rail Diesel Injector
5WS40156-4Z	36000317	VOLVO	Common Rail Diesel Injector
5WS40156-4Z	36000315	VOLVO	Common Rail Diesel Injector
5WS40156-4Z	1373549	FORD	Common Rail Diesel Injector
5WS40156-4Z	9657144680	FIAT	Common Rail Diesel Injector
5WS40156-4Z	3M5Q9F593DB	FORD	Common Rail Diesel Injector
5WS40156-Z	00001980J5	CITROËN	Common Rail Diesel Injector
5WS40156-Z	1980J5	CITROËN	Common Rail Diesel Injector
5WS40156-Z	1373550	FORD	Common Rail Diesel Injector
5WS40156-Z	3M5Q9F593EB	FORD	Common Rail Diesel Injector
5WS40156-Z	00001980J5	PEUGEOT	Common Rail Diesel Injector
5WS40156-Z	1980J5	PEUGEOT	Common Rail Diesel Injector
5WS40156-Z	36000318	VOLVO	Common Rail Diesel Injector
5WS40156-Z	36000319	VOLVO	Common Rail Diesel Injector
5WS40156-Z	5WS40156	Continental After-market GmbH	Common Rail Diesel Injector
5WS40809-Z	00001920QH	CITROËN	Diesel Common Rail Pump
5WS40809-Z	1920QH	CITROËN	Diesel Common Rail Pump



Article-No.	OE-No./Ref.-No.	Manufacturer	Product Name
5WS40809-Z	9688153080	CITROËN	Diesel Common Rail Pump
5WS40809-Z	9681945580	FIAT	Diesel Common Rail Pump
5WS40809-Z	9684704880	FIAT	Diesel Common Rail Pump
5WS40809-Z	1373546	FORD	Diesel Common Rail Pump
5WS40809-Z	3M5Q9A543BD	FORD	Diesel Common Rail Pump
5WS40809-Z	00001920QH	PEUGEOT	Diesel Common Rail Pump
5WS40809-Z	1920QH	PEUGEOT	Diesel Common Rail Pump
5WS40809-Z	9688153080	PEUGEOT	Diesel Common Rail Pump
5WS40809-Z	5WS40809	Continental After-market GmbH	Diesel Common Rail Pump
5WS40809-Z	A2C20000598	Continental After-market GmbH	Diesel Common Rail Pump
A2C1283160085	00001920QH	CITROËN	Diesel Common Rail Pump
A2C1283160085	1920QH	CITROËN	Diesel Common Rail Pump
A2C1283160085	9688153080	CITROËN	Diesel Common Rail Pump
A2C1283160085	9681945580	FIAT	Diesel Common Rail Pump
A2C1283160085	9684704880	FIAT	Diesel Common Rail Pump
A2C1283160085	1373546	FORD	Diesel Common Rail Pump
A2C1283160085	3M5Q-9A543-BD	FORD	Diesel Common Rail Pump
A2C1283160085	00001920QH	PEUGEOT	Diesel Common Rail Pump
A2C1283160085	1920QH	PEUGEOT	Diesel Common Rail Pump
A2C1283160085	9688153080	PEUGEOT	Diesel Common Rail Pump
A2C1283160085	5WS40809-Z	VDO	Diesel Common Rail Pump
A2C1283160085	5WS40809	Continental After-market GmbH	Diesel Common Rail Pump
A2C1283160085	A2C20000598	Continental After-market GmbH	Diesel Common Rail Pump
A2C1283180085	00001920HJ	CITROËN	Diesel Common Rail Pump
A2C1283180085	1920HJ	CITROËN	Diesel Common Rail Pump
A2C1283180085	00001920HJ	PEUGEOT	Diesel Common Rail Pump
A2C1283180085	1920HJ	PEUGEOT	Diesel Common Rail Pump
A2C1283180085	A2C59511314	VDO	Diesel Common Rail Pump
A2C1283180085	LR024834	LAND ROVER	Diesel Common Rail Pump
A2C1283180085	5WS40157	Continental After-market GmbH	Diesel Common Rail Pump
A2C1283180085	A2C20003757	Continental After-market GmbH	Diesel Common Rail Pump

Article-No.	OE-No./Ref.-No.	Manufacturer	Product Name
A2C1283180085	LR009804	LAND ROVER	Diesel Common Rail Pump
A2C1283180085	LR005958	LAND ROVER	Diesel Common Rail Pump
A2C1283180085	02C2S40185	JAGUAR	Diesel Common Rail Pump
A2C1637670080	HG9Q9B395AA	FORD	Diesel Common Rail Pump
A2C1637670080	HG9Q-9B395-AA	FORD	Diesel Common Rail Pump
A2C1637670080	2215504	FORD	Diesel Common Rail Pump
A2C5328876880	1717578	FORD	Distributor Pipe, fuel
A2C5328876880	BK2Q9D280AB	FORD	Distributor Pipe, fuel
A2C5328876880	BK2Q9D280BB	FORD	Distributor Pipe, fuel
A2C5328876880	U21313150	MAZDA	Distributor Pipe, fuel
A2C5328876880	A2C53288768	Continental After-market GmbH	Distributor Pipe, fuel
A2C59507596	A2C53381618	Continental After-market GmbH	Common Rail Diesel Injector
A2C59507596	8201041272	DACIA	Common Rail Diesel Injector
A2C59507596	166006526R	DACIA	Common Rail Diesel Injector
A2C59507596	166006212R	DACIA	Common Rail Diesel Injector
A2C59507596	8201041272	RENAULT	Common Rail Diesel Injector
A2C59507596	166006526R	RENAULT	Common Rail Diesel Injector
A2C59507596	166006212R	RENAULT	Common Rail Diesel Injector
A2C59507608	A 607 070 00 00	MERCEDES-BENZ	Diesel Common Rail Pump
A2C59507608	A 607 070 00 01	MERCEDES-BENZ	Diesel Common Rail Pump
A2C59507608	16 70 036 69R	RENAULT	Diesel Common Rail Pump
A2C59507608	16 70 085 57R	RENAULT	Diesel Common Rail Pump
A2C59507608	16 70 089 97R	RENAULT	Diesel Common Rail Pump
A2C59507608	16 70 036 69R	DACIA	Diesel Common Rail Pump
A2C59507608	16 70 085 57R	DACIA	Diesel Common Rail Pump
A2C59507608	16 70 089 97R	DACIA	Diesel Common Rail Pump
A2C59507608	A2C53351931	Continental After-market GmbH	Diesel Common Rail Pump
A2C59511314	00001920HJ	CITROËN	Diesel Common Rail Pump
A2C59511314	1920HJ	CITROËN	Diesel Common Rail Pump
A2C59511314	02C2S40185	JAGUAR	Diesel Common Rail Pump
A2C59511314	00001920HJ	PEUGEOT	Diesel Common Rail Pump

































Article-No.	OE-No./Ref.-No.	Manufacturer	Product Name
A2C59511314	1920HJ	PEUGEOT	Diesel Common Rail Pump
A2C59511314	LR005958	LAND ROVER	Diesel Common Rail Pump
A2C59511314	LR009804	LAND ROVER	Diesel Common Rail Pump
A2C59511314	LR024834	LAND ROVER	Diesel Common Rail Pump
A2C59511314	5WS40157	Continental After-market GmbH	Diesel Common Rail Pump
A2C59511314	A2C20003757	Continental After-market GmbH	Diesel Common Rail Pump
A2C59511316	00001980H1	CITROËN	Common Rail Diesel Injector
A2C59511316	02C2S40004	JAGUAR	Common Rail Diesel Injector
A2C59511316	1980H1	PEUGEOT	Common Rail Diesel Injector
A2C59511364	4H2Q9K546AF	FORD	Common Rail Diesel Injector
A2C59511364	LR006495	LAND ROVER	Common Rail Diesel Injector
A2C59511364	LR008836	LAND ROVER	Common Rail Diesel Injector
A2C59511600	1541974	FORD	Diesel Common Rail Pump
A2C59511600	3M5Q9A543CD	FORD	Diesel Common Rail Pump
A2C59511600	36002487	VOLVO	Diesel Common Rail Pump
A2C59511600	5WS40380	Continental After-market GmbH	Diesel Common Rail Pump
A2C59511600	A2C27100268	Continental After-market GmbH	Diesel Common Rail Pump
A2C59511601	00001980J6	CITROËN	Common Rail Diesel Injector
A2C59511601	1980J6	CITROËN	Common Rail Diesel Injector
A2C59511601	9657144880	FIAT	Common Rail Diesel Injector
A2C59511601	1483820	FORD	Common Rail Diesel Injector
A2C59511601	3M5Q9F593FB	FORD	Common Rail Diesel Injector
A2C59511601	00001980J6	PEUGEOT	Common Rail Diesel Injector
A2C59511601	1980J6	PEUGEOT	Common Rail Diesel Injector
A2C59511602	00001980K5	CITROËN	Common Rail Diesel Injector
A2C59511602	1980K5	CITROËN	Common Rail Diesel Injector
A2C59511602	9659337980	FIAT	Common Rail Diesel Injector
A2C59511602	00001980K5	PEUGEOT	Common Rail Diesel Injector
A2C59511602	1980K5	PEUGEOT	Common Rail Diesel Injector
A2C59511603	1980K8	CITROËN	Common Rail Diesel Injector
A2C59511603	1980K8	PEUGEOT	Common Rail Diesel Injector

Article-No.	OE-No./Ref.-No.	Manufacturer	Product Name
A2C59511603	9658194180	PEUGEOT	Common Rail Diesel Injector
A2C59511603	1980Z4	PEUGEOT	Common Rail Diesel Injector
A2C59511603	9658194180	CITROËN	Common Rail Diesel Injector
A2C59511603	1980Z4	CITROËN	Common Rail Diesel Injector
A2C59511605	5WS40153	Continental After-market GmbH	Diesel Common Rail Pump
A2C59511605	A2C20000754	Continental After-market GmbH	Diesel Common Rail Pump
A2C59511605	8200821184	RENAULT	Diesel Common Rail Pump
A2C59511605	8200663258	RENAULT	Diesel Common Rail Pump
A2C59511605	8200430599	RENAULT	Diesel Common Rail Pump
A2C59511605	167008859R	RENAULT	Diesel Common Rail Pump
A2C59511605	16700 00Q1L	NISSAN	Diesel Common Rail Pump
A2C59511605	16700 00Q1C	NISSAN	Diesel Common Rail Pump
A2C59511605	16700 00Q0N	NISSAN	Diesel Common Rail Pump
A2C59511606	16600 00Q0H	NISSAN	Common Rail Diesel Injector
A2C59511606	16600 00Q0P	NISSAN	Common Rail Diesel Injector
A2C59511606	16600 00Q1T	NISSAN	Common Rail Diesel Injector
A2C59511606	166009445R	RENAULT	Common Rail Diesel Injector
A2C59511606	8200380253	RENAULT	Common Rail Diesel Injector
A2C59511606	8200842205	RENAULT	Common Rail Diesel Injector
A2C59511609	1543842	FORD	Diesel Common Rail Pump
A2C59511609	5WS40094	Continental After-market GmbH	Diesel Common Rail Pump
A2C59511609	A2C20003032	Continental After-market GmbH	Diesel Common Rail Pump
A2C59511609	4M5Q-9B395-AF	FORD	Diesel Common Rail Pump
A2C59511609	4M5Q-9B395-AE	FORD	Diesel Common Rail Pump
A2C59511609	4M5Q-9B395-AD	FORD	Diesel Common Rail Pump
A2C59511610	1355051	FORD	Common Rail Diesel Injector
A2C59511610	4M5Q9F593AD	FORD	Common Rail Diesel Injector
A2C59511611	1432322	FORD	Common Rail Diesel Injector
A2C59511611	7T1Q9F593AB	FORD	Common Rail Diesel Injector
A2C59511612	00001980L0	CITROËN	Common Rail Diesel Injector
A2C59511612	1980L0	CITROËN	Common Rail Diesel Injector



Article-No.	OE-No./Ref.-No.	Manufacturer	Product Name
A2C59511612	Y404-13-250A	MAZDA	 Common Rail Diesel Injector
A2C59511612	00001980L0	PEUGEOT	 Common Rail Diesel Injector
A2C59511612	1980L0	PEUGEOT	 Common Rail Diesel Injector
A2C59511612	9663429280	PEUGEOT	 Common Rail Diesel Injector
A2C59511612	5WS40149-Z	VDO	 Common Rail Diesel Injector
A2C59511612	5WS40516	Continental After-market GmbH	 Common Rail Diesel Injector
A2C59513481	LR006735	LAND ROVER	 Diesel Common Rail Pump
A2C59513481	LR009737	LAND ROVER	 Diesel Common Rail Pump
A2C59513481	LR010136	LAND ROVER	 Diesel Common Rail Pump
A2C59513481	LR010189	LAND ROVER	 Diesel Common Rail Pump
A2C59513481	5WS40254	Continental After-market GmbH	 Diesel Common Rail Pump
A2C59513481	A2C20003180	Continental After-market GmbH	 Diesel Common Rail Pump
A2C59513481	6H4Q9B395BG	FORD	 Diesel Common Rail Pump
A2C59513482	LR005549	LAND ROVER	 Diesel Common Rail Pump
A2C59513482	LR008831	LAND ROVER	 Diesel Common Rail Pump
A2C59513482	LR009666	LAND ROVER	 Diesel Common Rail Pump
A2C59513482	LR017367	LAND ROVER	 Diesel Common Rail Pump
A2C59513482	LR049606	LAND ROVER	 Diesel Common Rail Pump
A2C59513482	5WS40273	Continental After-market GmbH	 Diesel Common Rail Pump
A2C59513482	A2C20003282	Continental After-market GmbH	 Diesel Common Rail Pump
A2C59513482	7H2Q9B395CH	LAND ROVER	 Diesel Common Rail Pump
A2C59513484	16600 00Q1F	NISSAN	 Common Rail Diesel Injector
A2C59513484	16 60 043 05R	RENAULT	 Common Rail Diesel Injector
A2C59513484	16 60 080 52R	RENAULT	 Common Rail Diesel Injector
A2C59513484	8200903034	RENAULT	 Common Rail Diesel Injector
A2C59513484	16 60 043 05R	DACIA	 Common Rail Diesel Injector
A2C59513484	16 60 080 52R	DACIA	 Common Rail Diesel Injector
A2C59513484	8200903034	DACIA	 Common Rail Diesel Injector
A2C59513553	7H2Q9K546CB	FORD	 Common Rail Diesel Injector
A2C59513553	LR006496	LAND ROVER	 Common Rail Diesel Injector
A2C59513553	LR008837	LAND ROVER	 Common Rail Diesel Injector









Article-No.	OE-No./Ref.-No.	Manufacturer	Product Name
A2C59513556	00001980ER	CITROËN	 Common Rail Diesel Injector
A2C59513556	00001980ET	CITROËN	 Common Rail Diesel Injector
A2C59513556	00001980R9	CITROËN	 Common Rail Diesel Injector
A2C59513556	00001980S0	CITROËN	 Common Rail Diesel Injector
A2C59513556	1980ER	CITROËN	 Common Rail Diesel Injector
A2C59513556	1980ET	CITROËN	 Common Rail Diesel Injector
A2C59513556	1980R9	CITROËN	 Common Rail Diesel Injector
A2C59513556	1980S0	CITROËN	 Common Rail Diesel Injector
A2C59513556	9802448680	CITROËN	 Common Rail Diesel Injector
A2C59513556	1791017	FORD	 Common Rail Diesel Injector
A2C59513556	1812616	FORD	 Common Rail Diesel Injector
A2C59513556	00001980ER	PEUGEOT	 Common Rail Diesel Injector
A2C59513556	00001980ET	PEUGEOT	 Common Rail Diesel Injector
A2C59513556	00001980R9	PEUGEOT	 Common Rail Diesel Injector
A2C59513556	00001980S0	PEUGEOT	 Common Rail Diesel Injector
A2C59513556	1980ER	PEUGEOT	 Common Rail Diesel Injector
A2C59513556	1980ET	PEUGEOT	 Common Rail Diesel Injector
A2C59513556	1980R9	PEUGEOT	 Common Rail Diesel Injector
A2C59513556	1980S0	PEUGEOT	 Common Rail Diesel Injector
A2C59513556	9802448680	PEUGEOT	 Common Rail Diesel Injector
A2C59513556	36001726	VOLVO	 Common Rail Diesel Injector
A2C59513556	36001727	VOLVO	 Common Rail Diesel Injector
A2C59513556	36001728	VOLVO	 Common Rail Diesel Injector
A2C59513556	36001729	VOLVO	 Common Rail Diesel Injector
A2C59513595	16700 00Q1F	NISSAN	 Diesel Common Rail Pump
A2C59513595	16700 00Q1M	NISSAN	 Diesel Common Rail Pump
A2C59513595	16 70 000 61R	RENAULT	 Diesel Common Rail Pump
A2C59513595	16 70 009 38R	RENAULT	 Diesel Common Rail Pump
A2C59513595	8200704200	RENAULT	 Diesel Common Rail Pump
A2C59513595	16 70 000 61R	DACIA	 Diesel Common Rail Pump
A2C59513595	16 70 009 38R	DACIA	 Diesel Common Rail Pump



Article-No.	OE-No./Ref.-No.	Manufacturer	Product Name
A2C59513595	8200704200	DACIA	Diesel Common Rail Pump
A2C59513595	5WS40565	Continental After-market GmbH	Diesel Common Rail Pump
A2C59513595	A2C53252602	Continental After-market GmbH	Diesel Common Rail Pump
A2C59513596	6H4Q9K546DB	LAND ROVER	Common Rail Diesel Injector
A2C59513596	LR0008832	LAND ROVER	Common Rail Diesel Injector
A2C59513596	LR0008834	LAND ROVER	Common Rail Diesel Injector
A2C59513596	LR002473	LAND ROVER	Common Rail Diesel Injector
A2C59513596	LR002475	LAND ROVER	Common Rail Diesel Injector
A2C59513597	6H4Q9K546EB	LAND ROVER	Common Rail Diesel Injector
A2C59513597	LR0008833	LAND ROVER	Common Rail Diesel Injector
A2C59513597	LR0008835	LAND ROVER	Common Rail Diesel Injector
A2C59513597	LR002474	LAND ROVER	Common Rail Diesel Injector
A2C59513597	LR002476	LAND ROVER	Common Rail Diesel Injector
A2C59513829	1720038	FORD	Diesel Common Rail Pump
A2C59513829	1804823	FORD	Diesel Common Rail Pump
A2C59513829	36001730	VOLVO	Diesel Common Rail Pump
A2C59513829	5WS40893	Continental After-market GmbH	Diesel Common Rail Pump
A2C59513829	A2C53384062	Continental After-market GmbH	Diesel Common Rail Pump
A2C59513830	00001920QX	CITROËN	Diesel Common Rail Pump
A2C59513830	00001920RY	CITROËN	Diesel Common Rail Pump
A2C59513830	1920QX	CITROËN	Diesel Common Rail Pump
A2C59513830	1920RY	CITROËN	Diesel Common Rail Pump
A2C59513830	00001920QX	PEUGEOT	Diesel Common Rail Pump
A2C59513830	00001920RY	PEUGEOT	Diesel Common Rail Pump
A2C59513830	1920QX	PEUGEOT	Diesel Common Rail Pump
A2C59513830	1920RY	PEUGEOT	Diesel Common Rail Pump
A2C59513830	5WS40894	Continental After-market GmbH	Diesel Common Rail Pump
A2C59513830	A2C53381555	Continental After-market GmbH	Diesel Common Rail Pump
A2C59517043	1717702	FORD	Diesel Common Rail Pump
A2C59517043	1841728	FORD	Diesel Common Rail Pump
A2C59517043	1849878	FORD	Diesel Common Rail Pump

Article-No.	OE-No./Ref.-No.	Manufacturer	Product Name
A2C59517043	LR029969	LAND ROVER	Diesel Common Rail Pump
A2C59517043	LR052872	LAND ROVER	Diesel Common Rail Pump
A2C59517043	5WS40695	Continental After-market GmbH	Diesel Common Rail Pump
A2C59517043	A2C53344441	Continental After-market GmbH	Diesel Common Rail Pump
A2C59517045	9678171880	CITROËN	Diesel Common Rail Pump
A2C59517045	1731745	FORD	Diesel Common Rail Pump
A2C59517045	1841726	FORD	Diesel Common Rail Pump
A2C59517045	9678171880	PEUGEOT	Diesel Common Rail Pump
A2C59517045	5WS40694	Continental After-market GmbH	Diesel Common Rail Pump
A2C59517045	A2C53344443	Continental After-market GmbH	Diesel Common Rail Pump
A2C59517047	5WS40836	Continental After-market GmbH	Diesel Common Rail Pump
A2C59517047	A2C53341464	Continental After-market GmbH	Diesel Common Rail Pump
A2C59517047	03L 130 755 E	VW	Diesel Common Rail Pump
A2C59517047	03L 130 755 AL	VW	Diesel Common Rail Pump
A2C59517047	03L 130 755 E	SKODA	Diesel Common Rail Pump
A2C59517047	03L 130 755 AL	SKODA	Diesel Common Rail Pump
A2C59517047	03L 130 755 E	SEAT	Diesel Common Rail Pump
A2C59517047	03L 130 755 AL	SEAT	Diesel Common Rail Pump
A2C59517047	03L 130 755 E	AUDI	Diesel Common Rail Pump
A2C59517047	03L 130 755 AL	AUDI	Diesel Common Rail Pump
A2C59517049	03L 130 755 AN	AUDI	Diesel Common Rail Pump
A2C59517049	03L 130 755 AN	SEAT	Diesel Common Rail Pump
A2C59517049	03L 130 755 AN	SKODA	Diesel Common Rail Pump
A2C59517049	03L 130 755 AN	VW	Diesel Common Rail Pump
A2C59517049	5WS40891	Continental After-market GmbH	Diesel Common Rail Pump
A2C59517049	A2C53366731	Continental After-market GmbH	Diesel Common Rail Pump
A2C59517051	9801125480	CITROËN	Common Rail Diesel Injector
A2C59517051	1746967	FORD	Common Rail Diesel Injector
A2C59517051	1840747	FORD	Common Rail Diesel Injector
A2C59517051	BK2Q-9K546-AG	FORD	Common Rail Diesel Injector
A2C59517051	9801125480	PEUGEOT	Common Rail Diesel Injector



Article-No.	OE-No./Ref.-No.	Manufacturer	Product Name
A2C8139490080	1819881	FORD	 Common Rail Diesel Injector
A2C8139490080	CK4Q9K546AA	FORD	 Common Rail Diesel Injector
A2C9321760080	1881202	FORD	 Diesel Common Rail Pump
A2C9321760080	FB3Q9B395AB	FORD	 Diesel Common Rail Pump
A2C9321760080	U203-13-350	MAZDA	 Diesel Common Rail Pump
A2C9626040080	03L 130 277 S	AUDI	 Common Rail Diesel Injector
A2C9626040080	03L 130 277 S	VW	 Common Rail Diesel Injector
A2C9626040080	03L 130 277 S	SKODA	 Common Rail Diesel Injector
A2C9626040080	03L 130 277 S	SEAT	 Common Rail Diesel Injector













Article-No.	OE-No./Ref.-No.	Manufacturer	Product Name
-------------	-----------------	--------------	--------------





















OE-No./Ref.-No.	Manufacturer	Article-No.	Product Name
00001920CG	CITROËN	5WS40018-Z	Diesel Common Rail Pump
00001920CG	PEUGEOT	5WS40018-Z	Diesel Common Rail Pump
00001920EP	CITROËN	5WS40008-Z	Diesel Common Rail Pump
00001920EP	PEUGEOT	5WS40008-Z	Diesel Common Rail Pump
00001920HJ	CITROËN	A2C59511314	Diesel Common Rail Pump
00001920HJ	PEUGEOT	A2C59511314	Diesel Common Rail Pump
00001920HJ	CITROËN	A2C1283180085	Diesel Common Rail Pump
00001920HJ	PEUGEOT	A2C1283180085	Diesel Common Rail Pump
00001920QH	CITROËN	A2C1283160085	Diesel Common Rail Pump
00001920QH	PEUGEOT	A2C1283160085	Diesel Common Rail Pump
00001920QH	CITROËN	5WS40809-Z	Diesel Common Rail Pump
00001920QH	PEUGEOT	5WS40809-Z	Diesel Common Rail Pump
00001920QX	CITROËN	A2C59513830	Diesel Common Rail Pump
00001920QX	PEUGEOT	A2C59513830	Diesel Common Rail Pump
00001920RY	CITROËN	A2C59513830	Diesel Common Rail Pump
00001920RY	PEUGEOT	A2C59513830	Diesel Common Rail Pump
00001980E7	CITROËN	5WS40148-Z	Common Rail Diesel Injector
00001980E7	PEUGEOT	5WS40148-Z	Common Rail Diesel Injector
00001980ER	CITROËN	A2C59513556	Common Rail Diesel Injector
00001980ER	PEUGEOT	A2C59513556	Common Rail Diesel Injector
00001980ET	CITROËN	A2C59513556	Common Rail Diesel Injector
00001980ET	PEUGEOT	A2C59513556	Common Rail Diesel Injector
00001980F0	CITROËN	5WS40000-Z	Common Rail Diesel Injector
00001980F0	PEUGEOT	5WS40000-Z	Common Rail Diesel Injector
00001980H1	CITROËN	A2C59511316	Common Rail Diesel Injector
00001980J4	CITROËN	5WS40156-4Z	Common Rail Diesel Injector
00001980J4	PEUGEOT	5WS40156-4Z	Common Rail Diesel Injector
00001980J5	CITROËN	5WS40156-Z	Common Rail Diesel Injector
00001980J5	PEUGEOT	5WS40156-Z	Common Rail Diesel Injector
00001980J6	CITROËN	A2C59511601	Common Rail Diesel Injector
00001980J6	PEUGEOT	A2C59511601	Common Rail Diesel Injector

OE-No./Ref.-No.	Manufacturer	Article-No.	Product Name
00001980K5	CITROËN	A2C59511602	Common Rail Diesel Injector
00001980K5	PEUGEOT	A2C59511602	Common Rail Diesel Injector
00001980L0	CITROËN	A2C59511612	Common Rail Diesel Injector
00001980L0	PEUGEOT	A2C59511612	Common Rail Diesel Injector
00001980R9	CITROËN	A2C59513556	Common Rail Diesel Injector
00001980R9	PEUGEOT	A2C59513556	Common Rail Diesel Injector
00001980S0	CITROËN	A2C59513556	Common Rail Diesel Injector
00001980S0	PEUGEOT	A2C59513556	Common Rail Diesel Injector
02C2S40004	JAGUAR	A2C59511316	Common Rail Diesel Injector
02C2S40185	JAGUAR	A2C59511314	Diesel Common Rail Pump
02C2S40185	JAGUAR	A2C1283180085	Diesel Common Rail Pump
03L 130 277 S	AUDI	A2C9626040080	Common Rail Diesel Injector
03L 130 277 S	VW	A2C9626040080	Common Rail Diesel Injector
03L 130 277 S	SKODA	A2C9626040080	Common Rail Diesel Injector
03L 130 277 S	SEAT	A2C9626040080	Common Rail Diesel Injector
03L 130 755 AL	VW	A2C59517047	Diesel Common Rail Pump
03L 130 755 AL	SKODA	A2C59517047	Diesel Common Rail Pump
03L 130 755 AL	SEAT	A2C59517047	Diesel Common Rail Pump
03L 130 755 AL	AUDI	A2C59517047	Diesel Common Rail Pump
03L 130 755 AN	AUDI	A2C59517049	Diesel Common Rail Pump
03L 130 755 AN	SEAT	A2C59517049	Diesel Common Rail Pump
03L 130 755 AN	SKODA	A2C59517049	Diesel Common Rail Pump
03L 130 755 AN	VW	A2C59517049	Diesel Common Rail Pump
03L 130 755 E	VW	A2C59517047	Diesel Common Rail Pump
03L 130 755 E	SKODA	A2C59517047	Diesel Common Rail Pump
03L 130 755 E	SEAT	A2C59517047	Diesel Common Rail Pump
03L 130 755 E	AUDI	A2C59517047	Diesel Common Rail Pump
1355051	FORD	A2C59511610	Common Rail Diesel Injector
1373546	FORD	A2C1283160085	Diesel Common Rail Pump
1373546	FORD	5WS40809-Z	Diesel Common Rail Pump
1373549	FORD	5WS40156-4Z	Common Rail Diesel Injector



OE-No./Ref.-No.	Manufacturer	Article-No.	Product Name
1373550	FORD	5WS40156-Z	 Common Rail Diesel Injector
1432322	FORD	A2C59511611	 Common Rail Diesel Injector
1483820	FORD	A2C59511601	 Common Rail Diesel Injector
1541974	FORD	A2C59511600	 Diesel Common Rail Pump
1543842	FORD	A2C59511609	 Diesel Common Rail Pump
16600 00Q0H	NISSAN	A2C59511606	 Common Rail Diesel Injector
16600 00Q0P	NISSAN	A2C59511606	 Common Rail Diesel Injector
16600 00Q1F	NISSAN	A2C59513484	 Common Rail Diesel Injector
16600 00Q1T	NISSAN	A2C59511606	 Common Rail Diesel Injector
16 60 043 05R	RENAULT	A2C59513484	 Common Rail Diesel Injector
16 60 043 05R	DACIA	A2C59513484	 Common Rail Diesel Injector
166006212R	DACIA	A2C59507596	 Common Rail Diesel Injector
166006212R	RENAULT	A2C59507596	 Common Rail Diesel Injector
166006526R	DACIA	A2C59507596	 Common Rail Diesel Injector
166006526R	RENAULT	A2C59507596	 Common Rail Diesel Injector
16 60 080 52R	RENAULT	A2C59513484	 Common Rail Diesel Injector
16 60 080 52R	DACIA	A2C59513484	 Common Rail Diesel Injector
166009445R	RENAULT	A2C59511606	 Common Rail Diesel Injector
16 70 000 61R	RENAULT	A2C59513595	 Diesel Common Rail Pump
16 70 000 61R	DACIA	A2C59513595	 Diesel Common Rail Pump
16700 00Q0N	NISSAN	A2C59511605	 Diesel Common Rail Pump
16700 00Q1C	NISSAN	A2C59511605	 Diesel Common Rail Pump
16700 00Q1F	NISSAN	A2C59513595	 Diesel Common Rail Pump
16700 00Q1L	NISSAN	A2C59511605	 Diesel Common Rail Pump
16700 00Q1M	NISSAN	A2C59513595	 Diesel Common Rail Pump
16 70 009 38R	RENAULT	A2C59513595	 Diesel Common Rail Pump
16 70 009 38R	DACIA	A2C59513595	 Diesel Common Rail Pump
16 70 036 69R	RENAULT	A2C59507608	 Diesel Common Rail Pump
16 70 036 69R	DACIA	A2C59507608	 Diesel Common Rail Pump
16 70 085 57R	RENAULT	A2C59507608	 Diesel Common Rail Pump
16 70 085 57R	DACIA	A2C59507608	 Diesel Common Rail Pump

OE-No./Ref.-No.	Manufacturer	Article-No.	Product Name
167008859R	RENAULT	A2C59511605	 Diesel Common Rail Pump
16 70 089 97R	RENAULT	A2C59507608	 Diesel Common Rail Pump
16 70 089 97R	DACIA	A2C59507608	 Diesel Common Rail Pump
1717578	FORD	A2C5328876880	Distributor Pipe, fuel
1717702	FORD	A2C59517043	 Diesel Common Rail Pump
1720038	FORD	A2C59513829	 Diesel Common Rail Pump
1731745	FORD	A2C59517045	 Diesel Common Rail Pump
1746967	FORD	A2C59517051	 Common Rail Diesel Injector
1791017	FORD	A2C59513556	 Common Rail Diesel Injector
1804823	FORD	A2C59513829	 Diesel Common Rail Pump
1812616	FORD	A2C59513556	 Common Rail Diesel Injector
1819881	FORD	A2C8139490080	 Common Rail Diesel Injector
1840747	FORD	A2C59517051	 Common Rail Diesel Injector
1841726	FORD	A2C59517045	 Diesel Common Rail Pump
1841728	FORD	A2C59517043	 Diesel Common Rail Pump
1849878	FORD	A2C59517043	 Diesel Common Rail Pump
1881202	FORD	A2C9321760080	 Diesel Common Rail Pump
1920CG	CITROËN	5WS40018-Z	 Diesel Common Rail Pump
1920CG	PEUGEOT	5WS40018-Z	 Diesel Common Rail Pump
1920EP	PEUGEOT	5WS40008-Z	 Diesel Common Rail Pump
1920EP	CITROËN	5WS40008-Z	 Diesel Common Rail Pump
1920HJ	CITROËN	A2C59511314	 Diesel Common Rail Pump
1920HJ	PEUGEOT	A2C59511314	 Diesel Common Rail Pump
1920HJ	CITROËN	A2C1283180085	 Diesel Common Rail Pump
1920HJ	PEUGEOT	A2C1283180085	 Diesel Common Rail Pump
1920QH	CITROËN	A2C1283160085	 Diesel Common Rail Pump
1920QH	PEUGEOT	A2C1283160085	 Diesel Common Rail Pump
1920QH	CITROËN	5WS40809-Z	 Diesel Common Rail Pump
1920QH	PEUGEOT	5WS40809-Z	 Diesel Common Rail Pump
1920QX	CITROËN	A2C59513830	 Diesel Common Rail Pump
1920QX	PEUGEOT	A2C59513830	 Diesel Common Rail Pump



Cross Reference List OE No. → Art.-No.

OE-No./Ref.-No.	Manufacturer	Article-No.	Product Name
1920RY	CITROËN	A2C59513830	Diesel Common Rail Pump
1920RY	PEUGEOT	A2C59513830	Diesel Common Rail Pump
1980E7	PEUGEOT	5WS40148-Z	Common Rail Diesel Injector
1980ER	CITROËN	A2C59513556	Common Rail Diesel Injector
1980ER	PEUGEOT	A2C59513556	Common Rail Diesel Injector
1980ET	CITROËN	A2C59513556	Common Rail Diesel Injector
1980ET	PEUGEOT	A2C59513556	Common Rail Diesel Injector
1980F0	CITROËN	5WS40000-Z	Common Rail Diesel Injector
1980F0	PEUGEOT	5WS40000-Z	Common Rail Diesel Injector
1980H1	PEUGEOT	A2C59511316	Common Rail Diesel Injector
1980J4	CITROËN	5WS40156-4Z	Common Rail Diesel Injector
1980J4	PEUGEOT	5WS40156-4Z	Common Rail Diesel Injector
1980J5	CITROËN	5WS40156-Z	Common Rail Diesel Injector
1980J5	PEUGEOT	5WS40156-Z	Common Rail Diesel Injector
1980J6	CITROËN	A2C59511601	Common Rail Diesel Injector
1980J6	PEUGEOT	A2C59511601	Common Rail Diesel Injector
1980K5	CITROËN	A2C59511602	Common Rail Diesel Injector
1980K5	PEUGEOT	A2C59511602	Common Rail Diesel Injector
1980K8	CITROËN	A2C59511603	Common Rail Diesel Injector
1980K8	PEUGEOT	A2C59511603	Common Rail Diesel Injector
1980L0	CITROËN	A2C59511612	Common Rail Diesel Injector
1980L0	PEUGEOT	A2C59511612	Common Rail Diesel Injector
1980R9	CITROËN	A2C59513556	Common Rail Diesel Injector
1980R9	PEUGEOT	A2C59513556	Common Rail Diesel Injector
1980S0	CITROËN	A2C59513556	Common Rail Diesel Injector
1980S0	PEUGEOT	A2C59513556	Common Rail Diesel Injector
1980Z4	PEUGEOT	A2C59511603	Common Rail Diesel Injector
1980Z4	CITROËN	A2C59511603	Common Rail Diesel Injector
2215504	FORD	A2C1637670080	Diesel Common Rail Pump
2S6Q9A543A	FORD	5WS40008-Z	Diesel Common Rail Pump
2S6Q9F593AA	FORD	5WS40148-Z	Common Rail Diesel Injector

OE-No./Ref.-No.	Manufacturer	Article-No.	Product Name
2S6Q9F593AB	FORD	5WS40148-Z	Common Rail Diesel Injector
2S6Q9F593AC	FORD	5WS40148-Z	Common Rail Diesel Injector
2S6Q9F593BB	FORD	5WS40148-Z	Common Rail Diesel Injector
36000315	VOLVO	5WS40156-4Z	Common Rail Diesel Injector
36000317	VOLVO	5WS40156-4Z	Common Rail Diesel Injector
36000318	VOLVO	5WS40156-Z	Common Rail Diesel Injector
36000319	VOLVO	5WS40156-Z	Common Rail Diesel Injector
36001726	VOLVO	A2C59513556	Common Rail Diesel Injector
36001727	VOLVO	A2C59513556	Common Rail Diesel Injector
36001728	VOLVO	A2C59513556	Common Rail Diesel Injector
36001729	VOLVO	A2C59513556	Common Rail Diesel Injector
36001730	VOLVO	A2C59513829	Diesel Common Rail Pump
36002487	VOLVO	A2C59511600	Diesel Common Rail Pump
3M5Q9A543BD	FORD	5WS40809-Z	Diesel Common Rail Pump
3M5Q-9A543-BD	FORD	A2C1283160085	Diesel Common Rail Pump
3M5Q9A543CD	FORD	A2C59511600	Diesel Common Rail Pump
3M5Q9F593DB	FORD	5WS40156-4Z	Common Rail Diesel Injector
3M5Q9F593EB	FORD	5WS40156-Z	Common Rail Diesel Injector
3M5Q9F593FB	FORD	A2C59511601	Common Rail Diesel Injector
4H2Q9K546AF	FORD	A2C59511364	Common Rail Diesel Injector
4M5Q-9B395-AD	FORD	A2C59511609	Diesel Common Rail Pump
4M5Q-9B395-AE	FORD	A2C59511609	Diesel Common Rail Pump
4M5Q-9B395-AF	FORD	A2C59511609	Diesel Common Rail Pump
4M5Q9F593AD	FORD	A2C59511610	Common Rail Diesel Injector
5WS40000	Continental Aftermarket GmbH	5WS40000-Z	Common Rail Diesel Injector
5WS40007	Continental Aftermarket GmbH	5WS40148-Z	Common Rail Diesel Injector
5WS40008	Continental Aftermarket GmbH	5WS40008-Z	Diesel Common Rail Pump
5WS40018	Continental Aftermarket GmbH	5WS40018-Z	Diesel Common Rail Pump
5WS40094	Continental Aftermarket GmbH	A2C59511609	Diesel Common Rail Pump
5WS40148	Continental Aftermarket GmbH	5WS40148-Z	Common Rail Diesel Injector
5WS40149-Z	VDO	A2C59511612	Common Rail Diesel Injector



OE-No./Ref.-No.	Manufacturer	Article-No.	Product Name
5WS40153	Continental After-market GmbH	A2C59511605	Diesel Common Rail Pump
5WS40156	Continental After-market GmbH	5WS40156-Z	Common Rail Diesel Injector
5WS40156-4	Continental After-market GmbH	5WS40156-4Z	Common Rail Diesel Injector
5WS40157	Continental After-market GmbH	A2C59511314	Diesel Common Rail Pump
5WS40157	Continental After-market GmbH	A2C1283180085	Diesel Common Rail Pump
5WS40254	Continental After-market GmbH	A2C59513481	Diesel Common Rail Pump
5WS40273	Continental After-market GmbH	A2C59513482	Diesel Common Rail Pump
5WS40380	Continental After-market GmbH	A2C59511600	Diesel Common Rail Pump
5WS40516	Continental After-market GmbH	A2C59511612	Common Rail Diesel Injector
5WS40565	Continental After-market GmbH	A2C59513595	Diesel Common Rail Pump
5WS40694	Continental After-market GmbH	A2C59517045	Diesel Common Rail Pump
5WS40695	Continental After-market GmbH	A2C59517043	Diesel Common Rail Pump
5WS40809	Continental After-market GmbH	A2C1283160085	Diesel Common Rail Pump
5WS40809	Continental After-market GmbH	5WS40809-Z	Diesel Common Rail Pump
5WS40809-Z	VDO	A2C1283160085	Diesel Common Rail Pump
5WS40836	Continental After-market GmbH	A2C59517047	Diesel Common Rail Pump
5WS40891	Continental After-market GmbH	A2C59517049	Diesel Common Rail Pump
5WS40893	Continental After-market GmbH	A2C59513829	Diesel Common Rail Pump
5WS40894	Continental After-market GmbH	A2C59513830	Diesel Common Rail Pump
6H4Q9B395BG	FORD	A2C59513481	Diesel Common Rail Pump
6H4Q9K546DB	LAND ROVER	A2C59513596	Common Rail Diesel Injector
6H4Q9K546EB	LAND ROVER	A2C59513597	Common Rail Diesel Injector
7H2Q9B395CH	LAND ROVER	A2C59513482	Diesel Common Rail Pump
7H2Q9K546CB	FORD	A2C59513553	Common Rail Diesel Injector
7T1Q9F593AB	FORD	A2C59511611	Common Rail Diesel Injector
8200380253	RENAULT	A2C59511606	Common Rail Diesel Injector
8200430599	RENAULT	A2C59511605	Diesel Common Rail Pump
8200663258	RENAULT	A2C59511605	Diesel Common Rail Pump
8200704200	RENAULT	A2C59513595	Diesel Common Rail Pump
8200704200	DACIA	A2C59513595	Diesel Common Rail Pump
8200821184	RENAULT	A2C59511605	Diesel Common Rail Pump

OE-No./Ref.-No.	Manufacturer	Article-No.	Product Name
8200842205	RENAULT	A2C59511606	Common Rail Diesel Injector
8200903034	RENAULT	A2C59513484	Common Rail Diesel Injector
8200903034	DACIA	A2C59513484	Common Rail Diesel Injector
8201041272	DACIA	A2C59507596	Common Rail Diesel Injector
8201041272	RENAULT	A2C59507596	Common Rail Diesel Injector
9651590880	PEUGEOT	5WS40008-Z	Diesel Common Rail Pump
9652173780	CITROËN	5WS40000-Z	Common Rail Diesel Injector
9652173780	PEUGEOT	5WS40000-Z	Common Rail Diesel Injector
9655304780	CITROËN	5WS40148-Z	Common Rail Diesel Injector
9655304780	PEUGEOT	5WS40148-Z	Common Rail Diesel Injector
9655304880	CITROËN	5WS40148-Z	Common Rail Diesel Injector
9655304880	PEUGEOT	5WS40148-Z	Common Rail Diesel Injector
9657144680	FIAT	5WS40156-4Z	Common Rail Diesel Injector
9657144880	FIAT	A2C59511601	Common Rail Diesel Injector
9658194180	PEUGEOT	A2C59511603	Common Rail Diesel Injector
9658194180	CITROËN	A2C59511603	Common Rail Diesel Injector
9658195080	CITROËN	5WS40018-Z	Diesel Common Rail Pump
9658195080	PEUGEOT	5WS40018-Z	Diesel Common Rail Pump
9659337980	FIAT	A2C59511602	Common Rail Diesel Injector
9663429280	PEUGEOT	A2C59511612	Common Rail Diesel Injector
9678171880	CITROËN	A2C59517045	Diesel Common Rail Pump
9678171880	PEUGEOT	A2C59517045	Diesel Common Rail Pump
9681945580	FIAT	A2C1283160085	Diesel Common Rail Pump
9681945580	FIAT	5WS40809-Z	Diesel Common Rail Pump
9684704880	FIAT	A2C1283160085	Diesel Common Rail Pump
9684704880	FIAT	5WS40809-Z	Diesel Common Rail Pump
9688153080	CITROËN	A2C1283160085	Diesel Common Rail Pump
9688153080	PEUGEOT	A2C1283160085	Diesel Common Rail Pump
9688153080	CITROËN	5WS40809-Z	Diesel Common Rail Pump
9688153080	PEUGEOT	5WS40809-Z	Diesel Common Rail Pump
9801125480	CITROËN	A2C59517051	Common Rail Diesel Injector











Cross Reference List OE No. → Art.-No.

OE-No./Ref.-No.	Manufacturer	Article-No.	Product Name
9801125480	PEUGEOT	A2C59517051	Common Rail Diesel Injector
9802448680	CITROËN	A2C59513556	Common Rail Diesel Injector
9802448680	PEUGEOT	A2C59513556	Common Rail Diesel Injector
A2C20000502	Continental After-market GmbH	5WS40018-Z	Diesel Common Rail Pump
A2C20000598	Continental After-market GmbH	A2C1283160085	Diesel Common Rail Pump
A2C20000598	Continental After-market GmbH	5WS40809-Z	Diesel Common Rail Pump
A2C20000727	Continental After-market GmbH	5WS40008-Z	Diesel Common Rail Pump
A2C20000754	Continental After-market GmbH	A2C59511605	Diesel Common Rail Pump
A2C20003032	Continental After-market GmbH	A2C59511609	Diesel Common Rail Pump
A2C20003180	Continental After-market GmbH	A2C59513481	Diesel Common Rail Pump
A2C20003282	Continental After-market GmbH	A2C59513482	Diesel Common Rail Pump
A2C20003757	Continental After-market GmbH	A2C59511314	Diesel Common Rail Pump
A2C20003757	Continental After-market GmbH	A2C1283180085	Diesel Common Rail Pump
A2C27100268	Continental After-market GmbH	A2C59511600	Diesel Common Rail Pump
A2C33349400	Continental After-market GmbH	2910000177400	Common Rail Diesel Injector
A2C53252602	Continental After-market GmbH	A2C59513595	Diesel Common Rail Pump
A2C53288768	Continental After-market GmbH	A2C5328876880	Distributor Pipe, fuel
A2C53341464	Continental After-market GmbH	A2C59517047	Diesel Common Rail Pump
A2C53344441	Continental After-market GmbH	A2C59517043	Diesel Common Rail Pump
A2C53344443	Continental After-market GmbH	A2C59517045	Diesel Common Rail Pump
A2C53351931	Continental After-market GmbH	A2C59507608	Diesel Common Rail Pump
A2C53366731	Continental After-market GmbH	A2C59517049	Diesel Common Rail Pump
A2C53381555	Continental After-market GmbH	A2C59513830	Diesel Common Rail Pump
A2C53381618	Continental After-market GmbH	A2C59507596	Common Rail Diesel Injector
A2C53384062	Continental After-market GmbH	A2C59513829	Diesel Common Rail Pump
A2C53421318	Continental After-market GmbH	2910000177400	Common Rail Diesel Injector
A2C59511314	VDO	A2C1283180085	Diesel Common Rail Pump
A 607 070 00 00	MERCEDES-BENZ	A2C59507608	Diesel Common Rail Pump
A 607 070 00 01	MERCEDES-BENZ	A2C59507608	Diesel Common Rail Pump
BH1Q-9K546-AB	LAND ROVER	2910000177400	Common Rail Diesel Injector
BK2Q9D280AB	FORD	A2C5328876880	Distributor Pipe, fuel

OE-No./Ref.-No.	Manufacturer	Article-No.	Product Name
BK2Q9D280BB	FORD	A2C5328876880	Distributor Pipe, fuel
BK2Q-9K546-AG	FORD	A2C59517051	Common Rail Diesel Injector
CK4Q9K546AA	FORD	A2C8139490080	Common Rail Diesel Injector
FB3Q9B395AB	FORD	A2C9321760080	Diesel Common Rail Pump
HG9Q9B395AA	FORD	A2C1637670080	Diesel Common Rail Pump
HG9Q-9B395-AA	FORD	A2C1637670080	Diesel Common Rail Pump
LR0008832	LAND ROVER	A2C59513596	Common Rail Diesel Injector
LR0008833	LAND ROVER	A2C59513597	Common Rail Diesel Injector
LR0008834	LAND ROVER	A2C59513596	Common Rail Diesel Injector
LR0008835	LAND ROVER	A2C59513597	Common Rail Diesel Injector
LR002473	LAND ROVER	A2C59513596	Common Rail Diesel Injector
LR002474	LAND ROVER	A2C59513597	Common Rail Diesel Injector
LR002475	LAND ROVER	A2C59513596	Common Rail Diesel Injector
LR002476	LAND ROVER	A2C59513597	Common Rail Diesel Injector
LR005549	LAND ROVER	A2C59513482	Diesel Common Rail Pump
LR005958	LAND ROVER	A2C59511314	Diesel Common Rail Pump
LR005958	LAND ROVER	A2C1283180085	Diesel Common Rail Pump
LR006495	LAND ROVER	A2C59511364	Common Rail Diesel Injector
LR006496	LAND ROVER	A2C59513553	Common Rail Diesel Injector
LR006735	LAND ROVER	A2C59513481	Diesel Common Rail Pump
LR008831	LAND ROVER	A2C59513482	Diesel Common Rail Pump
LR008836	LAND ROVER	A2C59511364	Common Rail Diesel Injector
LR008837	LAND ROVER	A2C59513553	Common Rail Diesel Injector
LR009666	LAND ROVER	A2C59513482	Diesel Common Rail Pump
LR009737	LAND ROVER	A2C59513481	Diesel Common Rail Pump
LR009804	LAND ROVER	A2C59511314	Diesel Common Rail Pump
LR009804	LAND ROVER	A2C1283180085	Diesel Common Rail Pump
LR010136	LAND ROVER	A2C59513481	Diesel Common Rail Pump
LR010189	LAND ROVER	A2C59513481	Diesel Common Rail Pump
LR017367	LAND ROVER	A2C59513482	Diesel Common Rail Pump
LR024834	LAND ROVER	A2C59511314	Diesel Common Rail Pump



OE-No./Ref.-No.	Manufacturer	Article-No.	Product Name
LR024834	LAND ROVER	A2C1283180085	 Diesel Common Rail Pump
LR029969	LAND ROVER	A2C59517043	 Diesel Common Rail Pump
LR032067	LAND ROVER	2910000177400	 Common Rail Diesel Injector
LR049606	LAND ROVER	A2C59513482	 Diesel Common Rail Pump
LR052872	LAND ROVER	A2C59517043	 Diesel Common Rail Pump
U203-13-350	MAZDA	A2C9321760080	 Diesel Common Rail Pump
U21313150	MAZDA	A2C5328876880	Distributor Pipe, fuel
Y401-13-800B	MAZDA	5WS40008-Z	 Diesel Common Rail Pump
Y404-13-250A	MAZDA	A2C59511612	 Common Rail Diesel Injector

OE-No./Ref.-No.	Manufacturer	Article-No.	Product Name
-----------------	--------------	-------------	--------------

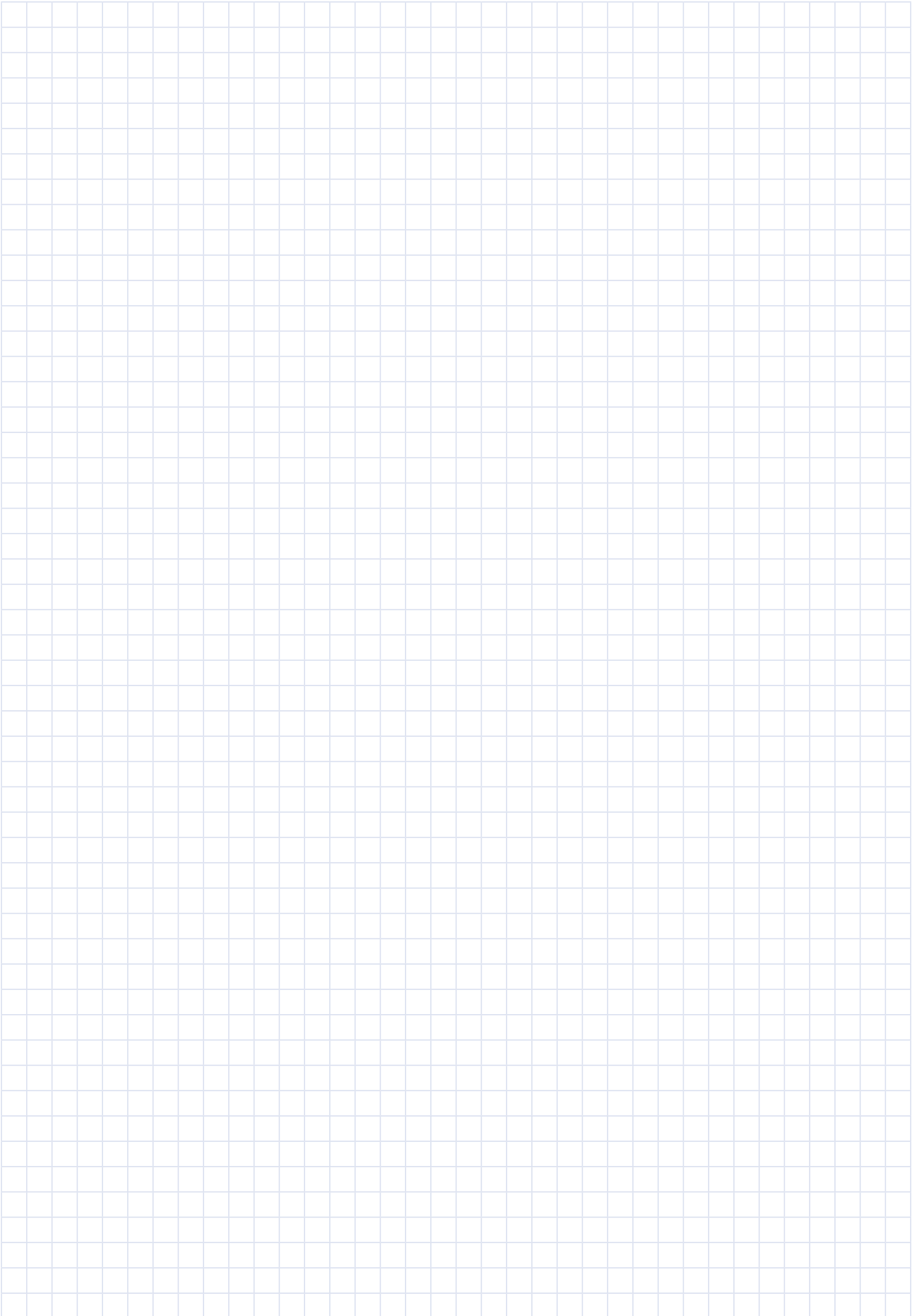

EN	
	Construction year from
	Construction year to
	Chassis number from
	Chassis number to
	Engine Code
	Colour
	Fuel Type
	Common Rail Diesel Injector
	Diesel Common Rail Pump
(C2)	Version
(C3)	Specification
(C11)	for PR number
(C20)	Model year from
(C21)	Model year to
(C27)	Observe the vehicle manufacturer specifications
(C28)	Production date from
(C29)	Production date to
(C31)	Part number of recommended accessories
(C57)	RPO number from
(C61)	for OE number
(C62)	Fuel Mixture Formation
(C68)	for article number
(C106)	Supplementary Article/Info 2
(C121)	Service exchange part
(V52)	Black
(V65)	Diesel
(V178)	with sensor
T019	Have to be taught/updated.
T024	Mandatory - check new part against old part (in particular OE No.)

EN	
T041	Please note the classification of the injector (4, 5 or 6).



DE	
	Baujahr ab
	Baujahr bis
	Fahrgestellnummer ab
	Fahrgestellnummer bis
	Motorcode
	Farbe
	Kraftstoffart
	Common Rail Diesel Injektor
	Diesel Common Rail Pumpe
(C2)	Version
(C3)	Spezifikation
(C11)	für PR-Nummer
(C20)	Modelljahr ab
(C21)	Modelljahr bis
(C27)	Vorgaben des Fahrzeugherstellers beachten
(C28)	Produktionsdatum ab
(C29)	Produktionsdatum bis
(C31)	Artikelnummer des empfohlenen Zubehörs
(C57)	Organisationsnummer ab
(C61)	für OE-Nummer
(C62)	Kraftstoffaufbereitung
(C68)	für Artikelnummer
(C106)	Ergänzungsartikel/Ergänzende Info 2
(C121)	Austauschteil
(V52)	schwarz
(V65)	Diesel
(V178)	mit Sensor
T019	Muß angelernt/aktualisiert werden.
T024	Zwingend Alt- mit Neuteil abgleichen (insbesondere OE-Nr.)

DE	
T041	Bitte Klassifizierung des Injektors beachten (4, 5, 6, 7 oder M).



FR	
	Année à partir de
	Année jusqu'à
	N° de châssis à partir de
	N° de châssis jusqu'à
	Code moteur
	Couleur
	Type de carburant
	Injecteur diesel common rail
	Pompe diesel common rail
(C2)	Version
(C3)	Spécification
(C11)	pour numéro PR
(C20)	Année à partir de
(C21)	Année jusqu'à
(C27)	Attention aux indications du constructeurs du véhicule
(C28)	Date de production à partir de
(C29)	Date de production jusqu'à
(C31)	Référence de l'accessoire recommandé
(C57)	N° d'organisation à partir de
(C61)	pour numéro OE
(C62)	Préparation de carburant
(C68)	pour référence
(C106)	Article complémentaire / Info complémentaire 2
(C121)	Echange standard
(V52)	noir
(V65)	Diesel
(V178)	avec capteur
T019	Doit être adapté/ actualisé.
T024	Vérifier impérativement que l'ancienne pièce et la neuve sont identiques (en particulier n° OE)

FR	
T041	Merci de tenir compte de la classification de l'injecteur (4, 5, 6, 7 ou M).

ES	
	año construcción desde
	año construcción hasta
	nº de chasis desde
	nº de chasis hasta
	Código de motor
	Pintura
	Tipo de combustible
	Inyectore diésel para sistemas Common Rail
	Bomba diésel para sistemas Common Rail
(C2)	Versión
(C3)	Especificación
(C11)	Número de PR
(C20)	año modelo desde
(C21)	año modelo hasta
(C27)	Observar las indicaciones del constructor
(C28)	fecha de producción desde
(C29)	fecha de producción hasta
(C31)	Nº art. de accesorio recomendado
(C57)	nº de organización desde
(C61)	para OE N°
(C62)	Preparación del combustible
(C68)	para artículo nr.
(C106)	Artículo complementario / información complementaria 2
(C121)	Pieza de intercambio
(V52)	negro
(V65)	Gasóleo
(V178)	con sensor
T019	En caso deberá instruirse/actualizarse.
T024	Es obligatorio comparar la pieza vieja con la nueva (en particular el n.º de equipamiento original (OE))

ES	
T041	Rogamos que tengan en cuenta la clasificación del inyector (4, 5, 6, 7 o M).



IT	
	Anno da
	Anno fino a
	N° telaio da
	N° telaio fino a
	Codice motore
	Colore
	Tipo carburante
	Iniettor diesel common rail
	Pompe diesel common rail
(C2)	Versione
(C3)	Specificazione
(C11)	per N° PR
(C20)	Anno modello da
(C21)	Anno modello fino a
(C27)	Osservare direttive costruttore veicolo
(C28)	Data di produzione da
(C29)	Data di produzione fino a
(C31)	N° articolo accessorio consigliato
(C57)	N° organizzazione da
(C61)	per N° OE
(C62)	Preparazione carburante
(C68)	per n° articolo
(C106)	Articolo complementare/Info integrativa 2
(C121)	Ricambio di rotazione
(V52)	nero
(V65)	Diesel
(V178)	con sensore
T019	Necessita di un training/aggiornamento.
T024	È obbligatorio comparare il pezzo vecchio con quello nuovo (in particolare il no. OE)

IT	
T041	Si prega di osservare la classifica dell'iniettore (4, 5, 6,7 o M).



RU	
	Год выпуска с
	Год выпуска до
	Номер шасси с
	Номер шасси до
	Код двигателя
	Цвет
	Вид топлива
	Форсунки для систем впрыска с общим нагнетательным трубопроводом типа Common Rail
	Насосы для систем впрыска с общим нагнетательным трубопроводом типа Common Rail
(C2)	Версия
(C3)	Спецификация
(C11)	для заменяемого номера
(C20)	Модельный год от
(C21)	Модельный год до
(C27)	Обратить внимание на заданные величины производителя трансп.
(C28)	Дата производства от
(C29)	Дата производства до
(C31)	Номера артикулов рекомендуемых комплектующих
(C57)	Организационный номер от
(C61)	для оригинального номера
(C62)	Подготовка топлива
(C68)	для артикула №
(C106)	Дополнительный артикул / дополнительная информация 2
(C121)	Заменяемая часть
(V52)	черный
(V65)	Дизельное топливо
(V178)	с датчиком
T019	Необходимо обучение/ актуализация.

RU	
T024	Обязательно сравнивать старую и новую детали (в частности, номер OE)
T041	Пожалуйста, учитывайте классификацию инжектора (4, 5, 6, 7 или M).

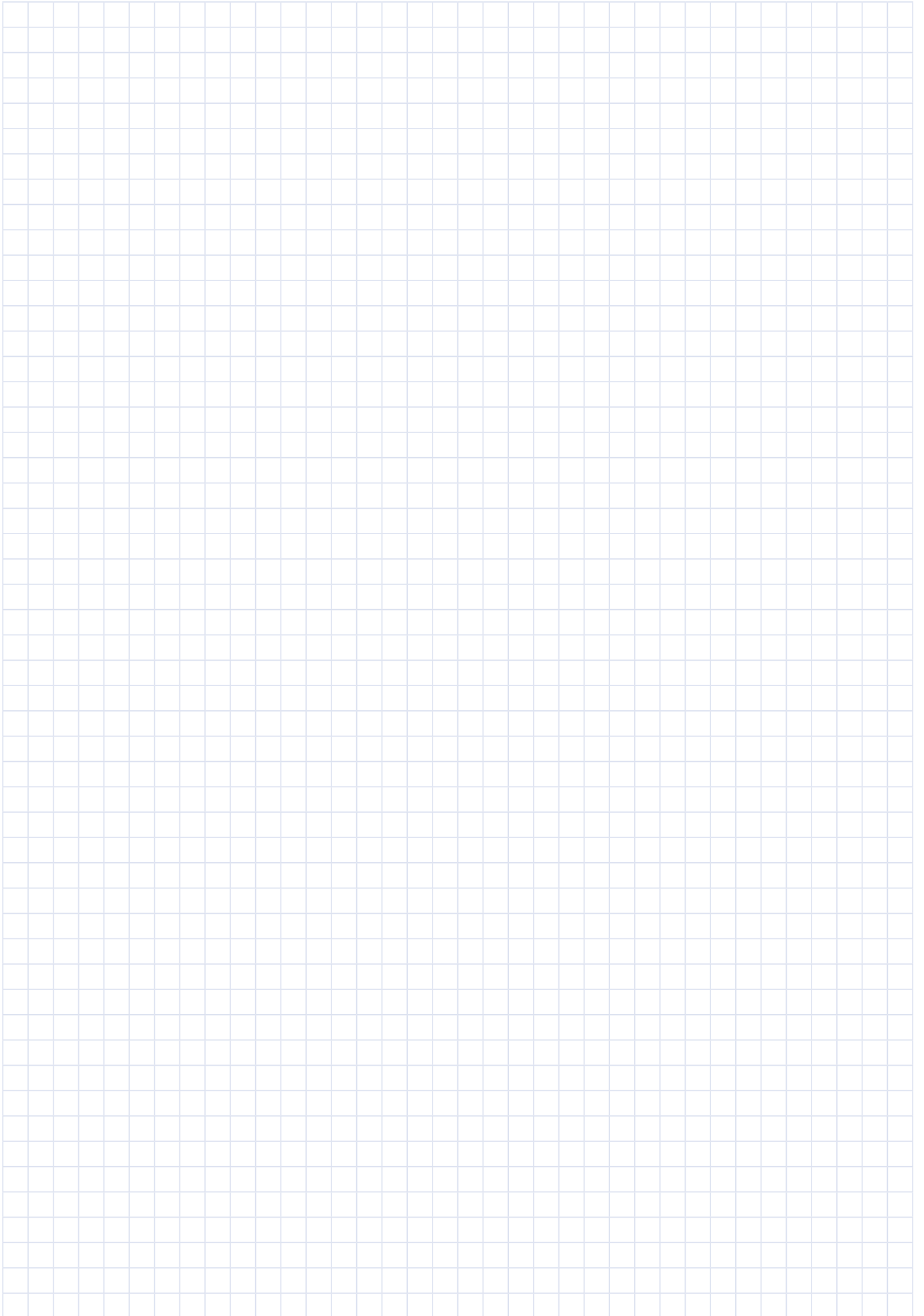

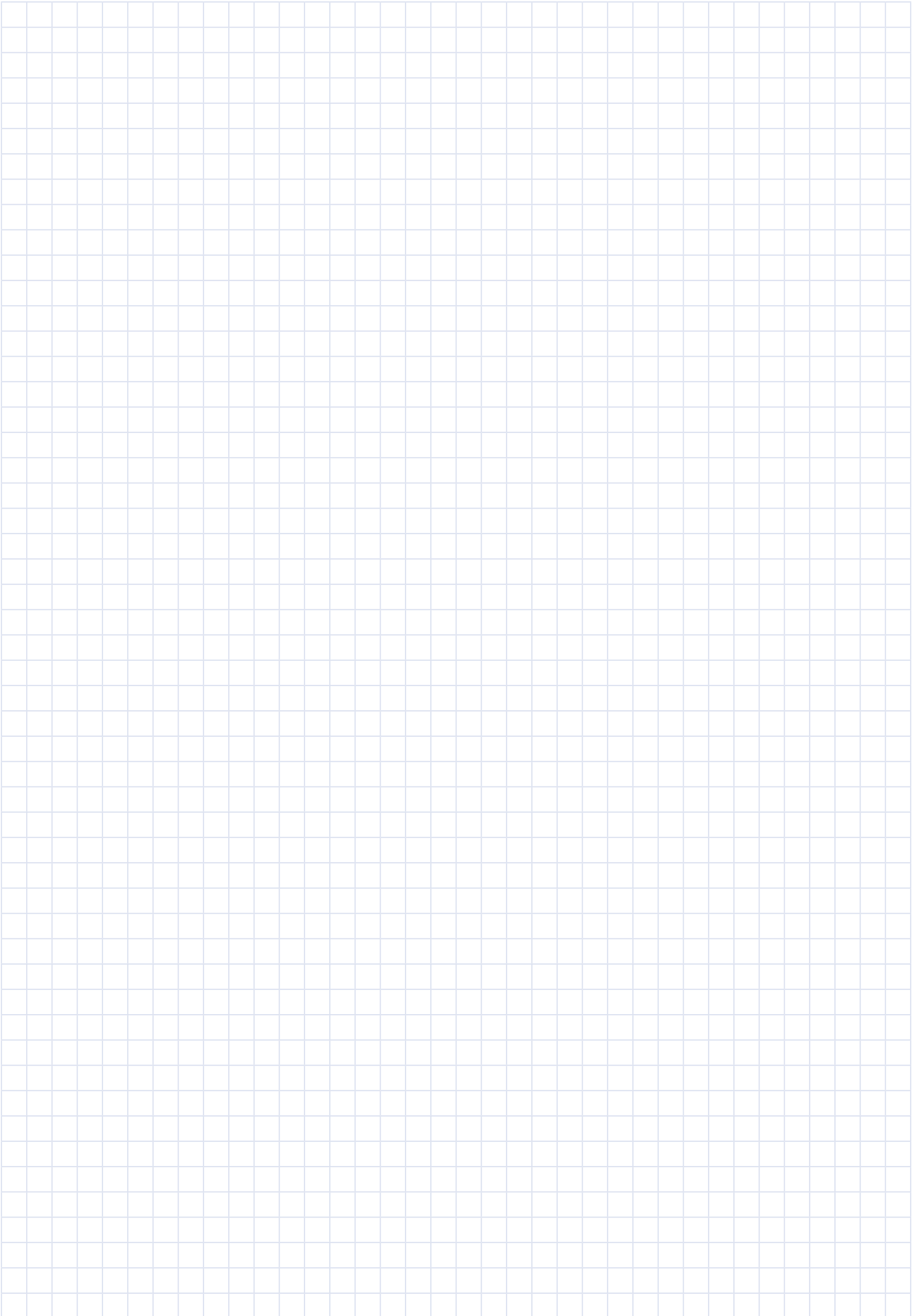

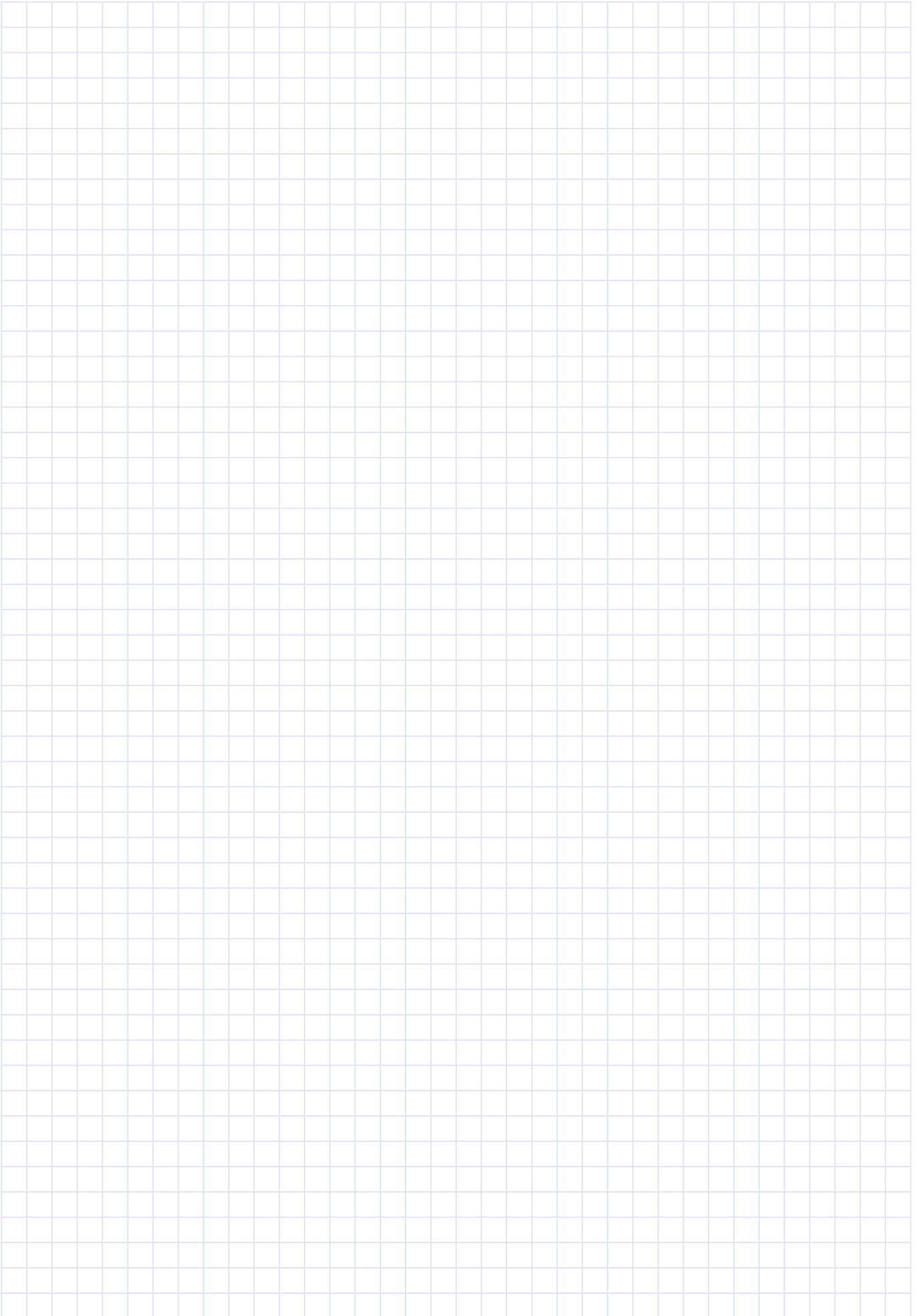

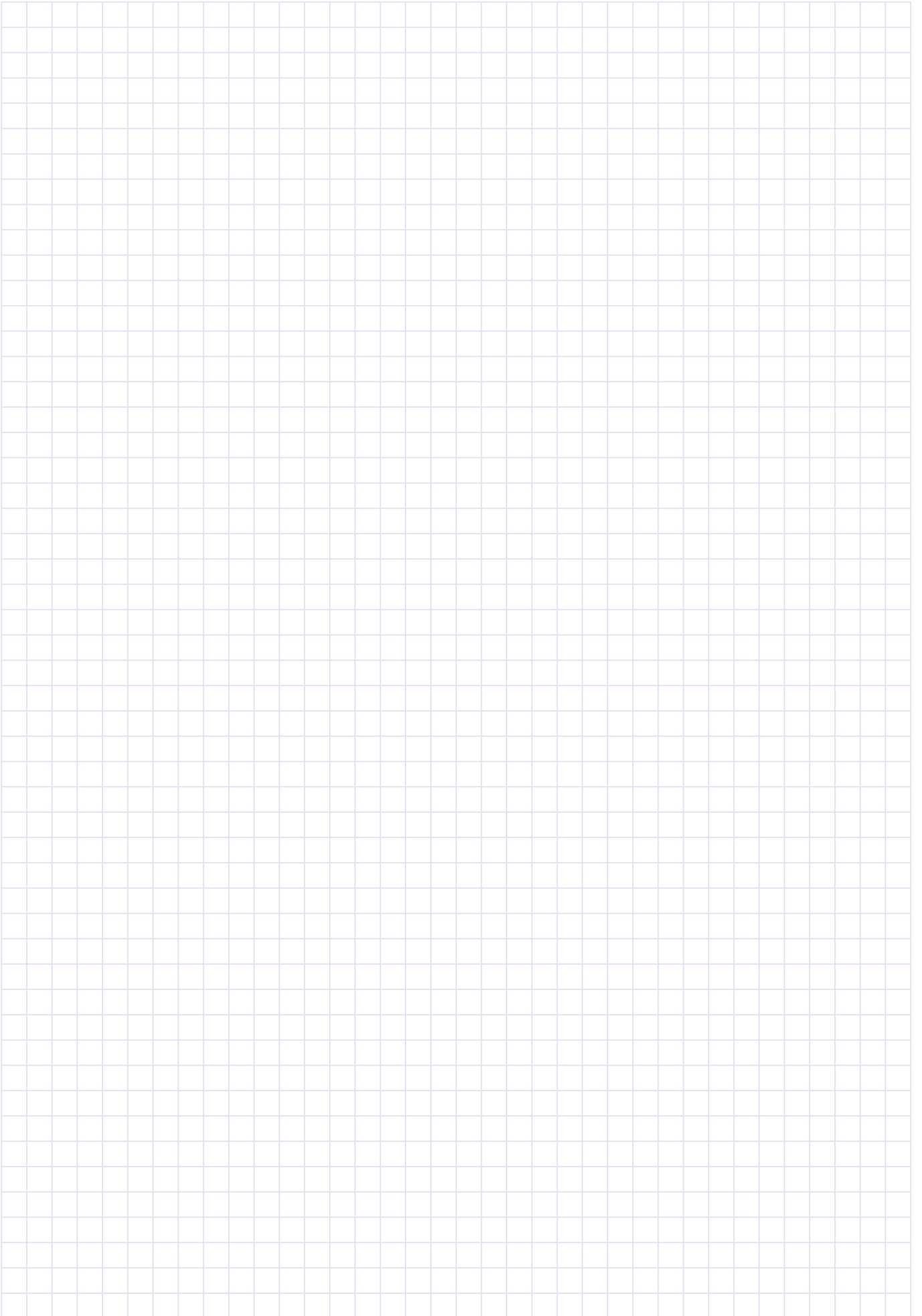

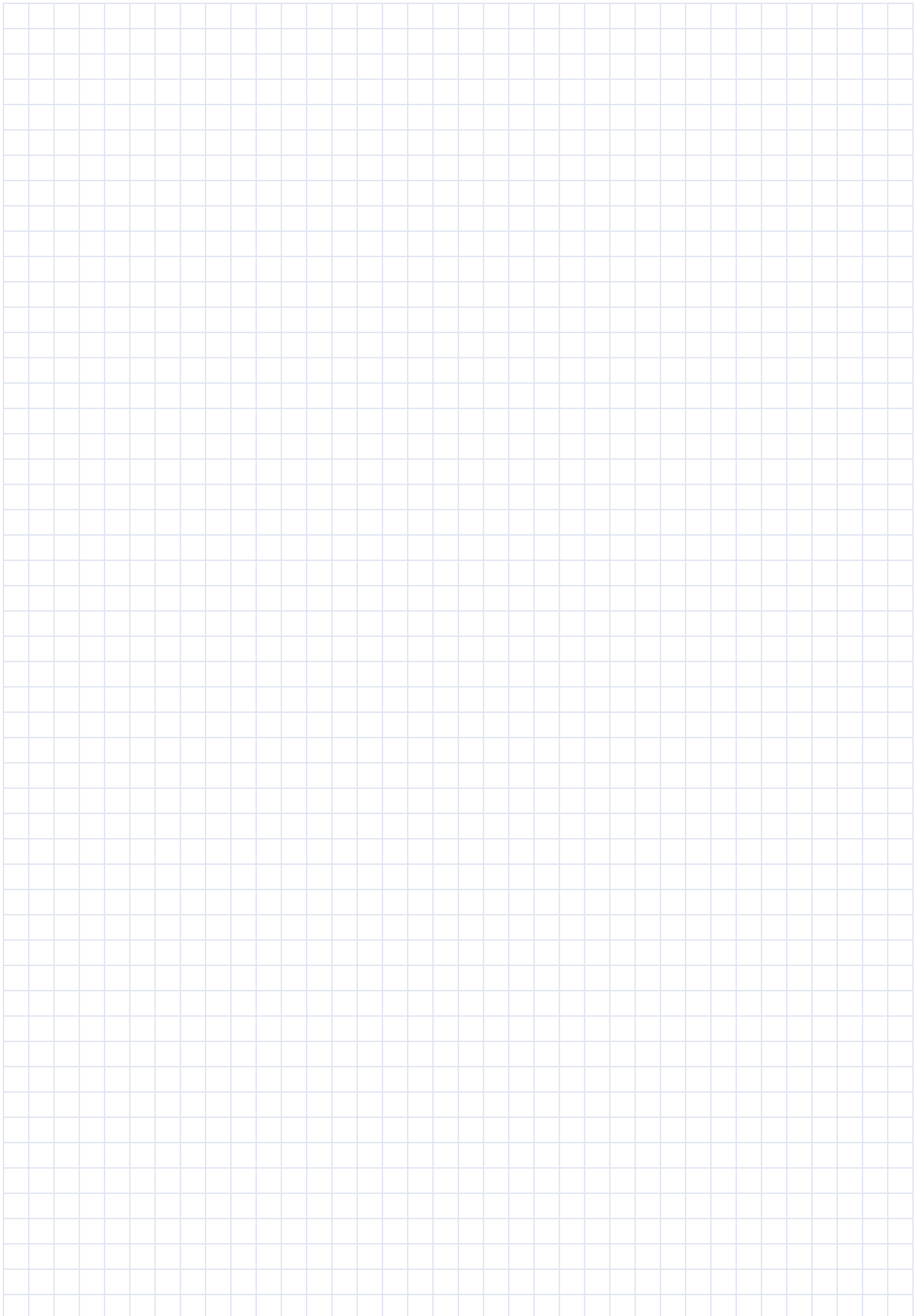

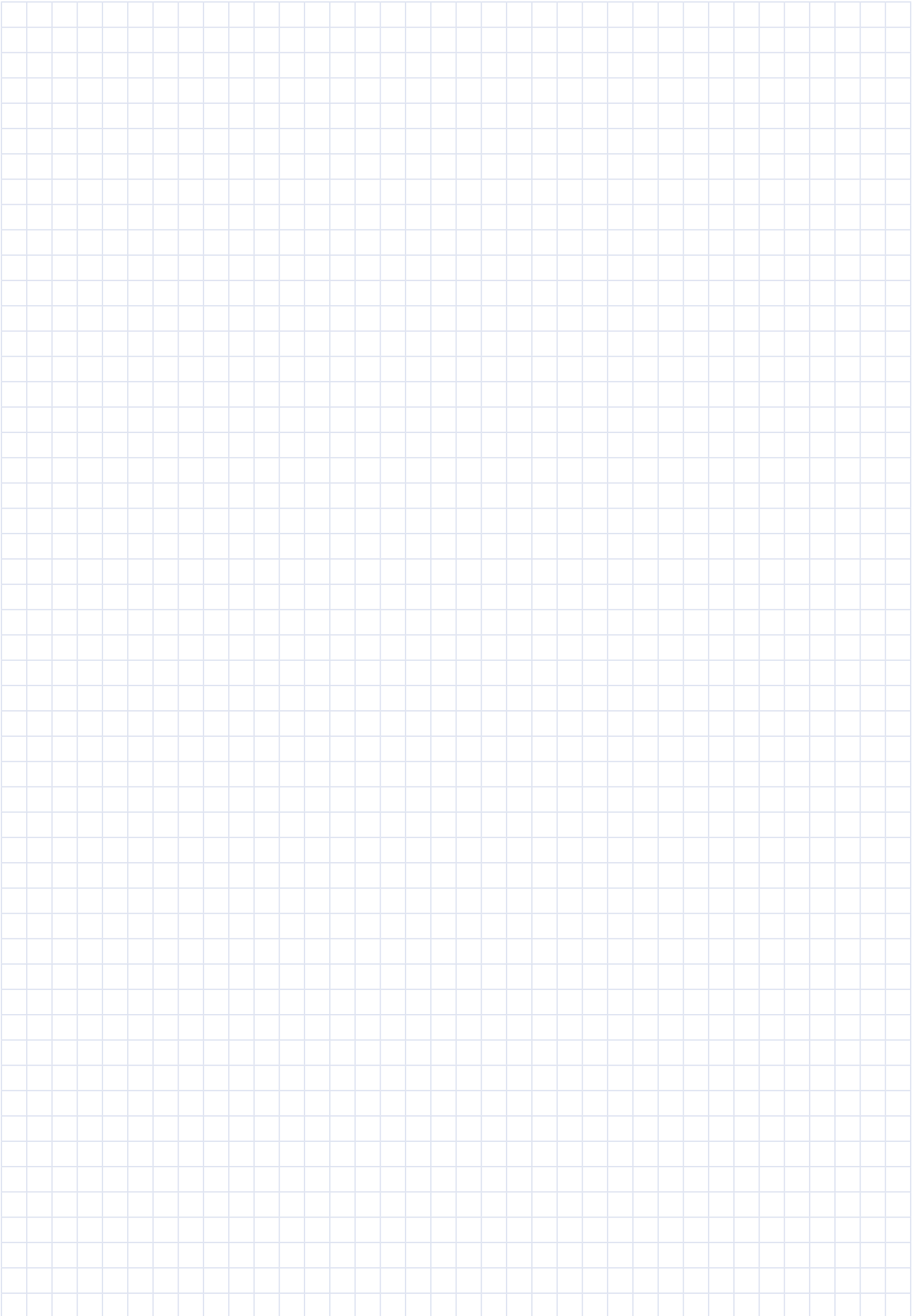

VDO Replacement Parts

- | | | | |
|---|---|----|---------------------------------------|
| 1 | Engine actuators | 6 | HVAC blower and fan systems |
| 2 | Fuel systems | 7 | Screen and headlight washer systems |
| 3 | Sensors for engine management | 8 | Actuators for central locking systems |
| 4 | Sensors for instrumentation | 9 | Diagnostic systems |
| 5 | Sensors for tire pressure monitoring systems (TPMS) | 10 | Common Rail Diesel |
| | | 11 | Battery |

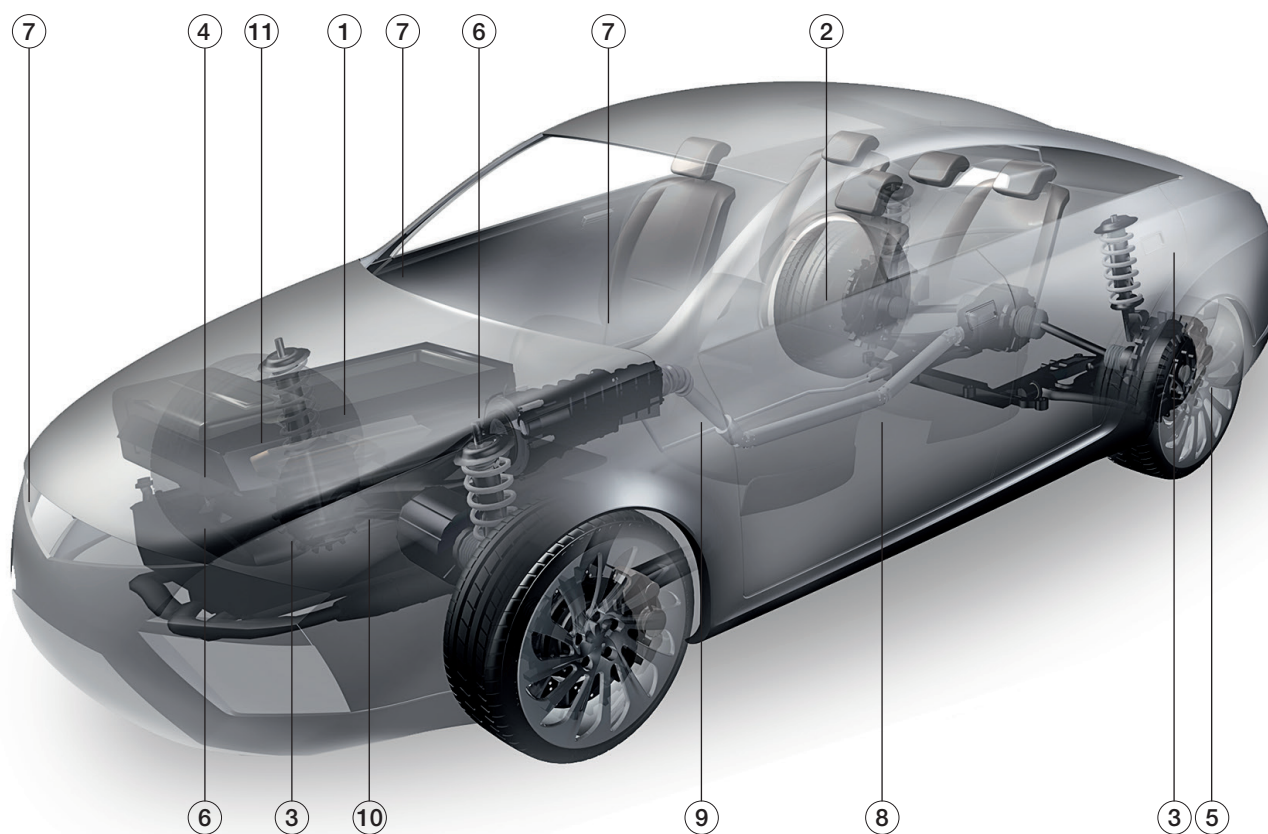

Online Catalog

Please consult our easy-to-use catalogs for detailed, up to date information about the replacement parts available or visit our website at: www.vdo.com



Continental is a certified TecDoc partner.



Continental Trading GmbH

Sodener Strasse 9

D-65824 Schwalbach

Germany

Tel: + 49 6196 87-0

Fax: + 49 6196 86571

www.vdo.com

E-Mail: replacementparts@vdo.com

VDO - A Trademark of the Continental Corporation

A2C595XXXXXX

The information provided in this brochure contains only general descriptions or performance characteristics, which do not always apply as described in case of actual use or which may change as a result of further development of the products. This information is merely a technical description of the product. This information is not meant or intended to be a special guarantee for a particular quality or a particular durability. An obligation to provide the respective characteristics shall only exist if expressly agreed in the terms of contract. We reserve the right to make changes in availability as well as technical changes without prior notice.

Please note: Application – The products described in this catalogue are designed for use in land vehicles, engines and equipment. Disclaimer – The data in this replacement parts catalogue has been compiled and processed for the purpose of presenting our replacement parts range and is correct to the best of our knowledge. Subject to technical alterations, errors and omissions. Availability is not guaranteed. We cannot be held liable with regard to any information contained in the Continental Trading replacement parts catalogue except in case of intent, gross negligence or where mandatory liability is borne in accordance with German product liability law.

A2C595XXXXXX | Continental Trading GmbH © 07/2019
Printed in Germany

VDO