

# MECHANICAL ADAPTORS FOR PUNCHES | ŁĄCZNIKI MECHANICZNE STEMPLI

## joiners | adaptersy



### TYPE "A" | TYP „A”

$H = 100 \text{ mm}, L = 150 \text{ mm}$

$H = 120 \text{ mm}, L = 150 \text{ mm}$

$H = 140 \text{ mm}, L = 150 \text{ mm}$

$H = 150 \text{ mm}, L = 150 \text{ mm}$

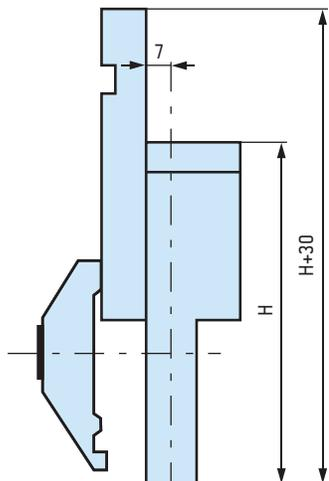

### TYPE "B" | TYP „B”

$H = 120 \text{ mm}, L = 150 \text{ mm}$

$H = 170 \text{ mm}, L = 150 \text{ mm}$

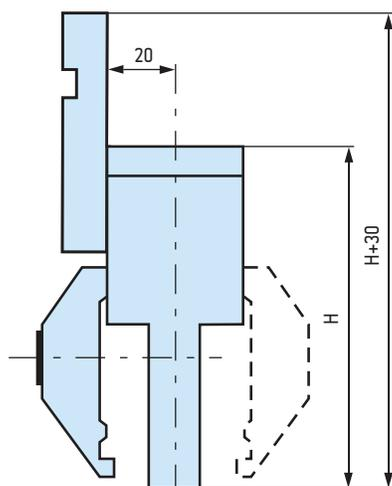

## clamping washers | podkładki mocujące (klamry)



### TYPE "A" | TYP „A”

$H = 50 \text{ mm}, L = 150 \text{ mm}$

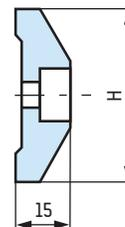

### TYPE "S" | TYP „S”

$H = 58 \text{ mm}, L = 150 \text{ mm}$

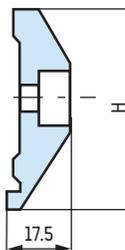

### TYPE "P" | TYP „P”

with plastic insert / z wkładką plastikową

$H = 58 \text{ mm}, L = 150 \text{ mm}$

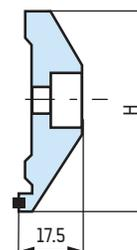

# MECHANICAL ADAPTORS FOR PUNCHES | ŁĄCZNIKI MECHANICZNE STEMPLI



TYPE "Q" | TYP „Q”

H = 60 mm, L = 150 mm

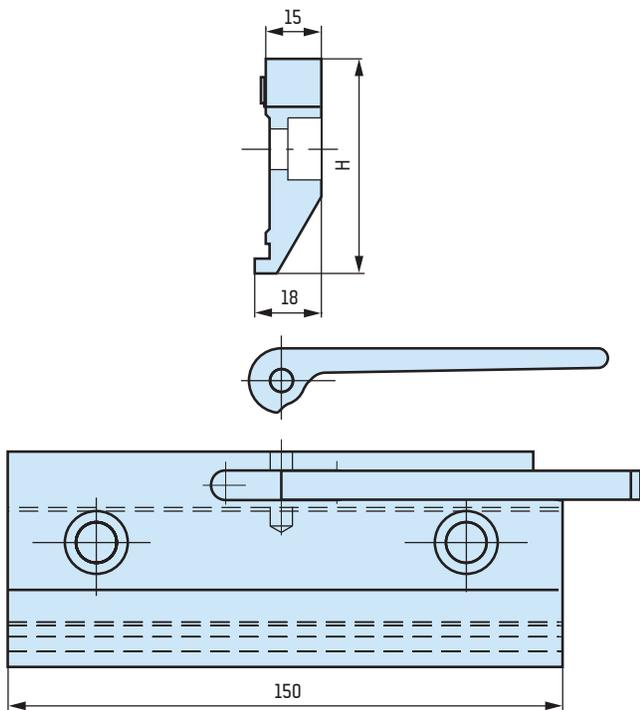

system changing adaptors |  
adapтеры міжсистемові



TYPE "T/A" | TYP „T/A”

H = 80 mm, L = 150 mm

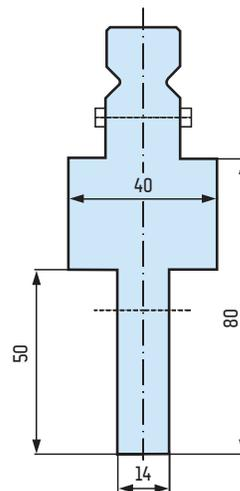

type "T" adaptor | adapter typu „T”



TYPE "T/T" | TYP „T/T”

H = 60 mm, L = 100 mm

H = 80 mm, L = 100 mm

H = 100 mm, L = 100 mm

H = 150 mm, L = 100 mm

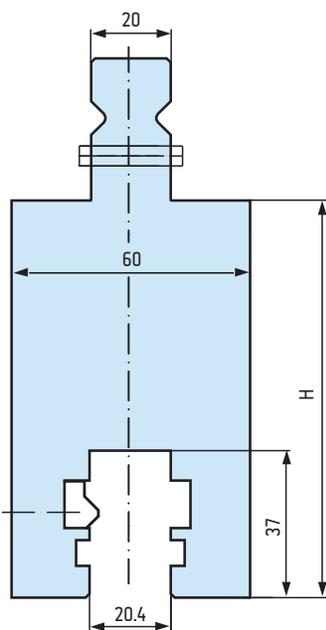

TYPE "A/T" | TYP „A/T”

H = 100 mm, L = 100 mm

