

OAL	608	FL	588
PSL	552	WL	300
CL	500	Mark 1	DIRTECH + lot
ITI	568	Mark 2	DC400V2500W500NH

Wire: SILIFLON UL 1727 AWG 18 600V 250°C (white)
OMERIN or equivalent

Terminal: Splice RSB 7792.002V-1.5 STOCKO or equivalent

Specifications:

Nominal voltage: 400 V

Wattage: 2500 W ± 5%

Average life: 5000 Hrs (with AC power supply, 50 or 60 Hz,
continuously at room temperature and free from vibration)

Lighting position: Horizontal ± 4°

Tc 2650 K

Strength test:

- Wire harness shall withstand tensile load of 5 Kgf in lamp axis direction.

- Insulator base shall withstand tensile load of 1 Kgf in lamp axis direction.

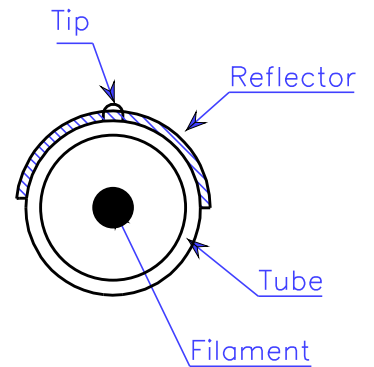

Type: InfraRed Halogen Lamp Heater DC 400V 2500W 500 NH		Modif.:	
		Date:	
Date: 16-12-13	DIRTECH	Version IC-138	Comments