

# FLEXITRAILER FT-LS-S

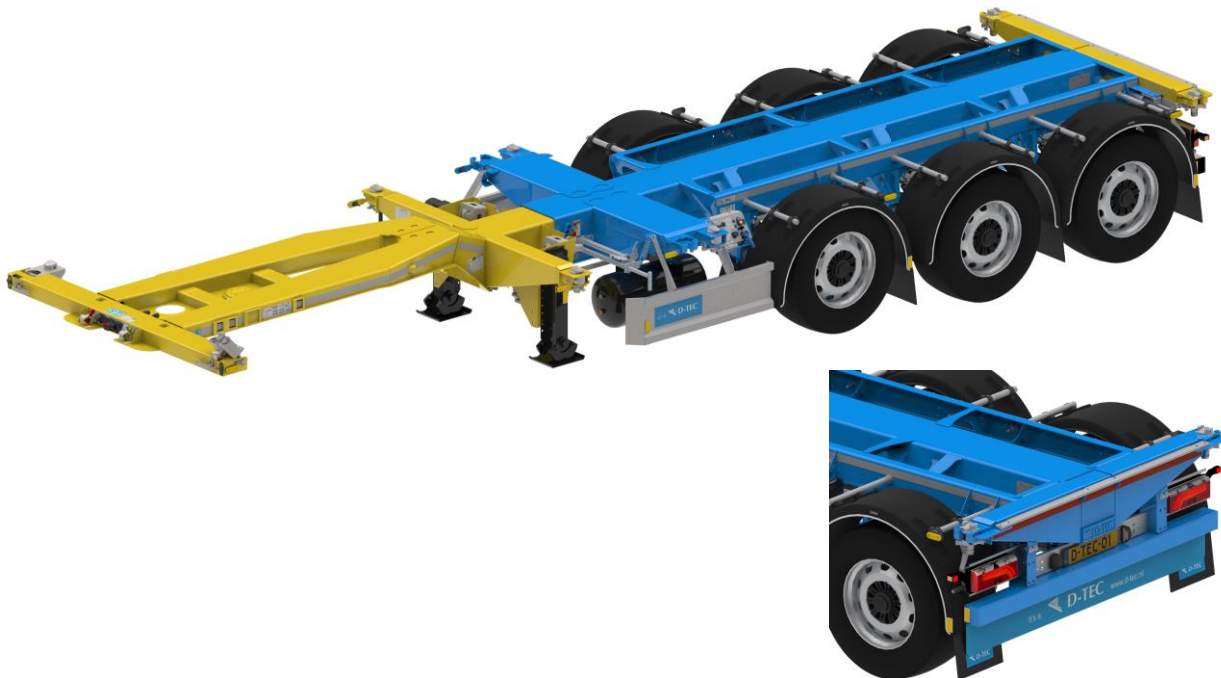

**Date tehnice:**

Disponibil pentru

Sarcina pe cui  
 Sarcina max. axa  
 Sarcina totala sasiu  
 Greutate sasiu  
 Sarcina utila  
 Inaltime de cuplare  
 Inaltime sasiu  
 Dimensiune anvelope  
 Conexiune electrica

**Technische Daten**

Geeignet für

Sattellast  
 Max. Achslast per Achse  
 Gesamt zulässige Masse  
 Leergewicht  
 Nutzlast  
 Sattelhöhe  
 Chassishöhe  
 Reifengröße  
 Elektrische Anschlüsse

**Technical data**

Suitable for

Kingpin weight  
 Maximal Axleload / axle  
 Gross trailer weight  
 Empty weight  
 Payload  
 Fifthwheel height  
 Chassisheight  
 Tyresize  
 Electrical connectors

**FT-LS-S**

20 ft rear  
 20 ft central (optional)  
 30 ft (optional)  
 2x 20 ft  
 40 ft (HC)  
 45 ft  
 16.000 kg  
 9.000 kg  
 43.000 kg  
 4.600 kg  
 38.400 kg  
 1.110 mm  
 1.110 mm  
 385/55 R22,5  
 1x 15 pin

**OPTIUNI / OPTIONEN / OPTIONS**

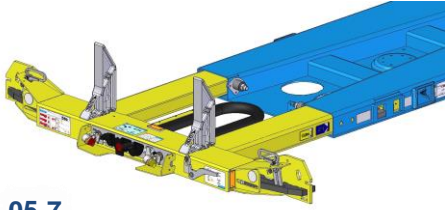

05-7

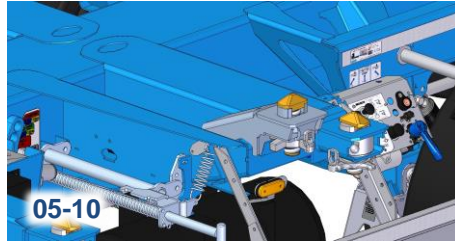

05-10



05-11

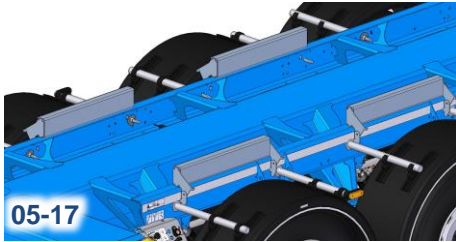

05-17



11-2-17



11-15



15-17



15-14



15-15

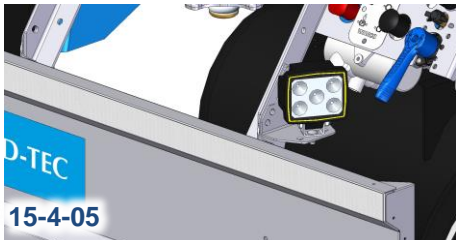

15-4-05

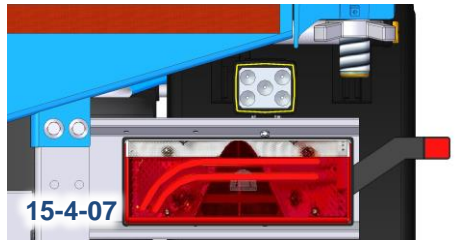

15-4-07

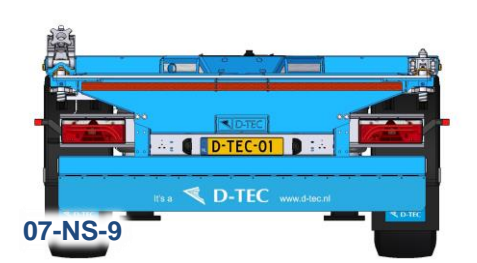

07-NS-9

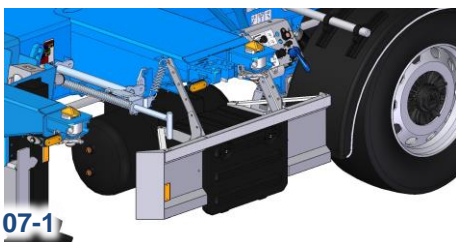

07-17

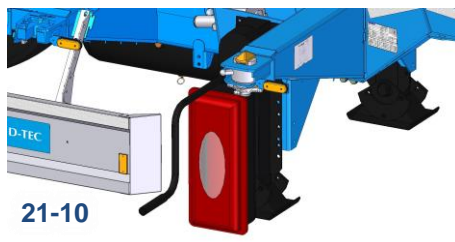

21-10

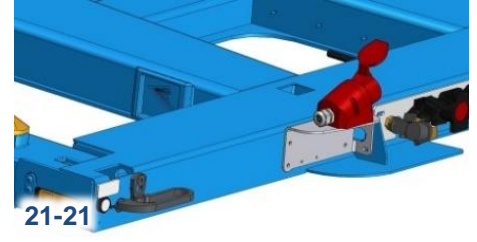

21-21



07-NS-12/13/14

