

SDcam CCTV Camera

SDC-24DS Series

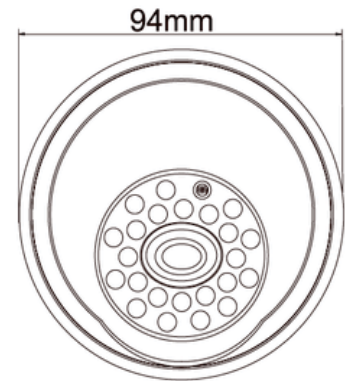
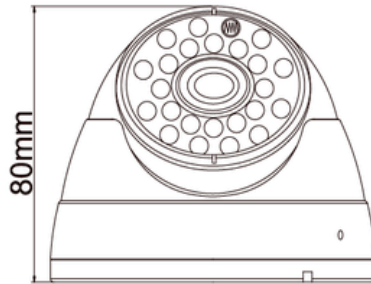

Specifications

Model Name	SDC-24DS
Image Device	1/3 SONY
Resolution	420 LTV
Picture Elements	PAL:500(H)×582(V); NTSC:510(H)×492(V)
Min. Illumination	1.0 Lux /F2.0
TV System	PAL/NTSC
Lens Furnished	3.6 mm Board Lens (Optional 4mm or 6mm Board Lens)
Infrared Luminary	24 pieces □5 mm IR-LED
Illuminate Distance	20 M
Wavelength	850 nm
Waterproofing Criterion	IP 66
S/N Ratio	More than 48dB
Electronic Shutter	NTSC:1/60~1/100,000, PAL:1/50~1/110,000
Gamma	0.45
White Balance	Auto
Gain Control	Auto
Sync. System	Internal
Video Output	1 Vp-p / 75 Ohms
Power Supply	DC12V±10%
Operation Temperature	-10□ ~ +50□ RH95% Max
Dimension	φ94 x 80 mm
Weight	450g

Design and specifications are subject to change without notice.

Distributed in Romania by SC Telesystem SRL - www.telesystem.ro (+4) 0234.55.10.55