

TECHNIK DIE BEWEGT

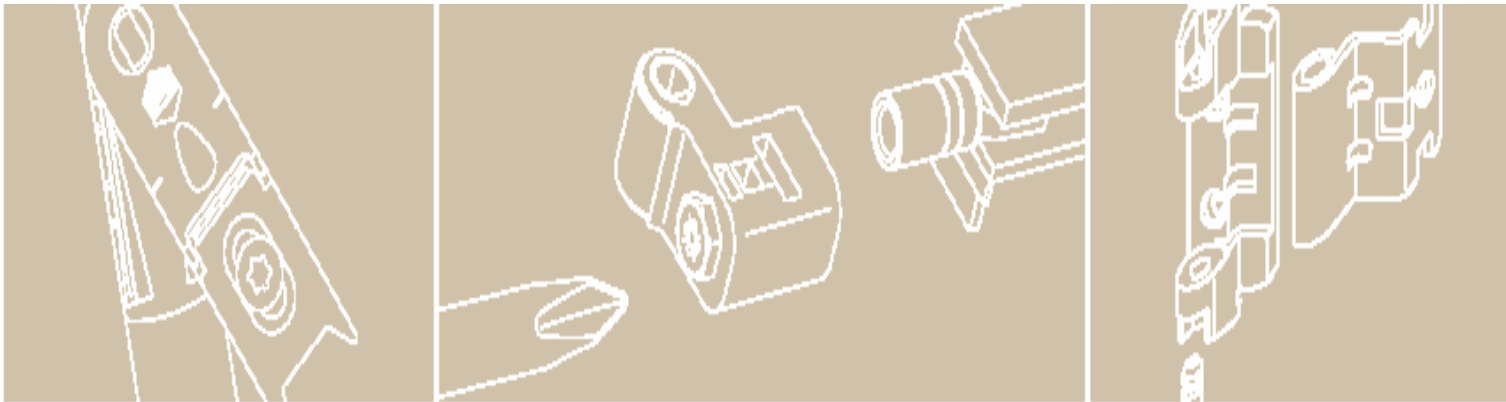

MACO MULTI-TREND



Catalog 2007

Feronerie pentru ferestre din lemn si lemn stratificat

Legenda



Pentru lemn



Cod



Cota de falt a cercevelei pe latime (FFB)



Cota de falt a cercevelei pe inaltime (FFH)



Cota de falt a cercevelei pe latime cu coltarul egal



Cota de falt a cercevelei pe latime cu coltarul inegal



Cota de falt a cercevelei pe latime si inaltime



Inaltimea manerului de la cota de falt



Unitatea de coletare



Numarul de suruburi necesare fixarii

L

Lungimea totala a piesei

Z

Cota la care se afla rola de inchidere

Fr.

Diametrul frezei

I.ex.

Diametrul exterior al inelului de centrare pe sablon

I.in.

Diametrul interior al inelului de centrare pe sablon





Informatii generale

Indicatii pentru productie

1. Stabilirea dimensiunilor admise a cercevelor pentru ferestrele si ferestrele-usi de balcon oscilo-batante

A. Domeniu de intrebuintare

Limita de utilizare

Max.	FFB 1400 FFH 2350	Suprafata maxima 2,4m ² si greutatea maxima, a cercevelei, de 120 Kg. Raportul maxim FFH:FFB => 1:1,5
Min.	FFB 280 FFH 370	Folosind coltarul inegal, foarfeca Gr.00 si tija cremon OB constanta

B. Determinarea greutatii geamului

Grosimea geamului in mm	24	22	20	18	16	14	12	10	8
Greutatea Kg/m ²	60	55	50	45	40	35	30	25	20

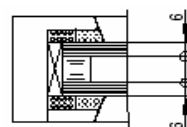

= Grosime distantier

c. Greutatea maxima sustinuta

Max. 130 Kg. Varianta DT	Max. 130 Kg. Varianta TO
Se utilizeaza balamale de toc sus si jos DT cu doua pahare de asezare de >0< 34 mm, adinci de 5 mm.	Se utilizeaza balamaua de toc sus si jos TO cu un pahar de asezare de >0< 34 mm, adinci de 20 mm.



Indicatii pentru productie

2. Diagrame pentru stabilire greutatii maxime a cercevelor

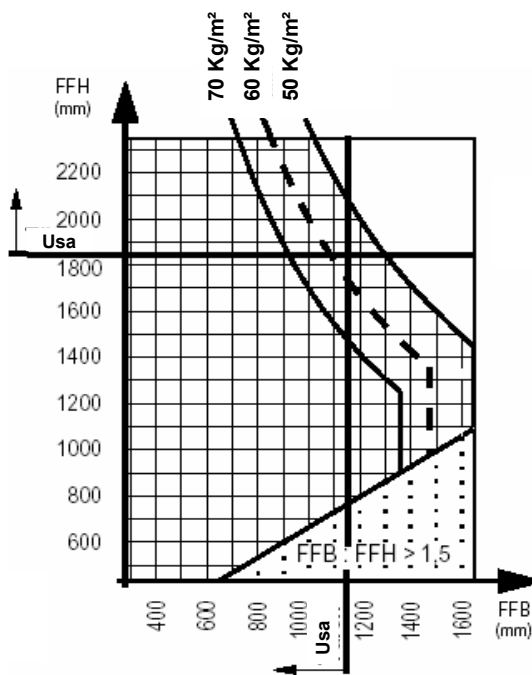
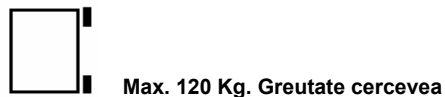
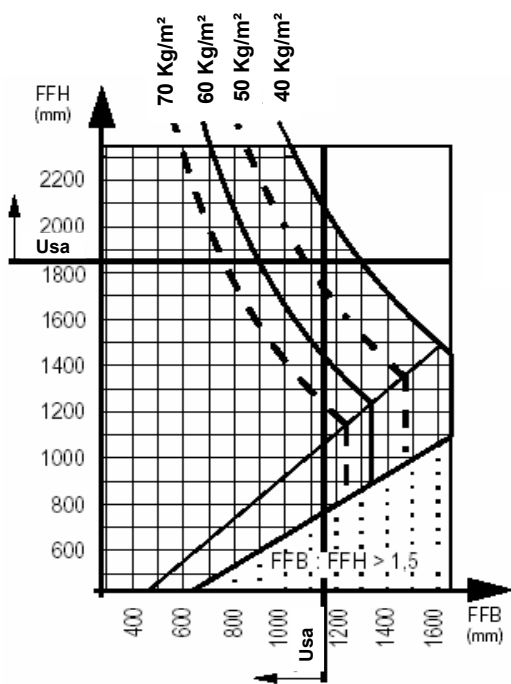
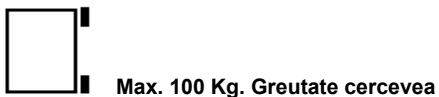
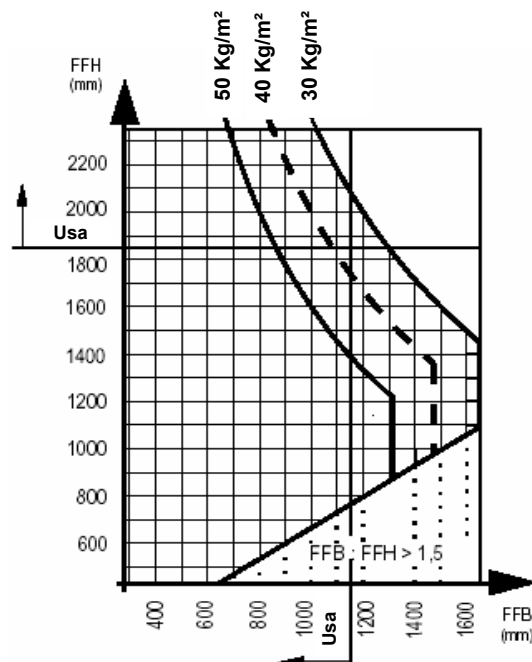
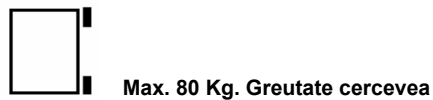
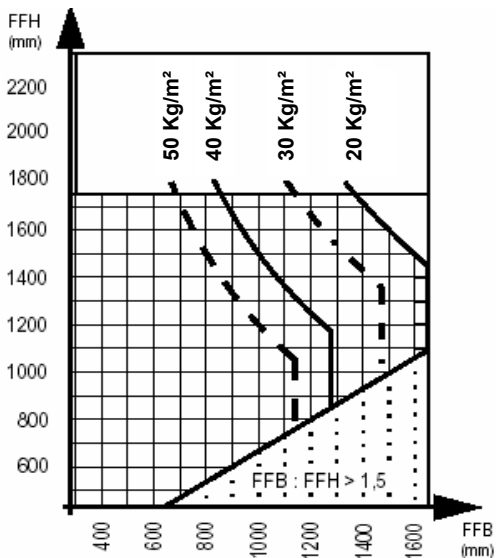



Informatii generale

Indicatii pentru productie



Max. 80 Kg. Greutate cercevea

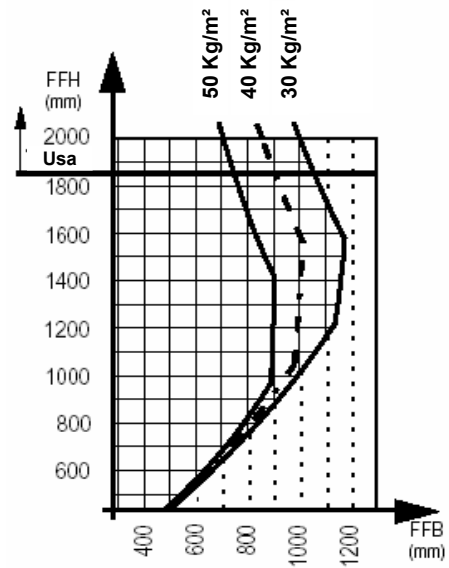
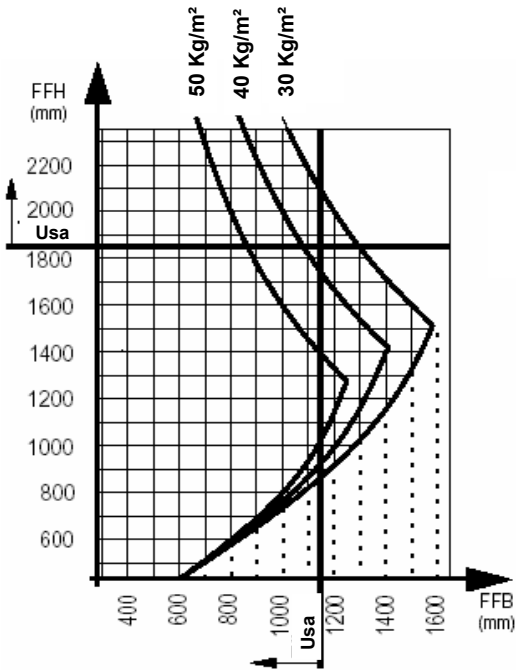

Informatii generale

Folosirea si intretinerea corecta a ferestrelor

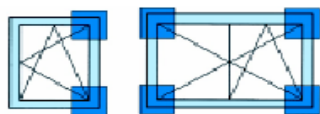

Intretinerea feroneriei oscilo-batante MULTI TREND

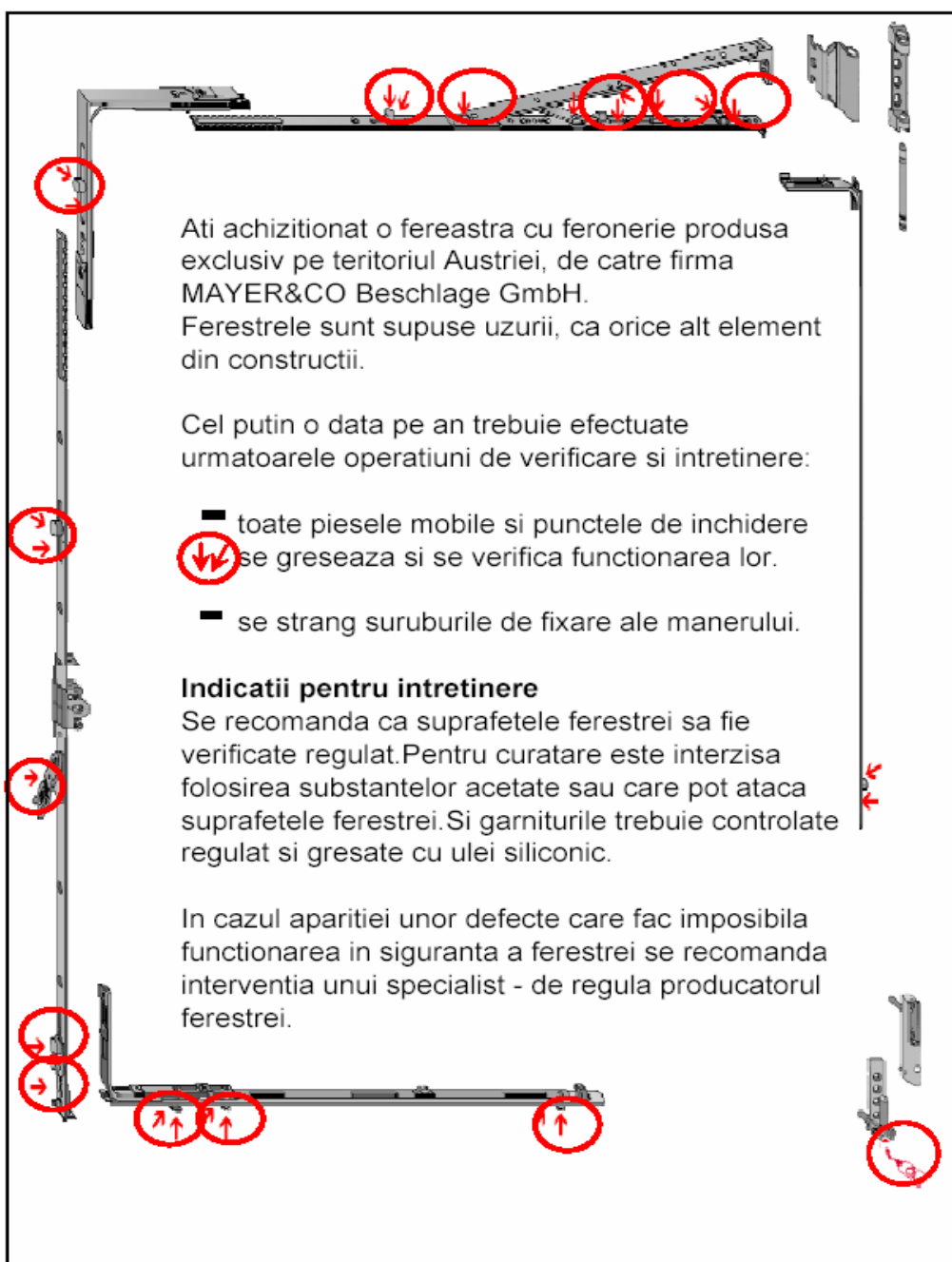

Ati achizitionat o fereasta cu feronerie produsa exclusiv pe teritoriul Austriei, de catre firma **MAYER&CO Beschlage GmbH**. Ferestrele sunt supuse uzurii, ca orice alt element din constructii.

Cel putin o data pe an trebuie efectuate urmatoarele operatiuni de verificare si intretinere:

- toate piesele mobile si punctele de inchidere se gresaza si se verifica functionarea lor.
- se strang suruburile de fixare ale manerului.

Indicatii pentru intretinere
Se recomanda ca suprafetele ferestrei sa fie verificate regulat. Pentru curatare este interzisa folosirea substantelor acetate sau care pot ataca suprafetele ferestrei. Si garniturile trebuie controlate regulat si gresate cu ulei siliconic.

In cazul aparitiei unor defecte care fac imposibila functionarea in siguranta a ferestrei se recomanda interventia unui specialist - de regula producatorul ferestrei.

Informatii generale

Folosirea si intretinerea corecta a ferestrelor

Reglaje ce trebuie efectuate de
producatorul ferestrei dumneavoastra

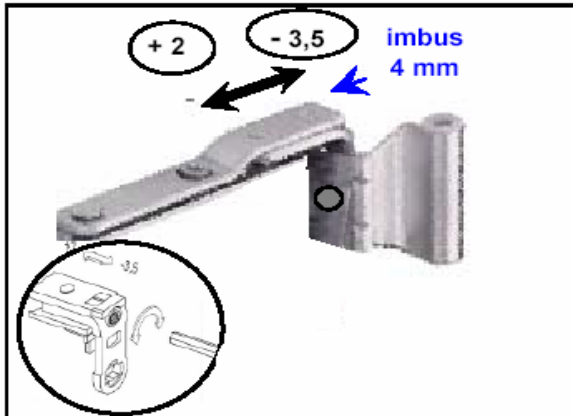

Reglarea laterala a cercevelei

Varianta cu balamale
DT

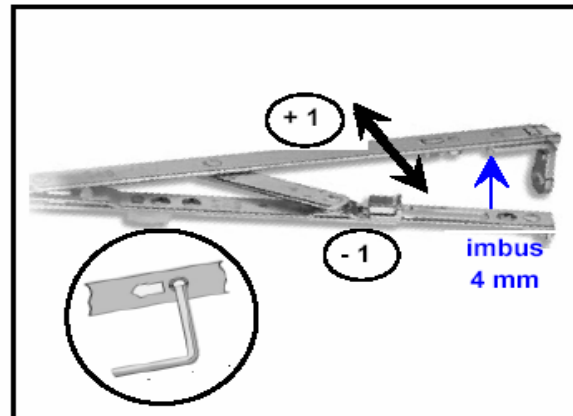

Reglarea presiunii pe garnitura

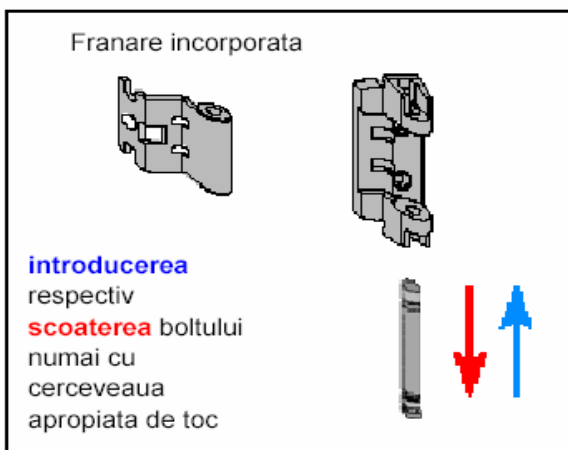

Montajul boltului

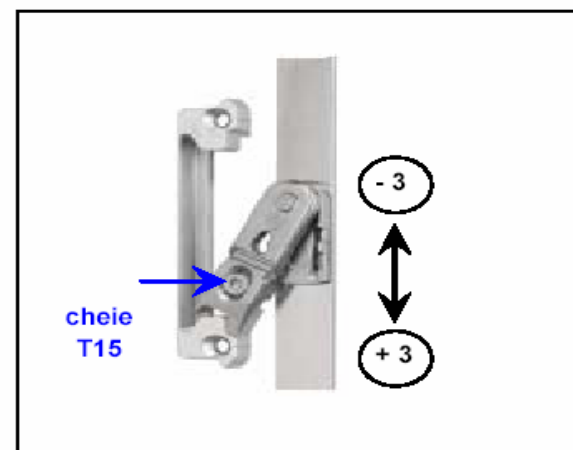

Reglarea ridicatorului

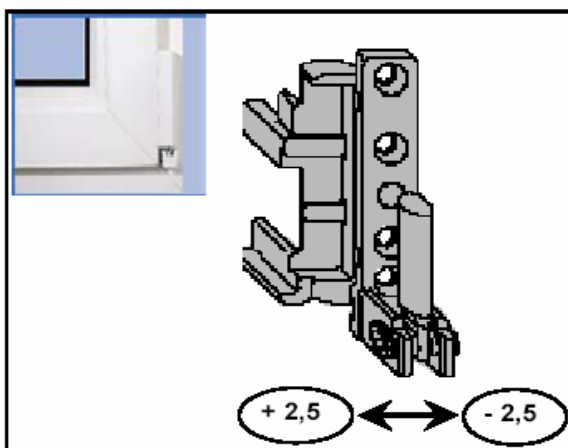

Reglarea laterala a cercevelei

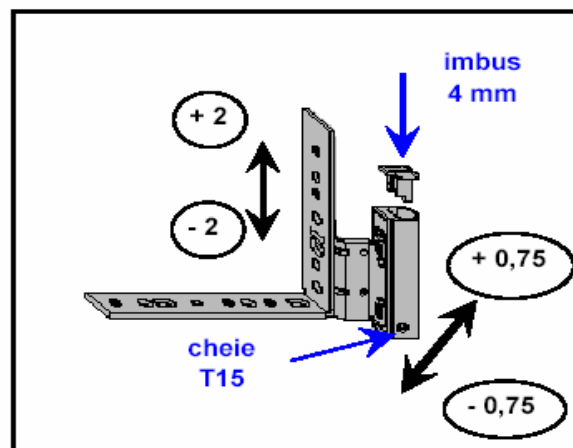

Reglarea in inaltime si a presiunii

Informatii generale

Folosirea si intretinerea corecta a ferestrelor

Reglaje ce trebuie efectuate de
producatorul ferestrei dumneavoastra

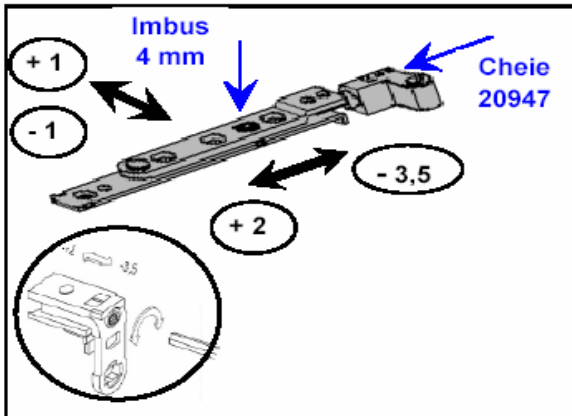

Reglarea laterala a cercevelei

Varianta cu balamale
TO

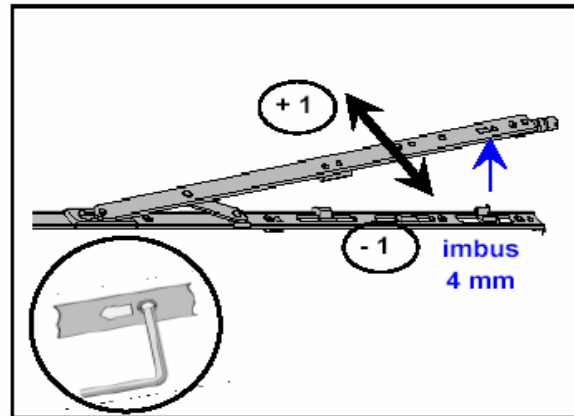

Reglarea presiunii pe garnitura

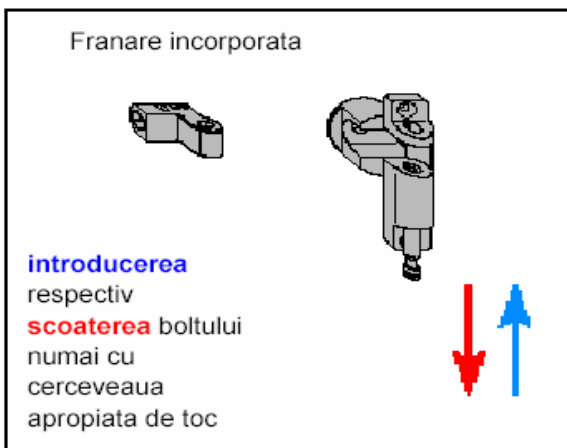

Montajul boltului

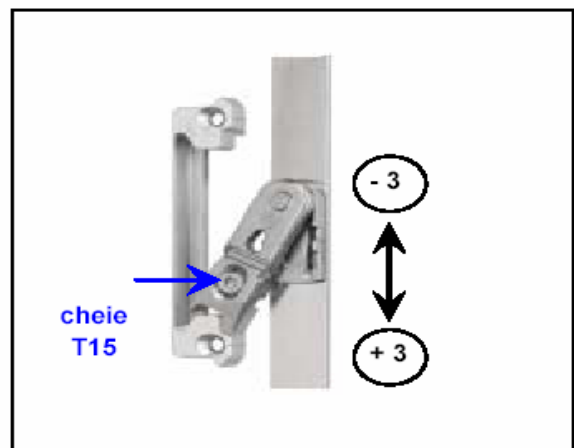

Reglarea ridicatorului

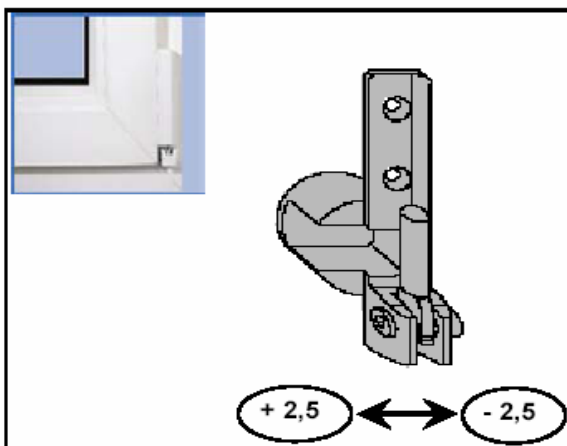

Reglarea laterala a cercevelei

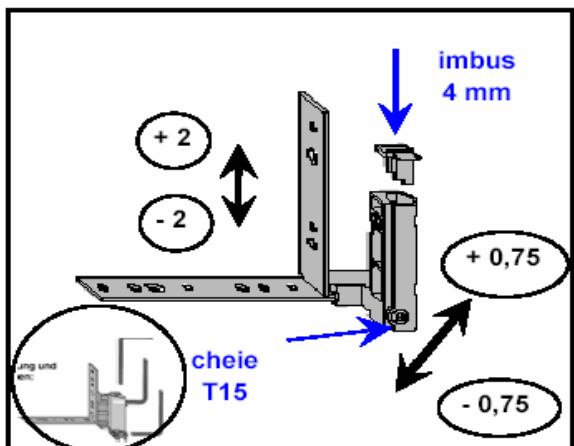

Reglarea in inaltime si a presiunii

Informatii generale

Folosirea si intretinerea corecta a ferestrelor

Instructiuni de folosire

Pentru a evita defectarea ferestrei:

- nu atarnati obiecte de cercevea.
- nu fortati deschiderea cercevei mai mult decat o permite pozitia de montaj.
- nu introduceti obiecte intre toc si cercevea.

Pentru a evita accidentele evitati urmatoarele:

- pericolul de strivire intre toc si cercevea la inchiderea ferestrei.
- pericolul de cadere prin fereastră deschisa.
- pericolul de lovire de catre cerceveaua miscata de curentii de aer.

Funcționarea ferestrei oscilo-batante (vezi desenul)

- albastru:** fereastră deschisa oscilant pentru aerisire.
- rosu:** fereastră deschisa batant pentru aerisire rapida si curatire.
- verde:** fereastră inchisa etans.

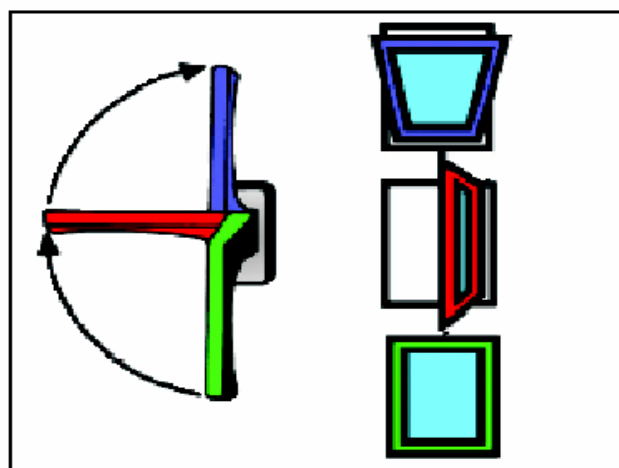
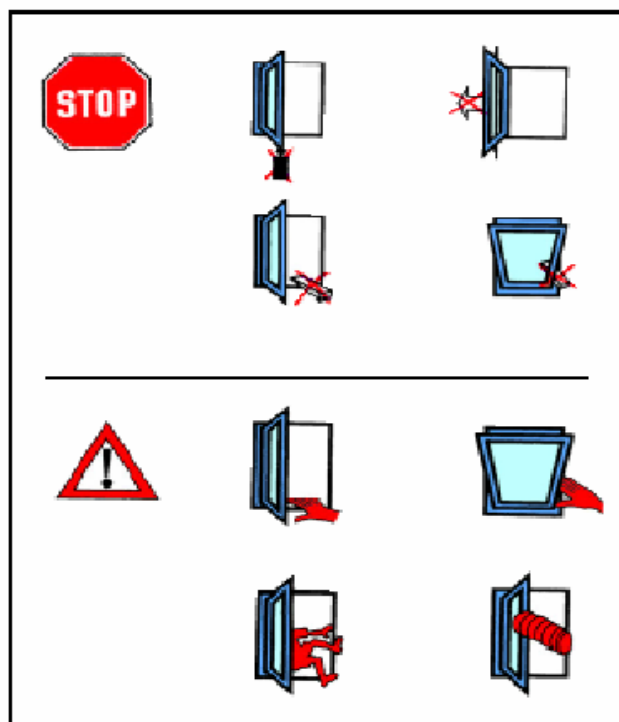

Atentie!

Ferestrele lasate deschise in pozitie batanta trebuie fixate sau asigurate.

Garantie

Respectarea riguroasa a instructiunilor de folosire si intretinere este absolut necesara pentru pastrarea garantiei oferite de constructorul ferestrei.

Fereastra oscilo-batanta un canat

A Feronerie oscilo-batanta "MACO MULTI TREND"

tija cremon OB cu siguranta contra manevrarii incorecte si functia de ridicator, cu role de inchidere, cu foarfeca, balamale de toc si cercevea, precum si maner.

Inchidere orizontal basculanta: permite deschiderea in plan oscilant si asigura inchiderea de siguranta "nivelul de baza".

Inchidere suplimentara: pentru FFB >800 mm si FFH >800 mm
Consultati recomandarile producatorului de profile.

Foarfeca a-2-a: pentru FFB 1400 -1650 sau cercevele cu o greutate mai mare de 100 Kg.

Nota: Suplimentar se poate folosi foarfeca cu deschidere in doua trepte, limitator deschidere la 90°, blocator, maner cu blocare din buton sau din cilindru.

Usa de balcon: Schnapper (rola) si maner exterior (pentru usa balcon)
(Fereastra)

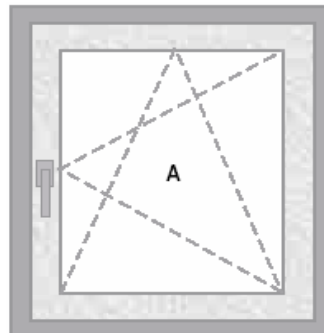

Fereastra oscilo-batanta doua canaturi

A Cerceveaua oscilo-batanta

Valabile informatiile de la "Fereastra oscilo-batanta un canat".

Fereastra din lemn: pentru FFH >800mm se foloseste inchiderea suplimentara si coltarul cu doua role de inchidere

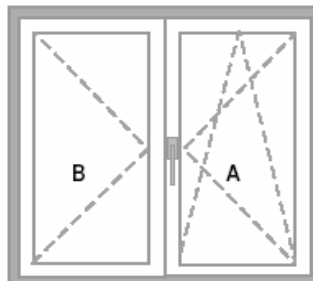

B Cerceveaua cu stulp

Varianta 1: balama toc sus si jos, balama cercevea sus si jos, balama simpla deschidere, zavor sus si jos.

Balamaua de mijloc (toc si cercevea) apare pentru FFH >800mm.
Consultati recomandarile producatorului de profile.

Usa de balcon: se folosesc 2 balamale de mijloc
(Fereastra)

Varianta 2: balama toc sus si jos, balama cercevea sus si jos, balama simpla deschidere, tija inchidere stulp, zavor pentru tija stulp.

Balamaua de mijloc (toc si cercevea) apare pentru FFH >800mm.
Consultati recomandarile producatorului de profile.

Daca pe stulp este montata "tija inchidere stulp constanta" pe canatul principal este obligatoriu se se monteze "tija cremon constanta".

Daca pe stulp este montata "tija inchidere stulp variabila" pe canatul principal este obligatoriu se se monteze "tija cremon variabila".

Usa de balcon: se folosesc 2 balamale de mijloc
(Fereastra)

Nota: Suplimentar se poate folosi foarfeca cu deschidere in doua trepte, limitator deschidere la 90°, blocator, maner cu blocare din buton sau din cilindru.

Usa de balcon: Schnapper (rola) si maner exterior (pentru usa balcon)
(Fereastra) Alternativ: tija cremon cu blocare din cilindru, maner interior si exterior cu rozata.

Fereastra trapezoidală oscilo-batantă un canat

C Feronerie oscilo-batantă "MACO MULTI TREND"

Tija cremon OB cu siguranță contra manevrării incorecte și funcția de ridicător, cu role de închidere, cu foarfeca pentru trapez, balamale de toc și cercevea, colțar de legătură, colțar superior pentru trapez, transmisie pentru trapez, precum și maner.

Inchidere orizontală basculantă: permite deschiderea în plan oscilant și asigură închiderea de siguranță "nivelul de bază".

Inchidere suplimentară: pentru FFB >800 mm și FFH >800 mm
Consultati recomandările producătorului de profile.

Nota: Suplimentar se poate folosi limitator deschidere la 90°, blocator, maner cu blocare din buton sau din cilindru.

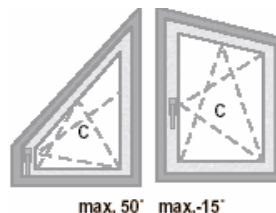

Fereastra cu arcada si cu element curb, oscilo-batanta un canat

D Feronerie oscilo-batanta "MACO MULTI TREND"

Tija cremon OB cu siguranta contra manevrarii incorecte si functia de ridicator, cu role de inchidere, cu foarfeca, balamale de toc si cercevea, mecanism pentru arcada, precum si maner.

Foarfeca II: pentru FFB >1070mm

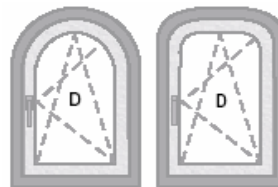

Fereastra cu arcada si cu element curb, oscilo-batanta doua canaturi

E Cerceveaua oscilo-batanta

Tija cremon OB cu siguranta contra manevrarii incorecte si functia de ridicator, cu role de inchidere, cu foarfeca, balamale de toc si cercevea, mecanism pentru arcada, precum si maner.

Foarfeca II: pentru FFB >1070mm

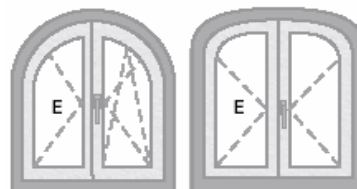

Cerceveaua cu stulp

Varianta 1: balama toc sus si jos, balama cercevea sus si jos, balama simpla deschidere, zavor sus si jos.

Balamaua de mijloc (toc si cercevea) apare pentru FFH >800mm.

Consultati recomandarile producatorului de profile.

Usa de balcon: se folosesc 2 balamale de mijloc
(Fereastra)

Varianta 2: balama toc sus si jos, balama cercevea sus si jos, balama simpla deschidere, tija inchidere stulp, zavor pentru tija stulp.

Balamaua de mijloc (toc si cercevea) apare pentru FFH >800mm.

Consultati recomandarile producatorului de profile.

Daca pe stulp este montata "tija inchidere stulp constanta" pe canatul principal este obligatoriu se se monteze "tija cremon constanta".

Daca pe stulp este montata "tija inchidere stulp variabila" pe canatul principal este obligatoriu se se monteze "tija cremon variabila".

Usa de balcon: se folosesc 2 balamale de mijloc
(Fereastra)

Nota: Suplimentar se poate folosi limitator deschidere la 90°, blocator, maner cu blocare din buton sau din cilindru.

Usa de balcon: Schnapper (rola) si maner exterior (pentru usa balcon)

(Fereastra) Alternativ: tija cremon cu blocare din cilindru, maner interior si exterior cu rozata.

Fereastra cu segment curb, oscilo-batanta un canat

F Feronerie oscilo-batanta "MACO MULTI TREND"

Pentru 10% din ferestre se folosesc elementele de la varianta "C".
Pentru celelalte ferestre se folosesc elementele de la varianta "D".



Fereastra cu segment curb, oscilo-batanta doua canaturi

G Cerceveaua oscilo-batanta

Se folosesc elementele de la varianta "C" sau "E".

Cerceveaua cu stulp

Se folosesc elementele de la varianta "B 1" sau "B 2".

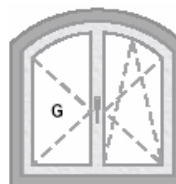

Nota: Suplimentar se poate folosi limitator deschidere la 90°,
blocator, maner cu blocare din buton sau din cilindru.

Fereastră batantă un canat

H Feronerie batantă "MACO MULTI TREND"

- Varianta 1: Tija cremon B, balama simplă deschidere, balamale de toc și cercevea, precum și maner.
- Varianta 2: Tija cremon OB cu siguranță contra manevrării incorecte și funcția de ridicător, cu role de închidere, cu balama simplă deschidere, balamale de toc și cercevea, închizător final cu mișcare 90°, precum și maner.

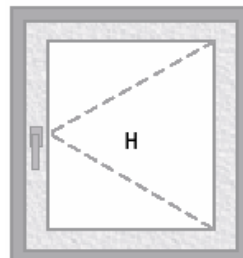

Inchidere orizontal basculantă: asigură închiderea de siguranță "nivelul de bază".(pentru varianta 2)

Inchidere suplimentară sus și jos: pentru FFH >800 mm și FFH >800 mm.(pentru varianta 2)
Consultati recomandările producătorului de profile.

Nota: Suplimentar se poate folosi limitatorul cu deschidere la 90°, blocator, maner cu blocare din buton sau din cilindru.

Usa de balcon: Schnapper (rola) și maner exterior (pentru usa balcon)
(Fereastră) Alternativ: tija cremon cu blocare din cilindru, maner interior și exterior cu rozată.(pentru varianta 2)

Fereastră batantă două canaturi

I Cerceveaua batantă

Se folosesc elementele de la varianta "H".

Cerceveaua cu stulp

Se folosesc elementele de la varianta "B 1" sau "B 2".

Balamaua de mijloc (toc și cercevea) apare pentru FFH >800mm.
Consultati recomandările producătorului de profile.

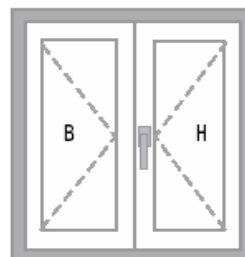

Nota: Suplimentar se poate folosi limitatorul cu deschidere la 90°, blocator, maner cu blocare din buton sau din cilindru.

Usa de balcon: Schnapper (rola) și maner exterior (pentru usa balcon)
(Fereastră)

Fereastră basculanta

K Cerceveaua basculanta

Varianta 1: Tija cremon B, foarfeca de limitare, balama toc si cercevea, balama basculare.

Varianta 2: Tija cremon OB, coltare (stanga si dreapta), prelungitoare (stanga si dreapta), foarfeca de limitare, balama toc si si cercevea, balama basculare.

Pentru FFB > 800mm se monteaza a treilea set de balamale.
Greutatea maxima a cercevelei 60 Kg.

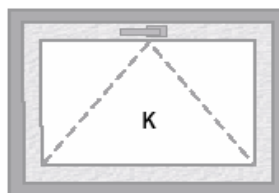

Fereastră combinata

Fereastră trei canaturi cu stulp si montant (teu)

L Cerceveaua oscilo-batanta

Se folosesc elementele de la varianta "A".

Cerceveaua cu stulp

Se folosesc elementele de la varianta "B".

Cerceveaua batanta

Se folosesc elementele de la varianta "H".

Nota: Suplimentar se poate folosi limitatorul cu deschidere la 90°, blocator, maner cu blocare din buton sau din cilindru.

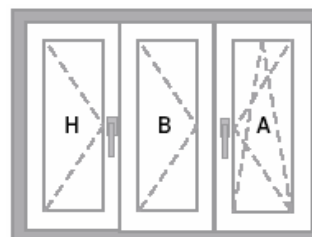

Fereastră combinata

Fereastră doua canaturi cu stulp si supralumina (luminator)

M Cerceveaua oscilo-batanta

Se folosesc elementele de la varianta "A".

Cerceveaua cu stulp

Se folosesc elementele de la varianta "B".

Cerceveaua basculanta

Se folosesc elementele de la varianta "K".

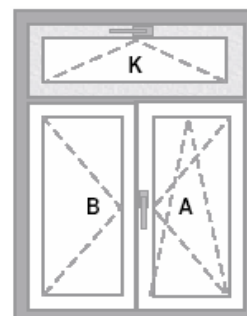

**Informatii tehnice:**

Latimea sinelor	16 mm
Axa gauri pentru maner	15 mm
Inaltimea rozelor de inchidere	8 mm
Cursa rozelor	2 x 19 mm
Diametrul si grosimea mecanismului	25 x 12 mm
Adincimea mecanismului	27,5 mm
Dimensiunea axului de actionare	■ 7 mm

Materiale:

Otel zincat: 2,2 mm pentru sinele fixe

Otel zincat: 3,0 mm pentru sinele mobile

Trei foi de arc: pentru coltare si transmisiile de colt (inchidere suplimentara, inchidere orizontal-basculanta, transmisie pentru ferestre trapezoidale si arcade)

Acoperire:

Tratarea anticorozivna: acoperire cu un strat de zinc de 6 ~15 micrometri

- acoperire cu un strat de zinc de 6 ~15 micrometri
- cromare "silber look"
- sigilare cu ceara, procedeu dezvoltat de MACO care cresta protectia anticorozivna, are proprietati antifrictiune si permite obtinere unei suprafete uniforme.

Siguranta contra manevrarii incorecte - ridicator:

Se gaseste premontata pe tijele cremon OB (de la 600 mm pentru cremoanele constante si de la 750 mm pentru cremoanele variabile). Este interschimbabila (dreapta-stanga) si reglabila pe inaltimi +/- 3 mm.

Nu permite manevrarea manerului atunci cand cerceveaua este deschisa pe una din pozitiile "batanta" sau "oscilanta". Indeplineste cu succes si functia de ridicator - in cazul in care cerceveaua isi schimba geometria, aceasta "siguranta-ridicator" preia sarcina cercevelei si o repune pe pozitia corecta de inchidere.

Inchiderea-zavararea

Forma speciala ale rozelor de inchidere permit obtinerea unei inchideri de siguranta si etanseitate spotita.

Dimensiunea pe verticala a rozelor de inchidere de 9 mm.

Dimensiunea pe orizontala a rozelor de inchidere de 12 mm.

Reglajul standard rozelor de inchidere este de 10 mm.

Reglajul rozelor de inchidere de +2 mm; -1 mm presiune pe garnitura.

Balamalele:

Grupurile de balamale de jos si sus sunt reglabile pe trei directii.

Franare incorporata in balama de sus - contra lovirii cercevelei de toc in cazul producerii de curenti.

Protectie la scoaterea stiftului (boltului) - acesta nu poate fi scos sau introdus decat atunci cand cerceveaua se afla cu toata suprafata in contact cu toc.

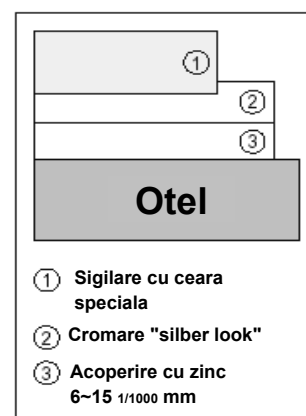

Dimensiunile standardizate pentru sistemele de ferestre din lemn



Luft de 4 mm

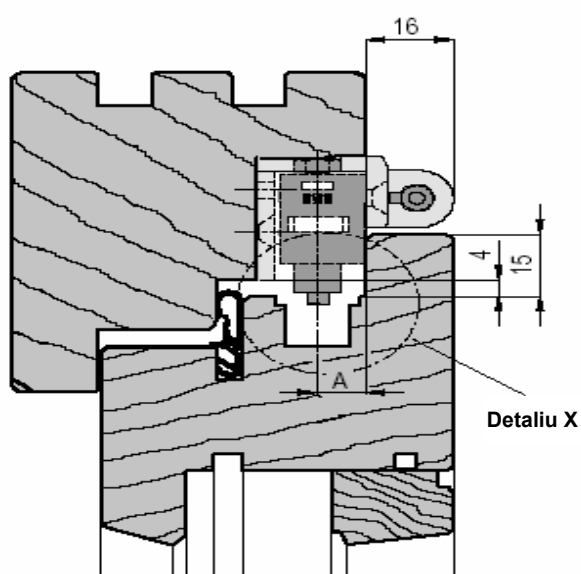

Luft de 11 mm / 12 mm

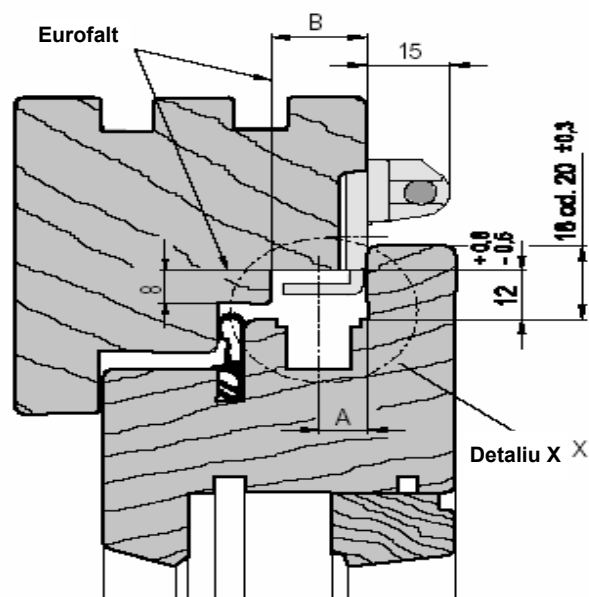
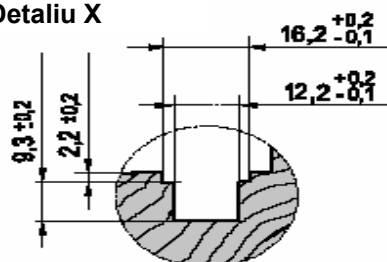
Canal de feronerie
Detaliu X

Euronut 6/8/4 sau 7/8/4

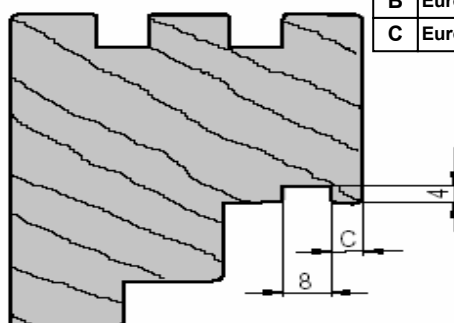

	A	9 mm	13 mm
A	Axa canalului de fer.	9 mm	13 mm
B	Eurofalt	18 sau 20 mm	22 sau 24 mm
C	Euronut	6 sau 7 mm	10 sau 11 mm

Herausgeber: Gütegemeinschaft Schlösser und Beschläge e.V., Offerstr. 12, D-42551 Velbert, 3/98

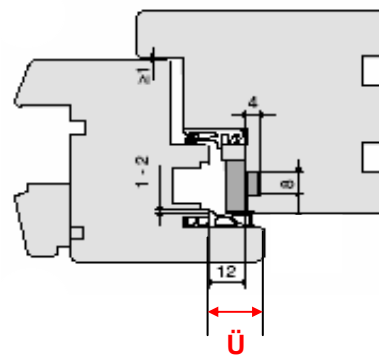
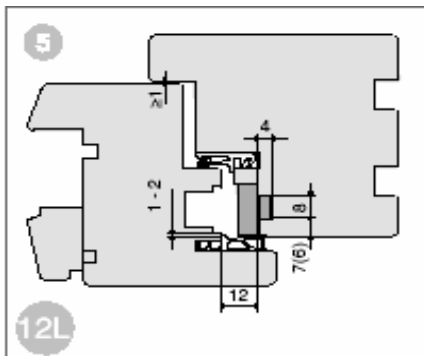
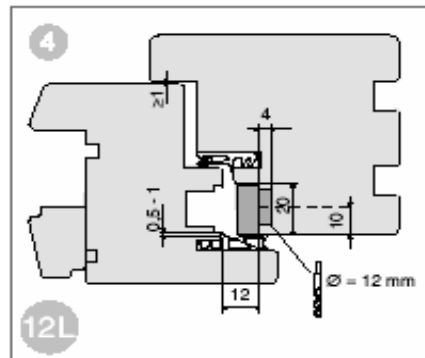
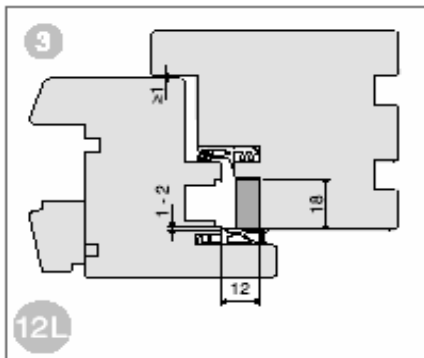
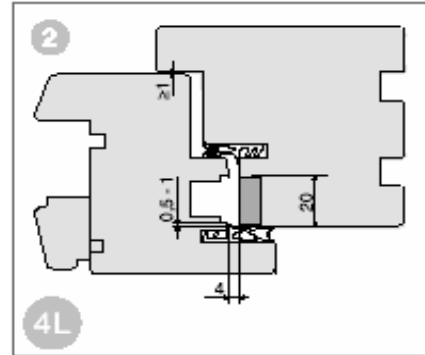
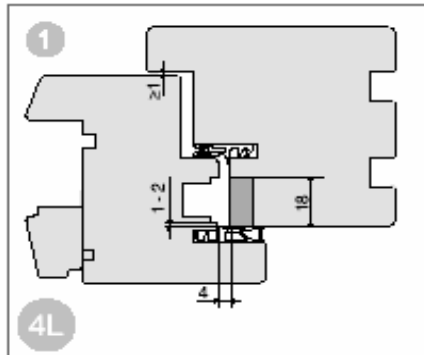

**Institutul pentru testare**

Schlosser und Beschlage

Wallstrasse 41

D-42551 Velbert

REFERAT DE TESTARE**nr.20-14/00**

Beneficiarul și producătorul	Mayer& Co. Beschlage GmbH A-5021 Salzburg
Denumirea obiectului de testat	DK-Elemente..... MACO Suprafețe, SILBER LOOK
Instalație de testare	Test de coroziune DIN 50021-SS
Rezultatul testării	Testarea a fost trecută după comanda de testare Detalii vezi anexa.
Data testării	22.martie 2000
Numele verficatorului	Domnul Battel/Holz

Rezultatele testării se referă exclusiv asupra obiectului verificat.

42551 Velbert 24 martie 2000

Responsabilul pentru postul de testare cât și pentru executarea corectă a testării

H-J Kirchhof
Dipl.Ing.



Referat testare DIN 50021 Ediție iunie 1998		Referat testare Nr.20-14/00 Data de testare 22.03.2000
A	Beneficiarul	Mayer& Co. Beschlage GmbH A-5021 Salzburg
A1	Definirea produsului	DK.-kkk
A2	Comanda de testare	Test de coroziune DIN 50021-SS
A3	Nr.cerut de cicluri	min 240 ore
A4	Cu evaluare parțială Dacă da atunci după	da 72 ore evaluare rugină albă 240 ore evaluare rugină roșie următoarele după 48 ore
A5	Cu evaluare finală	da/după 360 ore, evaluare finală
A6	Cu documentație foto	nu
A7	Rezultatul testului să fie finalizat în formă de referat de testare	da
A8	Anexe fotografii	-----

Referatul prezentat de testare este numai pentru obiectul de testat și supus testării. Un transfer al rezultatelor asupra altui obiect nu este acceptată.

Descrierea testării de coroziune

1. Agățarea obiectelor de testat pe instalațiile prevăzute pentru acest lucru astfel încât nici un obiect de testare să nu atingă cu transpirația sau condensul alt obiect.
2. După încheierea întregii testări respectiv la evaluări intermediare obiectele de testat au fost clătite cu apă distilată și șterse cu o cârpă de lână fără presare.
3. După aceasta urmează imediat evaluarea.



Descrierea obiectelor de testat Suprafață	DK-elemente acoperite MACO SILBER LOOK
--	---

Aparat de testare	Cameră de testare cu stropi de sare tip 450 Sistem Weiss
--------------------------	---

Pretestare înaintea testului propriuzis
--

Existența locurilor atacate	Nu
------------------------------------	----

Documentat fotografic	Nu
------------------------------	----

Anteprepararea obiectelor de testat	Nu
--	----

Evaluare

Ob.de testat	număr ore		Evaluare
1-9	72	rugină albă	nu
1-9	240	rugină roșie	nu
1-9	280	rugină roșie	nu
1-9	336	rugină roșie	nu
1-9	360	rugină roșie	nu

Valoarea PH a rezervorului	trebuie 6,6-7,2	este 6,8
Valoarea PH precipitații	trebuie 6,6-7,2	este 6,5
Rezervor clorid de sodiu	trebuie 50 ±5g	este 5
Cantitate de precipitații	trebuie 1,5ml/h	este 1.5-1,65
Temperatura măsurată	trebuie 23±2°Celsius	este 24

Evaluarea totală	Testarea a fost trecută conform cu firma de testare
După 72 ore nu apare la niciunul din cele 9 elemente acoperite rugină albă	Data 22.03.2000
După 360 ore nu se arată la niciunul din cele 9 elemente acoperite rugină roșie	Verificator Domnul Battel / Holz Persoana ce a evaluat întreg rezultatul Domnul Wichert



Acoperire KTL

O alternativă la galvanizare este acoperirea KTL a elementelor de oțel.

MACO folosește acest procedeu special pentru culorile alb și negru pentru elementele programului acoperirii basculantelor și parțial pentru elementele vizibile de rotire și basculare, a ferestrelor din material sintetic (Benzi de colț, benzi de rotație, sprijin foarfecă, mânere de ferestre)

1. Procedeu

Catoforeza lăcuirii prin scufundare (KTL) este un procedeu special de lăcuire electrochimică prin scufundare.

Prin lăcuire electrochimică se înțelege disocierea lacului din lacurile diluate cu apă pe piesele metalice în procedeul de scufundare. După încheierea procedurii de acoperire prin scufundare, lacul suplimentar se spală cu apă de pe piese iar suprafața rămasă se arde în cuptor.

MACO produce de ani lacuri din rășini acrilice dizolvabile în apă. Înainte se foloseau lacurile din rășini epoxidice.

Acrilatul are în comparație cu epoxidul o rezistență mai mare la razele UV. Epoxidul ia o tentă gri la o expunere mai îndelungată la razele soarelui, prin ploaie sunt ulterior spălate părți de lac.

2. Fosfat de zinc

La fosfatul de zinc este vorba de un strat suport pentru lac.

Fosfatul de zinc nu are valoare din punct de vedere al protecției anticorozive și nu este comparabil cu stratul de zinc aplicat de MACO pe elementele zincate prin pasivare.

3. Avantaje

Formarea de acoperire egală și uniformă cât și buna acoperire la colțuri și muchii, chiar și la obiectele cu forme mai complicate prin:

- O bună acoperire în spațiile cu goluri sau greu accesibile
- Fără formarea de picături curgătoare sau galerii
- Protecția anticorozivă înaltă datorită ei rămânând o suprafață decorativă cu durabilitate mare.

4. Particularitatea suprafeței MACO

La deteriorări prin zgârieturi etc. apar la acoperirile KTL de până acum rapid urme de rugină roșie.

MACO aplică la elementele de oțel ce trebuiesc acoperite același strat de zinc ca la elementele de rotație și basculare. Așa după aceea se acoperă elementele cu lac acrilic. Stratul de zinc acoperă micile zgârieturi chiar și dacă zgârieturile ajung la stratul de bază.

Prin aceasta suprafața MACO îmbină avantajele a două tehnici de acoperire

- 1 strat KTL
- 2 fosfat de zinc
- 3 tablă subțire
- 4 fosfat de zinc

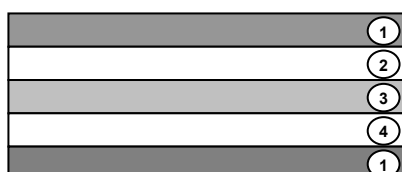



ELOXARE

1. Oxidarea electrolitică a aluminiului

Cu ajutorul curentului continuu sau alternativ se formează în procedeele anodice cu electroliti pe mînerelor de la ferestre și uși suprafețe:

dure

rezistente la uzură

rezistente la intemperii și

suprafețe oxidate decorative.

Suprafețele oxidate executate prin procedee comune sunt în stare pe baza structurii lor să preia soluții colorante de tip organic sau anorganic.

Prin aceasta este posibil să realizezi suprafețe din aluminiu în culori diferite. Deci se folosesc procedee cu soluții colorante în special la comenzi de suprafețe decorative.

Testările esențiale ale suprafețelor de oxidare anodică sunt stabilite în normele DIN 17611 și 17612. Măsurarea microscopică a grosimii stratelor se face conform DIN 50945.



1. Materialele

MACO prelucrează următoarele materiale:

Oțel

huse, zăvoare și diverse elemente mărunte se execută din benzi și profile din oțel aliat lamunat la rece

Zinc rafinat

Dintr-un aliaj valoros al zincului rafinat se produc prin turnare sub presiune, elemente de ânchidere, benzi și diverse alte elemente mici.

Aluminiu

Mânerele pentru uși și ferestre se produc dintr-un aliaj de aluminiu eloxabil.

2. Metodele

MACO folosește următoarele procedee pentru îmbunătățirea suprafețelor:

La elemente din oțel

- zincare și pasivare
- Acoperire KTL alb și negru

La elementele din aluminiu rafinat

- pasivare
- acoperire KTL

La elementele de aluminiu

- eloxare
- acoperire KTL

3. Procedeele

Zincare

Toate căptușelile din oțel snt prevăzute cu o acoperire electrolitică din zinc rafinat, dtratul are grosimi de 6 la 15 1/1000 mm.

Pasivarea respectiv cromarea.

Această acoperirese folosește pentru o protecție suplimentară împotriva coroziunii și pentru obținerea unei suprafațe decorative.Cromarea se chiamă în multe cazuri și pasivare, este vorba aici de douădenumiri pentru acelaș procedeu.



Pasivarea sau cromarea există în culorile albastru, verde olov, galben și negru. MACO pasivează în culorile galben și albastru.

Elementele din zinc rafinat se pasivează numai (de exemplu elementele de închidere) .

4. Avantajele

Straturi de zinc galvanice au avantajul că radiază și deteriorări ale stratului de anticoroziv de pînă la un mm , adică nu apăsă încă corozionează și materialul de bază , oțelul, este deja vizibil.

5. Sigilarea cu ceară

MACO are dezvoltat un procedeu ce permite sigilarea suplimentară a stratului de pasivare cu unul de ceară. Urmările acestei tratări suplimentare a suprafețelor sunt:

- **se dă posibilitatea unei protecții anticorozive mai mari decât cerută**
- **o mai bună posibilitate de alunecare**
- **o suprafață mai egală.**

Culorile ce bat în violet, ce apar des la pasivare aproape că nu mai există, de exemplu cromarea galbenă primește prin noua tratare a suprafețelor o culoare de alamă.

Acoperirile MACO la ora actuală se oferă în următoarele culori de pasivare:

1. galben-pasivat
2. Silver look (pasivare albastră modificată)

1. Sigilarea cu ceară (intră în pasivare)
2. Pasivare
- 3 strat de zinc rafinat 6 la 15 1/1000 mm.

MACO Declaratia De Garantie



MACO garantează...

prin apartenența la grupul asociației calității RAL închizători și ornamente de calitate supravegheată de o poziție neutrală și certificată după DIN EN ISO 9001:2000.

...o calitate a suprafeței ce depășește limitele cerute de către asociația calității RAL

...că la o montare și folosire profesională a ornamentelor noastre oscilo-batante, în interiorul timpului de garanție, nu apar ruperi la elementele portante cât și la cele montate în blat ale sistemului de deplasare și zăvorâre, dacă sunt îndeplinite demonstrabil toate premisele pentru această garanție.

..în caz de garanție se înlocuiește elementul gratis în termen de 10 ani de la data fabricării, dacă același element nu mai este disponibil cu unul cu aceeași funcțiune. Data de producere este inscripționată vizibil la toate elementele relevante pentru garanție. Dacă data nu este vizibilă se ia în considerare ziua montării. O altă înlocuire de costuri este exclusă.

Noi vă oferim suplimentar...

Instrucțiuni de îngrijire și informații de folosire sub forma de de elemente agățate de mânerul geamului, sau de acțibilduri, respectiv toate celelalte materiale informaționale ce sunt necesare conform obligativității informaționale.

...ajutor la emiterea indicațiilor proprii de întreținere respectiv a pașapoartelor de garanție.

...Instruire gratuită pentru personalul prevăzut pentru întreținere

Premizele pentru garanție:

- a) Folosirea corespunzătoare RAL respectiv montarea ornamentelor noastre și respectarea tuturor indicațiilor de prelucrare cât și luarea în considerare a tuturor limitărilor de dimensiuni și greutate.
- b) Îndeplinirea tuturor obligațiilor de instruire a utilizatorului ferestrei.
- c) Utilizatorul ferestrei este atenționat ca în caz de deteriorări vizibile din cauza furtunii sau asemenea trebuie anunțat neîntârziat producătorul ferestrei.
- d) Întreținere demonstrabilă
 - Elemente de siguranță relevante se verifică anual de stabilitate poziției și uzură.
 - reungerea tuturor elementelor de închidere.
 - La fiecare 5 ani însărcinarea cu întreținerea a fabricantului ferestrelor.

Toate lucrările de întreținere se execută corespunzător cu instrucțiunile de deservire și întreținere MACO, și se consemnează într-un caiet de evidență întreținerilor sau a unui pașaport de garanție, astfel încât în fiecare moment să existe dovada întreținerii efectuate.



Deschidere Oscilo - Batanta

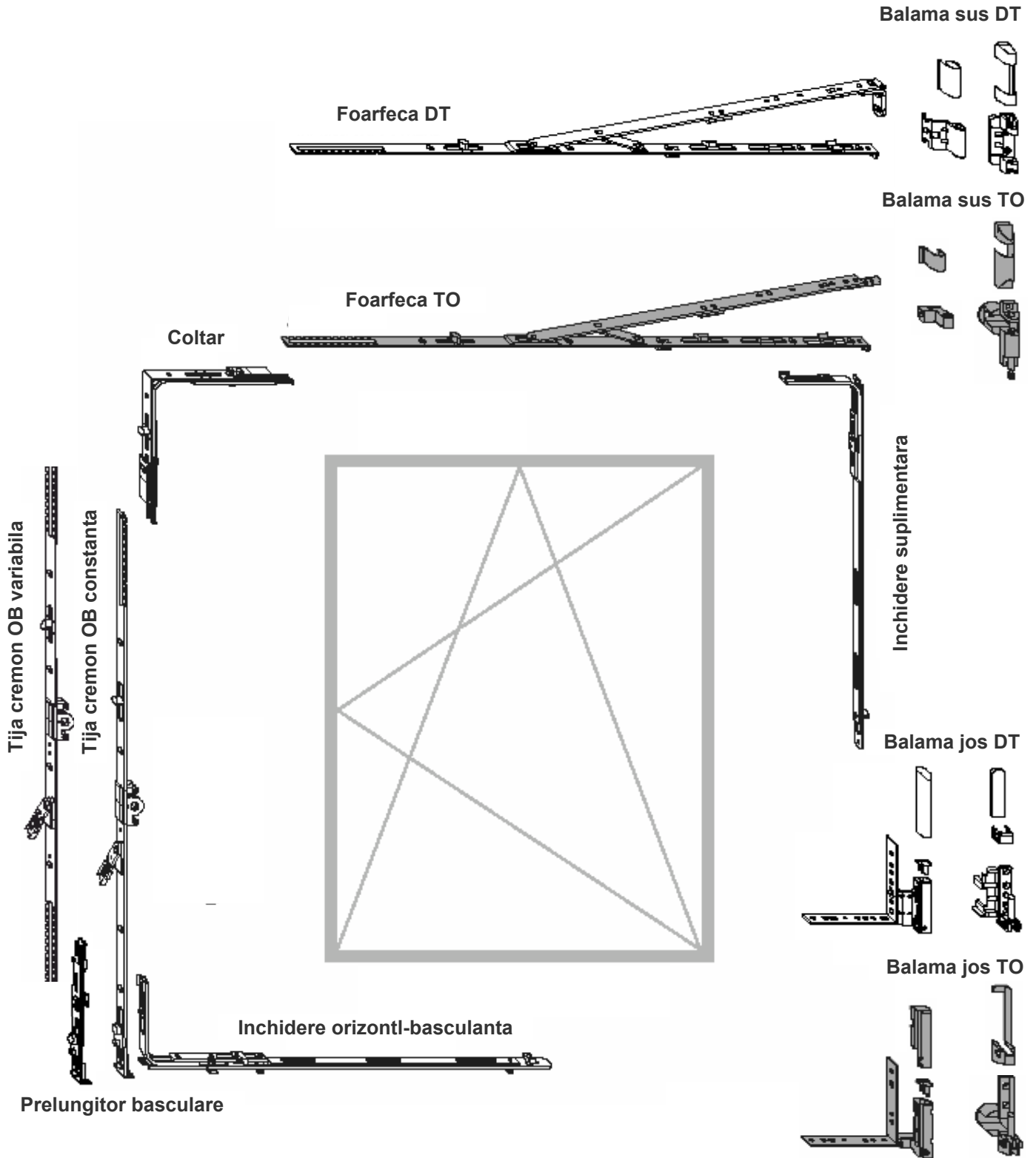

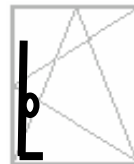





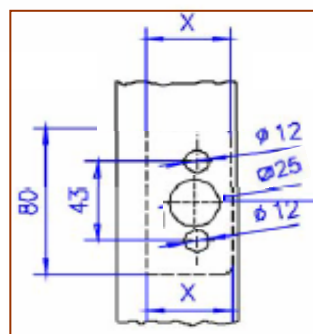
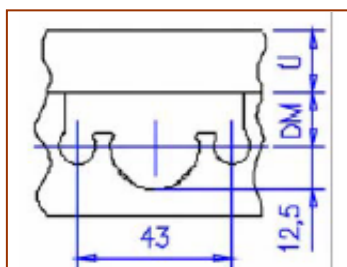
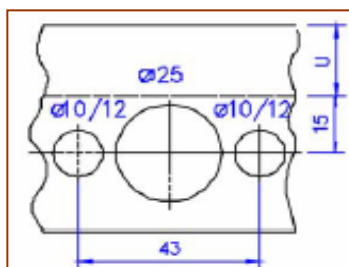
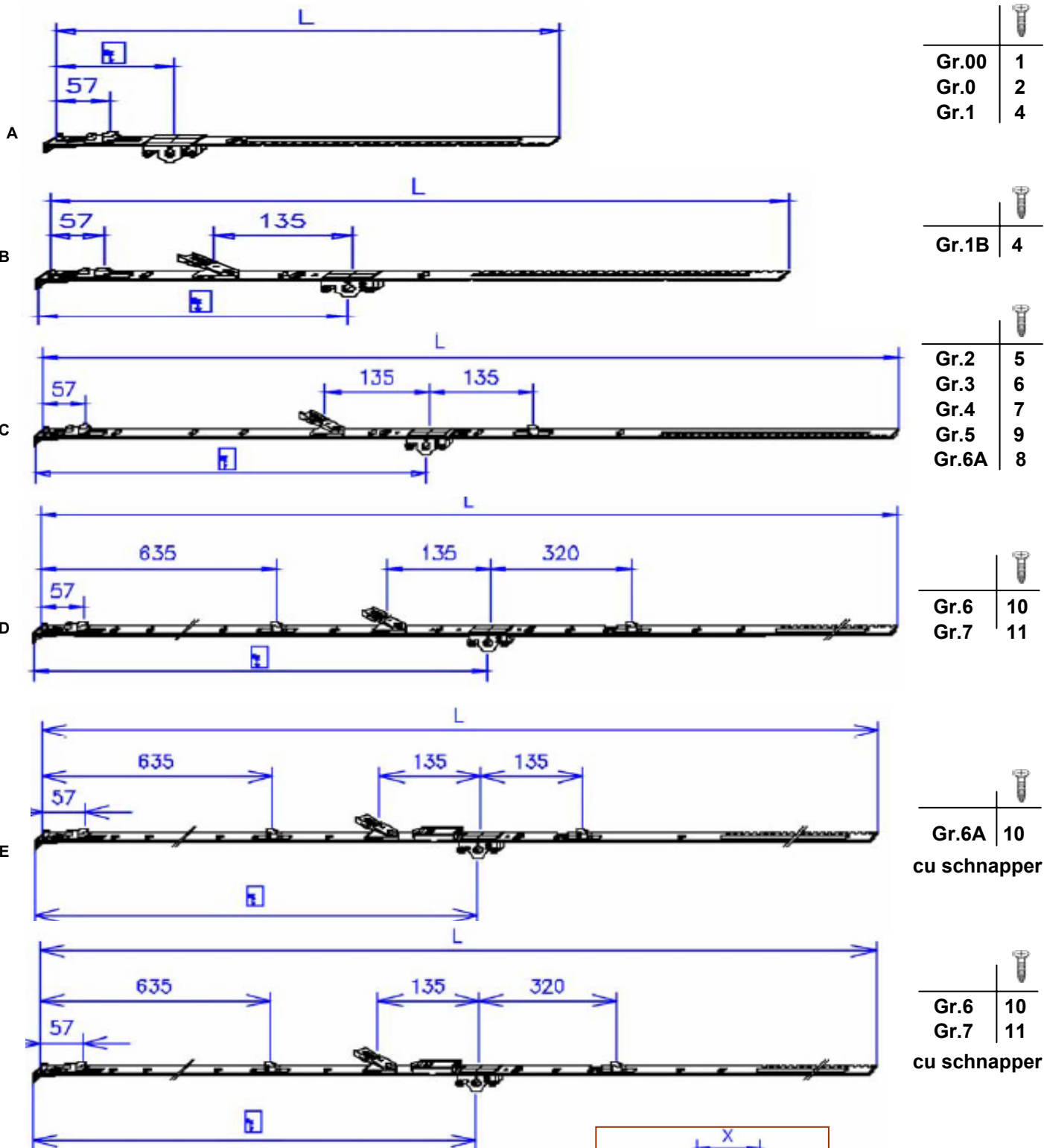

Informatii tehnice

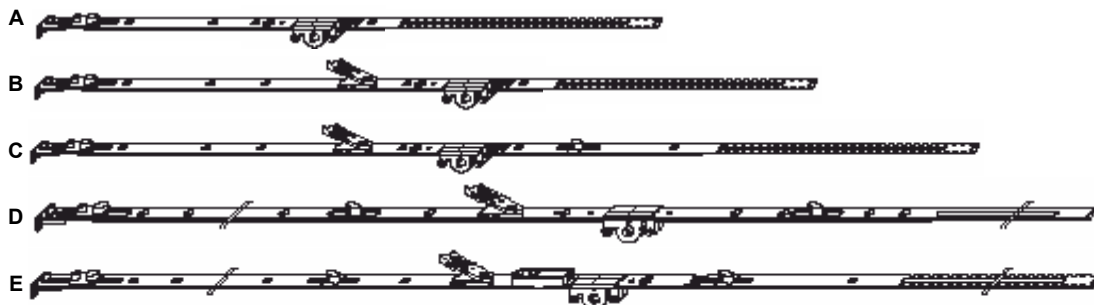
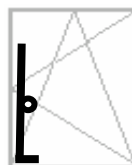
Tija cremon OB constanta, DM 15 mm



$x = DM + 12,5 \text{ mm}$



	Argintiu N 	Tija cremon OB constanta	L			DM	
A	52400	Gr. 00 pentru B & OB	490	120	370 - 620	15	20
	52401	Gr. 0	540	170	430 - 680	15	20
	52402	Gr. 1	720	300	600 - 800	15	20
B	52403	Gr. 1B cu siguranta	720	300	600 - 800	15	20
C	52404	Gr. 2	910	400	801 - 1000	15	20
	52405	Gr. 3	1110	500	1001 - 1250	15	20
D	52406	Gr. 4	1360	600	1251 - 1500	15	10
	52407	Gr. 5	1610	700	1501 - 1750	15	10
	52408	Gr. 6	1960	1050	1851 - 2100	15	10
E	55158	Gr. 6A	1680	1050	1661 - 1850	15	10
	52410	Gr. 7	2210	1050	2101 - 2350	15	10
	52844	Gr. 6 cu schnapper	1960	1050	1851 - 2100	15	10
	52409	Gr. 6A	1680	1050	1661 - 1850	15	10
	52411	Gr. 7	2210	1050	2101 - 2350	15	10



	Dimensiuni											
Gr.00	19,5											
Gr.0	19,5	100										
Gr.1	19,5	100	232,5	370								
Gr.1B	19,5	100	232,5	370								
Gr.2A	19,5	100	332,5	470	568							
Gr.3	19,5	100	265	432,5	570	754						
Gr.4	19,5	100	320	532,5	670	840	1004					
Gr.5	19,5	100	280	460	632,5	770	930	1080	1254			
Gr.6	19,5	100	320	540	760	982,5	1153	1338	1455	1599		
Gr.6A	19,5	100	320	540	760	982,5	1153	1319				
Gr.7	19,5	100	320	540	760	982,5	1153	1338	1493	1673	1854	

MACO MULTI TREND

Informatii tehnice

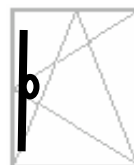

Tija cremon OB variabila, DM 15 mm

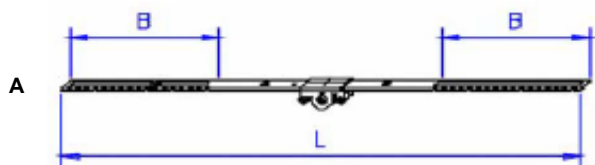

Gr.1	2
Gr.2	2

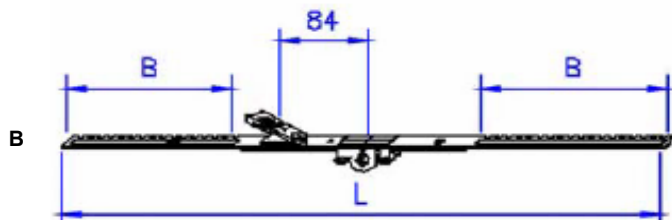

Gr.1A	2

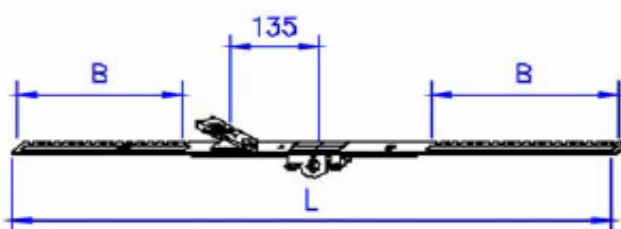

Gr.2A	2

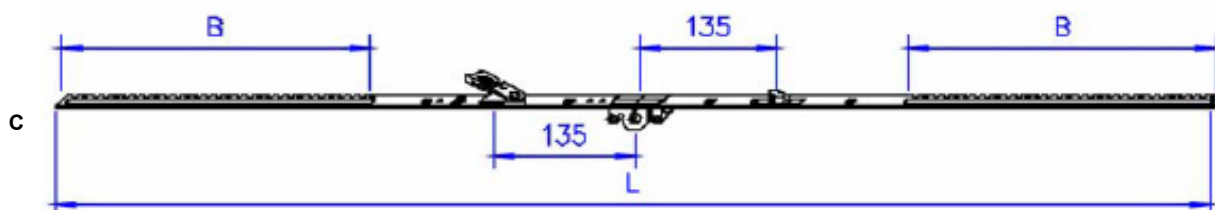

Gr.3	4
Gr.4	6

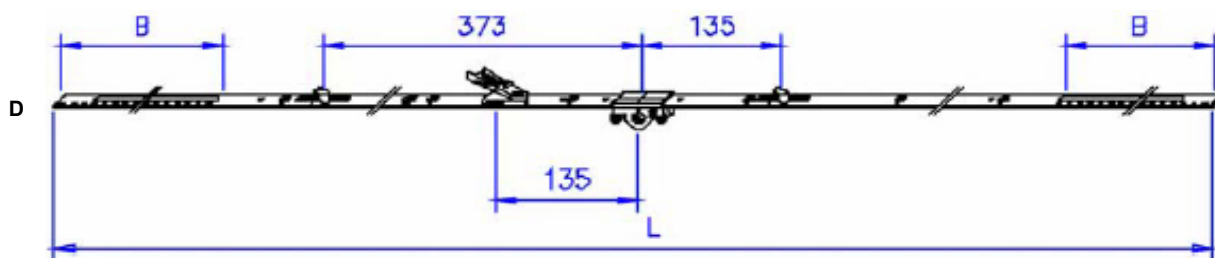



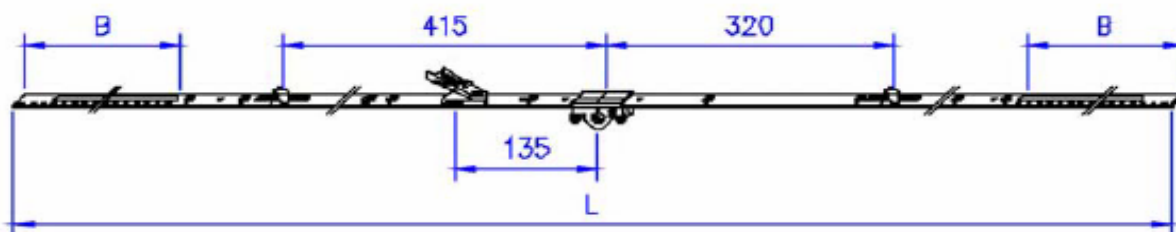

Gr.4A	6

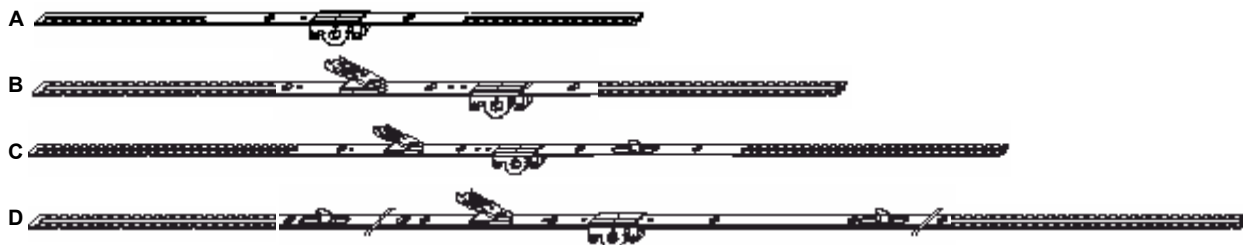
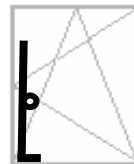

Gr.5	8

	Gr.1		Gr.1A		Gr.2A		Gr.3		Gr.4		Gr.4A		Gr.5	
Gr.1														
Gr.1A					70									
Gr.2A					67,5	70								
Gr.3			207	67,5	70	207								
Gr.4		407	250	67,5	103	250	407							
Gr.5	649	483	272	67,5	103	288	451	639						



	Argintiu N ^o	Tija cremon OB variabila	L	B		DM	
A	52422	Gr. 1 pentru B & OB	350	92	500 - 650	15	20
	52966	Gr. 2 pentru B & OB	600	160	651 - 900	15	20
B	52423	Gr. 1A cu siguranta	580	170	600 - 900	15	20
	52424	Gr. 2A cu siguranta	600	72	750 - 900	15	20
C	52425	Gr. 3 cu siguranta	1125	290	901 - 1300	15	20
	52426	Gr. 4 cu siguranta	1525	290	1301 - 1800	15	10
D	54952	Gr. 4A cu siguranta	1525	290	1301 - 1800	15	10
	52427	Gr. 5 cu siguranta	2010	290	1801 - 2350	15	10

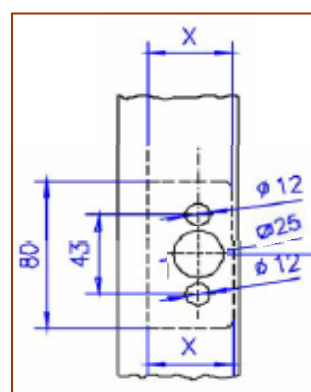
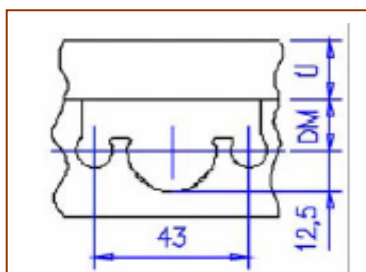
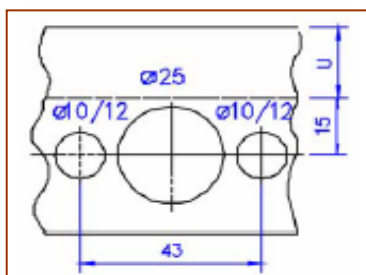

$$x = DM + 12,5 \text{ mm}$$

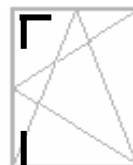





Informatii tehnice

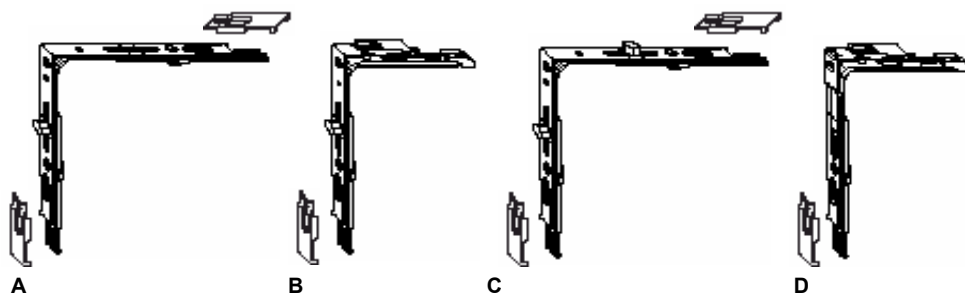
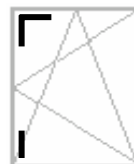



Coltare cu placutele de legatura separate

<table border="1"> <tr> <td style="width: 50px;">Tip A</td> <td style="width: 20px;"> </td> <td style="width: 20px;">4</td> </tr> </table>	Tip A		4	<table border="1"> <tr> <td style="width: 50px;">Tip B</td> <td style="width: 20px;"> </td> <td style="width: 20px;">3</td> </tr> </table>	Tip B		3	<table border="1"> <tr> <td style="width: 50px;">Tip C</td> <td style="width: 20px;"> </td> <td style="width: 20px;">4</td> </tr> </table>	Tip C		4	<table border="1"> <tr> <td style="width: 50px;">Tip D</td> <td style="width: 20px;"> </td> <td style="width: 20px;">3</td> </tr> </table>	Tip D		3
Tip A		4													
Tip B		3													
Tip C		4													
Tip D		3													
<table border="1"> <tr> <td style="width: 50px;"> </td> <td style="width: 20px;"> </td> <td style="width: 20px;">4</td> </tr> </table>			4	<table border="1"> <tr> <td style="width: 50px;"> </td> <td style="width: 20px;"> </td> <td style="width: 20px;">3</td> </tr> </table>			3	<table border="1"> <tr> <td style="width: 50px;"> </td> <td style="width: 20px;"> </td> <td style="width: 20px;">4</td> </tr> </table>			4	<table border="1"> <tr> <td style="width: 50px;"> </td> <td style="width: 20px;"> </td> <td style="width: 20px;">3</td> </tr> </table>			3
		4													
		3													
		4													
		3													
<table border="1"> <tr> <td style="width: 50px;"> </td> <td style="width: 20px;"> </td> <td style="width: 20px;">4</td> </tr> </table>			4	<table border="1"> <tr> <td style="width: 50px;"> </td> <td style="width: 20px;"> </td> <td style="width: 20px;">3</td> </tr> </table>			3	<table border="1"> <tr> <td style="width: 50px;"> </td> <td style="width: 20px;"> </td> <td style="width: 20px;">4</td> </tr> </table>			4	<table border="1"> <tr> <td style="width: 50px;"> </td> <td style="width: 20px;"> </td> <td style="width: 20px;">3</td> </tr> </table>			3
		4													
		3													
		4													
		3													
<table border="1"> <tr> <td style="width: 50px;"> </td> <td style="width: 20px;"> </td> <td style="width: 20px;">4</td> </tr> </table>			4	<table border="1"> <tr> <td style="width: 50px;"> </td> <td style="width: 20px;"> </td> <td style="width: 20px;">3</td> </tr> </table>			3	<table border="1"> <tr> <td style="width: 50px;"> </td> <td style="width: 20px;"> </td> <td style="width: 20px;">4</td> </tr> </table>			4	<table border="1"> <tr> <td style="width: 50px;"> </td> <td style="width: 20px;"> </td> <td style="width: 20px;">3</td> </tr> </table>			3
		4													
		3													
		4													
		3													
<table border="1"> <tr> <td style="width: 50px;"> </td> <td style="width: 20px;"> </td> <td style="width: 20px;">4</td> </tr> </table>			4	<table border="1"> <tr> <td style="width: 50px;"> </td> <td style="width: 20px;"> </td> <td style="width: 20px;">3</td> </tr> </table>			3	<table border="1"> <tr> <td style="width: 50px;"> </td> <td style="width: 20px;"> </td> <td style="width: 20px;">4</td> </tr> </table>			4	<table border="1"> <tr> <td style="width: 50px;"> </td> <td style="width: 20px;"> </td> <td style="width: 20px;">3</td> </tr> </table>			3
		4													
		3													
		4													
		3													
<table border="1"> <tr> <td style="width: 50px;"> </td> <td style="width: 20px;"> </td> <td style="width: 20px;">4</td> </tr> </table>			4	<table border="1"> <tr> <td style="width: 50px;"> </td> <td style="width: 20px;"> </td> <td style="width: 20px;">3</td> </tr> </table>			3	<table border="1"> <tr> <td style="width: 50px;"> </td> <td style="width: 20px;"> </td> <td style="width: 20px;">4</td> </tr> </table>			4	<table border="1"> <tr> <td style="width: 50px;"> </td> <td style="width: 20px;"> </td> <td style="width: 20px;">3</td> </tr> </table>			3
		4													
		3													
		4													
		3													
<table border="1"> <tr> <td style="width: 50px;"> </td> <td style="width: 20px;"> </td> <td style="width: 20px;">4</td> </tr> </table>			4	<table border="1"> <tr> <td style="width: 50px;"> </td> <td style="width: 20px;"> </td> <td style="width: 20px;">3</td> </tr> </table>			3	<table border="1"> <tr> <td style="width: 50px;"> </td> <td style="width: 20px;"> </td> <td style="width: 20px;">4</td> </tr> </table>			4	<table border="1"> <tr> <td style="width: 50px;"> </td> <td style="width: 20px;"> </td> <td style="width: 20px;">3</td> </tr> </table>			3
		4													
		3													
		4													
		3													
<table border="1"> <tr> <td style="width: 50px;"> </td> <td style="width: 20px;"> </td> <td style="width: 20px;">4</td> </tr> </table>			4	<table border="1"> <tr> <td style="width: 50px;"> </td> <td style="width: 20px;"> </td> <td style="width: 20px;">3</td> </tr> </table>			3	<table border="1"> <tr> <td style="width: 50px;"> </td> <td style="width: 20px;"> </td> <td style="width: 20px;">4</td> </tr> </table>			4	<table border="1"> <tr> <td style="width: 50px;"> </td> <td style="width: 20px;"> </td> <td style="width: 20px;">3</td> </tr> </table>			3
		4													
		3													
		4													
		3													
<table border="1"> <tr> <td style="width: 50px;"> </td> <td style="width: 20px;"> </td> <td style="width: 20px;">4</td> </tr> </table>			4	<table border="1"> <tr> <td style="width: 50px;"> </td> <td style="width: 20px;"> </td> <td style="width: 20px;">3</td> </tr> </table>			3	<table border="1"> <tr> <td style="width: 50px;"> </td> <td style="width: 20px;"> </td> <td style="width: 20px;">4</td> </tr> </table>			4	<table border="1"> <tr> <td style="width: 50px;"> </td> <td style="width: 20px;"> </td> <td style="width: 20px;">3</td> </tr> </table>			3
		4													
		3													
		4													
		3													
<table border="1"> <tr> <td style="width: 50px;"> </td> <td style="width: 20px;"> </td> <td style="width: 20px;">4</td> </tr> </table>			4	<table border="1"> <tr> <td style="width: 50px;"> </td> <td style="width: 20px;"> </td> <td style="width: 20px;">3</td> </tr> </table>			3	<table border="1"> <tr> <td style="width: 50px;"> </td> <td style="width: 20px;"> </td> <td style="width: 20px;">4</td> </tr> </table>			4	<table border="1"> <tr> <td style="width: 50px;"> </td> <td style="width: 20px;"> </td> <td style="width: 20px;">3</td> </tr> </table>			3
		4													
		3													
		4													
		3													
<table border="1"> <tr> <td style="width: 50px;"> </td> <td style="width: 20px;"> </td> <td style="width: 20px;">4</td> </tr> </table>			4	<table border="1"> <tr> <td style="width: 50px;"> </td> <td style="width: 20px;"> </td> <td style="width: 20px;">3</td> </tr> </table>			3	<table border="1"> <tr> <td style="width: 50px;"> </td> <td style="width: 20px;"> </td> <td style="width: 20px;">4</td> </tr> </table>			4	<table border="1"> <tr> <td style="width: 50px;"> </td> <td style="width: 20px;"> </td> <td style="width: 20px;">3</td> </tr> </table>			3
		4													
		3													
		4													
		3													
<table border="1"> <tr> <td style="width: 50px;"> </td> <td style="width: 20px;"> </td> <td style="width: 20px;">4</td> </tr> </table>			4	<table border="1"> <tr> <td style="width: 50px;"> </td> <td style="width: 20px;"> </td> <td style="width: 20px;">3</td> </tr> </table>			3	<table border="1"> <tr> <td style="width: 50px;"> </td> <td style="width: 20px;"> </td> <td style="width: 20px;">4</td> </tr> </table>			4	<table border="1"> <tr> <td style="width: 50px;"> </td> <td style="width: 20px;"> </td> <td style="width: 20px;">3</td> </tr> </table>			3
		4													
		3													
		4													
		3													
<table border="1"> <tr> <td style="width: 50px;"> </td> <td style="width: 20px;"> </td> <td style="width: 20px;">4</td> </tr> </table>			4	<table border="1"> <tr> <td style="width: 50px;"> </td> <td style="width: 20px;"> </td> <td style="width: 20px;">3</td> </tr> </table>			3	<table border="1"> <tr> <td style="width: 50px;"> </td> <td style="width: 20px;"> </td> <td style="width: 20px;">4</td> </tr> </table>			4	<table border="1"> <tr> <td style="width: 50px;"> </td> <td style="width: 20px;"> </td> <td style="width: 20px;">3</td> </tr> </table>			3
		4													
		3													
		4													
		3													
<table border="1"> <tr> <td style="width: 50px;"> </td> <td style="width: 20px;"> </td> <td style="width: 20px;">4</td> </tr> </table>			4	<table border="1"> <tr> <td style="width: 50px;"> </td> <td style="width: 20px;"> </td> <td style="width: 20px;">3</td> </tr> </table>			3	<table border="1"> <tr> <td style="width: 50px;"> </td> <td style="width: 20px;"> </td> <td style="width: 20px;">4</td> </tr> </table>			4	<table border="1"> <tr> <td style="width: 50px;"> </td> <td style="width: 20px;"> </td> <td style="width: 20px;">3</td> </tr> </table>			3
		4													
		3													
		4													
		3													
<table border="1"> <tr> <td style="width: 50px;"> </td> <td style="width: 20px;"> </td> <td style="width: 20px;">4</td> </tr> </table>			4	<table border="1"> <tr> <td style="width: 50px;"> </td> <td style="width: 20px;"> </td> <td style="width: 20px;">3</td> </tr> </table>			3	<table border="1"> <tr> <td style="width: 50px;"> </td> <td style="width: 20px;"> </td> <td style="width: 20px;">4</td> </tr> </table>			4	<table border="1"> <tr> <td style="width: 50px;"> </td> <td style="width: 20px;"> </td> <td style="width: 20px;">3</td> </tr> </table>			3
		4													
		3													
		4													
		3													
<table border="1"> <tr> <td style="width: 50px;"> </td> <td style="width: 20px;"> </td> <td style="width: 20px;">4</td> </tr> </table>			4	<table border="1"> <tr> <td style="width: 50px;"> </td> <td style="width: 20px;"> </td> <td style="width: 20px;">3</td> </tr> </table>			3	<table border="1"> <tr> <td style="width: 50px;"> </td> <td style="width: 20px;"> </td> <td style="width: 20px;">4</td> </tr> </table>			4	<table border="1"> <tr> <td style="width: 50px;"> </td> <td style="width: 20px;"> </td> <td style="width: 20px;">3</td> </tr> </table>			3
		4													
		3													
		4													
		3													
<table border="1"> <tr> <td style="width: 50px;"> </td> <td style="width: 20px;"> </td> <td style="width: 20px;">4</td> </tr> </table>			4	<table border="1"> <tr> <td style="width: 50px;"> </td> <td style="width: 20px;"> </td> <td style="width: 20px;">3</td> </tr> </table>			3	<table border="1"> <tr> <td style="width: 50px;"> </td> <td style="width: 20px;"> </td> <td style="width: 20px;">4</td> </tr> </table>			4	<table border="1"> <tr> <td style="width: 50px;"> </td> <td style="width: 20px;"> </td> <td style="width: 20px;">3</td> </tr> </table>			3
		4													
		3													
		4													
		3													
<table border="1"> <tr> <td style="width: 50px;"> </td> <td style="width: 20px;"> </td> <td style="width: 20px;">4</td> </tr> </table>			4	<table border="1"> <tr> <td style="width: 50px;"> </td> <td style="width: 20px;"> </td> <td style="width: 20px;">3</td> </tr> </table>			3	<table border="1"> <tr> <td style="width: 50px;"> </td> <td style="width: 20px;"> </td> <td style="width: 20px;">4</td> </tr> </table>			4	<table border="1"> <tr> <td style="width: 50px;"> </td> <td style="width: 20px;"> </td> <td style="width: 20px;">3</td> </tr> </table>			3
		4													
		3													
		4													
		3													
<table border="1"> <tr> <td style="width: 50px;"> </td> <td style="width: 20px;"> </td> <td style="width: 20px;">4</td> </tr> </table>			4	<table border="1"> <tr> <td style="width: 50px;"> </td> <td style="width: 20px;"> </td> <td style="width: 20px;">3</td> </tr> </table>			3	<table border="1"> <tr> <td style="width: 50px;"> </td> <td style="width: 20px;"> </td> <td style="width: 20px;">4</td> </tr> </table>			4	<table border="1"> <tr> <td style="width: 50px;"> </td> <td style="width: 20px;"> </td> <td style="width: 20px;">3</td> </tr> </table>			3
		4													
		3													
		4													
		3													
<table border="1"> <tr> <td style="width: 50px;"> </td> <td style="width: 20px;"> </td> <td style="width: 20px;">4</td> </tr> </table>			4	<table border="1"> <tr> <td style="width: 50px;"> </td> <td style="width: 20px;"> </td> <td style="width: 20px;">3</td> </tr> </table>			3	<table border="1"> <tr> <td style="width: 50px;"> </td> <td style="width: 20px;"> </td> <td style="width: 20px;">4</td> </tr> </table>			4	<table border="1"> <tr> <td style="width: 50px;"> </td> <td style="width: 20px;"> </td> <td style="width: 20px;">3</td> </tr> </table>			3
		4													
		3													
		4													
		3													
<table border="1"> <tr> <td style="width: 50px;"> </td> <td style="width: 20px;"> </td> <td style="width: 20px;">4</td> </tr> </table>			4	<table border="1"> <tr> <td style="width: 50px;"> </td> <td style="width: 20px;"> </td> <td style="width: 20px;">3</td> </tr> </table>			3	<table border="1"> <tr> <td style="width: 50px;"> </td> <td style="width: 20px;"> </td> <td style="width: 20px;">4</td> </tr> </table>			4	<table border="1"> <tr> <td style="width: 50px;"> </td> <td style="width: 20px;"> </td> <td style="width: 20px;">3</td> </tr> </table>			3
		4													
		3													
		4													
		3													
<table border="1"> <tr> <td style="width: 50px;"> </td> <td style="width: 20px;"> </td> <td style="width: 20px;">4</td> </tr> </table>			4	<table border="1"> <tr> <td style="width: 50px;"> </td> <td style="width: 20px;"> </td> <td style="width: 20px;">3</td> </tr> </table>			3	<table border="1"> <tr> <td style="width: 50px;"> </td> <td style="width: 20px;"> </td> <td style="width: 20px;">4</td> </tr> </table>			4	<table border="1"> <tr> <td style="width: 50px;"> </td> <td style="width: 20px;"> </td> <td style="width: 20px;">3</td> </tr> </table>			3
		4													
		3													
		4													
		3													
<table border="1"> <tr> <td style="width: 50px;"> </td> <td style="width: 20px;"> </td> <td style="width: 20px;">4</td> </tr> </table>			4	<table border="1"> <tr> <td style="width: 50px;"> </td> <td style="width: 20px;"> </td> <td style="width: 20px;">3</td> </tr> </table>			3	<table border="1"> <tr> <td style="width: 50px;"> </td> <td style="width: 20px;"> </td> <td style="width: 20px;">4</td> </tr> </table>			4	<table border="1"> <tr> <td style="width: 50px;"> </td> <td style="width: 20px;"> </td> <td style="width: 20px;">3</td> </tr> </table>			3
		4													
		3													
		4													
		3													
<table border="1"> <tr> <td style="width: 50px;"> </td> <td style="width: 20px;"> </td> <td style="width: 20px;">4</td> </tr> </table>			4	<table border="1"> <tr> <td style="width: 50px;"> </td> <td style="width: 20px;"> </td> <td style="width: 20px;">3</td> </tr> </table>			3	<table border="1"> <tr> <td style="width: 50px;"> </td> <td style="width: 20px;"> </td> <td style="width: 20px;">4</td> </tr> </table>			4	<table border="1"> <tr> <td style="width: 50px;"> </td> <td style="width: 20px;"> </td> <td style="width: 20px;">3</td> </tr> </table>			3
		4													
		3													
		4													
		3													
<table border="1"> <tr> <td style="width: 50px;"> </td> <td style="width: 20px;"> </td> <td style="width: 20px;">4</td> </tr> </table>			4	<table border="1"> <tr> <td style="width: 50px;"> </td> <td style="width: 20px;"> </td> <td style="width: 20px;">3</td> </tr> </table>			3	<table border="1"> <tr> <td style="width: 50px;"> </td> <td style="width: 20px;"> </td> <td style="width: 20px;">4</td> </tr> </table>			4	<table border="1"> <tr> <td style="width: 50px;"> </td> <td style="width: 20px;"> </td> <td style="width: 20px;">3</td> </tr> </table>			3
		4													
		3													
		4													
		3													
<table border="1"> <tr> <td style="width: 50px;"> </td> <td style="width: 20px;"> </td> <td style="width: 20px;">4</td> </tr> </table>			4	<table border="1"> <tr> <td style="width: 50px;"> </td> <td style="width: 20px;"> </td> <td style="width: 20px;">3</td> </tr> </table>			3	<table border="1"> <tr> <td style="width: 50px;"> </td> <td style="width: 20px;"> </td> <td style="width: 20px;">4</td> </tr> </table>			4	<table border="1"> <tr> <td style="width: 50px;"> </td> <td style="width: 20px;"> </td> <td style="width: 20px;">3</td> </tr> </table>			3
		4													
		3													
		4													
		3													
<table border="1"> <tr> <td style="width: 50px;"> </td> <td style="width: 20px;"> </td> <td style="width: 20px;">4</td> </tr> </table>			4	<table border="1"> <tr> <td style="width: 50px;"> </td> <td style="width: 20px;"> </td> <td style="width: 20px;">3</td> </tr> </table>			3	<table border="1"> <tr> <td style="width: 50px;"> </td> <td style="width: 20px;"> </td> <td style="width: 20px;">4</td> </tr> </table>			4	<table border="1"> <tr> <td style="width: 50px;"> </td> <td style="width: 20px;"> </td> <td style="width: 20px;">3</td> </tr> </table>			3
		4													
		3													
		4													
		3													
<table border="1"> <tr> <td style="width: 50px;"> </td> <td style="width: 20px;"> </td> <td style="width: 20px;">4</td> </tr> </table>			4	<table border="1"> <tr> <td style="width: 50px;"> </td> <td style="width: 20px;"> </td> <td style="width: 20px;">3</td> </tr> </table>			3	<table border="1"> <tr> <td style="width: 50px;"> </td> <td style="width: 20px;"> </td> <td style="width: 20px;">4</td> </tr> </table>			4	<table border="1"> <tr> <td style="width: 50px;"> </td> <td style="width: 20px;"> </td> <td style="width: 20px;">3</td> </tr> </table>			3
		4													
		3													
		4													
		3													
<table border="1"> <tr> <td style="width: 50px;"> </td> <td style="width: 20px;"> </td> <td style="width: 20px;">4</td> </tr> </table>			4	<table border="1"> <tr> <td style="width: 50px;"> </td> <td style="width: 20px;"> </td> <td style="width: 20px;">3</td> </tr> </table>			3	<table border="1"> <tr> <td style="width: 50px;"> </td> <td style="width: 20px;"> </td> <td style="width: 20px;">4</td> </tr> </table>			4	<table border="1"> <tr> <td style="width: 50px;"> </td> <td style="width: 20px;"> </td> <td style="width: 20px;">3</td> </tr> </table>			3
		4													
		3													
		4													
		3													
<table border="1"> <tr> <td style="width: 50px;"> </td> <td style="width: 20px;"> </td> <td style="width: 20px;">4</td> </tr> </table>			4	<table border="1"> <tr> <td style="width: 50px;"> </td> <td style="width: 20px;"> </td> <td style="width: 20px;">3</td> </tr> </table>			3	<table border="1"> <tr> <td style="width: 50px;"> </td> <td style="width: 20px;"> </td> <td style="width: 20px;">4</td> </tr> </table>			4	<table border="1"> <tr> <td style="width: 50px;"> </td> <td style="width: 20px;"> </td> <td style="width: 20px;">3</td> </tr> </table>			3
		4													
		3													
		4													
		3													
<table border="1"> <tr> <td style="width: 50px;"> </td> <td style="width: 20px;"> </td> <td style="width: 20px;">4</td> </tr> </table>			4	<table border="1"> <tr> <td style="width: 50px;"> </td> <td style="width: 20px;"> </td> <td style="width: 20px;">3</td> </tr> </table>			3	<table border="1"> <tr> <td style="width: 50px;"> </td> <td style="width: 20px;"> </td> <td style="width: 20px;">4</td> </tr> </table>			4	<table border="1"> <tr> <td style="width: 50px;"> </td> <td style="width: 20px;"> </td> <td style="width: 20px;">3</td> </tr> </table>			3
		4													
		3													
		4													
		3													
<table border="1"> <tr> <td style="width: 50px;"> </td> <td style="width: 20px;"> </td> <td style="width: 20px;">4</td> </tr> </table>			4	<table border="1"> <tr> <td style="width: 50px;"> </td> <td style="width: 20px;"> </td> <td style="width: 20px;">3</td> </tr> </table>			3	<table border="1"> <tr> <td style="width: 50px;"> </td> <td style="width: 20px;"> </td> <td style="width: 20px;">4</td> </tr> </table>			4	<table border="1"> <tr> <td style="width: 50px;"> </td> <td style="width: 20px;"> </td> <td style="width: 20px;">3</td> </tr> </table>			3
		4													
		3													
		4													
		3													
<table border="1"> <tr> <td style="width: 50px;"> </td> <td style="width: 20px;"> </td> <td style="width: 20px;">4</td> </tr> </table>			4	<table border="1"> <tr> <td style="width: 50px;"> </td> <td style="width: 20px;"> </td> <td style="width: 20px;">3</td> </tr> </table>			3	<table border="1"> <tr> <td style="width: 50px;"> </td> <td style="width: 20px;"> </td> <td style="width: 20px;">4</td> </tr> </table>			4	<table border="1"> <tr> <td style="width: 50px;"> </td> <td style="width: 20px;"> </td> <td style="width: 20px;">3</td> </tr> </table>			3
		4													
		3													
		4													
		3													
<table border="1"> <tr> <td style="width: 50px;"> </td> <td style="width: 20px;"> </td> <td style="width: 20px;">4</td> </tr> </table>			4	<table border="1"> <tr> <td style="width: 50px;"> </td> <td style="width: 20px;"> </td> <td style="width: 20px;">3</td> </tr> </table>			3	<table border="1"> <tr> <td style="width: 50px;"> </td> <td style="width: 20px;"> </td> <td style="width: 20px;">4</td> </tr> </table>			4	<table border="1"> <tr> <td style="width: 50px;"> </td> <td style="width: 20px;"> </td> <td style="width: 20px;">3</td> </tr> </table>			3
		4													
		3													
		4													
		3													
<table border="1"> <tr> <td style="width: 50px;"> </td> <td style="width: 20px;"> </td> <td style="width: 20px;">4</td> </tr> </table>			4	<table border="1"> <tr> <td style="width: 50px;"> </td> <td style="width: 20px;"> </td> <td style="width: 20px;">3</td> </tr> </table>			3	<table border="1"> <tr> <td style="width: 50px;"> </td> <td style="width: 20px;"> </td> <td style="width: 20px;">4</td> </tr> </table>			4	<table border="1"> <tr> <td style="width: 50px;"> </td> <td style="width: 20px;"> </td> <td style="width: 20px;">3</td> </tr> </table>			3
		4													
		3													
		4													
		3													
<table border="1"> <tr> <td style="width: 50px;"> </td> </tr></table>															

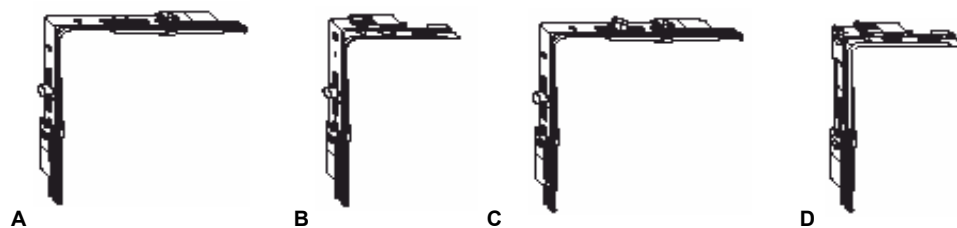



	Argintiu N ₁₀	Coltar cu placutele de legatura separate			
A	52513	egal cu 1 rola de inchidere	400 - 1650	370 - 2350	50
B	52514	inegal cu 1 rola de inchidere	280 - 650	370 - 2350	50
C	52515	egal cu 2 role de inchidere	400 - 1400	370 - 2350	50
D	52516	inegal cu tija de inchidere	280 - 650	370 - 2350	50

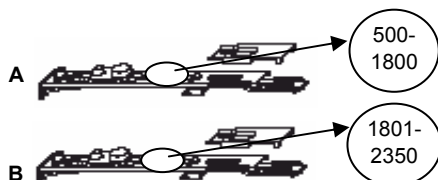

	Argintiu N ₁₀	Coltar cu placutele de legatura premontate			
A	55907	egal cu 1 rola de inchidere	400 - 1650	370 - 2350	50
B	54592	inegal cu 1 rola de inchidere	280 - 650	370 - 2350	50
C	55876	egal cu 2 role de inchidere	400 - 1400	370 - 2350	50
D	55877	inegal cu tija de inchidere	280 - 650	370 - 2350	50



	Argintiu N ₁₀	Prelungitor basculare		
A	52432	pt. ferestre	500 - 1800	20
B	52433	pt. usi-balcon	1801 - 2350	20



Informatii tehnice

Accesorii:

Prelungitor



250 mm	3

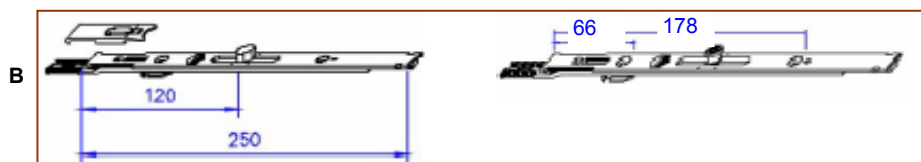

250 mm	3

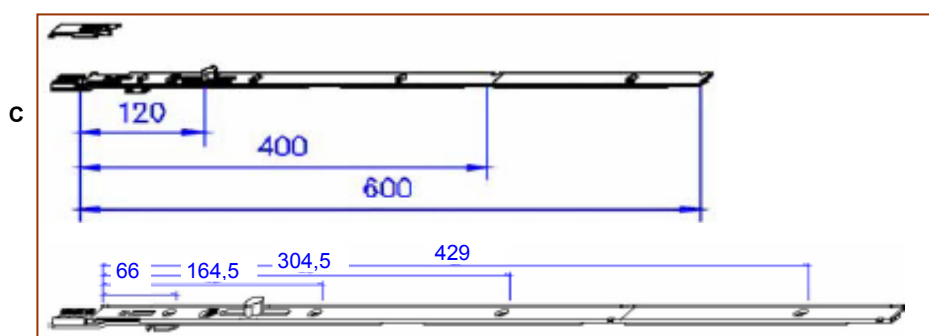

400/600 mm	5

Schnapper - Rola bila

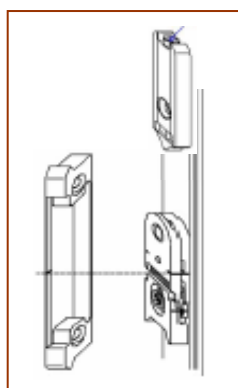
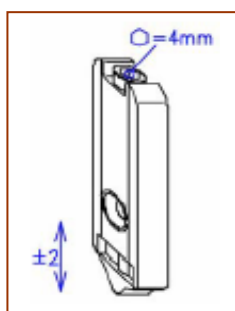

schnapper	1

Blocator



blocator	4

Foarfece a-2-a

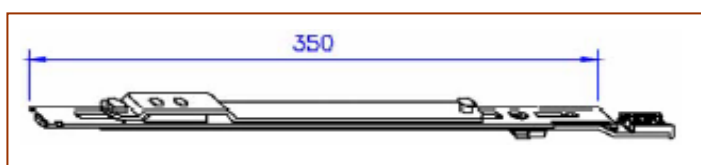





350 mm	5

pentru cercevea cu FFB > 1400 mm si greutatea > 100 Kg.





Accesorii



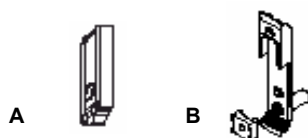

	Argintiu N 	Prelungitor			
A	10585	250 mm	400 - 1650	370 - 2350	50
B	10586	250 mm cu rola de inchidere	280 - 650	370 - 2350	50
C	55876	600/400 mm cu rola de inchidere	400 - 1400	370 - 2350	50







	Argintiu N 	Schnapper	
A	52502	pt. ferestre si usi-balcon	50
B	10944	pt. ferestre si usi-balcon - luft 4 mm	20
	44349	distantier 3 mm pt. schnapper	100



	Argintiu N 	Blocator	
A	12065	galben cu zavor	20
	10534	argintiu cu zavor	20
	12067	alb cu zavor	20
B	12068	maro cu zavor	20
	12066	galben cu cheie	20
	10535	argintiu cu cheie	20
	12069	alb cu cheie	20
	12070	maro cu cheie	20





	Argintiu N 	Foarfece a-2-a		
A	10596	A doua foarfeca 350 mm - pt ferestre >100 kg.	1400 -1650	20



Informatii tehnice

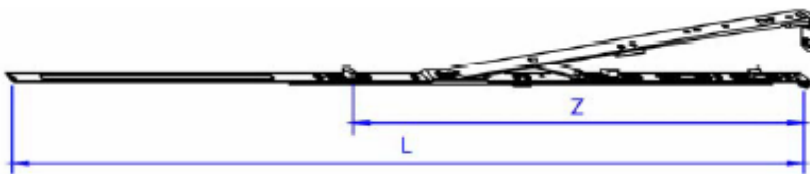

Foarfece DT



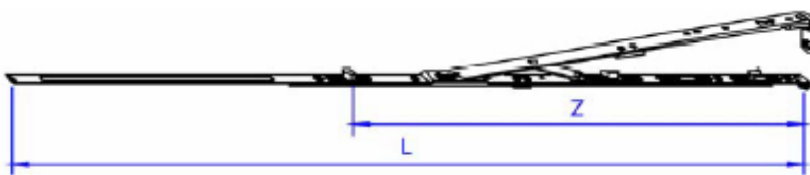

	
Gr.00	3
Gr.0	3
Gr.1	4
	
Gr.2	5
Gr.3	6
Gr.4	7

Foarfece DT cu deschidere in doua trepte



	
Gr.0	3
Gr.1	4
	
Gr.2	5
Gr.3	6



							
Gr.00	20	145	158				
Gr.0	20	154	167				
Gr.1	20	100	237	371,5			
Gr.2	20	100	323	452	564		
Gr.3	20	100	307	433,5	673	803	
Gr.4	20	100	307	433,5	657	873	1053

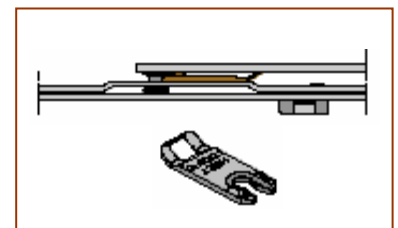

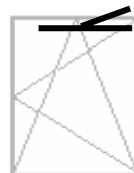

H	Argintiu N ^o	Foarfece DT	L	Z			
A	52443	Gr. 00	255	-	400 - 430	280 - 310	10
	52444	Gr. 0	475	-	431 - 630	311 - 500	10
	52445	Gr. 1	670	-	601 - 800	501 - 700	10
B	52446	Gr. 2	920	528	801 - 1050	-	10
	52447	Gr. 3	1160	628	1051 - 1300	-	10
	52448	Gr. 4	1410	828	1301 - 1400	-	10

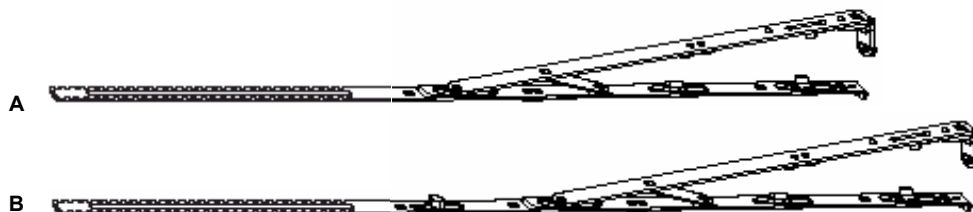

H	Argintiu N ^o	Foarfece DT cu deschidere in doua trepte	L	Z			
A	52660	dreapta Gr. 0	475	-	431 - 630	311 - 500	10
	52661	stanga Gr. 0	475	-	431 - 630	311 - 500	10
	52662	dreapta Gr. 1	670	-	601 - 800	501 - 700	10
B	52663	stanga Gr. 1	670	-	601 - 800	501 - 700	10
	52664	dreapta Gr. 2	920	528	801 - 1050	-	10
	52665	stanga Gr. 2	920	528	801 - 1050	-	10
	52666	dreapta Gr. 3	1160	628	1051 - 1300	-	10
	52667	stanga Gr. 3	1160	628	1051 - 1300	-	10





H	N ^o	Distantier	
A	43551	pt. foarfeca Gr.00 - 1 negru	100
	43552	pt. foarfeca Gr.2 - 4 alb	100



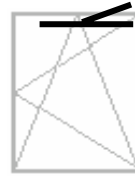
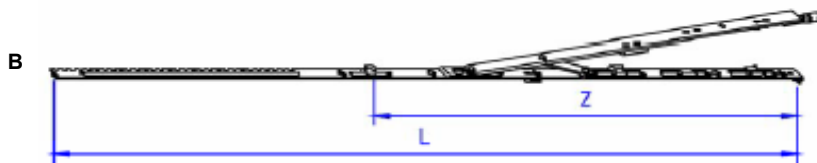

H	N ^o	Siguranta suplimentara	
A	43548	pt. foarfeca Gr.00 - 1 negru	50
	43549	pt. foarfeca Gr.2 - 4 alb	50

**Informatii tehnice****Foarfece TO**

	
Gr.00	3
Gr.0	3
Gr.1	4

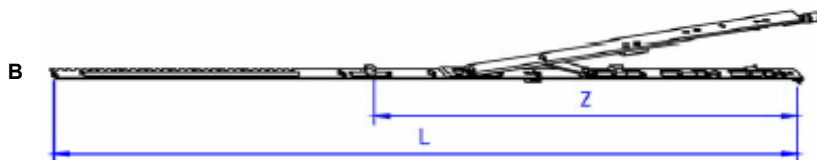



	
Gr.2	5
Gr.3	6
Gr.4	7

Foarfece TO cu deschidere in doua trepte

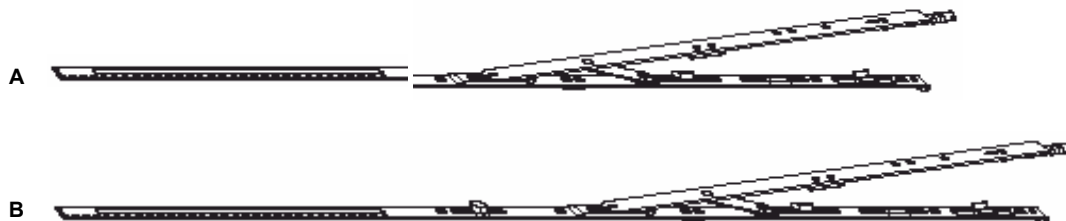
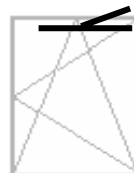



	
Gr.0	3
Gr.1	4

	
Gr.2	5
Gr.3	6

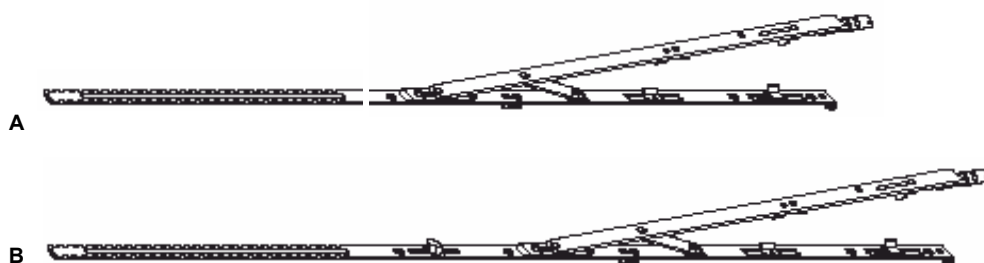

	Argintiu N ^o	Foarfece TO	L	Z			
A	55150	Gr. 00	255	-	400 - 430	280 - 310	10
	55155	Gr. 0	475	-	431 - 630	311 - 500	10
	55156	Gr. 1	670	-	601 - 800	501 - 700	10
B	55157	Gr. 2	920	528	801 - 1050	-	10
	55289	Gr. 3	1160	628	1051 - 1300	-	10
	55151	Gr. 4	1410	828	1301 - 1400	-	10



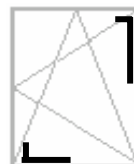

	Argintiu N ^o	Foarfece TO cu deschidere in doua trepte	L	Z			
A	52668	dreapta Gr. 0	475	-	431 - 630	311 - 500	10
	52669	stanga Gr. 0	475	-	431 - 630	311 - 500	10
	52670	dreapta Gr. 1	670	-	601 - 800	501 - 700	10
B	52671	stanga Gr. 1	670	-	601 - 800	501 - 700	10
	52672	dreapta Gr. 2	920	528	801 - 1050	-	10
	52673	stanga Gr. 2	920	528	801 - 1050	-	10
	52674	dreapta Gr. 3	1160	628	1051 - 1300	-	10
	52675	stanga Gr. 3	1160	628	1051 - 1300	-	10



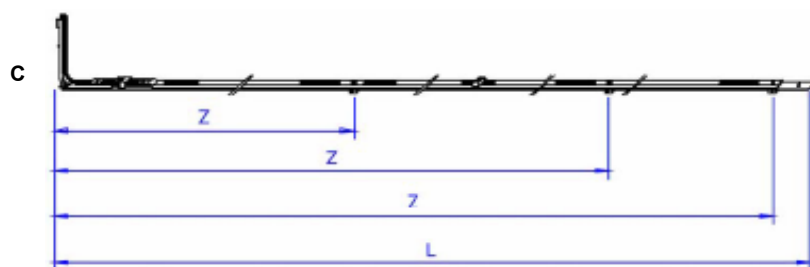
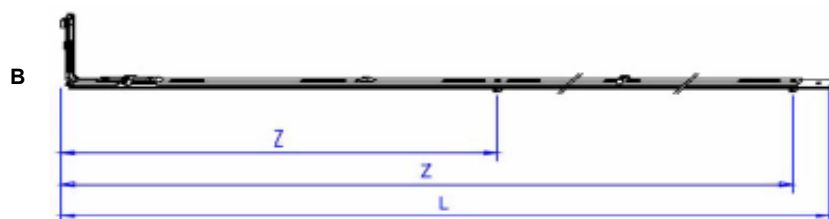
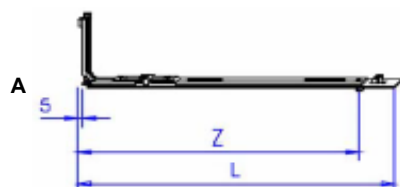

Informatii tehnice

Tija inchidere suplimentara





	
MV 300	3
Gr.00	4
Gr.0	5
Gr.1	5
Gr.2	6

	
Gr.3	8

	
Gr.4	11

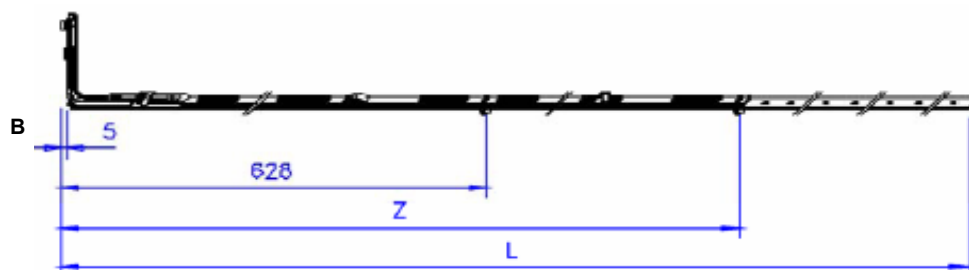
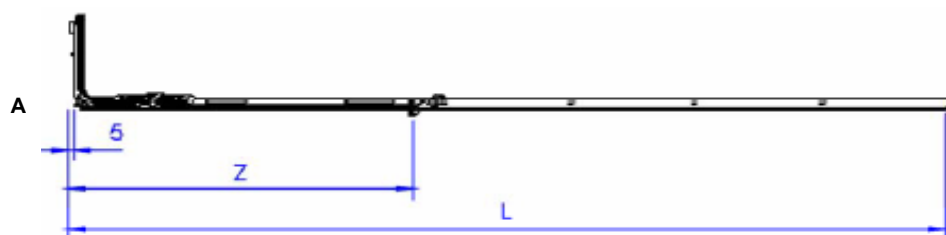
Tija inchidere suplimentara cu sina lunga



A	
400	6
528	8
628	9
685	10
828	13

	
B	
628/1178	13

MACO MULTI TREND

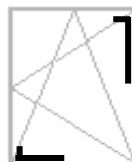

H	Argintiu N \equiv	Tija inchidere suplimentara	L	Z			
A	52453	MV 300	357	300	600 - 750	600 - 750	20
	54674	Gr. 00	457	400	751 - 1050	751 - 1050	20
	54675	Gr. 0	585	528	1051 - 1300	1051 - 1300	20
	54676	Gr. 1	685	628	1251 - 1500	1251 - 1500	20
	52457	Gr. 2	885	828	1501 - 1650	1501 - 1750	20
B	57276	Gr. 3	1235	628/1178	-	1751 - 2350	20
C	59920	Gr. 4	1735	628/1178/1678		1951 - 2350	20



H	Argintiu N \equiv	Tija inchidere suplimentara cu sina lunga	L	Z			
A	55194	400 cu sina lunga	1045	400	751 - 1050	751 - 1050	10
	55195	528 cu sina lunga	1295	528	1051 - 1300	1051 - 1300	10
	55060	628 cu sina lunga	1495	628	1251 - 1500	1251 - 1500	10
B	55061	828 cu sina lunga	1745	828	1501 - 1650	1501 - 1750	10
	55196	1178 cu sina lunga	2295	628/1178	-	1751 - 2350	10





Silber Nr.																
52453	89	177	347													
54674	89	177	355	447												
54675	89	177	330	483	575											
54676	89	177	380	583	675											
52457	89	177	380	581	783	875										
52458	89	177	380	583	670	901	1133	1225								
59920	89	177	380	583	670	901	1133	1220	1451	1633	1725					
52823	89	177	380	583	670	901	1133	1215								
55194	89	177	355	447	590	740	895									
55195	89	177	330	483	575	695	845	995	1145							
55060	89	177	380	583	675	790	935	1080	1225	1370						
55061	89	177	380	581	783	875	1000	1155	1310	1465	1620					
55196	89	177	380	583	670	901	1133	1225	1370	1625	1680	1835	1990	2145		



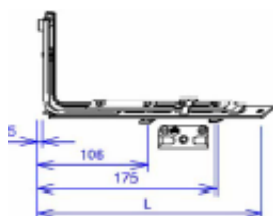

Informatii tehnice

Tija inchidere orizontal-basculanta

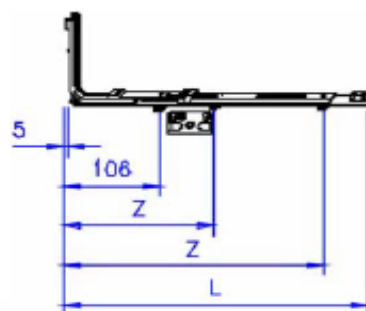

A	
227	2



B	
357	3
457	4
585	5
685	5
885	6

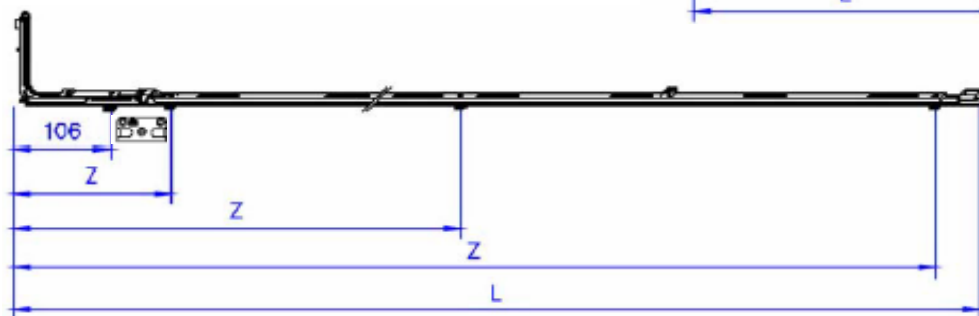

C	
1085	8
1235	9

Important !

Asigura inchiderea pentru miscarea de oscilatie (basculare) in plan orizontal si inchiderea de siguranta "Nivel de Baza"

Pentru a realiza miscarea de oscilatie (basculare) in plan orizontal si inchiderea de siguranta "Nivel de Baza" se va intrebuinta si piesa de inchidere antiefractie



Dimensiuni									
175	139,5	219							
300	139,5	219	347						
400	139,5	219	355	447					
528	139,5	219	345	483	575				
628	139,5	219	380	583	675				
828	139,5	219	380	581	783	875			
1028	139,5	219	345	483	570	775	983	1075	
1178	139,5	219	380	583	670	901	1133	1225	

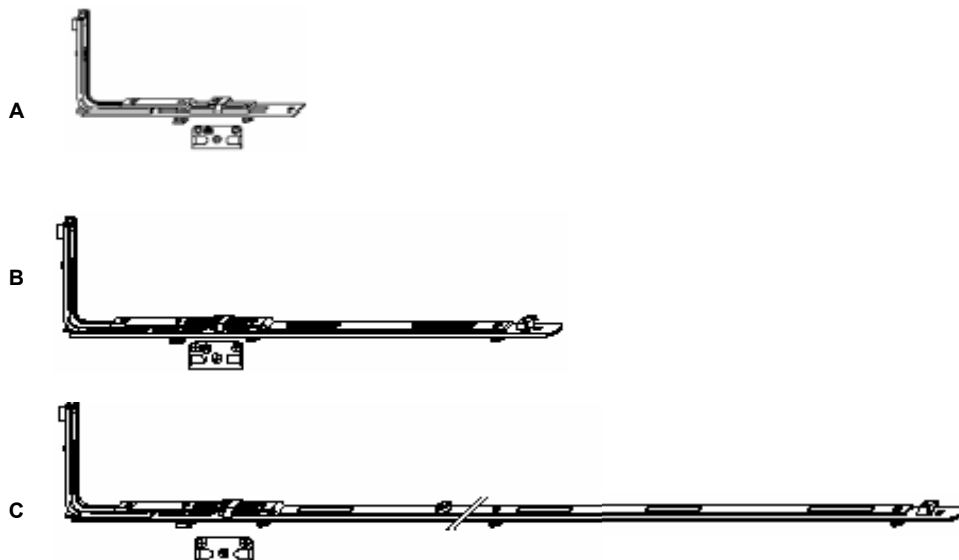

H	Argintiu N	Tija inchidere orizontal-basculanta	L	Inchidere		
				suplimentara	antiefractione	
A	59929	Z = 175 mm 1 i.S. pt. tj.cr. Gr.00	227	280 - 600	279 - 480	20
	52812	Z = 175 mm 1 i.S.	227	280 - 600	280 - 480	20
B	57207	Z = 175 / 300 mm 1 i.S.	357	601 - 750	481 - 570	20
	52767	Z = 175 / 400 mm 2 i.S	457	751 - 1050	571 - 800	20
	52768	Z = 175 / 528 mm 2 i.S	585	1051 - 1300	-	20
	52769	Z = 175 / 628 mm 2 i.S	685	1251 - 1500	801 - 1000	20
	52770	Z = 175 / 828 mm 2 i.S	885	1501 - 1750	1001 - 1300	20
C	55879	Z = 175 / 528 / 1028 mm 3 i.S.	1085	-	1201 - 1300	20
	52771	Z = 175 / 628 / 1178 mm 3 i.S	1235	-	1301 - 1500	20

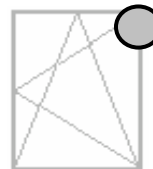

Informatii tehnice

Balama toc sus DT

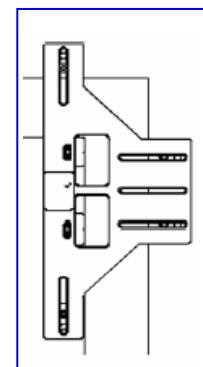
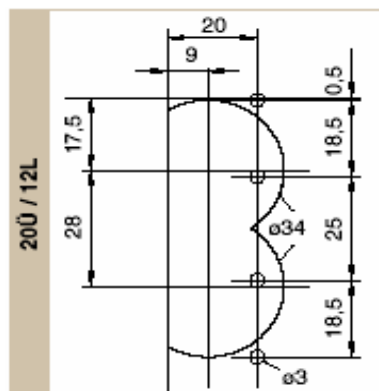
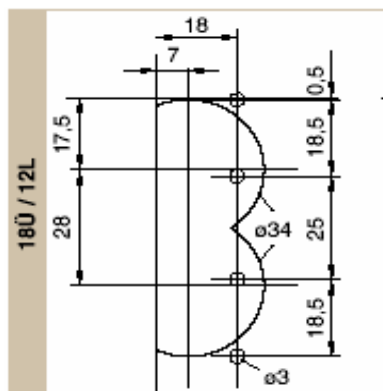
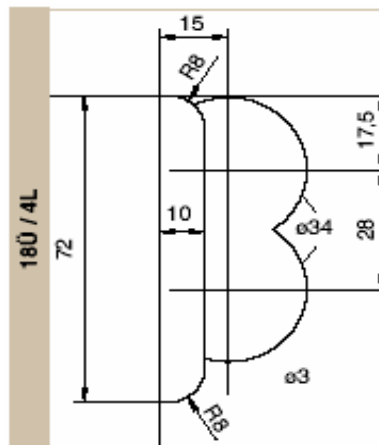
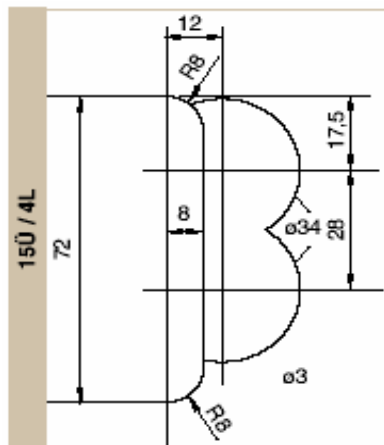
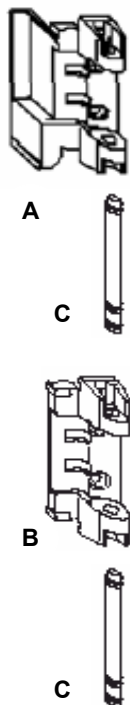

sablon	sistem	Fr.	l.ex.
20890	12L	ø 34	ø 40
52223	4L	ø 16	ø 27

- °° Freza cu diametru 34
- °° Inelul de centrare pe sablon, cu diametrul exterior 40 si diametrul interior de ~ 36

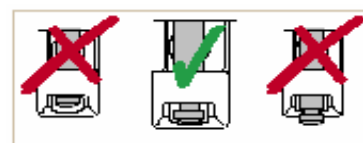
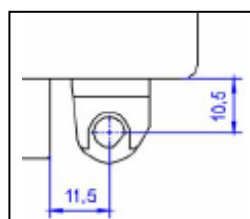
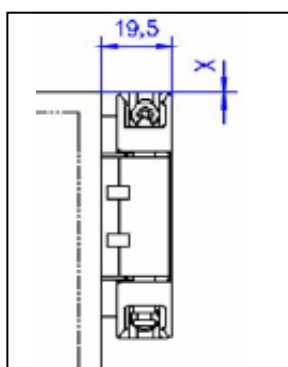

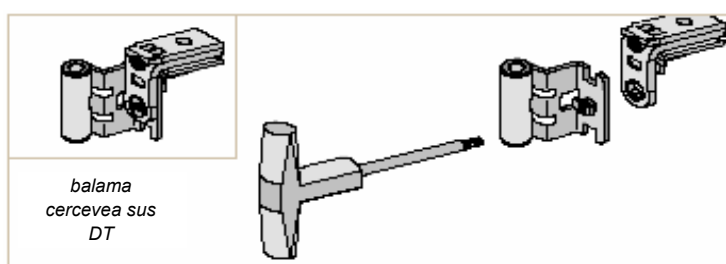

18Ü/12L – x=0
20Ü/12L – x=-2

Balama cercevea sus DT

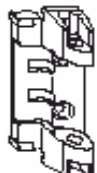
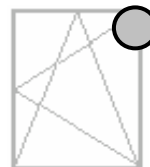





	N ^o	Balama sus DT 130 kg.	Culoare	Parametrii	
A	202545	Balama toc sus DT stanga/dreapta - 4 Luft / 15Ü	argintiu	15Ü/4L	50
	202541	Balama toc sus DT dreapta - 4 Luft / 18Ü	argintiu	18Ü/4L	50
	202542	Balama toc sus DT stanga - 4 Luft / 18Ü	argintiu	18Ü/4L	50
B	202543	Balama toc sus DT stanga/dreapta 12 Luft / 18Ü	argintiu	18Ü/12L	50
	202544	Balama toc sus DT stanga/dreapta 12 Luft / 20Ü	argintiu	20Ü/12L	50
	203675	Balama toc sus DT dreapta - 4 Luft / 18Ü	alb	18Ü/4L	50
	203676	Balama toc sus DT stanga - 4 Luft / 18Ü	alb	18Ü/4L	50
	203677	Balama toc sus DT stanga/dreapta 12 Luft / 18Ü	alb	18Ü/12L	50
	203678	Balama toc sus DT stanga/dreapta 12 Luft / 20Ü	alb	20Ü/12L	50
	C	94491	Stift pt balama toc sus DT	argintiu	
D	202533	Balama cercevea sus DT stanga/dreapta - 4 Luft / 15Ü	argintiu	15Ü axa 9 mm	50
	202534	Balama cercevea sus DT stanga/dreapta -12 Luft / 18Ü	argintiu	18Ü axa 9 mm	50
	202539	Balama cercevea sus DT stanga/dreapta -12 Luft / 18Ü	argintiu	18Ü axa 11 mm	50
	202535	Balama cercevea sus DT stanga/dreapta -12 Luft / 18Ü	argintiu	18Ü axa 13 mm	50
	202536	Balama cercevea sus DT stanga/dreapta -12 Luft / 20Ü	argintiu	20Ü axa 9 mm	50
	202537	Balama cercevea sus DT stanga/dreapta -12 Luft / 20Ü	argintiu	20Ü axa 13 mm	50
	203679	Balama cercevea sus DT stanga/dreapta - 4 Luft / 15Ü	alb	15Ü axa 9 mm	50
	203680	Balama cercevea sus DT stanga/dreapta -12 Luft / 18Ü	alb	18Ü axa 9 mm	50
	203681	Balama cercevea sus DT stanga/dreapta -12 Luft / 18Ü	alb	18Ü axa 13 mm	50
	203682	Balama cercevea sus DT stanga/dreapta -12 Luft / 20Ü	alb	20Ü axa 9 mm	50

A



B



	N ^o	Capac pentru balama sus DT			
A	42083	alb	capac balama toc sus DT	100	
	42097	bronz	capac balama toc sus DT	100	
	42098	alama	capac balama toc sus DT	100	
	42099	titan	capac balama toc sus DT	100	
	42103	sampanie	capac balama toc sus DT	100	
	43761	argintiu	capac balama toc sus DT	100	
	42191	crem	capac balama toc sus DT	100	
	42189	maro	capac balama toc sus DT	100	
	44243	crom	capac balama toc sus DT	100	
	B	42084	alb	capac balama cercevea sus DT	100
		42105	bronz	capac balama cercevea sus DT	100
42106		alama	capac balama cercevea sus DT	100	
42107		titan	capac balama cercevea sus DT	100	
42108		sampanie	capac balama cercevea sus DT	100	
43760		argintiu	capac balama cercevea sus DT	100	
42194		crem	capac balama cercevea sus DT	100	
42192		maro	capac balama cercevea sus DT	100	
44244		crom	capac balama cercevea sus DT	100	

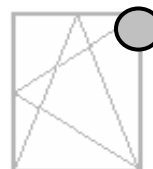

Informatii tehnice

Balama toc sus TO

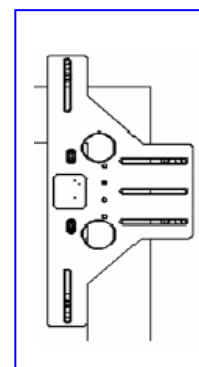
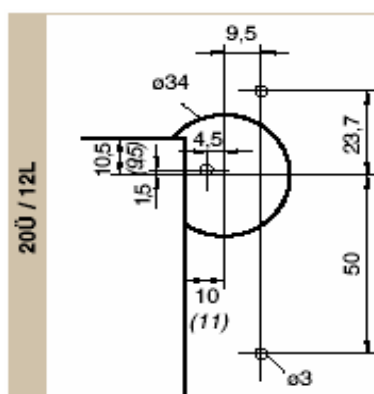
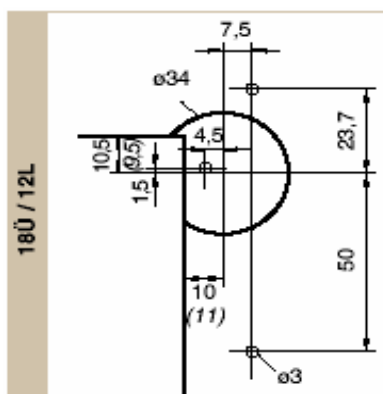
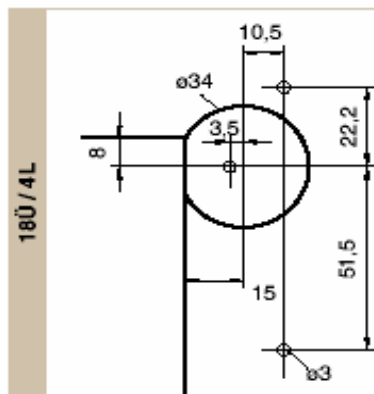
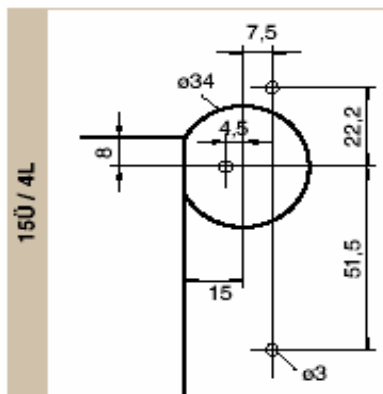

sablon	sistem	Fr.	l.ex.
22016	15Ü / 4L	ø 16	ø 27
21723	15Ü / 4L	ø 34	ø 40
21724	18Ü / 4L	ø 34	ø 40
21725	18Ü / 12L	ø 34	ø 40
21726	20Ü / 12L	ø 34	ø 40

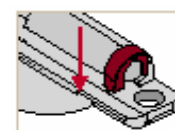
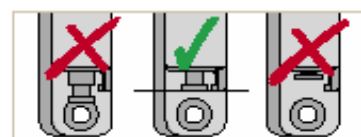
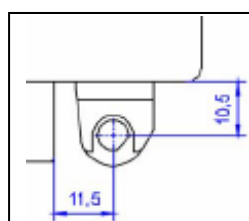
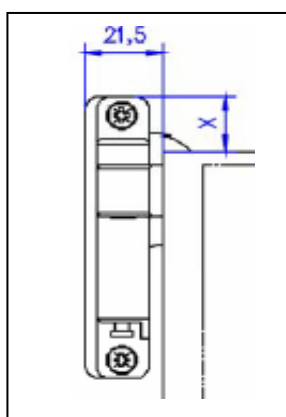

- 15Ü/ 4L x=16 mm
- 18Ü/ 4L x=13 mm
- 18Ü/ 12L x=13 mm
- 20Ü/ 12L x=11 mm

Balama cercevea sus TO

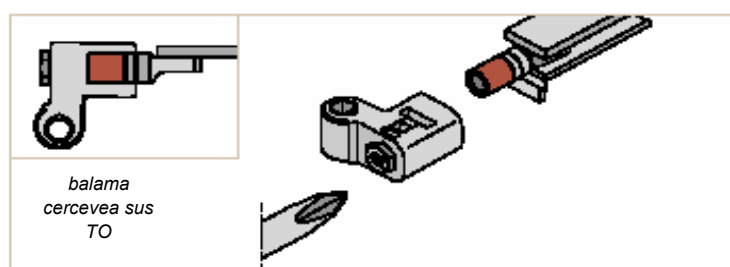
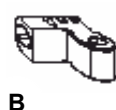

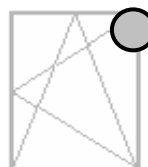

balama cercevea sus TO



A



B

	N ^o	Balama sus TO 130 kg.	Culoare	Parametrii	
A	55414	Balama toc sus TO dreapta - 4 Luft / 15Ü - axa 9 mm	argintiu	15Ü/4L	50
	55415	Balama toc sus TO stanga - 4 Luft / 15Ü - axa 9mm	argintiu	15Ü/4L	50
	55235	Balama toc sus TO dreapta - 4 Luft / 18Ü - axa 9 mm	argintiu	18Ü/4L	50
	55236	Balama toc sus TO stanga - 4 Luft / 18Ü - axa 9 mm	argintiu	18Ü/4L	50
	52396	Balama toc sus TO dreapta - 12 Luft / 18Ü - axa 9 mm	argintiu	18Ü/12L	50
	52397	Balama toc sus TO stanga - 12 Luft / 18Ü - axa 9 mm	argintiu	18Ü/12L	50
	54716	Balama toc sus TO dreapta - 12 Luft / 20Ü - axa 9 mm	argintiu	20Ü/12L	50
	54717	Balama toc sus TO stanga - 12 Luft / 20Ü - axa 9 mm	argintiu	20Ü/12L	50
	53927	Balama toc sus TO dreapta - 4 Luft / 15Ü - axa 9 mm	alb	15Ü/4L	50
	53928	Balama toc sus TO stanga - 4 Luft / 15Ü - axa 9 mm	alb	15Ü/4L	50
	22519	Balama toc sus TO dreapta - 12 Luft / 18Ü - axa 9 mm	alb	18Ü/12L	50
	22517	Balama toc sus TO stanga - 12 Luft / 18Ü - axa 9 mm	alb	18Ü/12L	50
B	55416	Balama cercevea sus TO	argintiu	15Ü	50
	52388	Balama cercevea sus TO	argintiu	18Ü	50
	54718	Balama cercevea sus TO	argintiu	20Ü	50
	52508	Balama cercevea sus TO	alb	15Ü	50
	22526	Balama cercevea sus TO	alb	18Ü	50



A

B

	N ^o		Capac pentru balama toc sus TO		
	Dreapta	Stanga	Culoare		
A	40498	40499	alb	capac balama toc sus TO	50
	41574	41576	bronz	capac balama toc sus TO	50
	40503	40505	alama	capac balama toc sus TO	50
	40761	40763	tirtan	capac balama toc sus TO	50
	41696	41695	sampanie	capac balama toc sus TO	50
	40746	40747	maro	capac balama toc sus TO	50
	B	Dreapta / Stanga			
40506			alb	capac balama cercevea sus TO	50
41587			bronz	capac balama cercevea sus TO	50
40508			alama	capac balama cercevea sus TO	50
40760			titan	capac balama cercevea sus TO	50
41697			sampanie	capac balama cercevea sus TO	50
40745			maro	capac balama cercevea sus TO	50

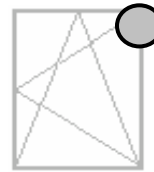

Informatii tehnice

Balama toc sus TO scurta



A

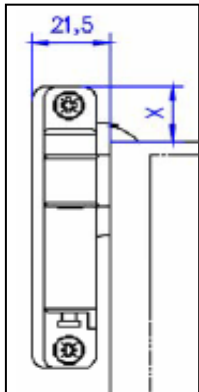

15Ü/ 4L x=7 mm
 18Ü/ 4L x=4mm
 18Ü/ 12L x=4 mm
 20Ü/ 12L x=2 mm

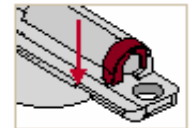
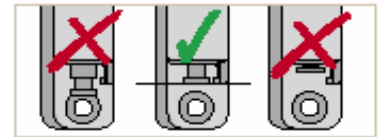
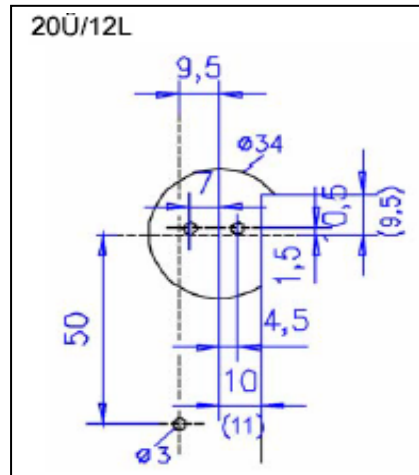
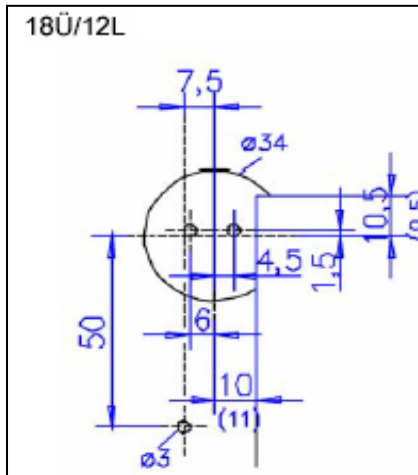
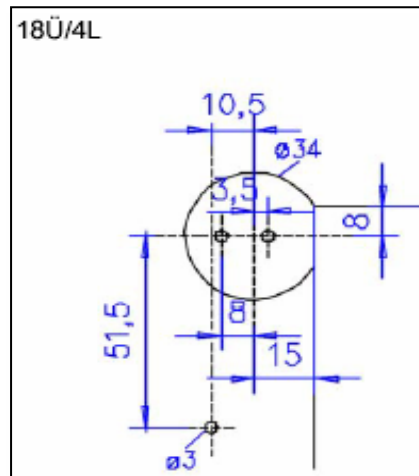
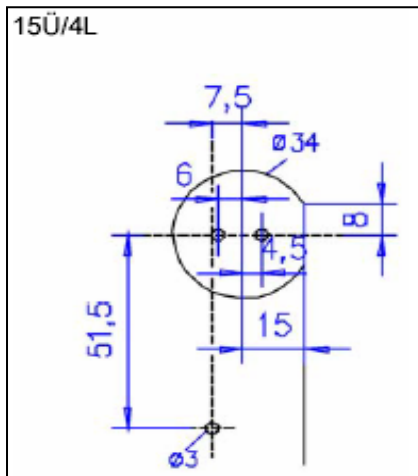
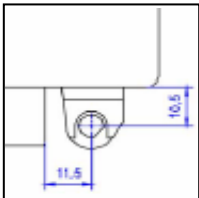

sablon	sistem	Fr.	I.ex.
22016	15Ü / 4L	ø 16	ø 27
21723	15Ü / 4L	ø 34	ø 40
21724	18Ü / 4L	ø 34	ø 40
21725	18Ü / 12L	ø 34	ø 40
21726	20Ü / 12L	ø 34	ø 40

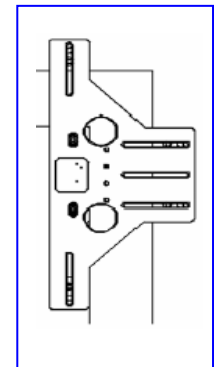

Balama toc sus TO cu o singura frezare



A

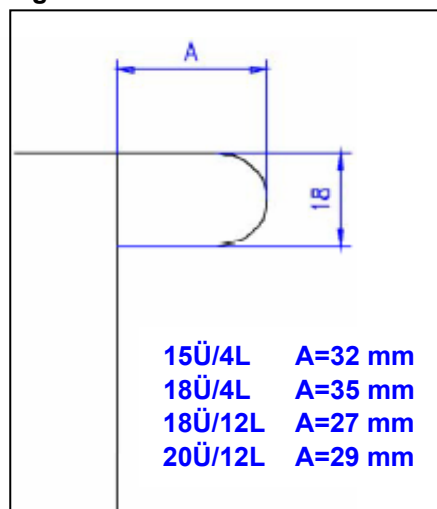

15Ü/4L A=32 mm
 18Ü/4L A=35 mm
 18Ü/12L A=27 mm
 20Ü/12L A=29 mm

L = 4mm => 4L
 sau
 L = 12mm => 12L

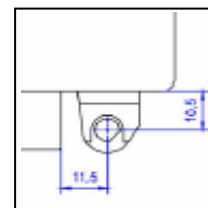
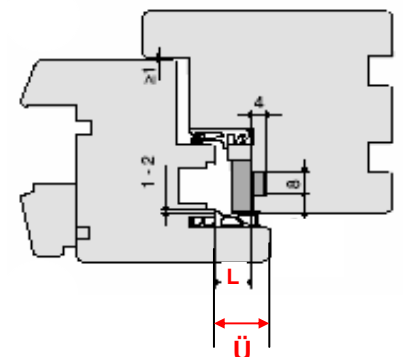

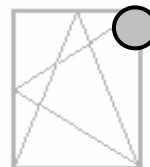

15Ü/ 4L x=15 mm
 18Ü/ 4L x=12 mm
 18Ü/ 12L x=13 mm
 20Ü/ 12L x=11 mm

°°Sablon Nr. 28336
 °°Inel de centrare pe
 sablon cu diametru
 exterior 27





A

	N ID	Balama sus TO scurta 80 kg.	Culoare	Parametrii	
A	52642	Balama toc sus TO dreapta - 12 Luft / 18Ü - axa 9 mm	argintiu	18Ü/12L	50
	52643	Balama toc sus TO stanga - 12 Luft / 18Ü - axa 9mm	argintiu	18Ü/12L	50



A

	N ID	Balama sus TO cu o singura frezare	Culoare		
A	58076	Balama toc sus TO dreapta	argintiu		50
	58077	Balama toc sus TO stanga	argintiu		50

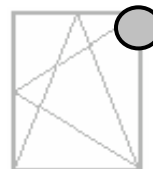

Informatii tehnice

Balama toc jos DT

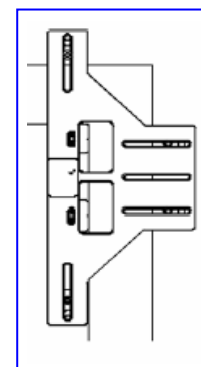
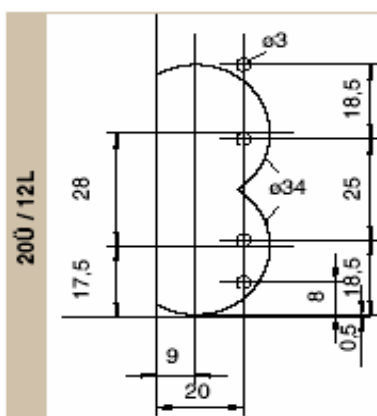
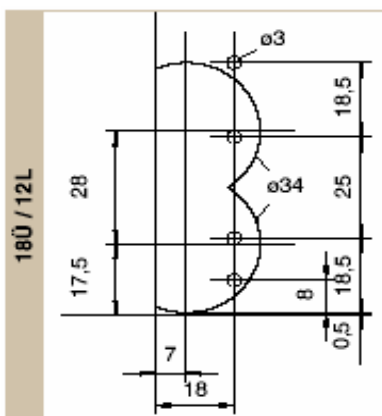
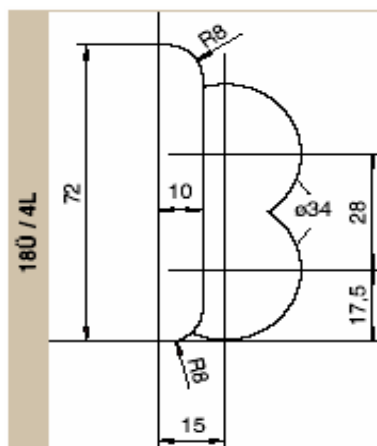
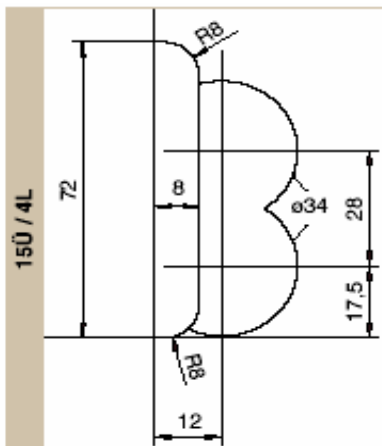
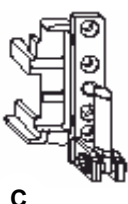
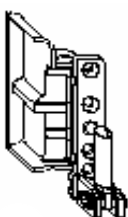
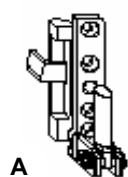

sablon	sistem	Fr.	I.ex.
20890	12L	ø 34	ø 40
52223	4L	ø 16	ø 27

°° Freza cu diametru 34
 °° Inelul de centrare pe sablon, cu diametrul exterior 40 si diametrul interior de ~ 36

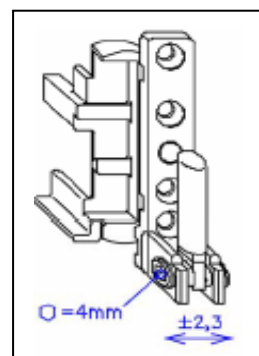
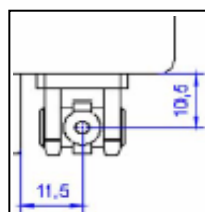
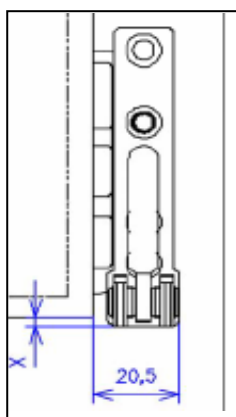

180/12L x = 2 mm
 200/12L x = 0 mm

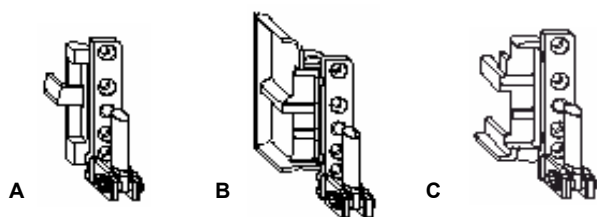
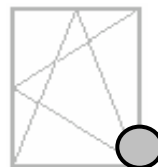

	N	Balama toc jos DT 130 kg.		Culoare	Parametrii	
A	55492	dreapta	Balama toc jos DT	argintiu	15Ü/4L	50
	55493	stanga	Balama toc jos DT	argintiu	15Ü/4L	50
	55436	dreapta	Balama cercevea jos DT	alb	15Ü/4L	50
B	55437	stanga	Balama cercevea jos DT	alb	15Ü/4L	50
	55092	dreapta	Balama toc jos DT	argintiu	18Ü/4L	50
	55093	stanga	Balama toc jos DT	argintiu	18Ü/4L	50
C	50994	dreapta	Balama cercevea jos DT	alb	18Ü/4L	50
	50995	stanga	Balama cercevea jos DT	alb	18Ü/4L	50
	52703	dreapta	Balama toc jos DT	argintiu	18Ü/12L	50
	52704	stanga	Balama toc jos DT	argintiu	18Ü/12L	50
	54726	dreapta	Balama cercevea jos DT	argintiu	20Ü/12L	50
	54727	stanga	Balama cercevea jos DT	argintiu	20Ü/12L	50
	52237	dreapta	Balama cercevea jos DT	alb	18Ü/12L	50
	52238	stanga	Balama cercevea jos DT	alb	18Ü/12L	50
	52239	dreapta	Balama cercevea jos DT	alb	20Ü/12L	50
	52240	stanga	Balama cercevea jos DT	alb	20Ü/12L	50



	N	Capac pentru balama toc jos DT		
A	41742	alb	capac scurt	100
	41762	bronz	capac scurt	100
	41763	alama	capac scurt	100
	42048	titan	capac scurt	100
	42049	sampanie	capac scurt	100
	43566	argintiu	capac scurt	100
	42195	maro	capac scurt	100
	42241	crom	capac scurt	100
B	41743	alb	capac lung	100
	41752	bronz	capac lung	100
	41760	alama	capac lung	100
	42057	titan	capac lung	100
	42058	sampanie	capac lung	100
	43567	argintiu	capac lung	100
	42208	maro	capac lung	100
	44242	crom	capac lung	100

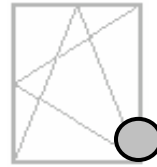



Informatii tehnice

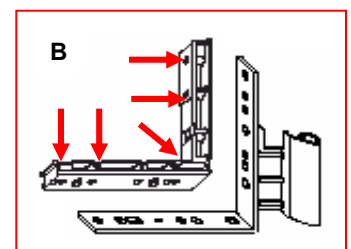
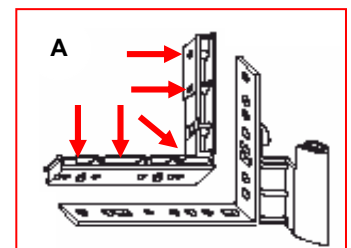
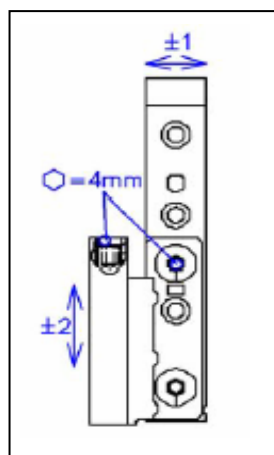
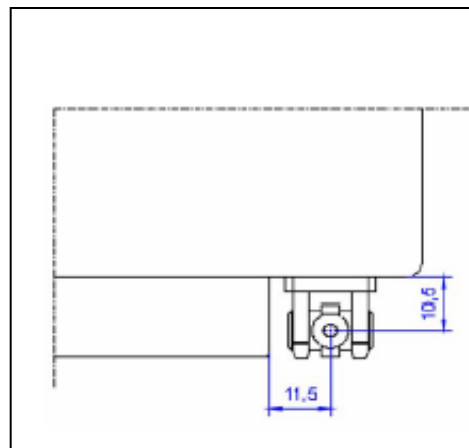
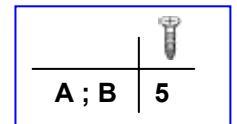
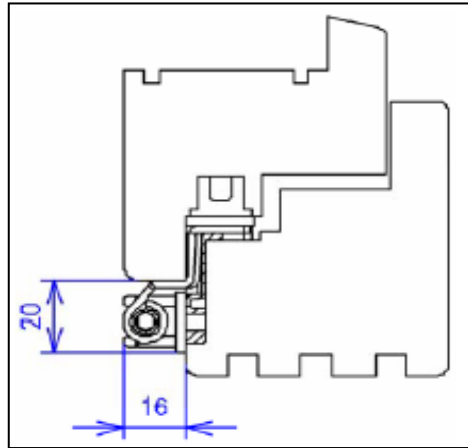
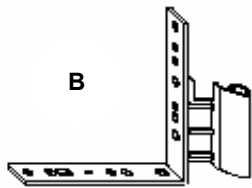
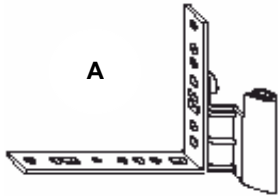

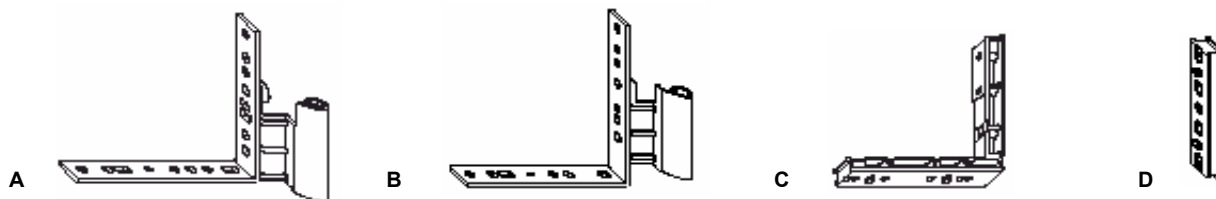
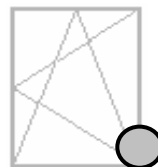
Balama cercevea jos DT



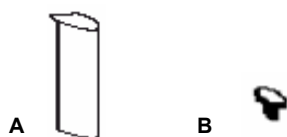

	N ^o	Balama cercevea jos DT 100 kg.		UZ	Culoare	Parametrii	
A	55097	dreapta	Balama toc jos DT - axa 9 mm	fereastră	argintiu	18Ü/4L	50
	55098	stanga	Balama toc jos DT - axa 9 mm	fereastră	argintiu	18Ü/4L	50
	52706	dreapta	Balama cercevea jos DT - axa 9 mm	fereastră	argintiu	18Ü/12L	50
	52707	stanga	Balama cercevea jos DT - axa 9 mm	fereastră	argintiu	18Ü/12L	50
	54728	dreapta	Balama toc jos DT - axa 9 mm	fereastră	argintiu	20Ü/12L	50
	54729	stanga	Balama toc jos DT - axa 9 mm	fereastră	argintiu	20Ü/12L	50
	50996	dreapta	Balama toc jos DT - axa 9 mm	fereastră	alb	18Ü/4L	50
	50997	stanga	Balama toc jos DT - axa 9 mm	fereastră	alb	18Ü/4L	50
	52241	dreapta	Balama cercevea jos DT - axa 9 mm	fereastră	alb	18Ü/12L	50
	52242	stanga	Balama cercevea jos DT - axa 9 mm	fereastră	alb	18Ü/12L	50
	52243	dreapta	Balama toc jos DT - axa 9 mm	fereastră	alb	20Ü/12L	50
	52244	stanga	Balama toc jos DT - axa 9 mm	fereastră	alb	20Ü/12L	50
B	57232	dreapta	Balama toc jos DT - axa 9 mm	prag AL	argintiu	18Ü/12L	50
	57233	stanga	Balama toc jos DT - axa 9 mm	prag AL	argintiu	18Ü/12L	50
C	41262	Suport adaptor pentru balama cercevea jos DT					100
D	40485	Suport adaptor pentru balama cercevea jos DT					100
	40486	Suport adaptor pentru balama cercevea jos DT - pt distanta de 1 mm					100



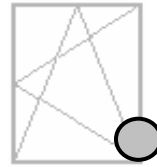

	N ^o		Capac pentru balama cercevea jos DT		
	Dreapta	Stanga			
A	41740	41741	alb	capac balama cercevea jos DT	100
	41764	41770	bronz	capac balama cercevea jos DT	100
	41769	41771	alama	capac balama cercevea jos DT	100
	42063	42060	titan	capac balama cercevea jos DT	100
	42064	42061	sampanie	capac balama cercevea jos DT	100
	43564	43565	argintiu	capac balama cercevea jos DT	100
	42599	42598	maro	capac balama cercevea jos DT	100
	44239	44240	crom	capac balama cercevea jos DT	100
B	42085		auriu	capac contra mizeriei	100
	43701		argintiu	capac contra mizeriei	100
	42185		alb	capac contra mizeriei	100



Informatii tehnice

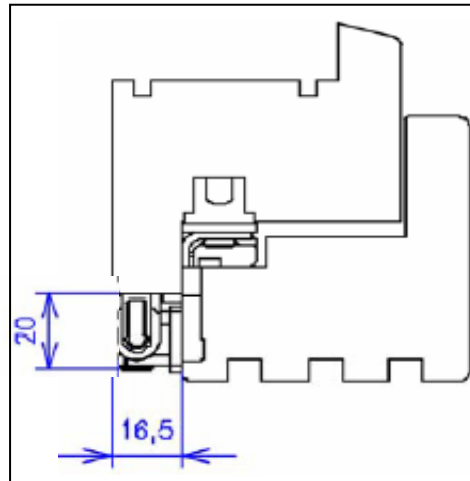
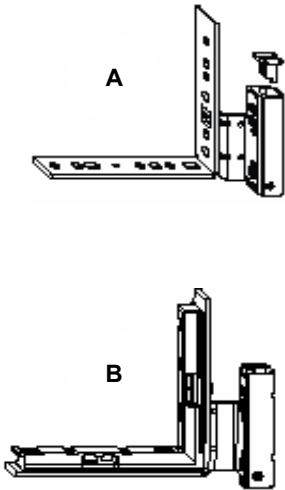

Balama cercevea jos DT

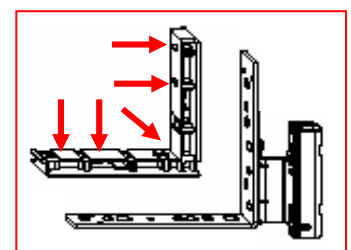
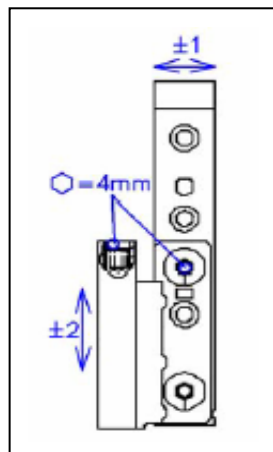
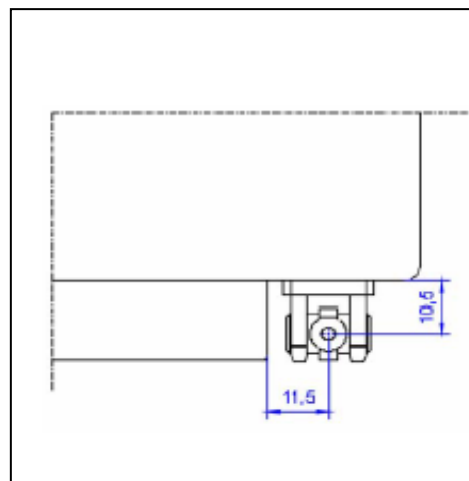

A ; B ; C	
	5

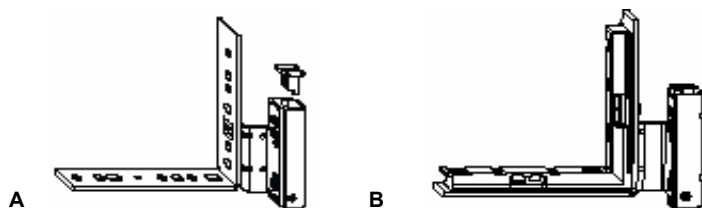
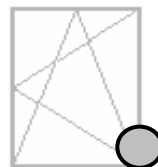



	N ^o	Balama cercevea jos DT cu fixare pe inaltimea etansarii (Ü) 130 kg.	UZ	Culoare	Parametrii	
A	55494	dreapta-Balama toc jos DT axa 9 mm	fereastră	argintiu	15Ü/4L	50
	55494	stanga- Balama toc jos DT axa 9 mm	fereastră	argintiu	15Ü/4L	50
	220048	dreapta-Balama toc jos DT axa 9 mm	fereastră	argintiu	18Ü/4L	50
	220051	stanga- Balama toc jos DT axa 9 mm	fereastră	argintiu	18Ü/4L	50
	54710	dreapta-Balama toc jos DT axa 9 mm	fereastră	argintiu	18Ü/12L	50
	54711	stanga- Balama toc jos DT axa 9 mm	fereastră	argintiu	18Ü/12L	50
	54764	dreapta-Balama toc jos DT axa 9 mm	fereastră	alb	18Ü/12L	50
	54765	stanga- Balama toc jos DT axa 9 mm	fereastră	alb	18Ü/12L	50
	55450	dreapta-Balama toc jos DT axa 13 mm	fereastră	alb	18Ü/12L	50
	55451	stanga- Balama toc jos DT axa 13 mm	fereastră	alb	18Ü/12L	50
B	54766	dreapta-Balama toc jos DT axa 9 mm	fereastră	alb	20Ü/12L	50
	54767	stanga- Balama toc jos DT axa 9 mm	fereastră	alb	20Ü/12L	50
	57116	dreapta-Balama toc jos DT cu suport axa 9 mm	fereastră	argintiu	18Ü/12L	50
	58117	stanga- Balama toc jos DT cu suport axa 9 mm	fereastră	argintiu	18Ü/12L	50
	201016	dreapta-Balama toc jos DT axa 11 mm	fereastră	argintiu	18Ü/12L	50
	201017	stanga- Balama toc jos DT axa 11 mm	fereastră	argintiu	18Ü/12L	50
	55452	dreapta-Balama toc jos DT axa 13 mm	fereastră	argintiu	18Ü/12L	50
	55453	stanga- Balama toc jos DT axa 13 mm	fereastră	argintiu	18Ü/12L	50
	54712	dreapta-Balama toc jos DT axa 9 mm	fereastră	argintiu	20Ü/12L	50
	54713	stanga- Balama toc jos DT axa 9 mm	fereastră	argintiu	20Ü/12L	50
	220045	dreapta-Balama toc jos DT axa 13 mm	fereastră	argintiu	20Ü/12L	50
	220046	stanga- Balama toc jos DT axa 13 mm	fereastră	argintiu	20Ü/12L	50
	55438	dreapta-Balama toc jos DT axa 9 mm	fereastră	argintiu	15Ü/4L	50
	55439	stanga- Balama toc jos DT axa 9 mm	fereastră	argintiu	15Ü/4L	50
	220049	dreapta-Balama toc jos DT axa 9 mm	fereastră	argintiu	18Ü/4L	50
220052	stanga- Balama toc jos DT axa 9 mm	fereastră	argintiu	18Ü/4L	50	

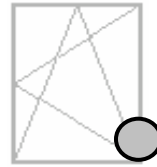

Informatii tehnice

Balama cercevea jos DT

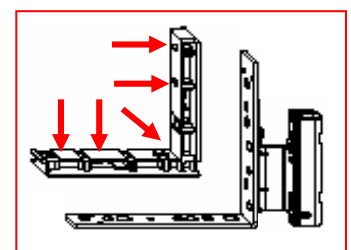
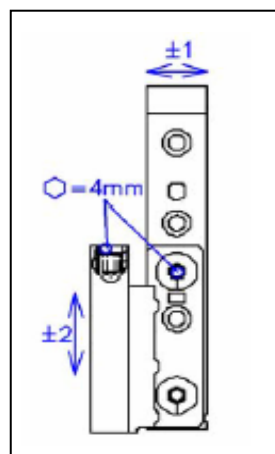
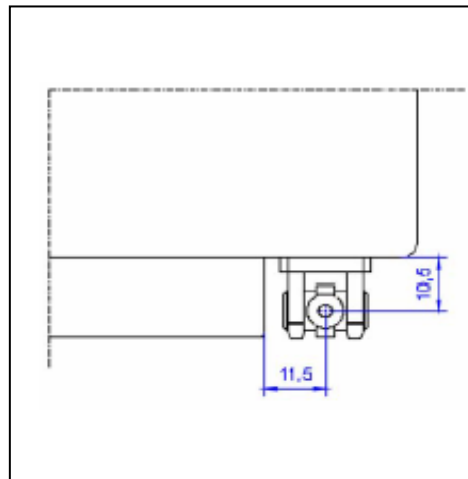
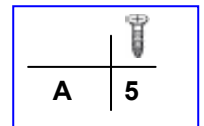
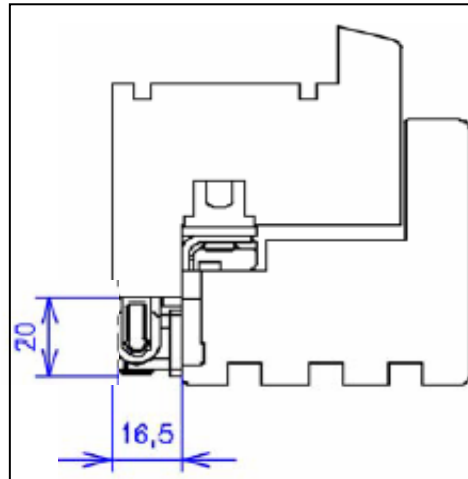
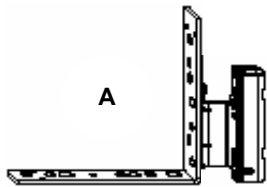

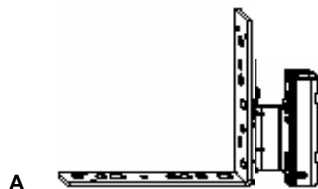
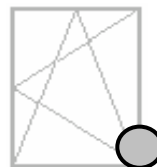

	N ID	Balama cercevea jos DT cu fixare pe inaltimea etansarii (Ü) 130 kg.	UZ	Culoare	Parametrii	
A	54684	dreapta-Balama toc jos DT cu suport axa 9 mm	prag AL	argintiu	18Ü/12L	50
	54685	stanga- Balama toc jos DT cu suport axa 9 mm	prag AL	argintiu	18Ü/12L	50
	54688	dreapta-Balama toc jos DT cu suport axa 9 mm	prag AL	argintiu	20Ü/12L	50
	54689	stanga- Balama toc jos DT cu suport axa 9 mm	prag AL	argintiu	20Ü/12L	50

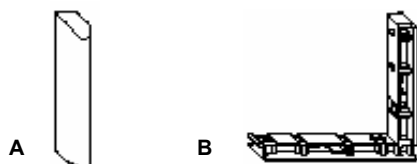

	N ID	Capac pentru balama cercevea jos DT cu fixare pe inaltimea etansarii (Ü)			
	Dreapta	Stanga			
A	43587	43588	alb	capac balama cercevea jos DT	50
	43590	43601	bronz	capac balama cercevea jos DT	100
	43591	43602	auriu-stralucitor	capac balama cercevea jos DT	100
	43592	43603	titan	capac balama cercevea jos DT	100
	43593	43604	sampanie	capac balama cercevea jos DT	100
	43597	43608	argintiu	capac balama cercevea jos DT	100
	43595	43606	maro	capac balama cercevea jos DT	100
	44246	44247	crom-stralucitor	capac balama cercevea jos DT	50
	43598	43609	crem	capac balama cercevea jos DT	100
B	44234	Suport adaptor pentru balama cercevea jos DT cu fixare pe inaltimea etansarii (Ü)			100

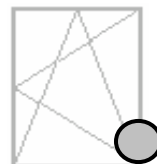

Informatii tehnice

Balama toc jos TO

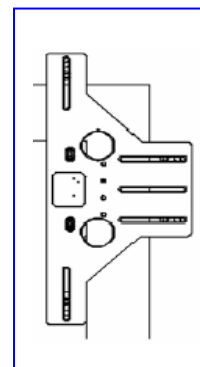
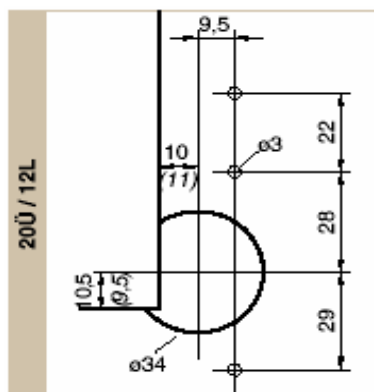
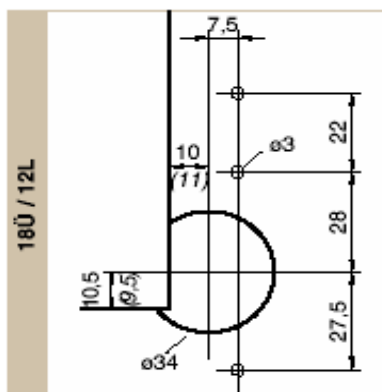
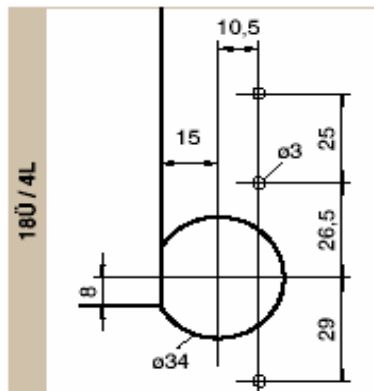
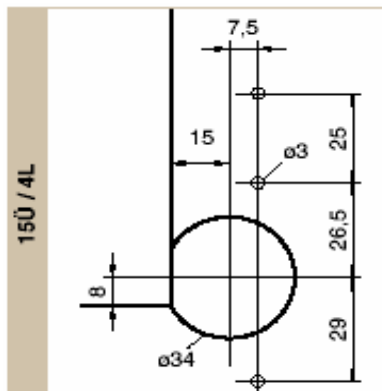
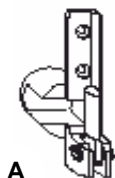

sablon	sistem	Fr.	i.ex.
22016	15Ü / 4L	ø 16	ø 27
21723	15Ü / 4L	ø 34	ø 40
21724	18Ü / 4L	ø 34	ø 40
21725	18Ü / 12L	ø 34	ø 40
21726	20Ü / 12L	ø 34	ø 40

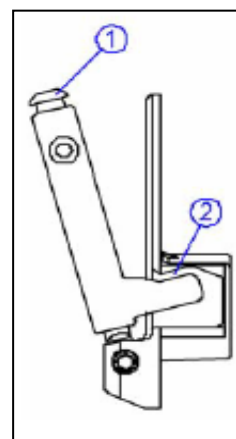
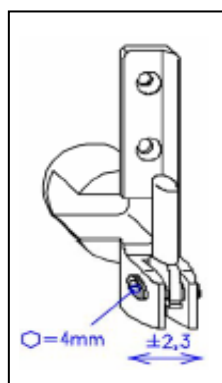
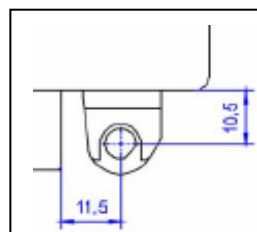
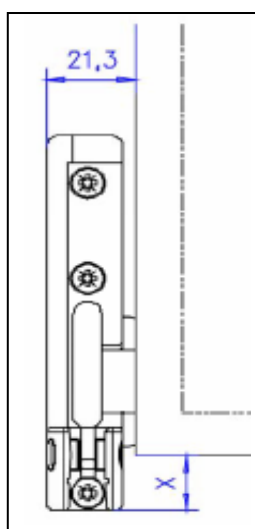

15Ü/4L: x=15,5 mm
 18Ü/4L: x=11,5 mm
 18Ü/12L: x=15,5 mm
 20Ü/12L: x= 13,5 mm

Balama cercevea sus TO

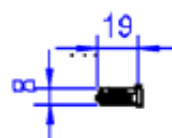

Sablon Nr.- 28780

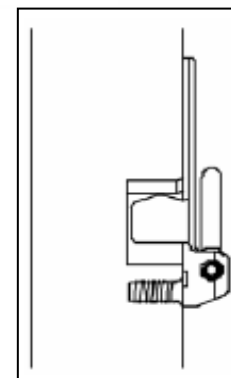

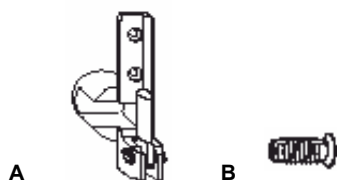
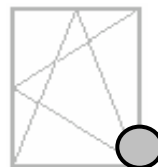

	N ^o	Balama toc jos TO	130 kg.	Culoare	Parametrii	
A	55412	dreapta	Balama toc jos TO	argintiu	15Ü/4L	50
	55413	stanga	Balama toc jos TO	argintiu	15Ü/4L	50
	55237	dreapta	Balama toc jos TO	argintiu	18Ü/4L	50
	55238	stanga	Balama toc jos TO	argintiu	18Ü/4L	50
	52399	dreapta	Balama toc jos TO	argintiu	18Ü/12L	50
	52398	stanga	Balama toc jos TO	argintiu	18Ü/12L	50
	54722	dreapta	Balama toc jos TO	argintiu	20Ü/12L	50
	54723	stanga	Balama toc jos TO	argintiu	20Ü/12L	50
	52511	dreapta	Balama toc jos TO	alb	15Ü/4L	50
	52512	stanga	Balama toc jos TO	alb	15Ü/4L	50
	22520	dreapta	Balama toc jos TO	alb	18Ü/12L	50
	22522	stanga	Balama toc jos TO	alb	18Ü/12L	50
B	36668	Surub pentru balama toc jos TO 100 -130 kg.				50

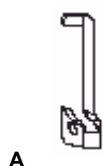

	N ^o	Capac pentru balama toc jos TO			
A	Dreapta	Stanga			
	40345	40346	alb	capac balama toc jos TO	50
	41612	41613	bronz	capac balama toc jos TO	50
	40489	40490	alama	capac balama toc jos TO	50
	40762	40764	titan	capac balama toc jos TO	50
	41692	41691	sampanie	capac balama toc jos TO	50
	41202	41203	maro	capac balama toc jos TO	50

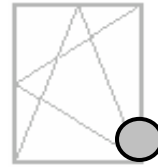

Informatii tehnice

Balama cercevea jos DT

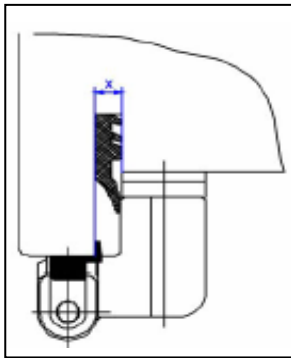
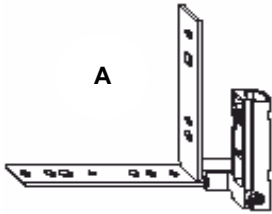

Pozitionarea balamalei atunci cand nu s-a practicat nutul pentru feronerie

x	Nr. sablon
4	40491
5	40492
6	40493

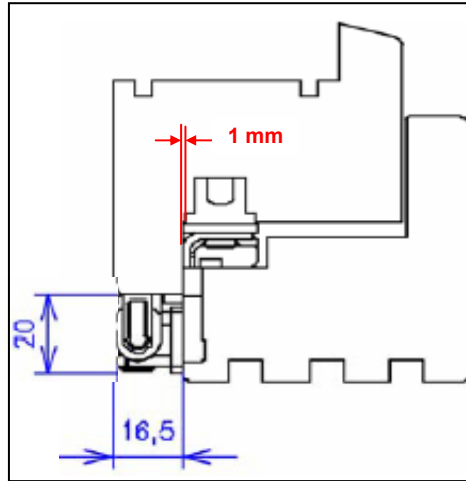

Dimensiuni de gabarit

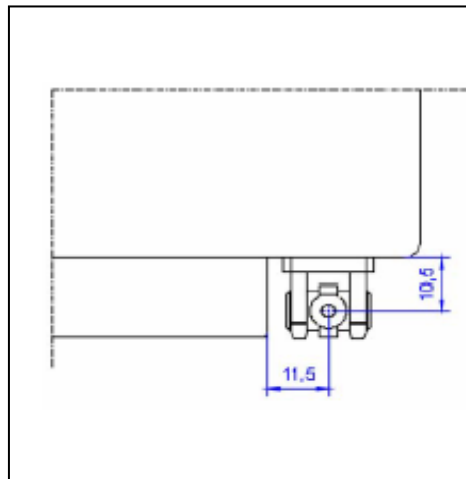
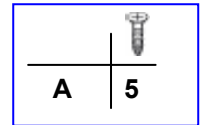

Centrul de pivotare

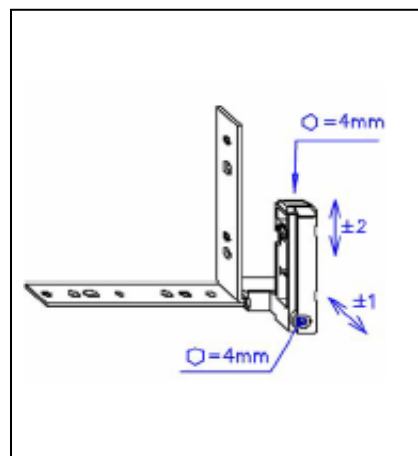
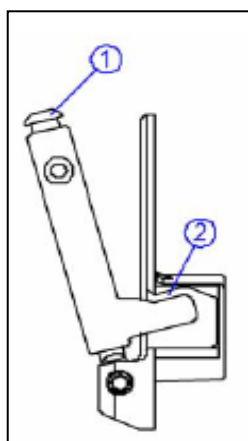

Reglajul

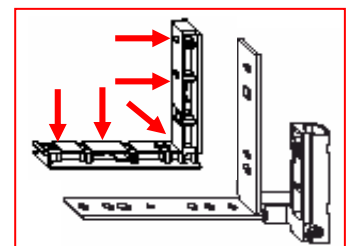

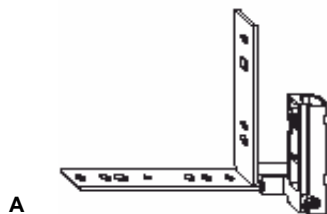
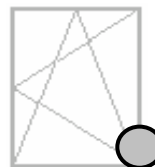

	N ₀	Balama cercevea jos TO	130 kg.	Culoare	Parametrii	
A	52394	dreapta	Balama cercevea jos TO	argintiu	18U/11L	50
	52395	stanga	Balama cercevea jos TO	argintiu	18U/11L	50
	54724	dreapta	Balama cercevea jos TO	argintiu	20U/12L	50
	54725	stanga	Balama cercevea jos TO	argintiu	20U/12L	50
B	40485	Suport adaptor balama cercevea jos				50
	40486	Suport adaptor pentru balama cercevea jos - pt distanta de 1 mm				50

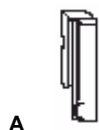

	N ₀	Capac pentru balama jos TO			
	Dreapta	Stanga			
A	40343	40344	alb	capac balama cercevea jos TO	50
	41614	41615	bronz	capac balama cercevea jos TO	50
	40460	40462	alama	capac balama cercevea jos TO	50
	40758	40759	titan	capac balama cercevea jos TO	50
	41694	41693	sampanie	capac balama cercevea jos TO	50
	41204	41205	maro	capac balama cercevea jos TO	50





Deschidere Batanta

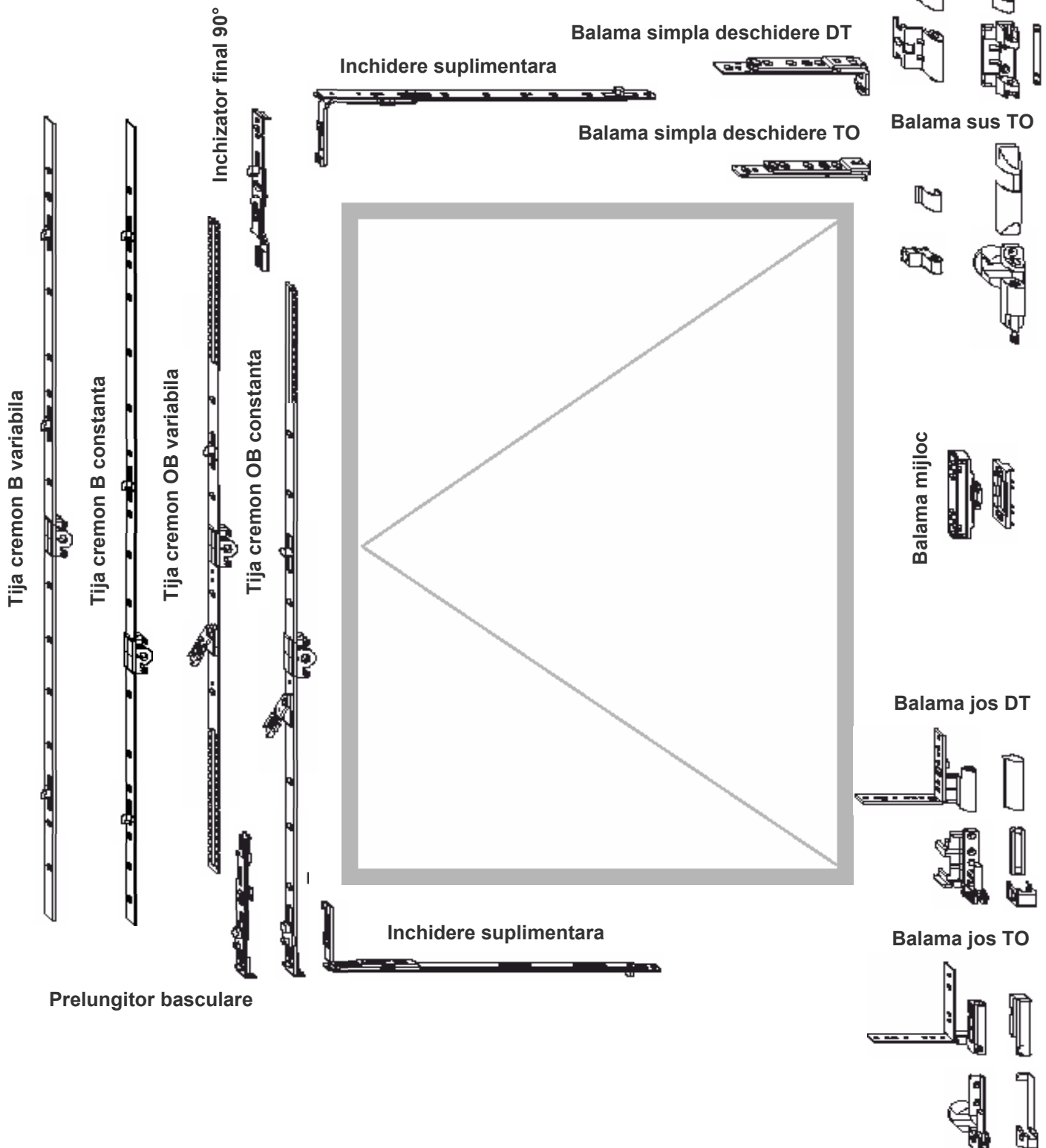

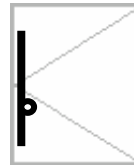

Informatii tehnice

Tija cremon constanta DM 15

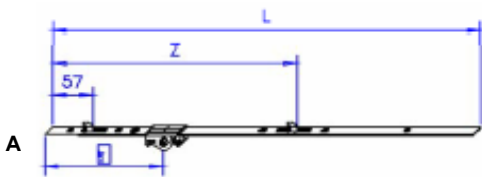

Gr.1	4
Gr.2	6
Gr.3	7

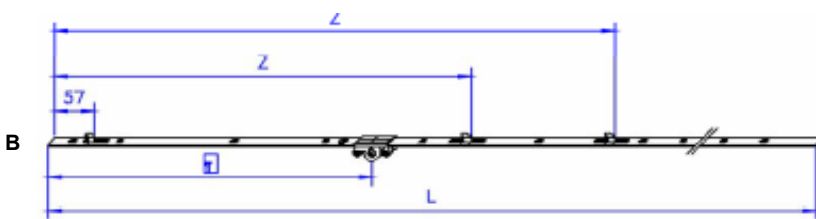

Gr.4	10
Gr.5	10
Gr.7	11

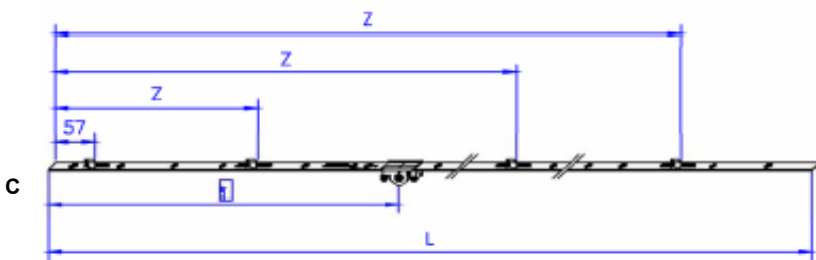

Gr.9	11
Gr.10	11
Gr.11	12
Gr.12	12

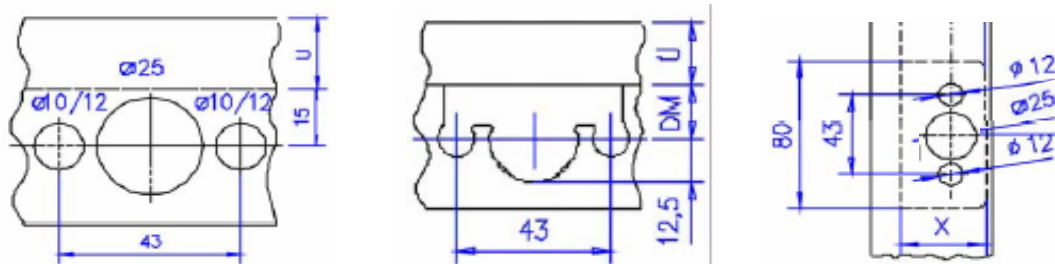



$x = DM + 12,5 \text{ mm}$

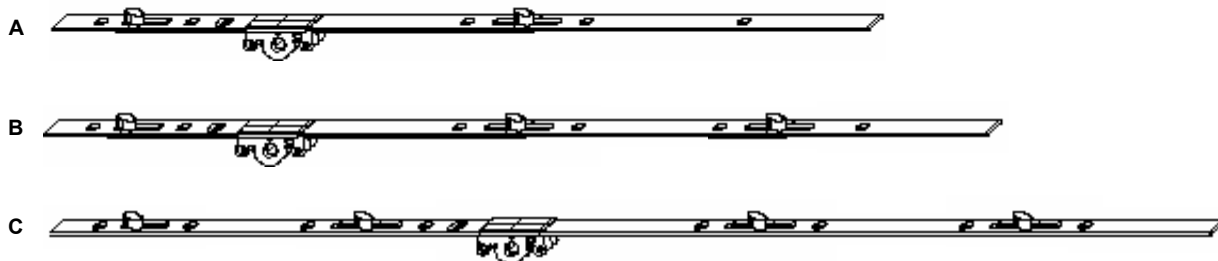
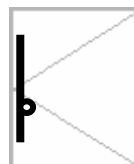

	31	100	310	400	520								
Gr.1	31	100	310	400	520								
Gr.2	31	100	230	370	570	650	720						
Gr.3	31	100	330	470	630	770	850	920					
Gr.4	31	100	265	430	570	770	970	1060	1150	1240			
Gr.5	31	100	320	530	670	840	1010	1170	1240	1330			
Gr.6	31	100	320	530	670	895	1120	1340	1420				
Gr.7	31	100	280	460	630	770	1005	1240	1470	1540	1630		
Gr.8	31	100	320	460	460	770	990	1205	1425	1640	1720		
Gr.9	31	100	320	540	760	980	1153	1370	1570	1770	1865	1955	
Gr.10	31	100	320	540	760	980	1153	1370	1570	1770	1970	2065	2156
Gr.11	31	100	320	540	760	980	1153	1370	1570	1770	1970	2170	2250
Gr.12	31	100	320	540	760	980	1153	1345	1535	1725	1915	2093	2340



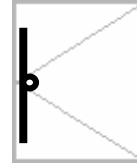

	Argintiu N	Tija cremon B constanta, DM 15 mm	Z	L			
A	55363	Gr. 1	355	620	400 - 600	170	20
	55364	Gr. 2	525	820	601 - 800	300	20
	57845	Gr. 3A	725	1020	800 - 1000	300	10
	55365	Gr. 3	725	1020	801 - 1000	400	20
B	55366	Gr. 4	635 / 925	1320	1001 - 1300	500	10
	57846	Gr. 4B	635 / 925	1320	1001 - 1300	400	10
	55367	Gr. 5	735 / 1125	1520	1251 - 1500	600	10
	57847	Gr. 5A	735 / 1125	1520	1300 - 1500	400	10
	57850	Gr. 5B	735 / 1125	150	1300 - 1500	500	10
	55368	Gr. 7	835 / 1425	1820	1501 - 1800	700	10
C	57851	Gr. 7A	835 / 1425	1820	1501 - 1800	500	10
	57848	Gr. 7B	835 / 1425	1820	1501 - 1800	400	10
	55131	Gr. 9	635 / 1370 / 1770	2020	1801 - 2000	1050	10
	57852	Gr. 9A	635 / 1370 / 1770	2020	1801 - 2000	500	10
	57849	Gr. 9B	635 / 1370 / 1770	2020	1801 - 2000	400	10
	55132	Gr. 10	635 / 1370 / 1925	2220	2001 - 2200	1050	10
	55133	Gr. 11	635 / 1370 / 2170	2420	2201 - 2400	1050	10
	57861	Gr. 12	635 / 1370 / 2295	2600	2401 - 2600	1050	10



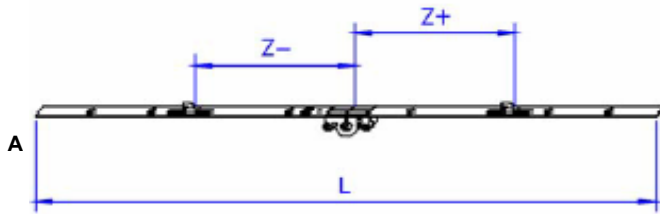

Informatii tehnice

Tija cremon variabila DM 15

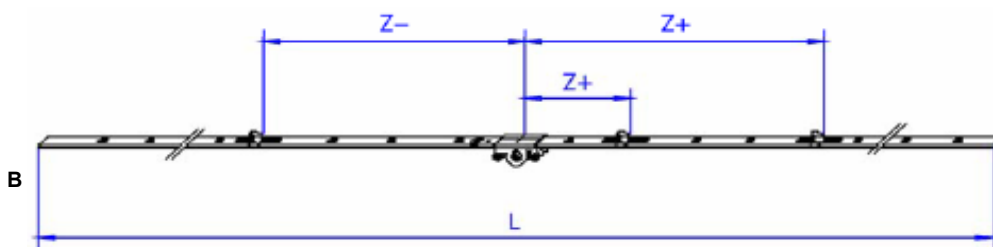

	
Gr.1	4
Gr.2	6
Gr.3	7



	
Gr.4	10
Gr.5	10

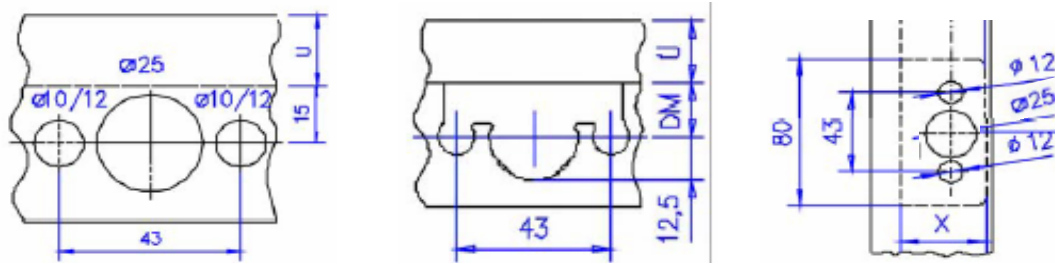





x = DM+12,5 mm

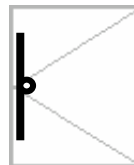

	←						→					
Gr.1					185	115	115	185				
Gr.2				300	230	70	70	230	300			
Gr.3				420	330	70	70	330	420			
Gr.4		640	560	480	270	70	70	270	480	560	640	
Gr.5	840	760	680	480	280	70	70	280	480	680	760	840

MACO MULTI TREND

	Argintiu N 	Tija cremon B variabila, DM 15 mm	Z +	Z -	L		
A	52463	Gr. 1	70	70	520	300 - 500	10
	52464	Gr. 2	185	185	720	501 - 700	10
	52465	Gr. 3	285	285	1020	701 - 1000	10
B	52466	Gr. 4	135/435	435	1420	1001 - 1400	10
	55037	Gr. 5	135/635	635	1820	1401 - 1800	10



Informatii tehnice

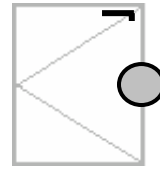

Balama pentru simpla deschidere DT

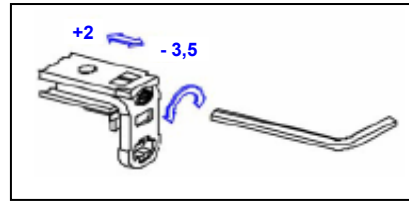
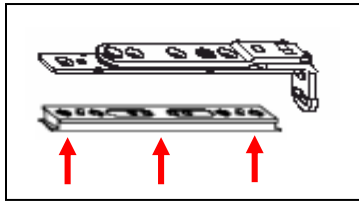
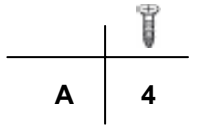
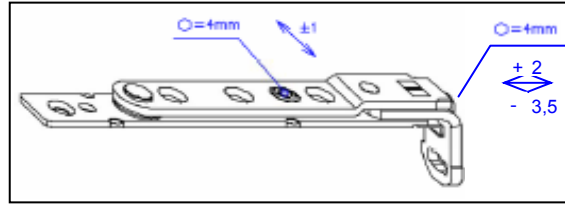
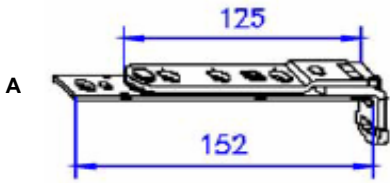

Balama pentru simpla deschidere TO

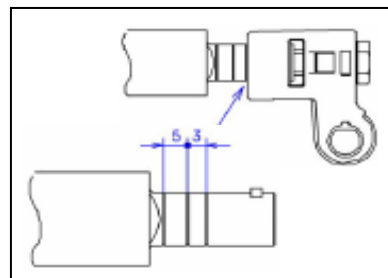
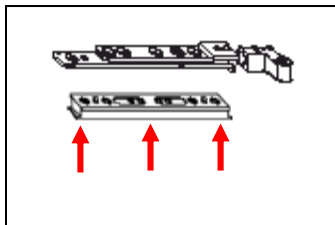
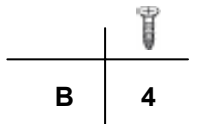
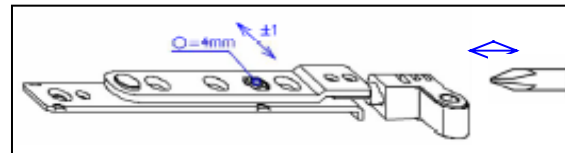
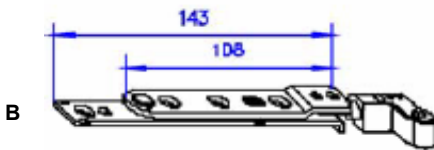

c Balama antiflambaj aparenta

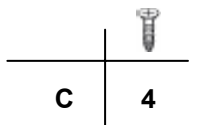
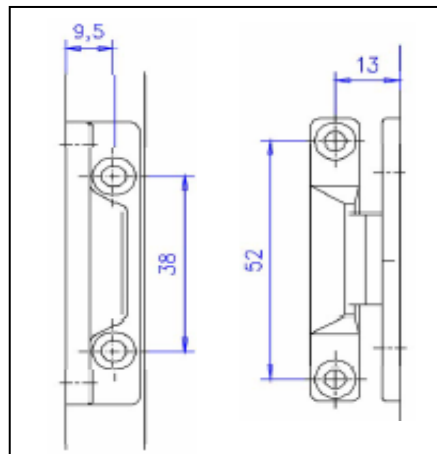

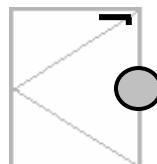



A



B



C

	Argintiu N ₀	Balama pentru simpla deschidere	
A	52702	Balama simpla deschidere DT	50
B	54777	Balama simpla deschidere TO	50
	54718	Balama simpla deschidere TO	50
C	41103	Suport pentru balama simpla deschidere DT / TO	100





A



B



C



	Argint N ₀	Balama de mijloc	
A	52467	Balama mijloc cercevea - ascunsa	100
B		Balama mijloc toc - ascunsa	100
		vezi pagina piese inchidere	
C	52389	Balama antiflambaj - aparenta	100
	55028	Balama antiflambaj - aparenta - pentru suprapunere cu garnitura	100



A Cercevea



Toc

	N ₀	Capac balama antiflambaj	
		Cercevea	
		Toc	
A	41339	41342 alb	100
	41582	41583 bronz	100
	40553	40551 alama	100
	40757	40756 titan	100
	41699	41701 sampanie	100
	43568	43569 argintiu	100
	41231	41233 crem	100
	41340	41343 maro	100
	44236	44235 crom	100





Deschidere Basculanta

Foarfece limitare basculare



Tija cremon B variabila



Tija cremon OB variabila

Coltar

Coltar

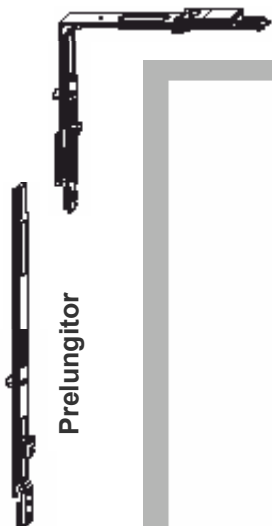

Prelungitor

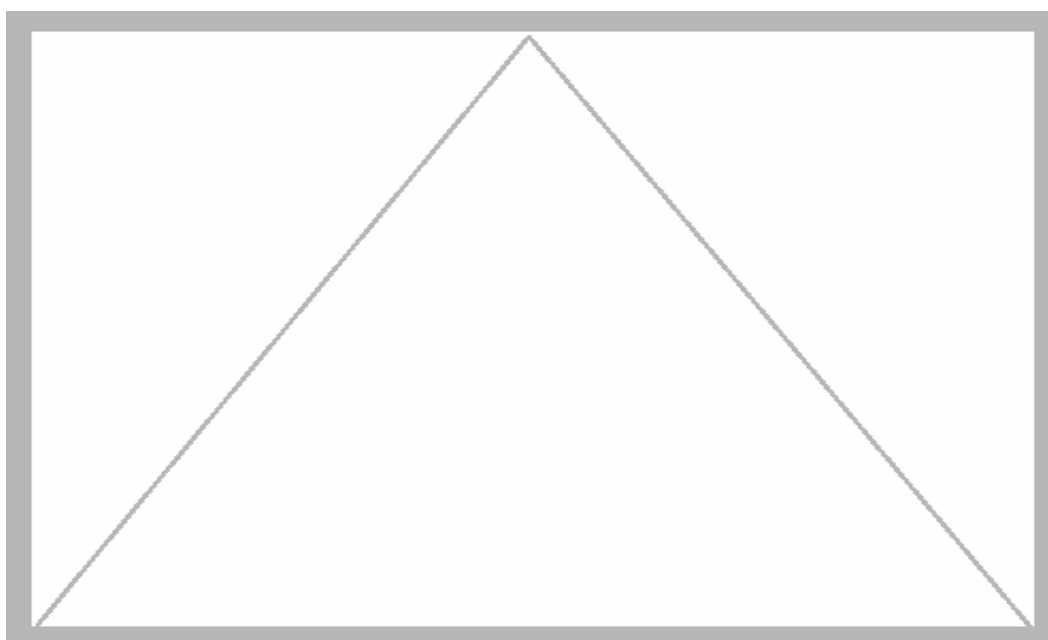

Prelungitor

Balama basculare DT



Balama basculare TO

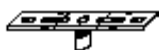

Balama basculare TO



Balama basculare DT



Balama cercevea DT



Balama cercevea TO



Balama cercevea TO



Balama cercevea DT



Balama toc DT



Balama toc TO



Balama toc TO



Balama toc DT



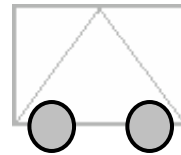

Informatii tehnice

A Balama basculanta DT reglabila

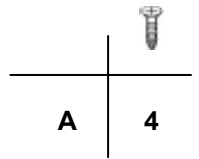
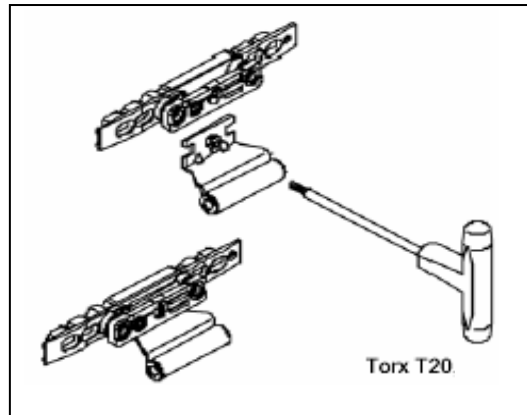
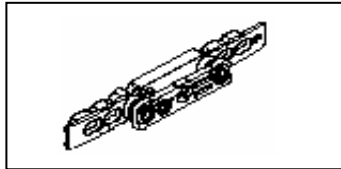

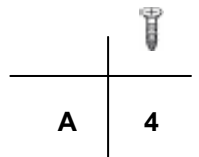
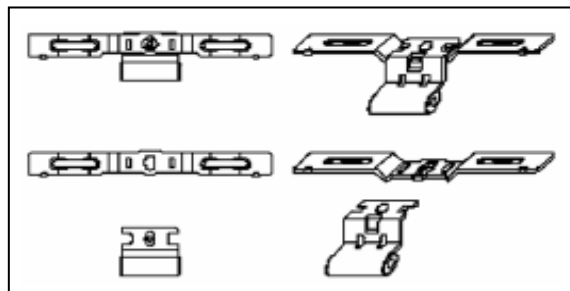
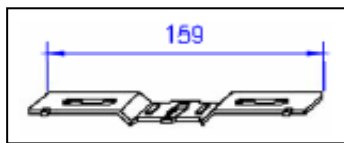

B Balama basculanta DT

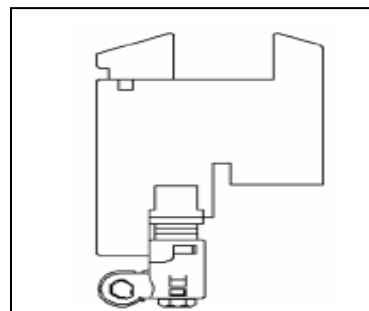
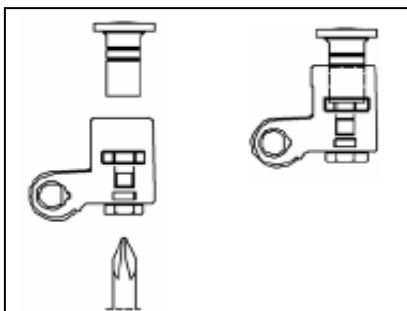
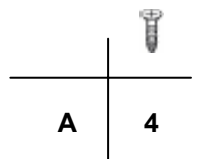
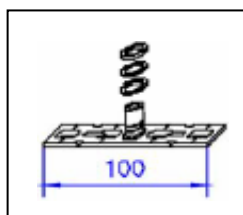

c Balama basculanta TO

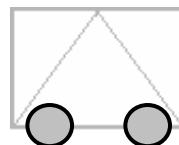



H	Argintiu N III C	Balama pentru basculare	
A	52321	Balama basculanta DT reglabila	50
B	52468	Balama basculanta DT	50
C	54775	Balama basculanta TO	100

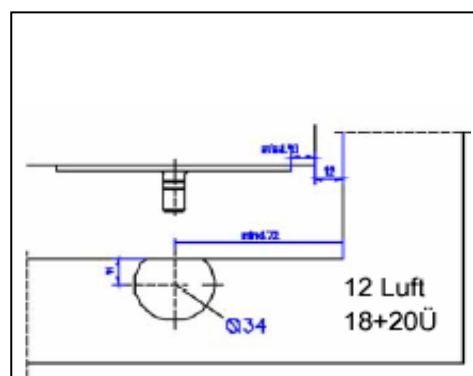
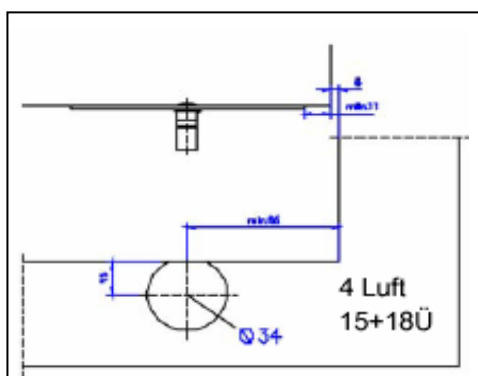
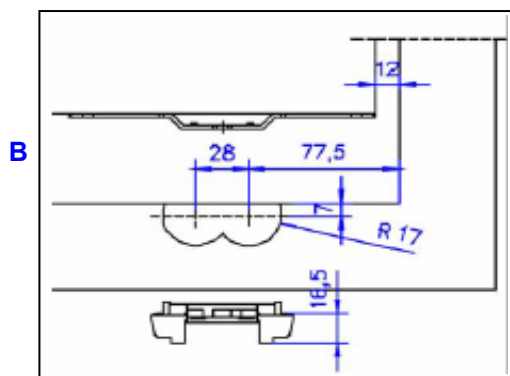
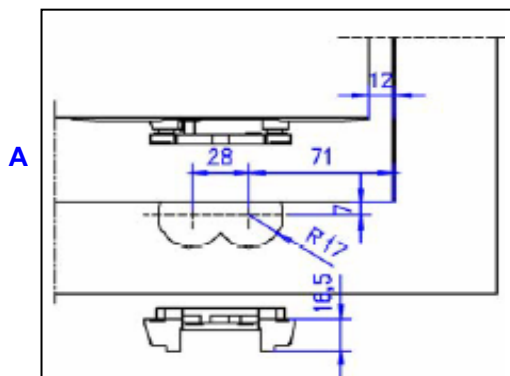

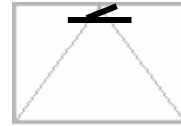

Informatii tehnice

Foarfece limitare basculare

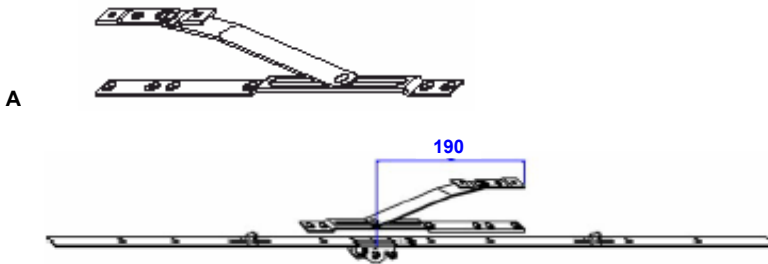

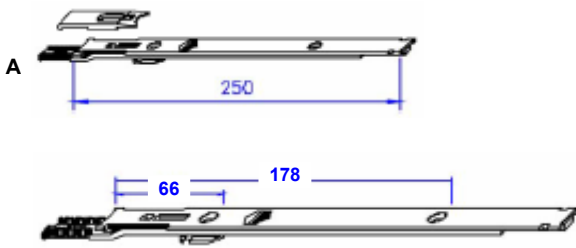

	
A	4

Prelungitor

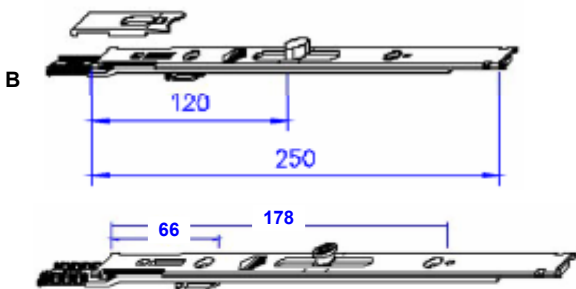

	
A	3



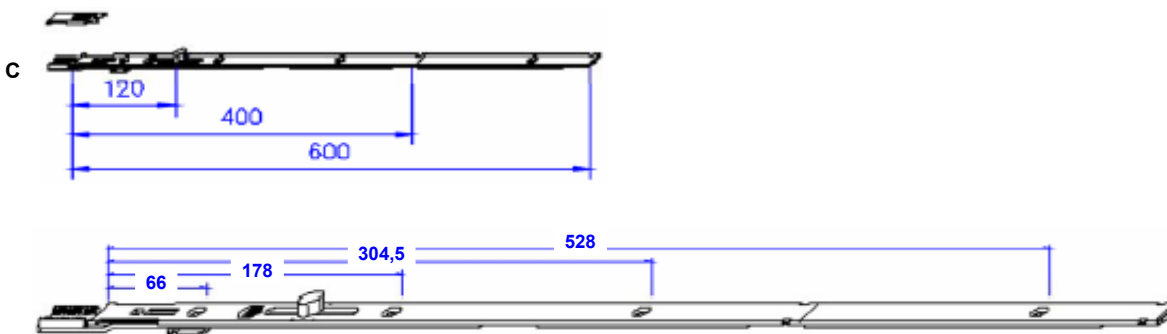

	
B	3

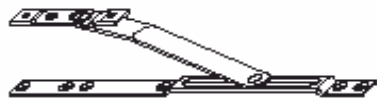

	
C	5



A





	Argintiu N 	Foarfeca pentru limitarea bascularii	
A	52469	Foarfeca limitare basculare	20



A

B

C

	Argintiu N 	Prelungitor			
A	10585	250 mm	400 - 1650	370 - 2350	20
B	10586	250 mm cu rola de inchidere	280 - 650	370 - 2350	20
C	55876	600/400 mm cu rola de inchidere	400 - 1400	370 - 2350	20





Canatul cu Stulp

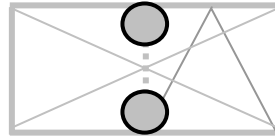

Balama sus DT

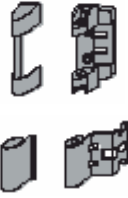

Balama simpla deschidere DT



Balama sus TO

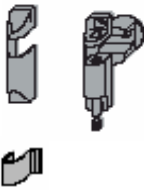

Balama simpla deschidere TO



Balama mijloc



Balama jos DT

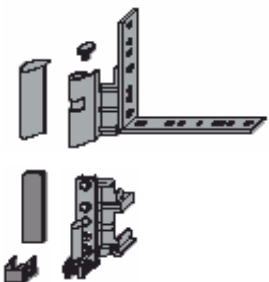

Balama jos TO

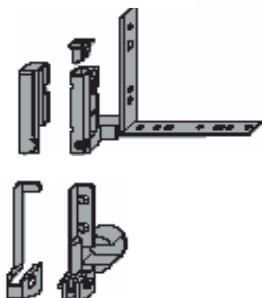

Piesa inchidere zavor



Inchidere suplimentara

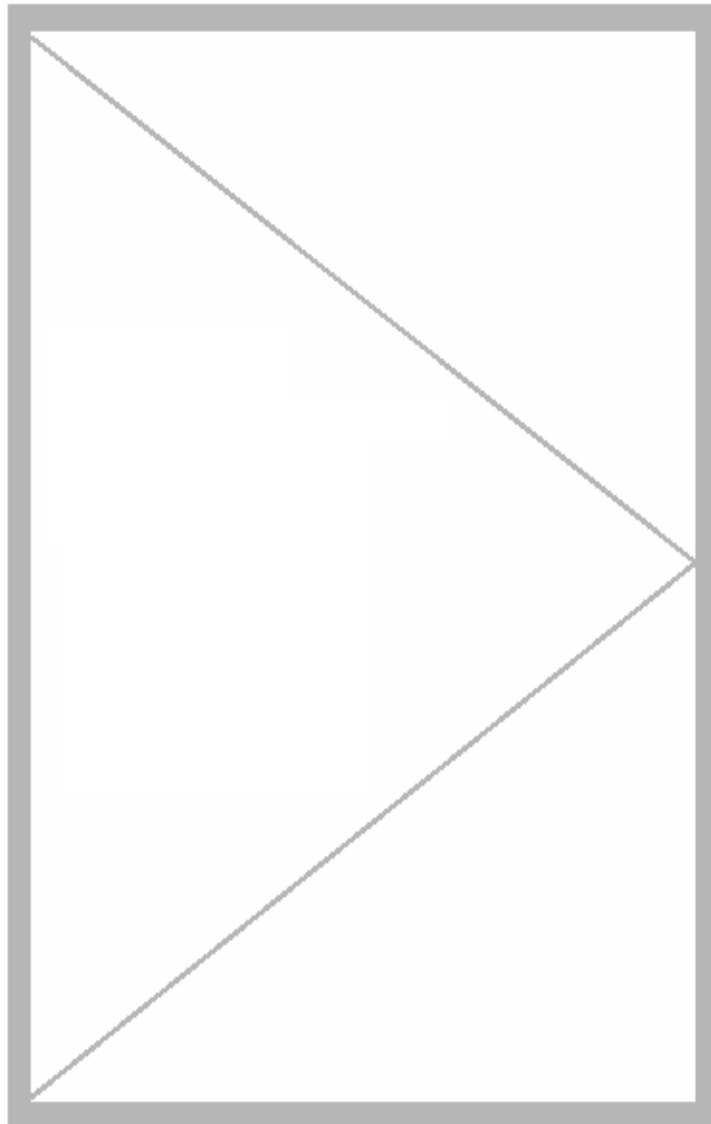

Tija inchidere stulp

Zavor sus

Tija cremon

Zavor jos

Inchidere suplimentara



Piesa inchidere zavor



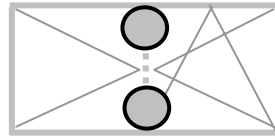

Informatii tehnice

Zavor

zavorare pentru Euronut

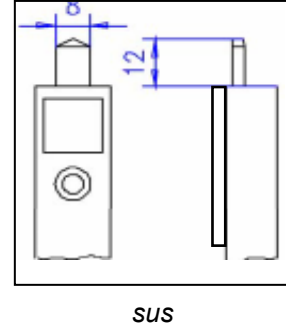
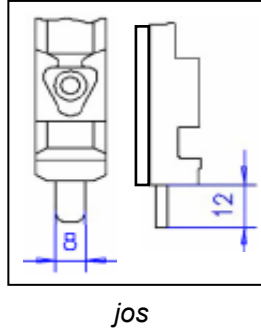
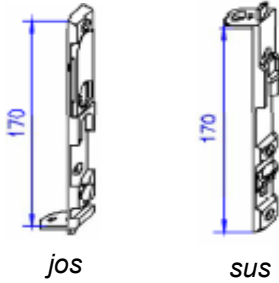

zavorare pentru Eurofalt

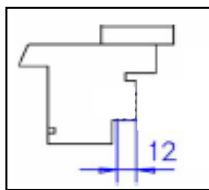
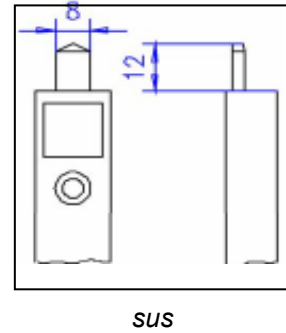
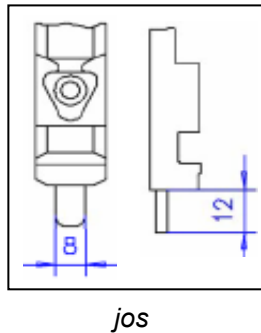
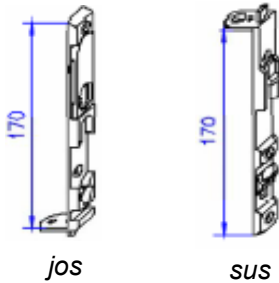

Eurofalt 12 mm

zavorare pentru Luft 4mm

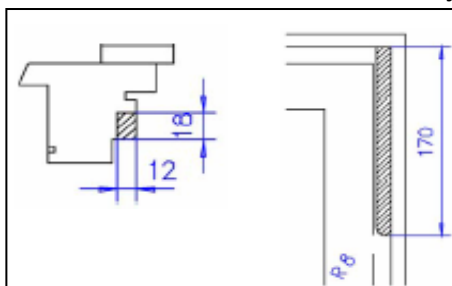
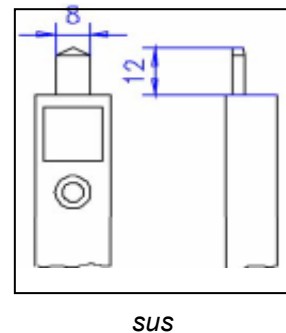
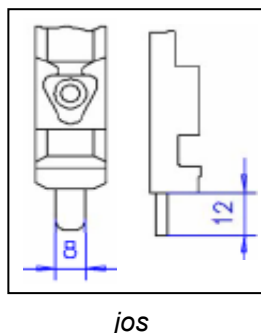
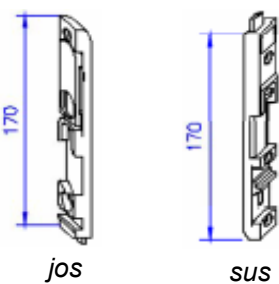

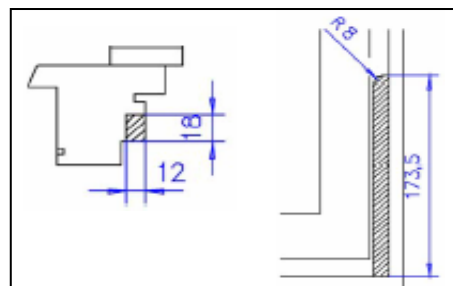

sus

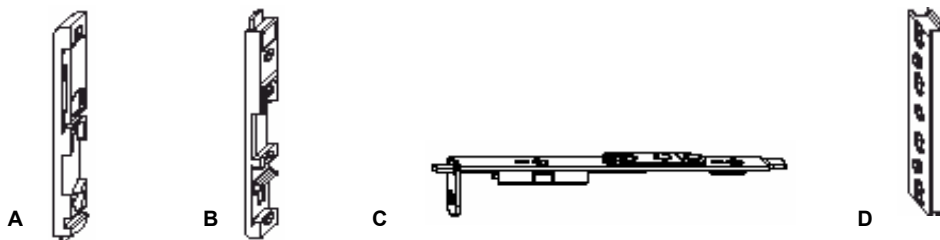
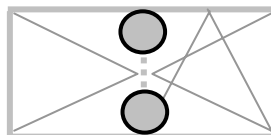

jos



	Argintiu N	Zavor		
A	52504	zavor jos Euronut	370 - 2600	20
	55167	zavor jos Eurofalt 12 mm	370 - 2600	20
	55409	zavor jos pentru Luft 4 mm	370 - 2600	20
B	52505	zavor sus Euronut	430 - 2600	20
	55362	zavor sus Eurofalt 12 mm	430 - 2600	20
	55430	zavor sus pentru Luft 4 mm	430 - 2600	20
C	57300	zavor plat - jos / sus pentru Euronut	-	20
D	41263	suport pentru zavor	-	100

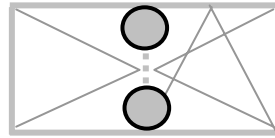

Informatii tehnice

Tija inchidere stulp "EURONUT" constanta

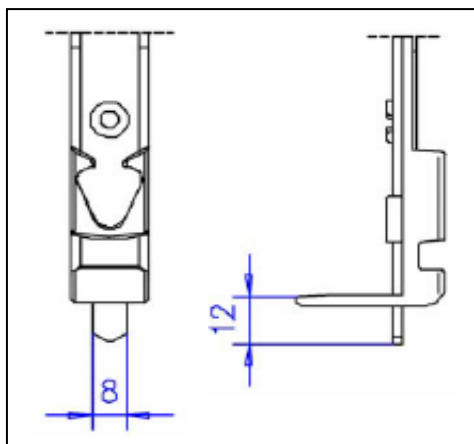
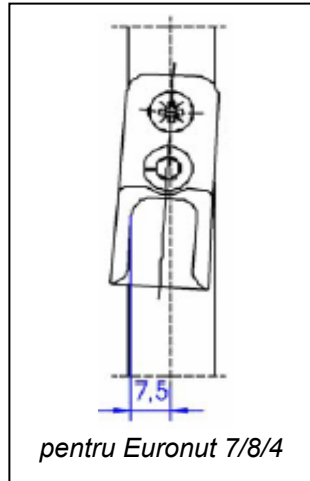
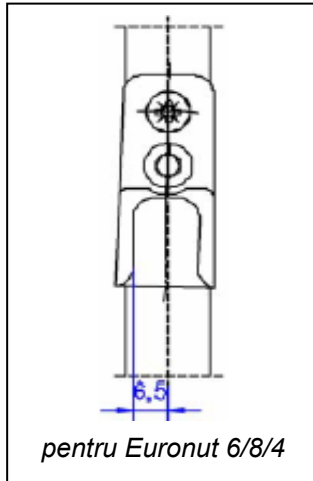

dimensiunile tije de inchidere

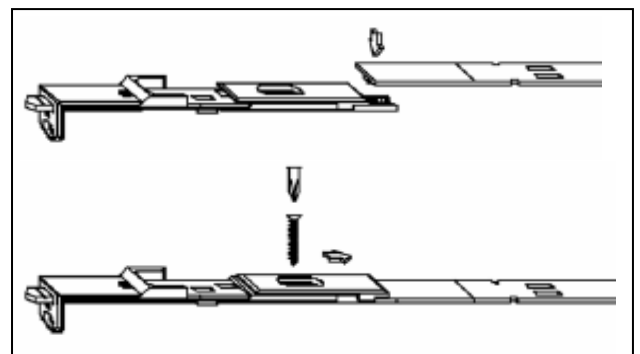



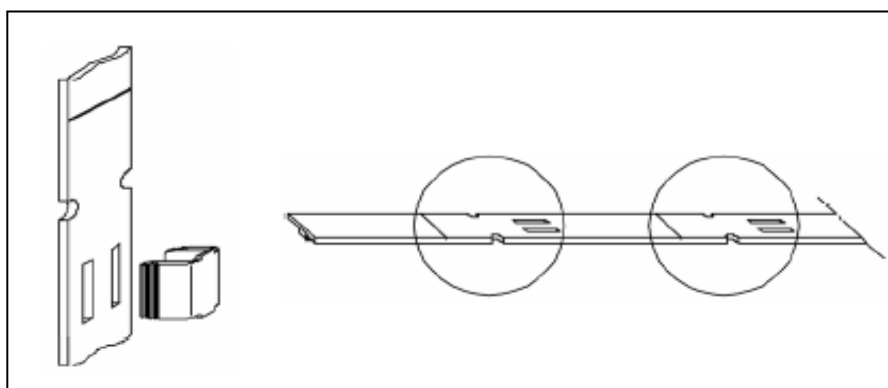

cuplarea cu zavorul superior

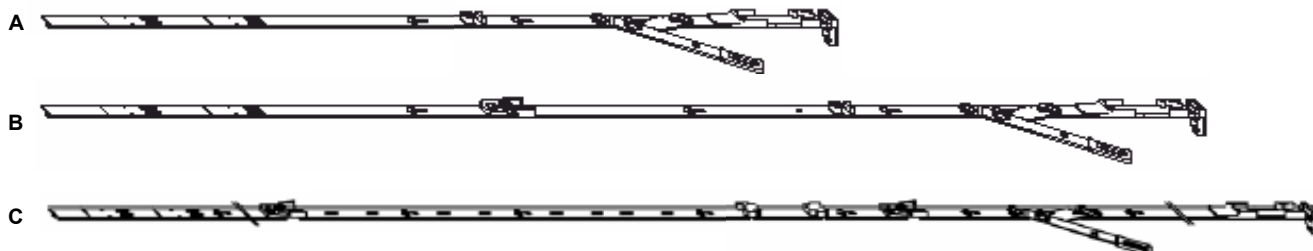
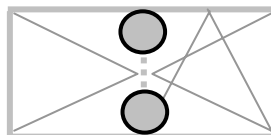

centrarea cremalierii



	Argintiu N ₁₀	Tija inchidere stulp "EURONUT" constanta	L			
A	52832	Gr. 1	630	300	550 - 800	10
B	52833	Gr. 2A cu piesa de inchidere	910	400	801 - 1000	10
	203058	Gr. 2C	1153	400	1050 - 1300	10
	52834	Gr. 3	1110	500	1001 - 1250	10
	52835	Gr. 4A	1360	500	1251 - 1500	10
	55168	Gr. 4	1360	600	1251 - 1500	10
	52836	Gr. 5	1610	700	1501 - 1750	10
C	54594	Gr. 6A	1620	1050	1661 - 1850	10
	52837	Gr. 6	1960	1050	1851 - 2100	10
	52838	Gr. 7	2210	1050	2101 - 2350	10

Gr.	Gr.1	Gr.2A	Gr.2C	Gr.3	Gr.4	Gr.4A	Gr.5	Gr.6A	Gr.6	Gr.7
	3	5	6	7	8	8	10	10	11	13

Informatii tehnice

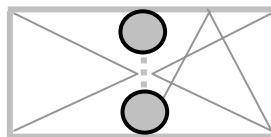

Tija inchidere stulp "EURONUT" variabila

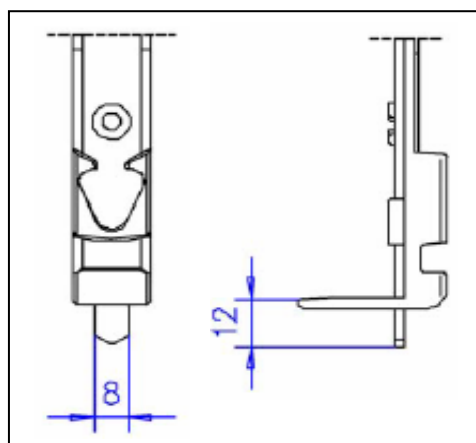
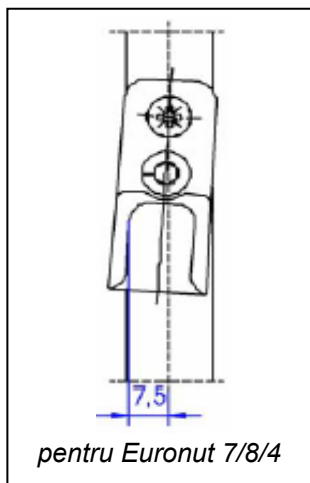
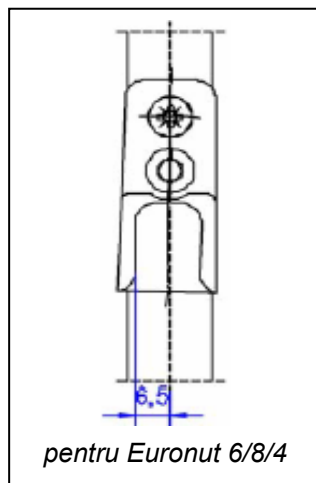
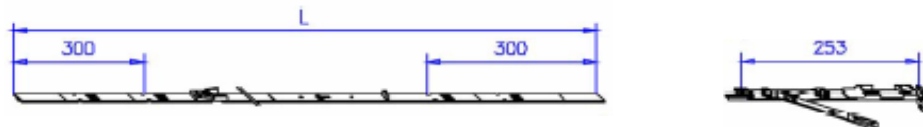

dimensiunile tije de inchidere

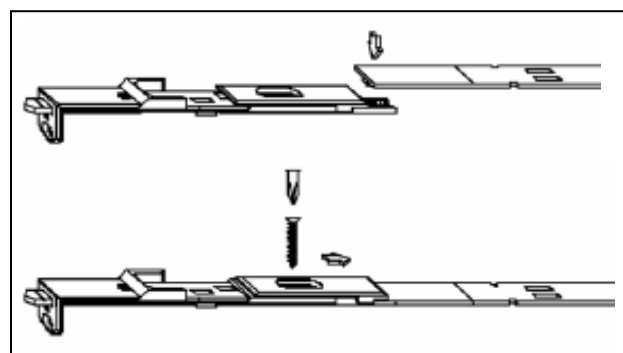



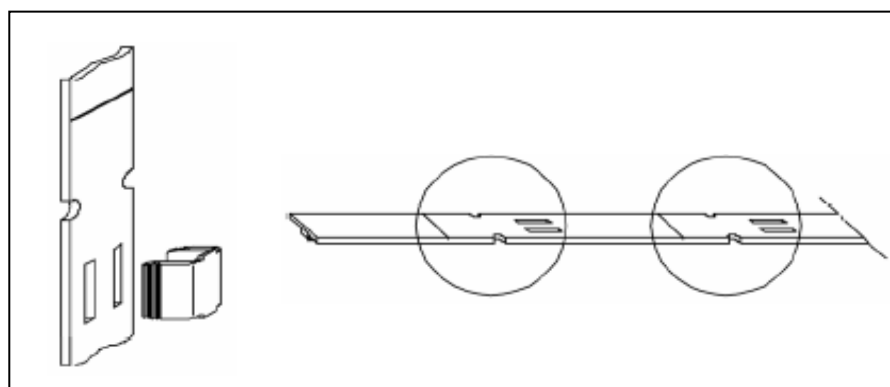

cuplarea cu zavorul superior

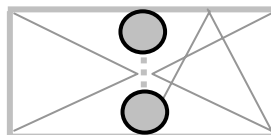

centrarea cremalierii



	Argintiu N 	Tija inchidere stulp "EURONUT" variabila	L		
A	10713	Gr. 3	1071	900 - 1300	10
	10714	Gr. 4	1471	1301 - 1800	10
	52975	Gr. 5	1723	1801 - 2350	10

Gr.	Gr.3	Gr.4	Gr.5
	3	5	6

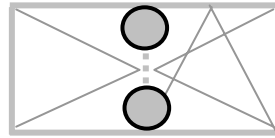
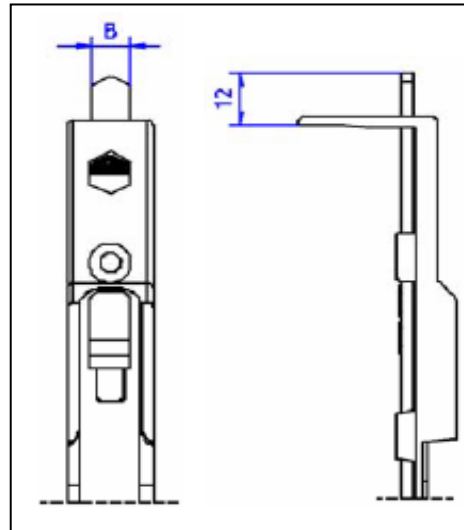
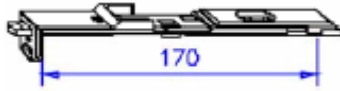
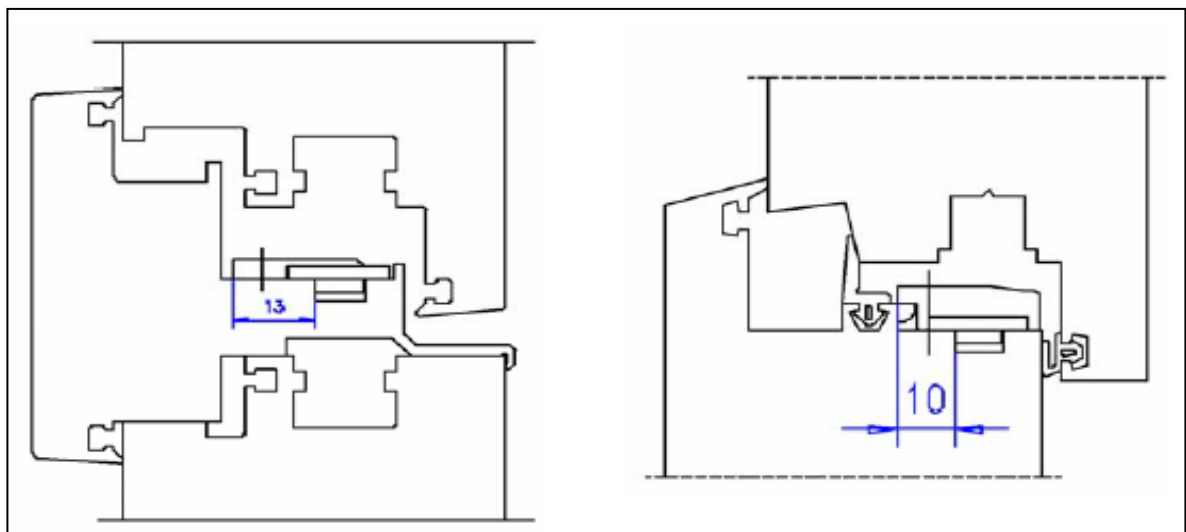
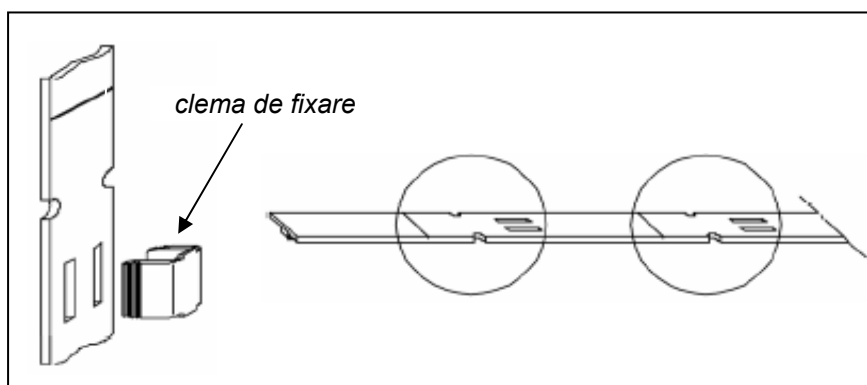
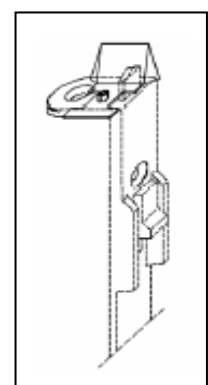
Informatii tehnice**Zavor pentru tija stulp "EURONUT"***dimensiunile tijei de inchidere**spatiul necesar**centrarea cremalierii**capac pt. zavor*

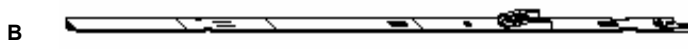
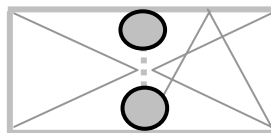

	Argintiu N	Zavor pentru tija stulp "EURONUT"	
A	52839	zavor superior pt. tija stulp "EURONUT" constanta / variabila	20
B	10711	prelungitor "EURONUT" 600/400/250 mm	20
C	43791	capac pentru zavor si tija stulp Euronut	100
D	94035	clema de fixare a cremeliei pentru tija Euronut	100

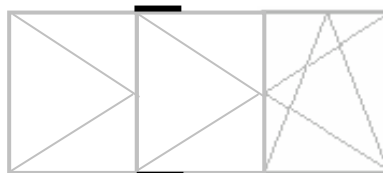
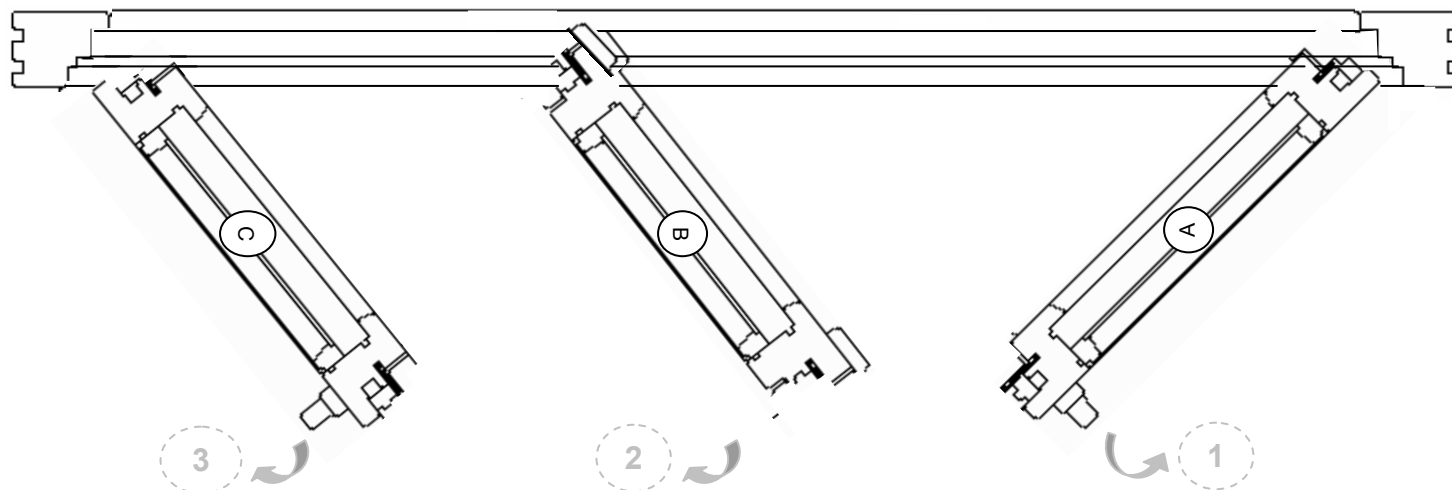
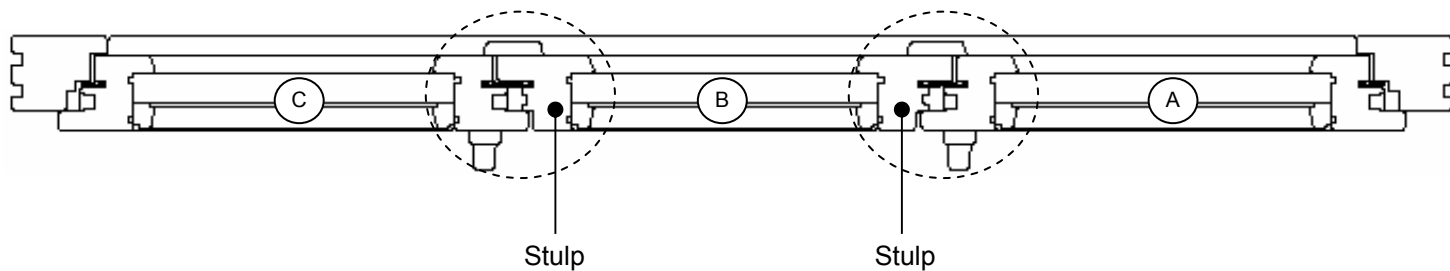
**Fereastra cu trei canaturi fara montant**

- Cerceveaua "A" se poate deschide independent fata de celelalte doua cercevele, pe pozitiile "Batant" sau "Oscilo-Batant".
- Cerceveaua "B" se poate deschide pe pozitia "Batant" numai atunci cand cerceveaua "A" se afla deschisa pe pozitia "Batant".
- Cerceveaua "C" se poate deschide independent fata de celelalte doua cercevele, pe pozitia "Batant".



Balama pentru cerceveaua centrala

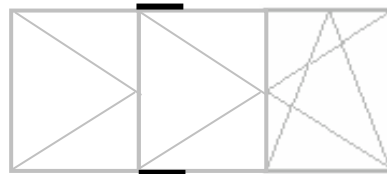

Piesa pt. inchidere zavor



Balama pt.fereastra cu 3 cercevele

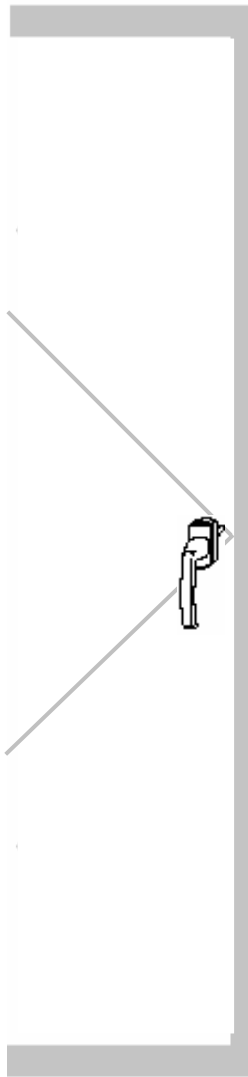
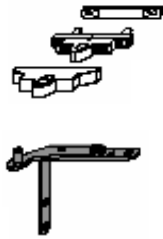

Zavor superior pt. tija cremon B cu inversor

piesa de incuiere - opusa nutului de feroneerie



Tija cremon B constanta, cu inversor

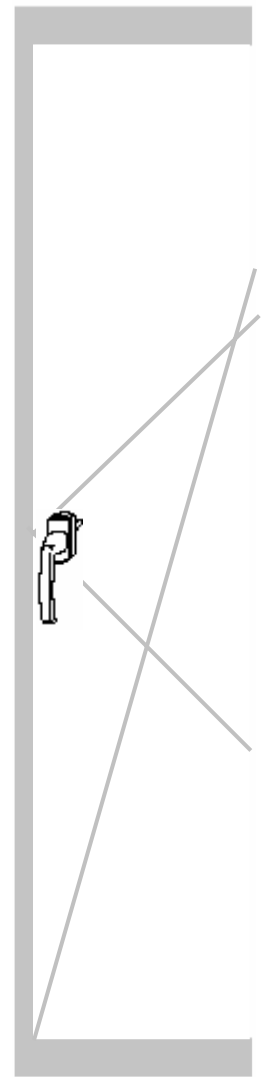
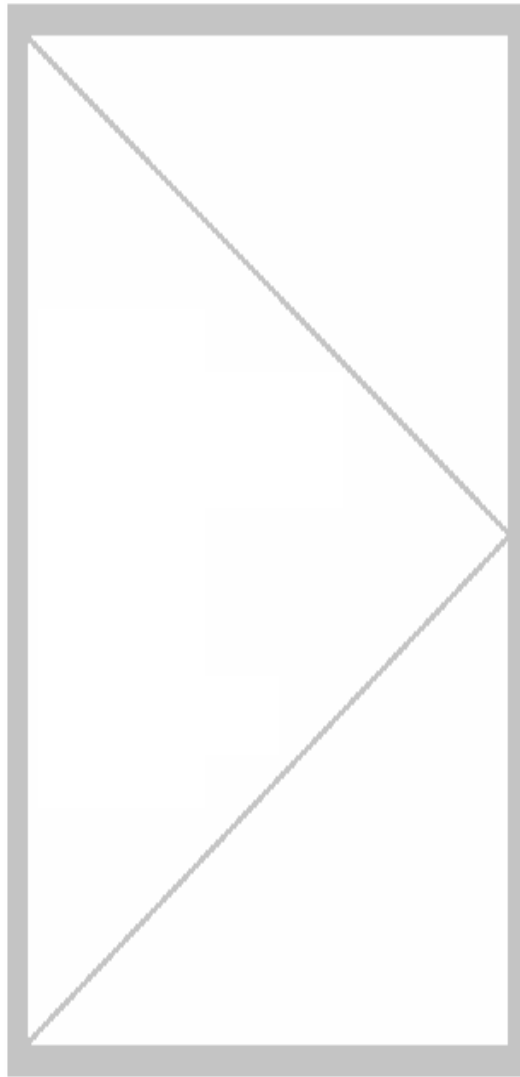

Piesa pt. inchidere zavor



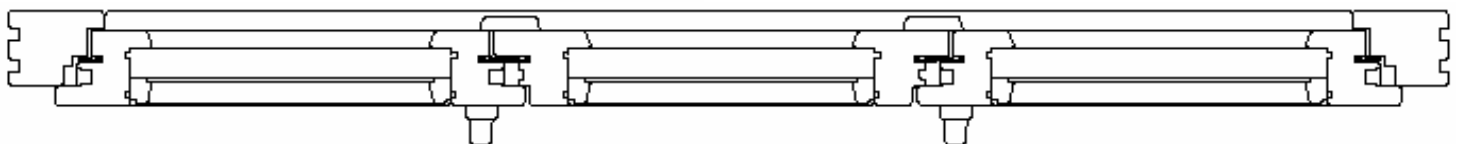
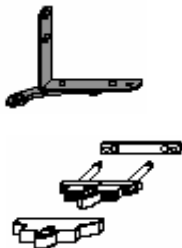

Balama pt.fereastra cu 3 cercevele

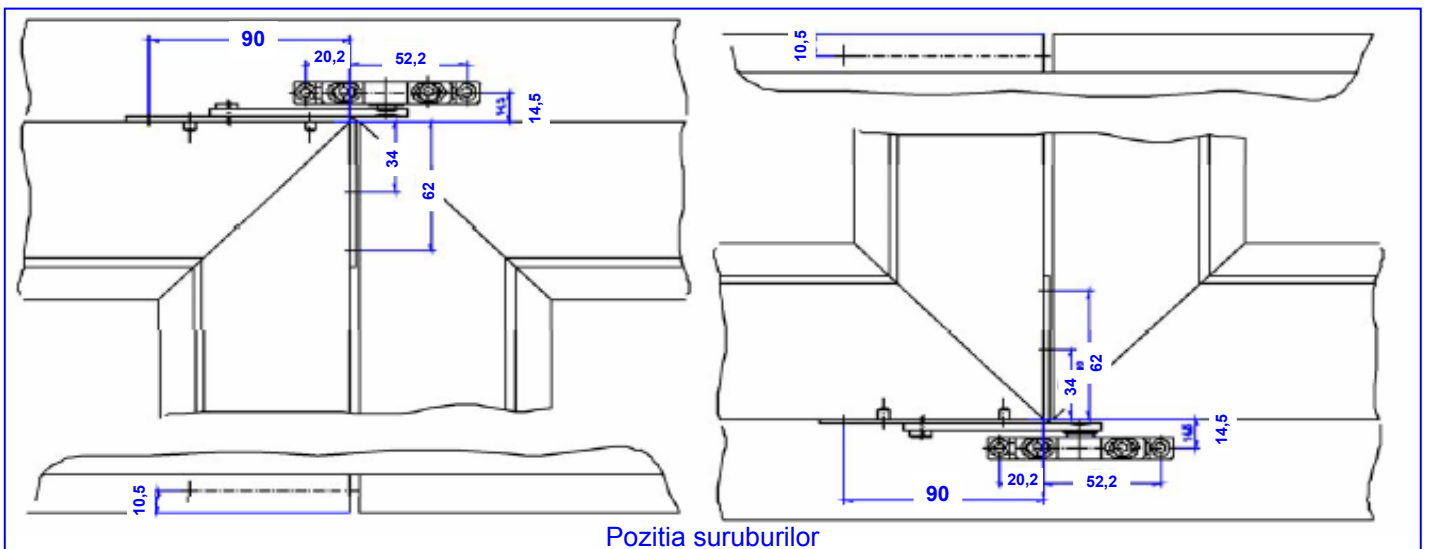
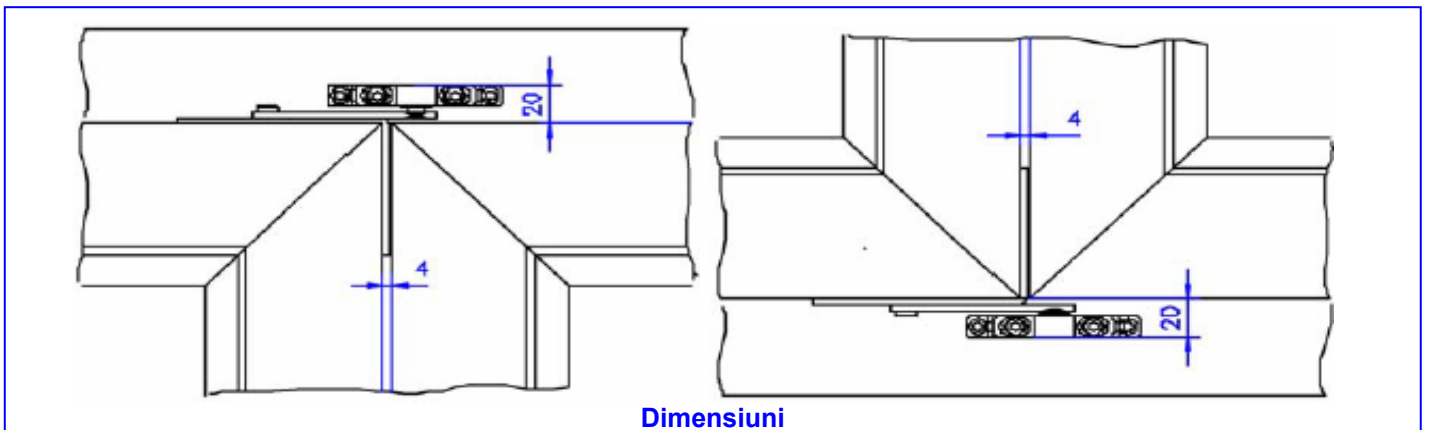
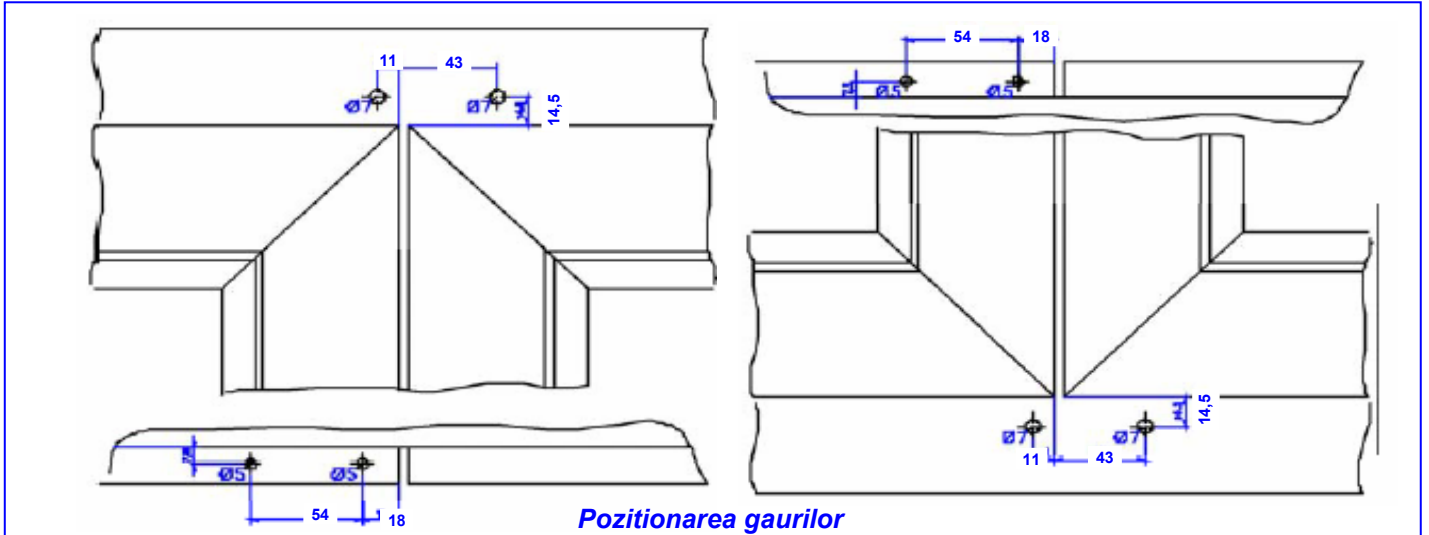
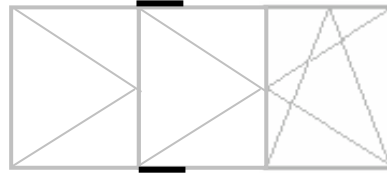

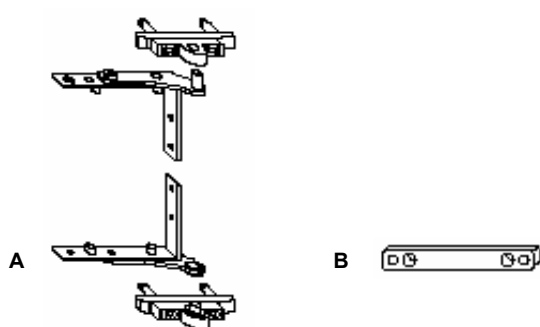
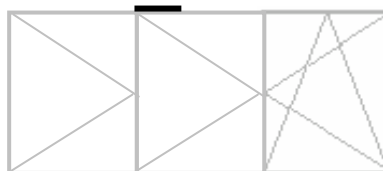

**Informatii tehnice**



	N ^o	Balama pentru fereastră cu 3 cercevele	Culoare	 Kg	
A	10721	dreapta sus+jos	argintiu	80Kg	20
	10722	stanga sus+jos	argintiu	80Kg	20
	11251	dreapta sus+jos	alb	80Kg	20
	11252	stanga sus+jos	alb	80Kg	20
B	43709	distantier 4mm	argintiu		100
	44199	distantier 4mm	alb		100
	354023	distantier 2mm	argintiu		100



	N ^o	Capac pentru Balama-fereastră cu 3 cercevele	
A	41117	alb	20
	41642	bronz stralucitor	20
	40737	auriu	50
	40734	titan	50
	41698	sampanie	50
	43618	argintiu	50
	44287	argintiu lacuit	20
	44294	crom	20
	42723	maro	20

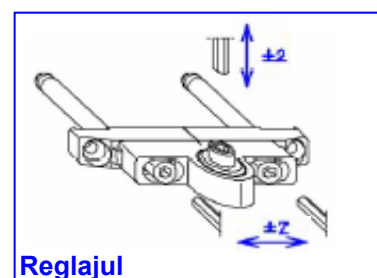

MACO MULTI TREND

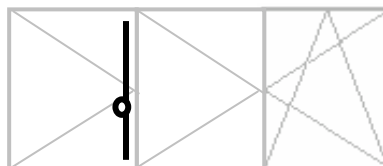

Informatii tehnice

Tija cremon B constanta, cu inversor - DM 6,5 mm

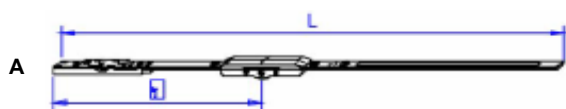

55892	3

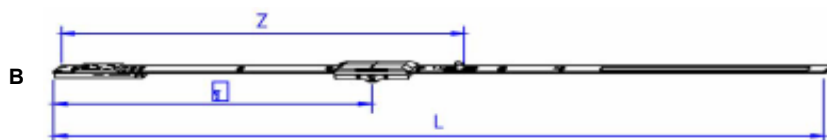

55893	5
55894	5
55895	7
55896	7

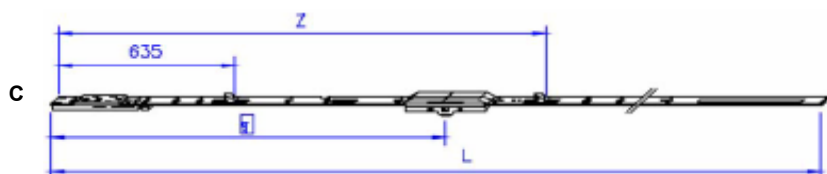

55897	9
55898	11

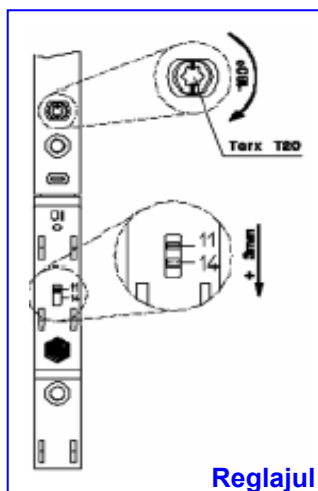

f	l	h	1	2	3	4	5	6	7	8	9	10	11	12	13	14	15
300	550-800	28	119,5	230	370												
400	800-1000	28	119,5	330	470	632,5											
500	1000-1300	28	119,5	290	430	570	803,5										
600	1250-1500	28	119,5	324,5	530	670	868,5	1077,5									
700	1500-1800	28	119,5	289,5	468,5	630	770	945,5	1120,5	1303,5							
1050	1800-2100	28	119,5	355,5	590	719	850	980	1120	1375,5	1605,5						
1050	2100-2300	28	119,5	355,5	590	719	850	980	1120	1344,5	1535,5	1726,5	1927,5				

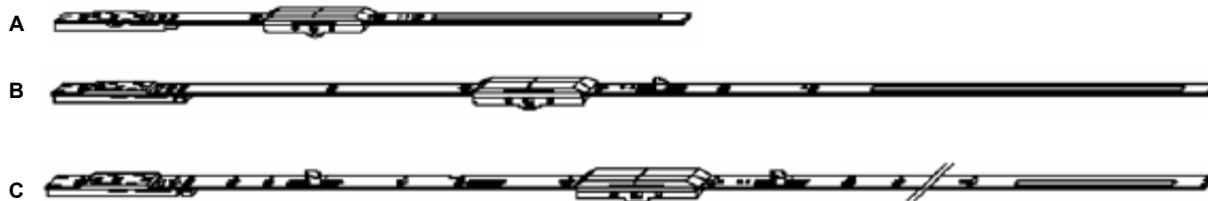
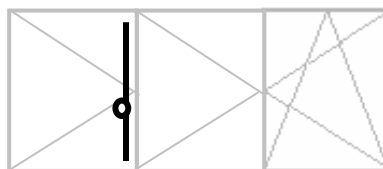

	Argintiu N ₀	Tija cremon B constanta, cu inversor	Z			L	
A	55892	DM 6,5	-	300	550 - 800	540	10
B	55893	DM 6,5	535	400	801 - 1000	715	10
	55894	DM 6,5	536	500	1001 - 1300	925	10
C	55895	DM 6,5	735	600	1250 - 1500	925	10
	55896	DM 6,5	835	700	1501 - 1800	1215	10
	55897	DM 6,5	635 / 1185	1050	1801 - 2100	1425	10
	55898	DM 6,5	635 / 1185	1050	2101 - 2350	1215	10

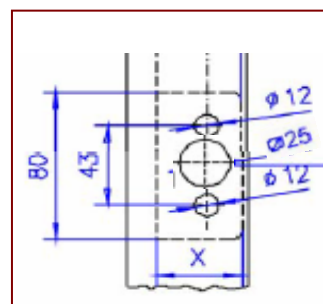
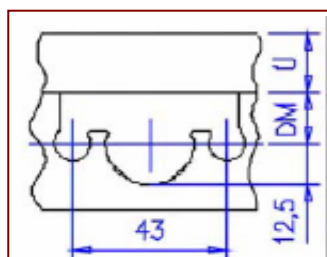
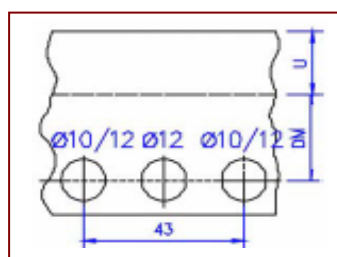

$$x = DM + 12,5 \text{ mm}$$

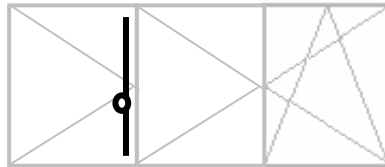

Informatii tehnice

Tija cremon B constanta, cu inversor - DM 15 mm



55144	2
55052	3

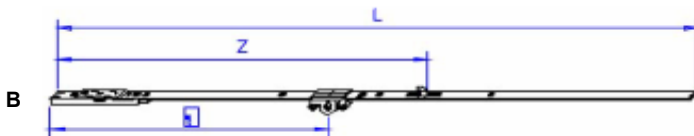

57853	5
55053	5
55908	6
57854	7
55054	6
57857	8
55055	7
55056	9

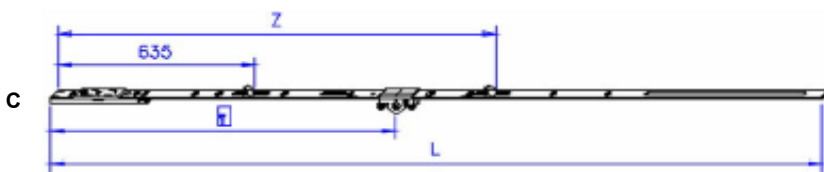

57855	8
57856	10
55858	9
57859	10
55257	9
55258	11

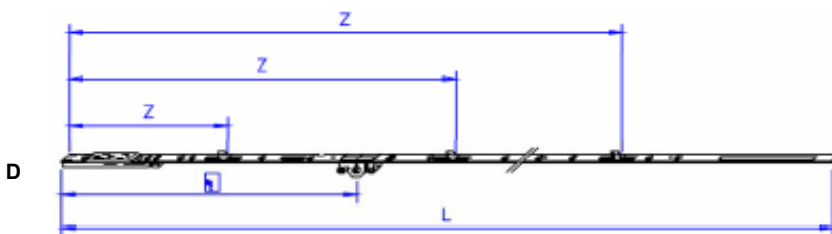

55259	12

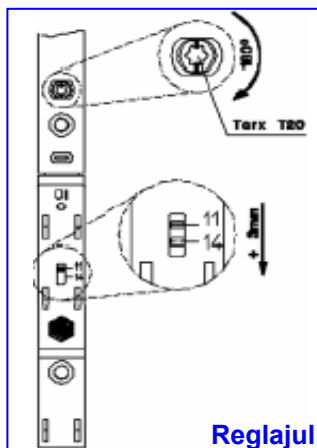

E	D	h	h1	h2	h3	h4	h5	h6	h7	h8	h9	h10	h11	h12
190	350-600	28	119,5											
300	500-800	28	119,5	230										
300	800-1100	28	119,5	230	370	503,5								
400	800-1000	28	119,5	330	470	632,5								
400	1000-1300	28	119,5	330	470	632,5	794,5							
400	1300-1500	28	119,5	330	470	694,5	916,5	1139,5						
400	1500-1800	28	119,5	330	470	694,5	916,5	1140	1294,5					
400	1800-2100	28	119,5	330	470	694,5	916,5	1140	1367,5	1594,5				
500	1000-1300	28	119,5	290	430	570	794,5							
500	1300-1500	28	119,5	290	430	570	759,5	949,5	1139,5					
500	1500-1800	28	119,5	290	430	570	759,5	949,5	1140	1294,5				
500	1800-2100	28	119,5	290	430	570	759,5	949,5	1140	1366,5	1594,5			
600	1250-1500	28	119,5	324,5	530	670	868,5	1077,5						
700	1500-1800	28	119,5	289,5	459,5	630	770	944,5	1119,5	1303,5				
1050	1800-2100	28	119,5	355,5	590	365,5	980	1153	1373,5	1603,5				
1050	2100-2300	28	119,5	355,5	590	365,5	980	1153	1344,5	1535,5	1726,5	1827,5		
1050	2300-2550	28	119,5	355,5	590	365,5	980	1153	1356,5	1561,5	1765,5	1970	2113,5	

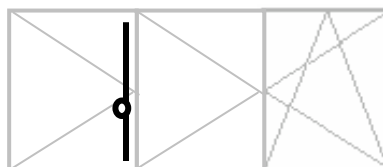

	Argintiu N	Tija cremon B constanta, cu inversor	Z			L	
A	55144	DM 15	-	190	351 - 600	540	10
	55052	DM 15	-	300	500 - 800	715	10
B	57853	DM 15	435	300	801 - 1000	925	10
C	55053	DM 15	535	400	801 - 1000	925	10
	55908	DM 15	535	400	1001 - 1300	1215	10
	57854	DM 15	535	400	1301 - 1500	1425	10
	55054	DM 15	635	500	1001 - 1300	1215	10
	57857	DM 15	635	500	1301 - 1500	1425	10
	55055	DM 15	735	600	1251 - 1500	1525	10
	55056	DM 15	835	700	1501 - 1800	1715	10
D	57855	DM 15	535 / 1185	400	1501 - 1800	1715	10
	57856	DM 15	535 / 1185	400	1801 - 2100	2015	10
	57858	DM 15	635 / 1185	500	1501 - 1800	1715	10
	57859	DM 15	635 / 1185	500	1801 - 2100	2015	10
	55257	DM 15	635 / 1370	1050	1801 - 2100	2015	10
D	55258	DM 15	635 / 1370	1050	2101 - 2350	2275	10
	55259	DM 15	635 / 1370 / 1925	1050	2301 - 2550	2525	10

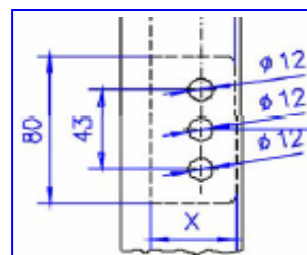
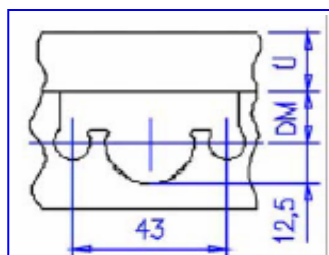
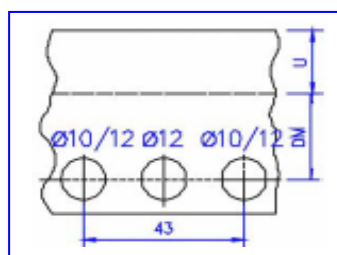

$$x = DM + 12,5 \text{ mm}$$

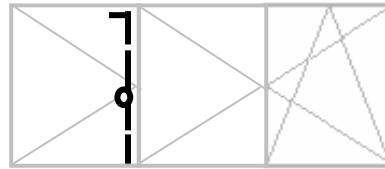



Informatii tehnice

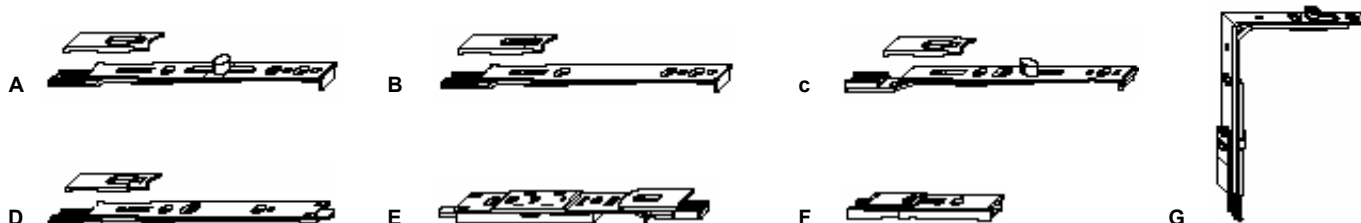
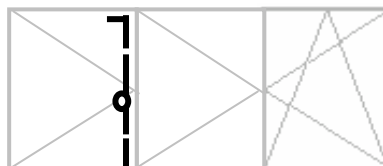

Inchizator final pentru tija OB

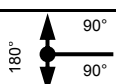
<p>A</p>	 <hr/> 52496 3	<p>B</p>	 <hr/> 202747 3
<p>C</p>	 <hr/> 10538 3	<p>D</p>	 <hr/> 10795 3
<p>E</p>		 <hr/> 52841 2	
<p>G</p>	<div style="border: 1px solid blue; padding: 2px; display: inline-block;"> axa x : 114 mm axa y : 114 mm ; 147 mm </div>	 <hr/> 10834 3	



	Argintiu N III	Inchizator final pentru tija OB			
A	52496	Inchizator final cu rola de inchidere	miscare 180°	370 - 2350	20
B	202747	Inchizator final fara rola de inchidere	miscare 180°	370 - 2350	20
C	10538	Inchizator final cu rola de inchidere	miscare 90°	370 - 2350	20
D	10795	Inchizator final cu tija de inchidere	miscare 90°	370 - 2350	20
E	52841	Zavor inferior cu inversor	miscare 90°	500 - 2350	20
F	10837	Zavor superior pt. tija cremon B cu inversor	miscare 90°	500 - 2350	20
G	10834	Inchizator final superior	miscare 90°	370 - 2350	50

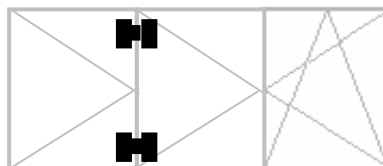
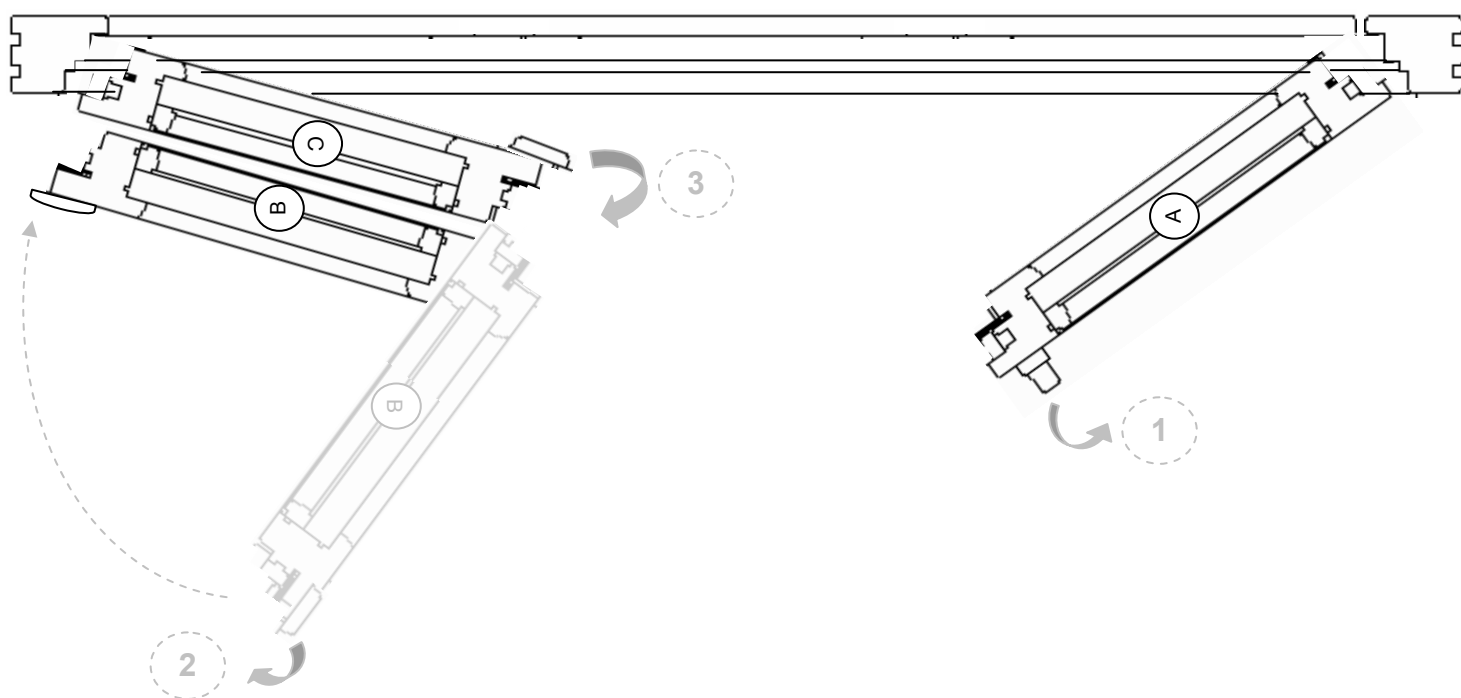
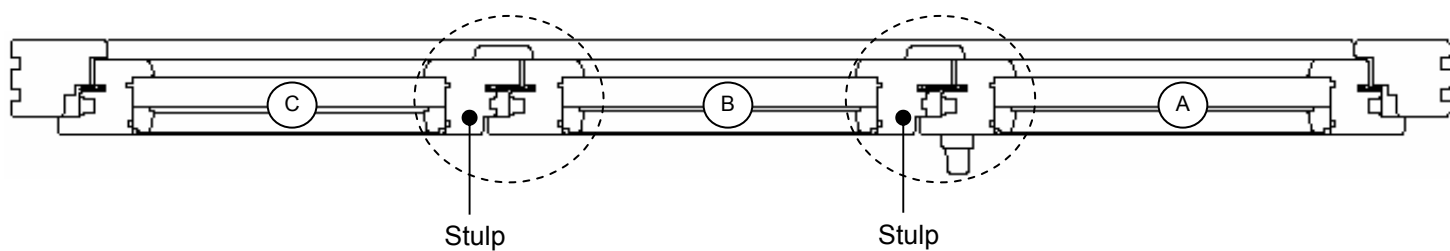

	Argintiu N III	Piese de inchidere pentru ferestre cu 3 cercevele	
A	55039	piesa de inchidere tip mama pt. ferestre cu 3 cercevele	100
B	94038	piesa de inchidere - opusa nutului de feronerie	100

**Fereastra cu trei canaturi fara montant**

- Cerceveaua "A" se poate deschide independent fata de celelalte doua cercevele, pe pozitiile: "Batant" sau "Oscilo-Batant".
- Cerceveaua "B" se poate deschide pe pozitia "Batant" numai atunci cand cerceveaua "A" se afla deschisa pe pozitia "Batant".
- Cerceveaua "C" se poate deschide pe pozitia "Batant" numai atunci cand cerceveaua "B" se afla pozitionata paralel cu aceasta.

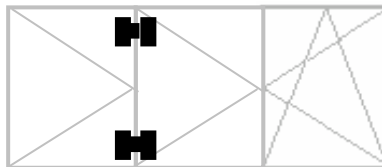

Balama pentru cercevea centrala

Piesa pt. inchidere zavor



Balama lagar + Distantiar + Stift



Capac pt. Balama lagar



Capac pt. Balama lagar



Balama lagar + Distantiar + Stift



Zavor superior pt. tija inchidere stulp



Tija inchidere stulp cu miscarea parghiei 180°



Piesa pt. inchidere zavor

Semibalama + Distantier

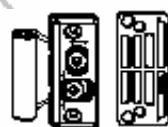

Capac pentru balama cercevea sus si semibalama

Capac pentru balama cercevea sus si semibalama



Semibalama + Distantier

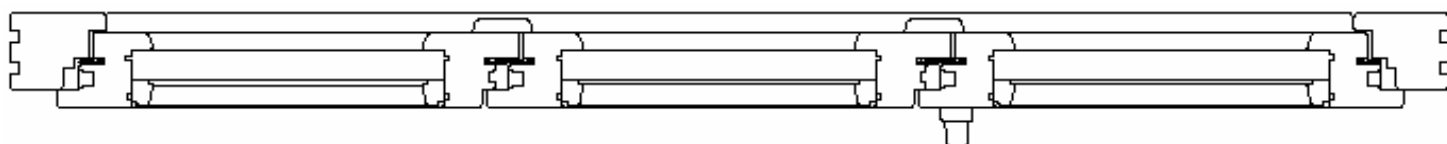
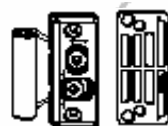

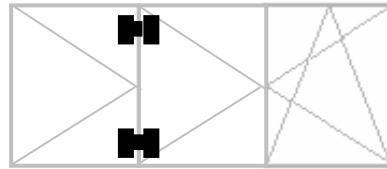
MACO MULTI TRENDInformatii tehnice

Balama lagar pentru a 3-a cercevea + semibalama

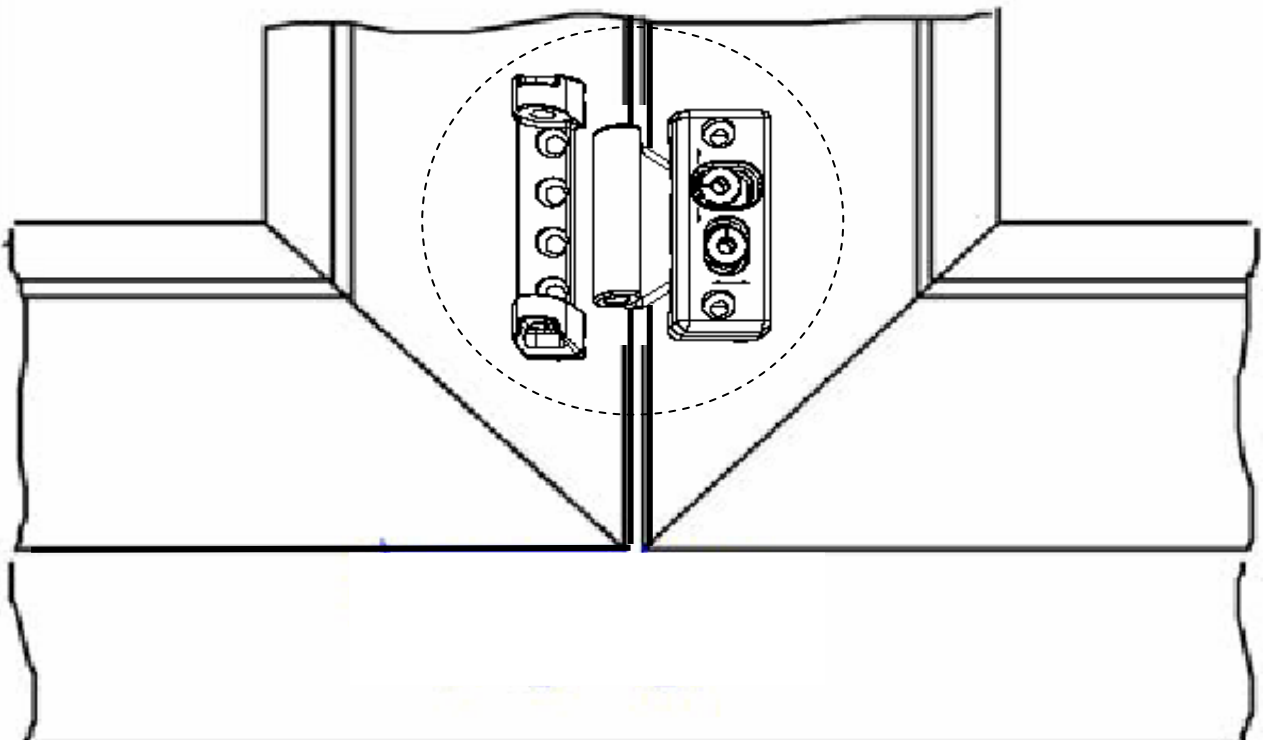
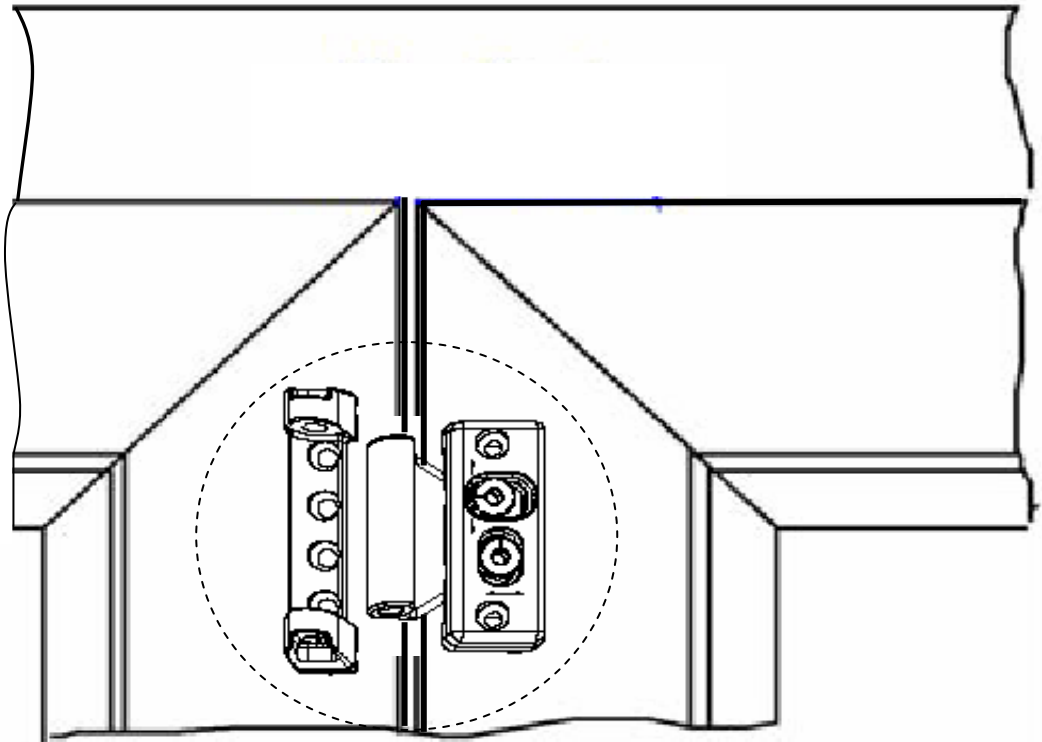
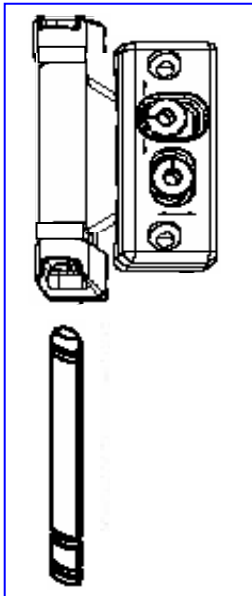

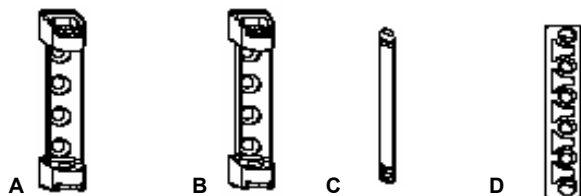
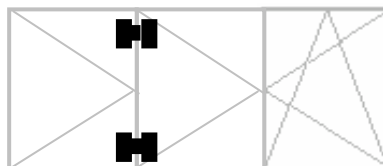

	N ^o	Balama lagar pentru a 3-a cercevea	Culoare		
A	57930	cu bolturi de pozitionare >0< 3mm	argintiu	80	100
B	202848	cu bolturi de pozitionare >0< 7mm	argintiu	100	50
	205705	cu bolturi de pozitionare >0< 7mm	alb	100	50
C	52480	cu bolturi de pozitionare >0< 3mm	argintiu	80	100
	21953	cu bolturi de pozitionare >0< 3mm	alb	80	100
D	94491	stift	argintiu		200
	44474	distantier pentru bolturi de 7 mm	maro		100
	44475	distantier pentru bolturi de 7 mm	argintiu		100
	44470	distantier pentru bolturi de 7 mm	alb		100
	44481	distantier pentru bolturi de 3 mm	maro		100
	44482	distantier pentru bolturi de 3 mm	argintiu		100
	44477	distantier pentru bolturi de 3 mm	alb		100

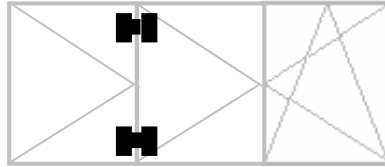

	N ^o	Capac pentru balama lagar	Culoare	
A	42083	capac balama toc sus	alb	100
	42097	capac balama toc sus	bronz	100
	42098	capac balama toc sus	auriu	100
	42099	capac balama toc sus	titan	100
	42103	capac balama toc sus	sampanie	100
	43761	capac balama toc sus	argintiu	100
	42191	capac balama toc sus	crem	100
	42189	capac balama toc sus	maro	100
	44243	capac balama toc sus	crom	100
	42190	capac balama toc sus	negru	100

Informatii tehnice

Balama lagar pentru a 3-a cercevea + semibalama

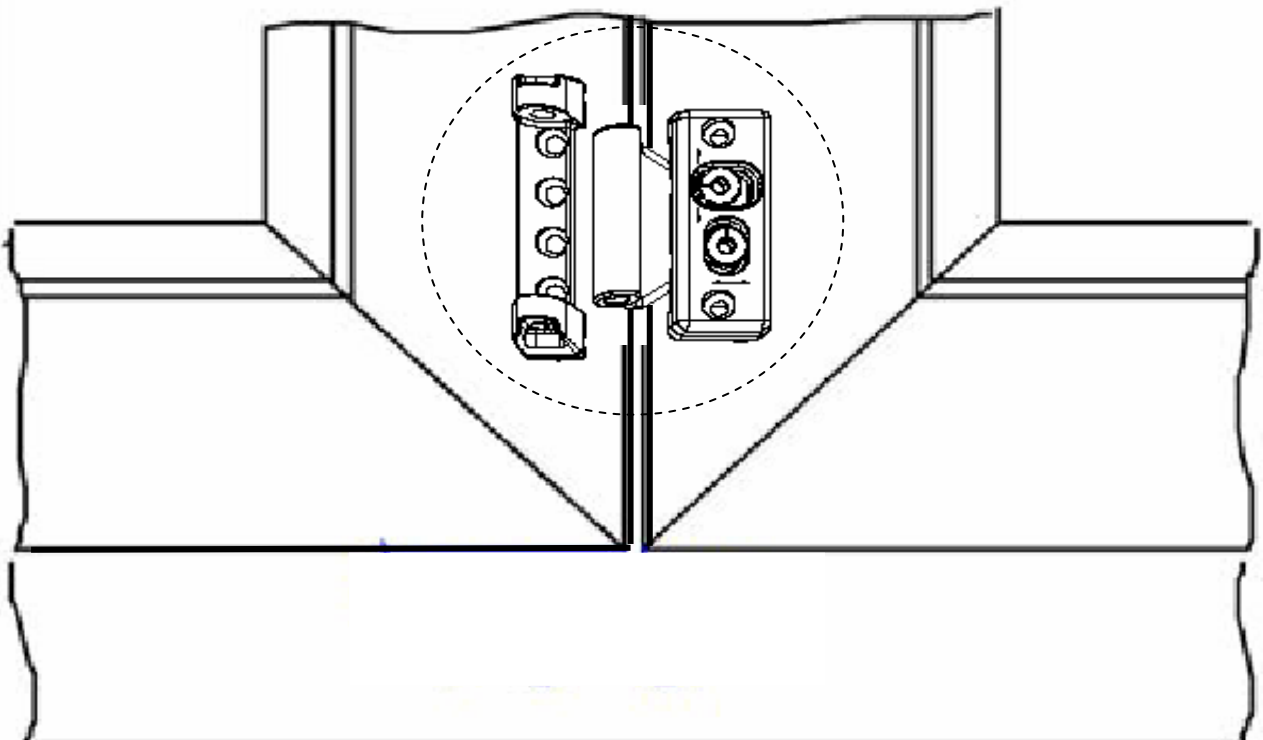
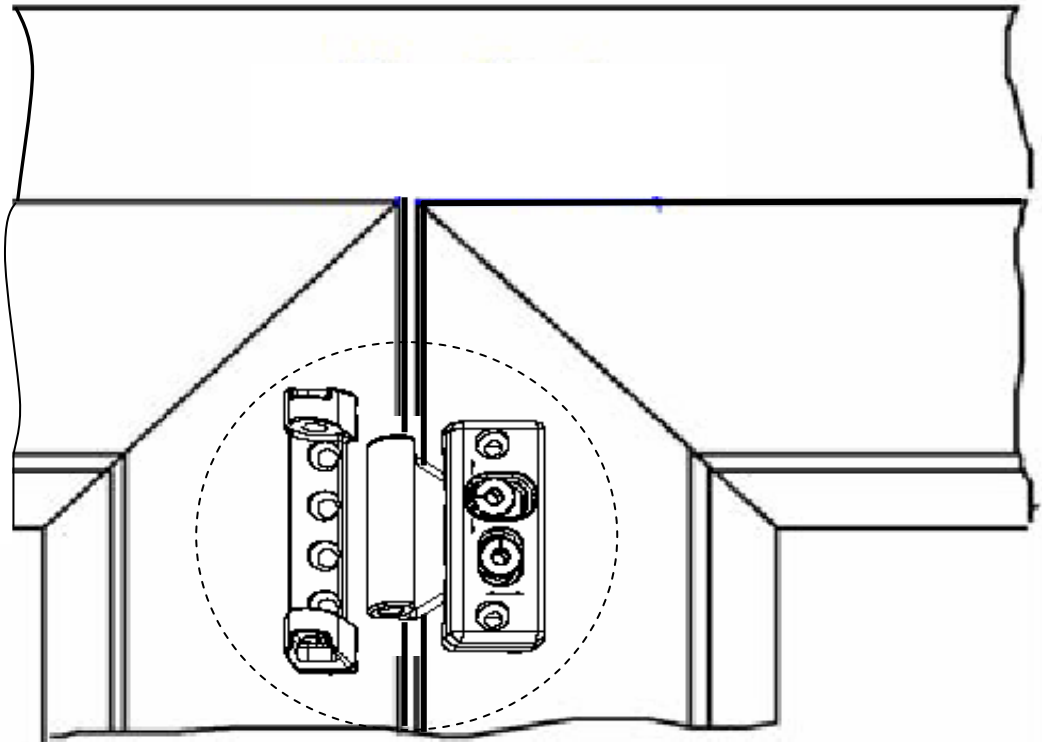
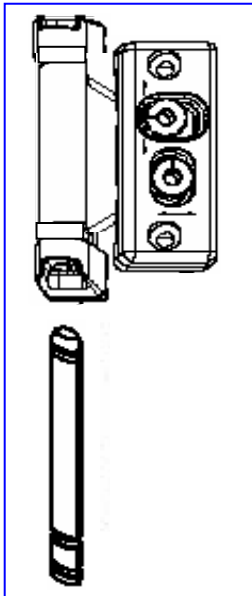

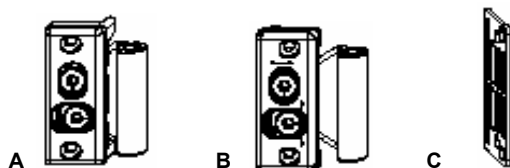
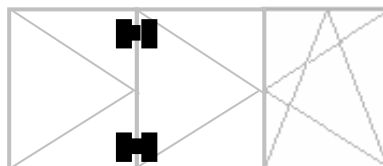



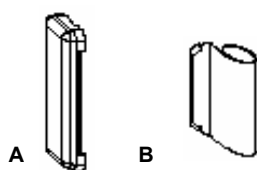

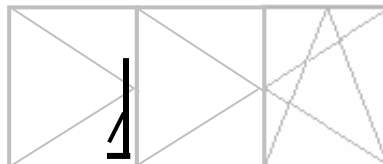
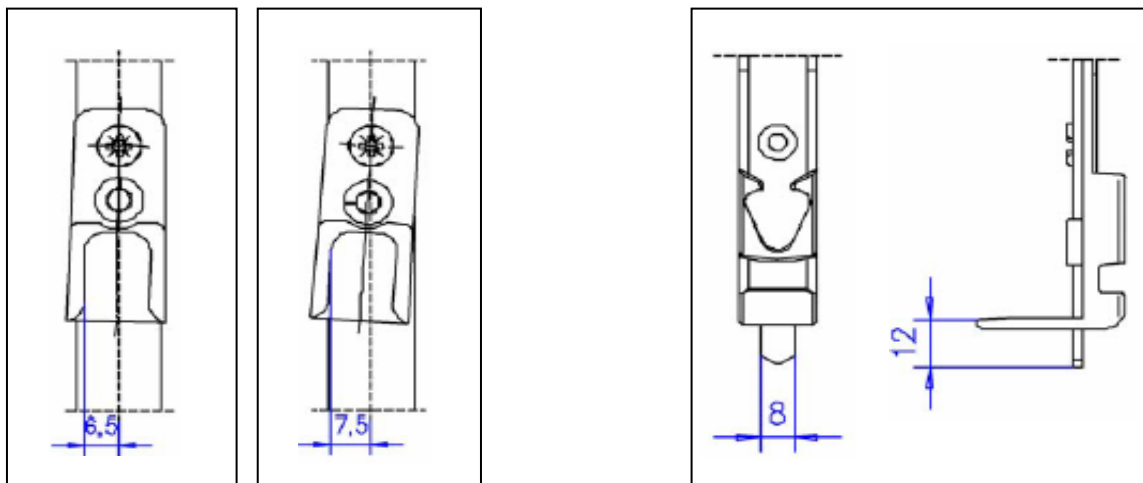
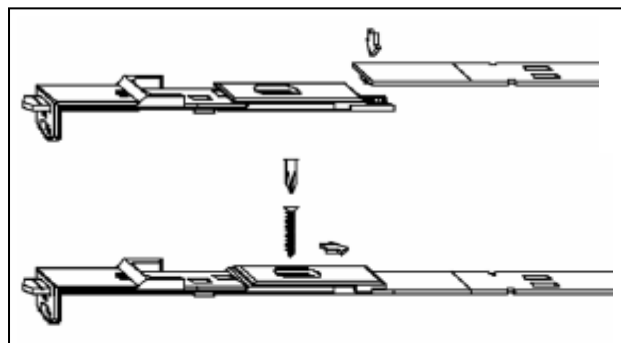
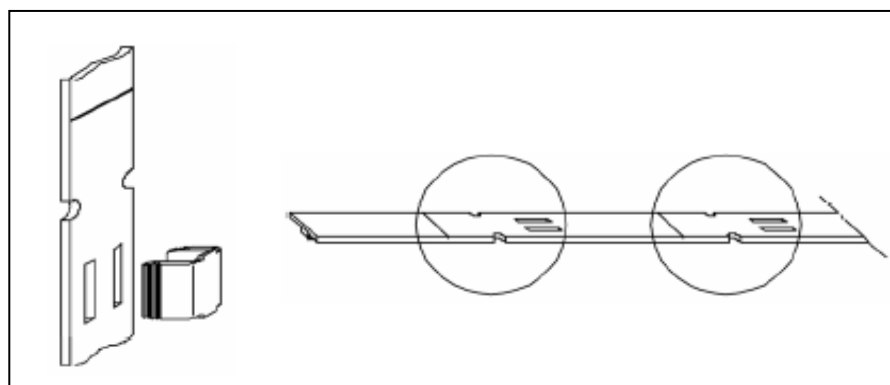

	N ^o	Semibalama	Culoare		
A	57892	pt. Lemn	argintiu	60	50
B	220240	cu bolturi de pozitionare >0< 7mm	argintiu	60	50
	204249	cu bolturi de pozitionare >0< 7mm	argintiu	60	50
	220241	cu bolturi de pozitionare >0< 3mm	argintiu	60	50
C	44460	distantier pentru bolturi de 7 mm	maro		100
	44461	distantier pentru bolturi de 7 mm	argintiu		100
	44456	distantier pentru bolturi de 7 mm	alb		100
	44467	distantier pentru bolturi de 3 mm	maro		100
	44468	distantier pentru bolturi de 3 mm	argintiu		100
	44463	distantier pentru bolturi de 3 mm	alb		100

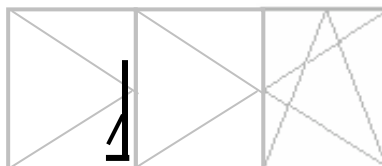

	N ^o	Capac pentru balama lagar	Culoare	
A	43800	capac semibalama	alb	100
	43801	capac semibalama	bronz	100
	43802	capac semibalama	auriu	100
	43803	capac semibalama	titan	100
	44288	capac semibalama	sampanie	100
	44102	capac semibalama	argintiu	100
	44295	capac semibalama	crem	100
	43804	capac semibalama	maro	100
	44286	capac semibalama	crom	100
	354350	capac semibalama	negru	100
B	42084	capac balama cercevea sus	alb	100
	42105	capac balama cercevea sus	bronz	100
	42106	capac balama cercevea sus	auriu	100
	42107	capac balama cercevea sus	titan	100
	42108	capac balama cercevea sus	sampanie	100
	43760	capac balama cercevea sus	argintiu	100
	42194	capac balama cercevea sus	crem	100
	42192	capac balama cercevea sus	maro	100
44244	capac balama cercevea sus	crom	100	
42193	capac balama cercevea sus	negru	100	

**Informatii tehnice****A Tija inchidere stulp constanta "Euronut" cu miscarea pirghierii 180°***dimensiunile tije de inchidere***B Zavor superior pt. tija stulp "Euronut"***cuplarea cu zavorul superior**centrarea cremalierii*



	Argintiu N 	Tija inchidere stulp "Euronut" cu miscarea pirghieri 180°	L			
A	55976	Gr. 2 dreapta	910	400	801 - 1000	10
	55972	Gr. 2 stanga	910	400	801 - 1000	10
	55977	Gr. 3 dreapta	1110	500	1001 - 1250	10
	55973	Gr. 3 stanga	1110	500	1001 - 1250	10
	55978	Gr. 4 dreapta	1360	600	1251 - 1500	10
	55974	Gr. 4 stanga	1360	600	1251 - 1500	10
	55979	Gr. 5 dreapta	1610	700	1501 - 1750	10
	55975	Gr. 5 stanga	1610	700	1501 - 1750	10
	55982	Gr. 6 dreapta	1960	1050	1851 - 2100	10
	55980	Gr. 6 stanga	1960	1050	1851 - 2100	10
	55983	Gr. 7 dreapta	2210	1050	2101 - 2350	10
	55981	Gr. 7 stanga	2210	1050	2101 - 2350	10
	B	52839	zavor superior pt. tija stulp "Euronut"		-	550-2350

Gr.	Gr.2	Gr.3	Gr.4	Gr.5	Gr.6	Gr.7
	5	7	8	10	11	13

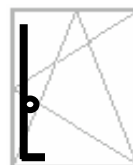

Informatii tehnice

Tija cremon OB constanta, DM 6,5 mm

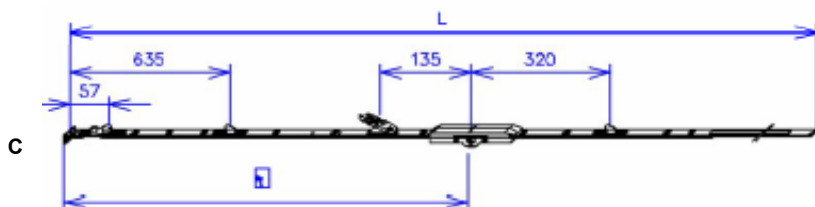
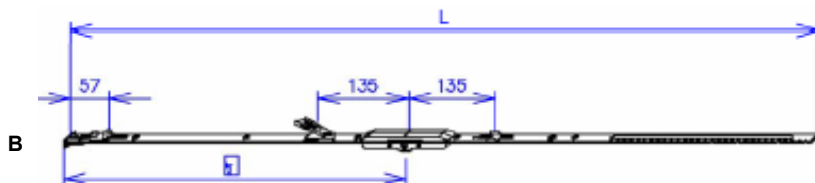
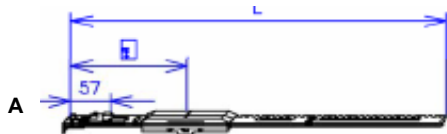

Gr.0	2
Gr.1	4

Gr.1B	4
Gr.2	4
Gr.3	6
Gr.4	7
Gr.5	9

Gr.6	11
Gr.6A	9

Tija cremon OB variabila, DM 6,5 mm

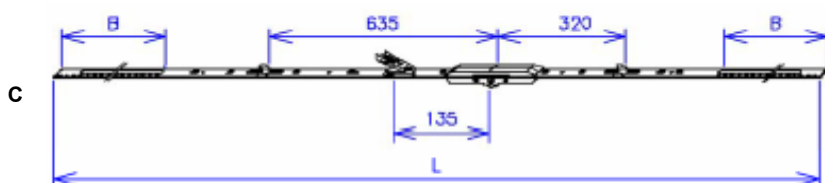
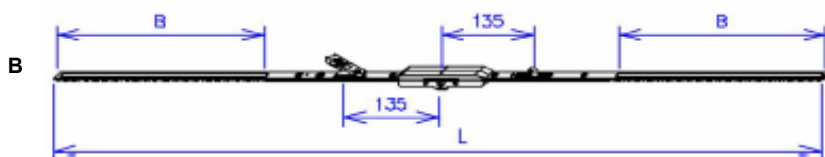
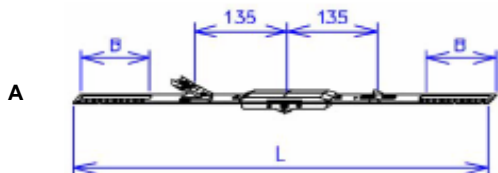

Gr.2	2



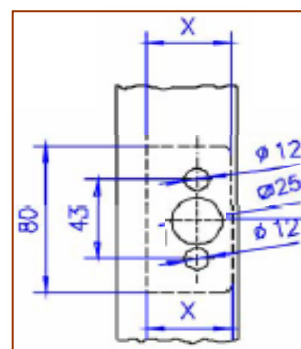
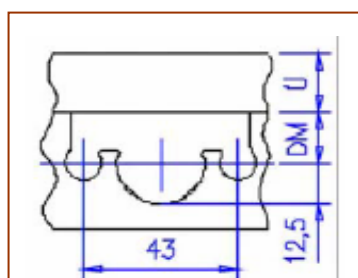
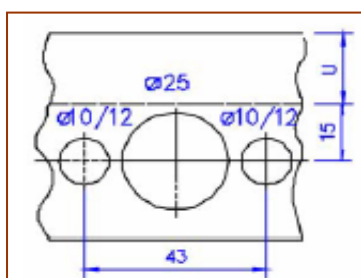

Gr.2A	4
Gr.3	4
Gr.4	6

Gr.5	9

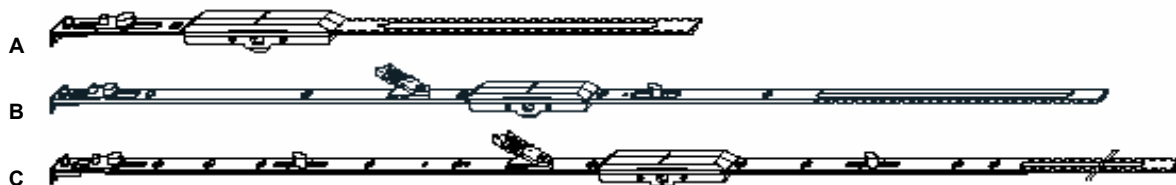
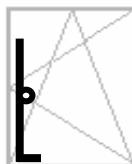





$x = DM + 12,5 \text{ mm}$

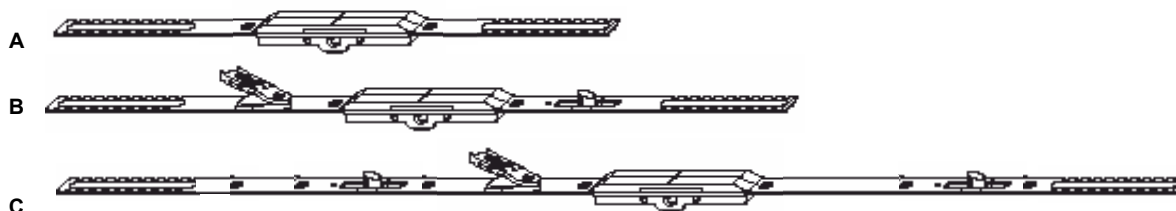

	Argintiu N 	Tija cremon OB constanta, DM 6,5 mm			L	
A	52415	Gr. 0	170	450 - 600	540	20
	52416	Gr. 1	300	601 - 800	720	20
B	55062	Gr. 1B cu siguranta	300	601 - 800	720	20
	52417	Gr. 2	400	801 - 1000	910	20
	52418	Gr. 3	500	1001 - 1250	1110	20
	52419	Gr. 4	600	1251 - 1500	1360	10
	52420	Gr. 5	700	1501 - 1750	1610	10
C	52421	Gr. 6	1050	1851 - 2100	1960	10
	203265	Gr. 6A	1050	1651 - 1850	1680	10



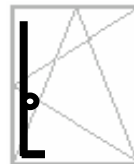

	Argintiu N 	Tija cremon OB, variabila , DM 6,5 mm	B		L	
A	54564	Gr. 2 .B & OB	160	600 - 900	600	10
B	52428	Gr. 2A cu siguranta	72	750 - 900	600	10
	52429	Gr. 3	290	901 - 1300	1125	10
	52430	Gr. 4	290	1301 - 1800	1525	10
C	52431	Gr. 5	290	1801 - 2200	1940	10

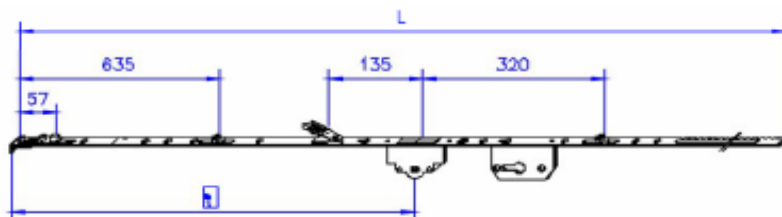

Informatii tehnice

Tija cremon OB constanta cu blocare din cilindru
DM 25 ; DM 30 ; DM 35 ; DM 40 ; DM 45 ; DM 50



	
Gr.6A	11
Gr.6	12
Gr.7	12



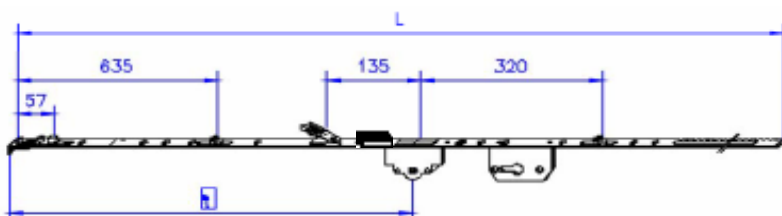

Tija cremon OB constanta cu blocare din cilindru - snapper premontat
DM 40 ; DM 45 ; DM 50

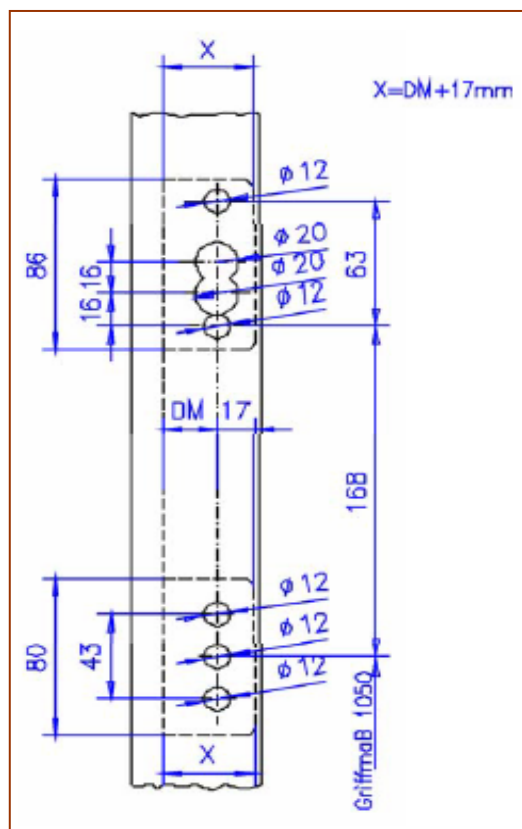
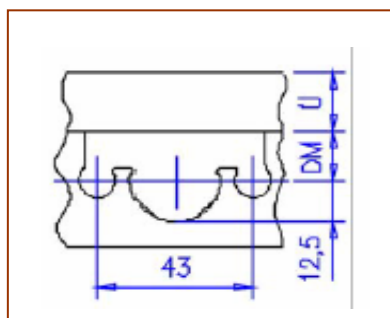
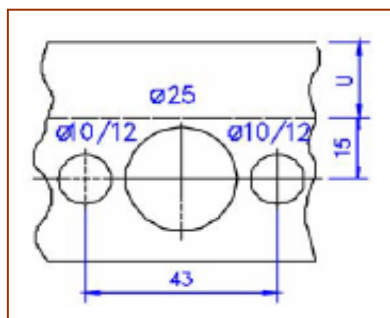

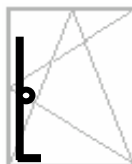



	
Gr.6A	11
Gr.6	12
Gr.7	12









	Argintiu N ^o	Tija cremon OB, constanta , cu blocare din cilindru			L	
A	55096	Gr. 6 A DM 25 mm	1050	1651 - 1900	1680	10
	58443	Gr. 6 DM 25 mm	1050	1851 - 2100	1960	10
	52825	Gr. 7 DM 25 mm	1050	2101 - 2350	2210	10
	59942	Gr. 6 A DM 30 mm	1050	1651 - 1900	1680	10
	58442	Gr. 6 DM 30 mm	1050	1851 - 2100	1960	10
	54794	Gr. 7 DM 30 mm	1050	2101 - 2350	2210	10
	54566	Gr. 6 DM 35 mm	1050	1851 - 2100	1960	10
	54569	Gr. 7 DM 35 mm	1050	2101 - 2350	2210	10
	52830	Gr. 6 DM 40 mm	1050	1851 - 2100	1960	10
	52831	Gr. 7 DM 40 mm	1050	2101 - 2350	2210	10
	54568	Gr. 6 DM 45 mm	1050	1851 - 2100	1960	10
	54571	Gr. 7 DM 45 mm	1050	2101 - 2350	2210	10
	54741	Gr. 6 DM 50 mm	1050	1851 - 2100	1960	10
	55188	Gr. 7 DM 50 mm	1050	2101 - 2350	2210	10

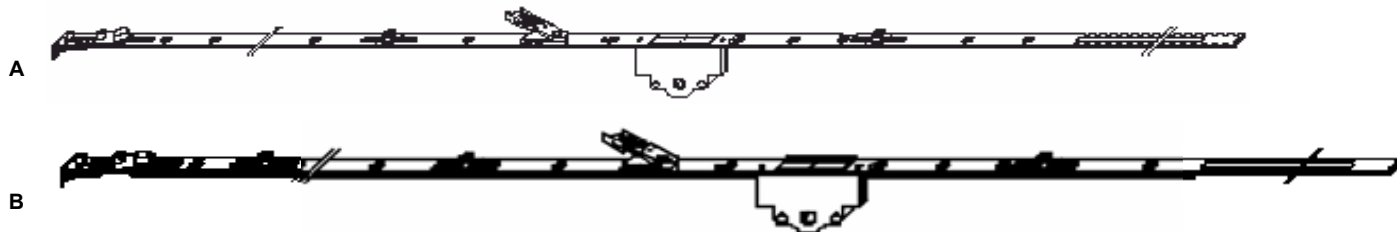
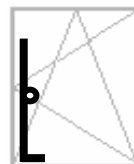

	Argintiu N ^o	Tija cremon OB constanta , cu blocare din cilindru+schnapper			L	
A	55082	Gr. 6 DM 40 mm cu schnapper	1050	1851 - 2100	1960	10
	55083	Gr. 7 DM 40 mm cu schnapper	1050	2101 - 2350	2210	10
	57835	Gr. 6 DM 45 mm cu schnapper	1050	1851 - 2100	1960	10
	57836	Gr. 7 DM 45 mm cu schnapper	1050	2101 - 2350	2210	10
	58133	Gr. 6 DM 50 mm cu schnapper	1050	1851 - 2100	1960	10
	58134	Gr. 7 DM 50 mm cu schnapper	1050	2101 - 2350	2210	10



	Argintiu N ₀	Tija cremon OB constanta			L	
A	55036	Gr. 6 A DM 25 mm	1050	1661 - 1850	1680	10
	55034	Gr. 6 DM 25 mm	1050	1851 - 2100	1960	10
	220020	Gr. 6 A DM 30 mm	1050	1661 - 1850	1680	10
	220019	Gr. 6 DM 30 mm	1050	1851 - 2100	1960	10
	220472	Gr. 7 DM 30 mm	1050	2101 - 2350	1960	10
	57231	Gr. 6 A DM 35 mm	1050	1661 - 1850	1680	10
	220471	Gr. 6 DM 35 mm	1050	1851 - 2100	1960	10
	220473	Gr. 7 DM 35 mm	1050	2101 - 2350	1960	10
B	59907	Gr. 6 DM 45 mm cu 3 role is	1050	1851 - 2100	1960	10

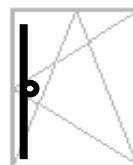

Informatii tehnice

Tija cremon OB variabila
DM 25 ; DM 30 ; DM 35 ; DM 40

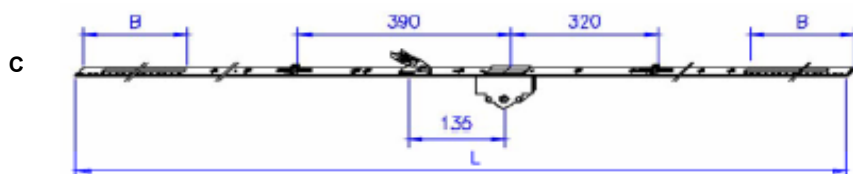
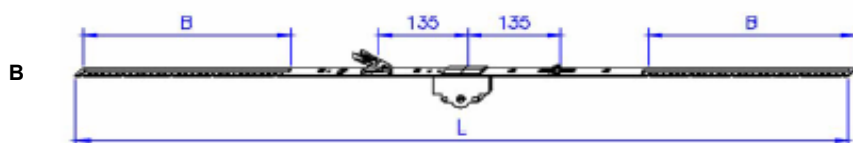
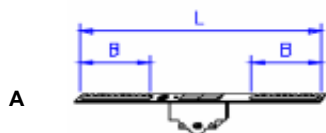



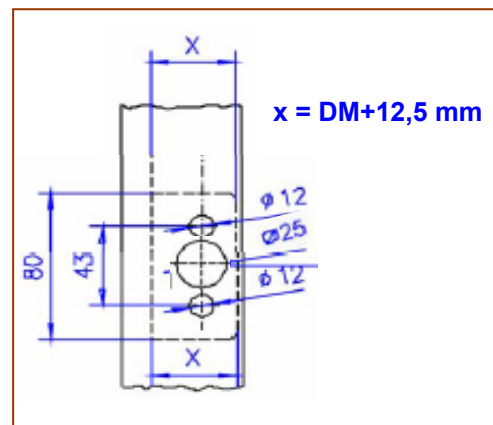
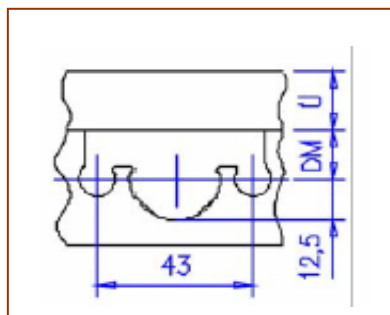
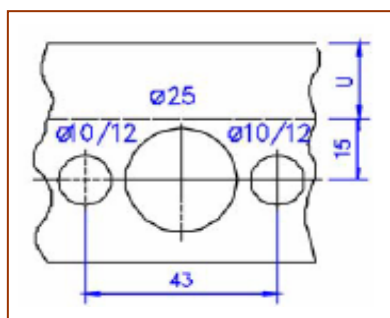

Gr.1	0
Gr.2	2

Gr.2A	2
Gr.3	4
Gr.4	6

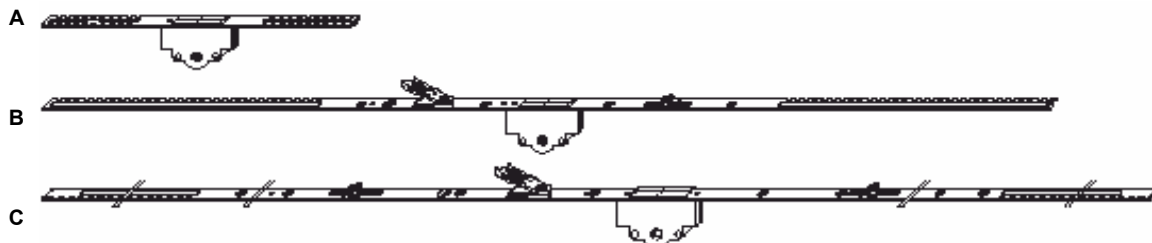
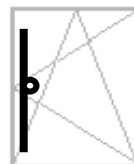

Gr.5	8



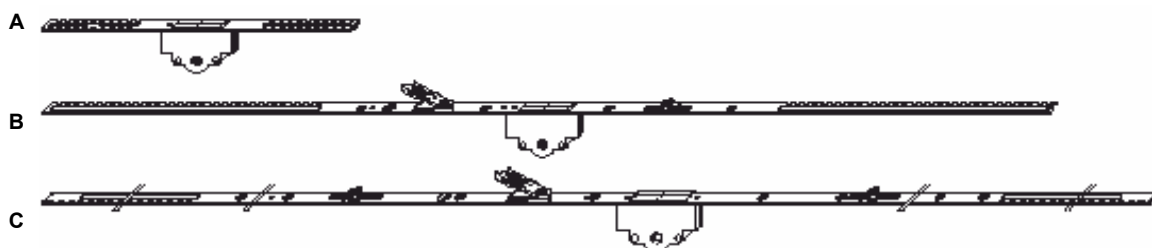

	Argintiu N ^o	Tija cremon OB, variabila , DM 25 mm si DM 30 mm	L		B	
A	55182	Gr. 1 DM 25 mm	350	500 - 650	92	10
	54773	Gr. 2 DM 25 mm	600	651 - 900	160	10
B	55406	Gr. 2A DM 25 mm cu siguranta	600	750 - 900	72	10
	54790	Gr. 3 DM 25 mm	1125	901 - 1300	290	10
	54791	Gr. 4 DM 25 mm	1525	1301 - 1800	290	10
C	59927	Gr. 5 DM 25 mm	2010	1801 - 2350	290	10
A	55911	Gr. 1 DM 30 mm	350	500 - 650	92	10
	55318	Gr. 2 DM 30 mm	600	651 - 900	160	10
B	58007	Gr. 2A DM 30 mm cu siguranta	600	750 - 900	72	10
	58444	Gr. 3 DM 30 mm	1125	901 - 1300	290	10
	58009	Gr. 4 DM 30 mm	1525	1301 - 1800	290	10
C	58445	Gr. 5 DM 30 mm	2010	1801 - 2350	290	10



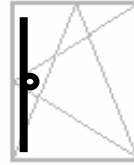

	Argintiu N ^o	Tija cremon OB, variabila , DM 35 mm si DM 40 mm	L		B	
A	55242	Gr. 1 DM 35 mm	350	500 - 650	92	10
	55244	Gr. 2 DM 35 mm	600	651 - 900	160	10
B	55254	Gr. 3 DM 35 mm	1125	901 - 1300	290	10
	55255	Gr. 4 DM 35 mm	1525	1301 - 1800	290	10
C	54782	Gr. 5 DM 35 mm	2010	1801 - 2350	290	10
A	55243	Gr. 1 DM 40 mm	350	500 - 650	92	10
	55245	Gr. 2 DM 40 mm	600	651 - 900	160	10
B	55185	Gr. 3 DM 40 mm	1125	901 - 1300	290	10
	55186	Gr. 4 DM 40 mm	1525	1301 - 1800	290	10
C	55187	Gr. 5 DM 40 mm	2010	1801 - 2350	290	10



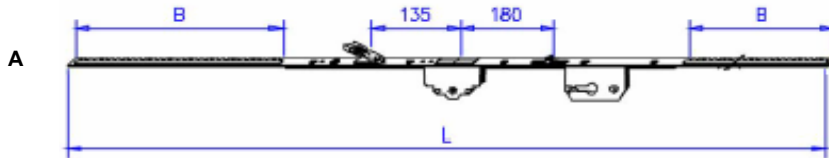

Informatii tehnice

Tija cremon OB variabila
DM 25 ; DM 30 ; DM 35 ; DM 40



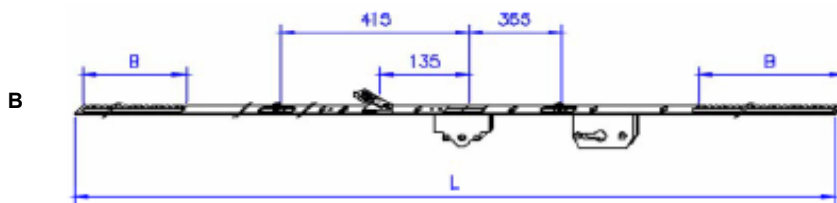



	
Gr.4	6

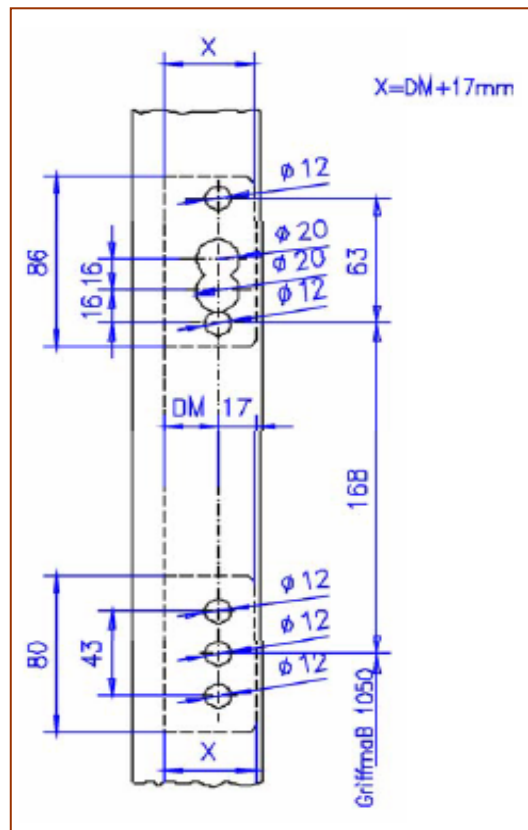
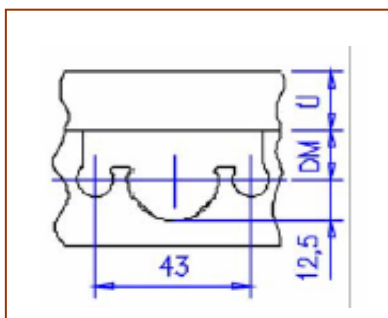
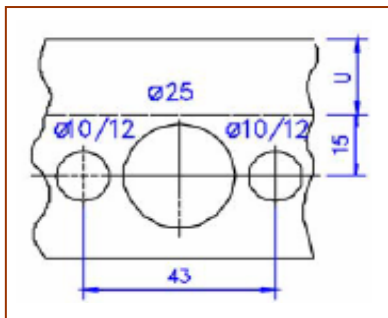

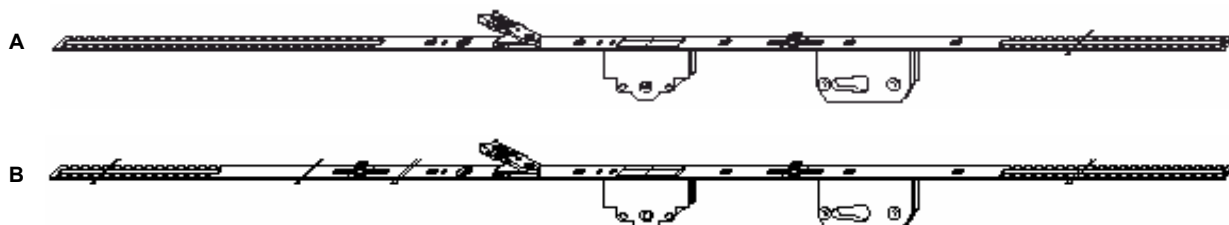
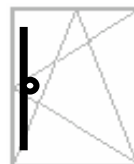
	
Gr.5	8





	Argintiu N ₁₀	Tija cremon OB, variabila , cu blocare din cilindru	L		B	
A	55945	Gr. 4 DM 25 mm	1525	1301 - 1800	300	10
A	55946	Gr. 4 DM 30 mm	1525	1301 - 1800	300	10
B	59494	Gr. 5 DM 30 mm	2010	1801 - 2350	300	10
A	201187	Gr. 4 DM 35 mm	1525	1301 - 1800	300	10
B	202722	Gr. 5 DM 35 mm	2010	1801 - 2350	300	10
A	55899	Gr. 4 DM 40 mm	1525	1301 - 1800	300	10





Deschidere Oscilo - Batanta

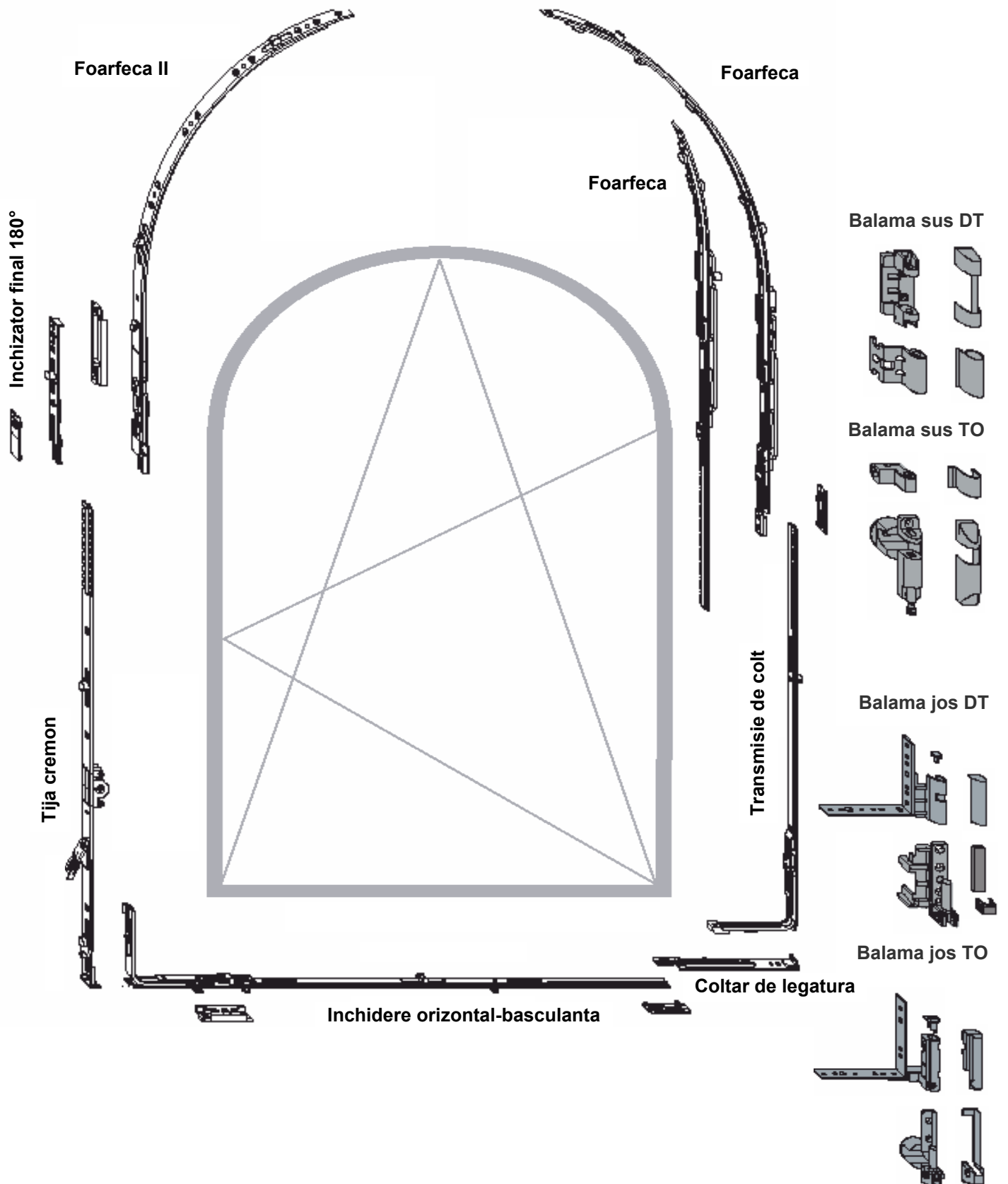



Informatii tehnice

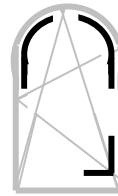

Foarfece DT

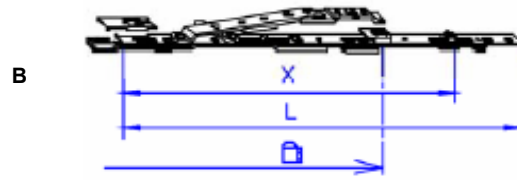
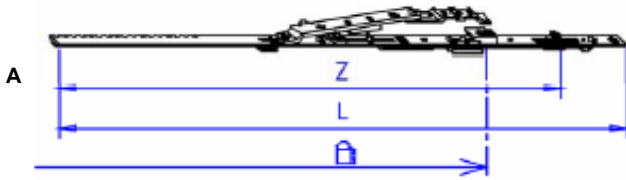

Gr.0	7
Gr.1	8

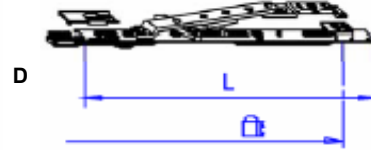
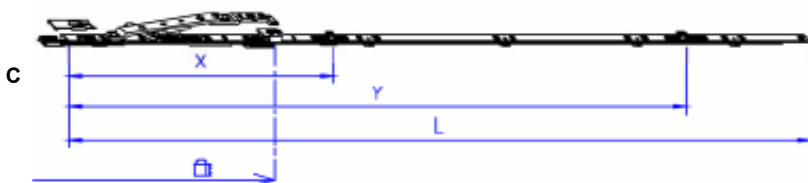

Gr.2	15
D	4

DT 18Ü/4L:

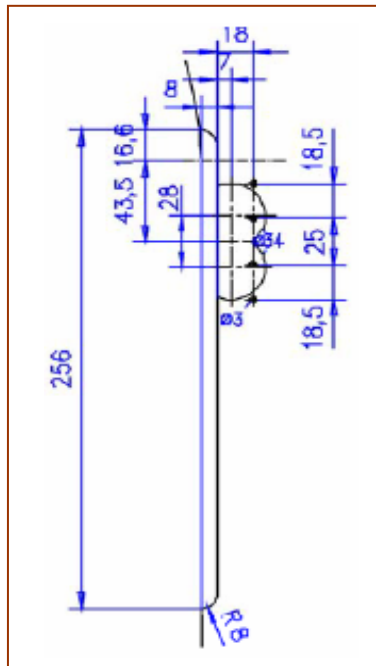

DT 20Ü/4L:

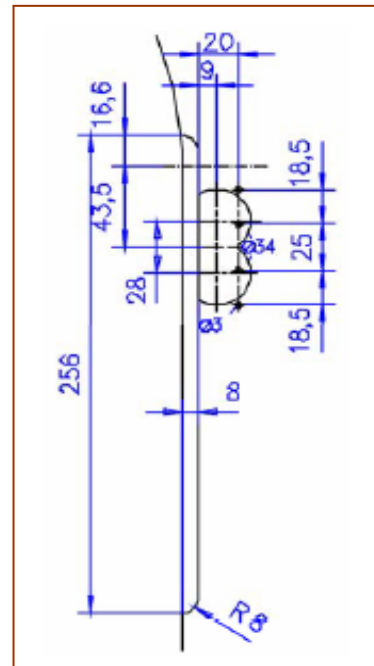



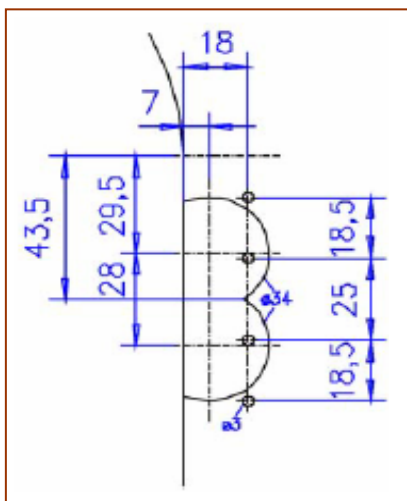

DT 18Ü/12L:

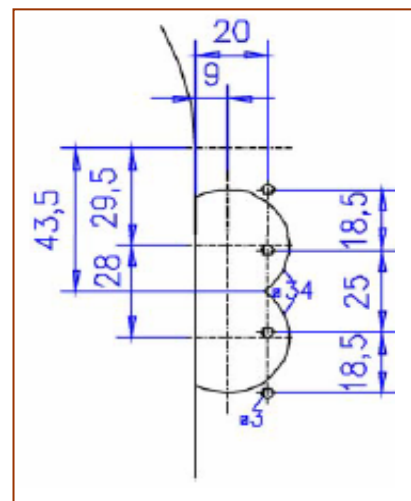

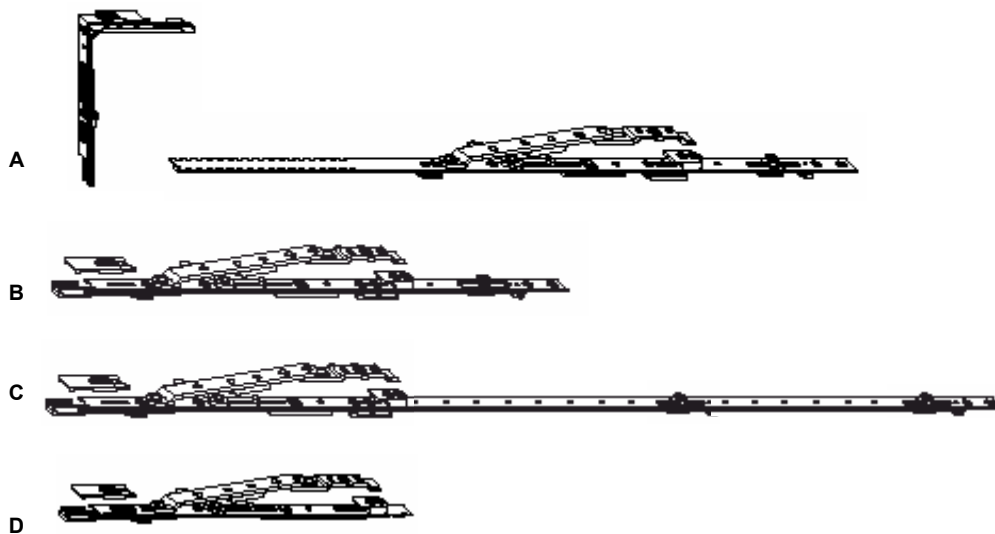
DT 20Ü/12L:





	Argintiu N ₁₀	Foarfecca DT	Z	L			
A	10525	Gr. 0 cu coltar de legatura Tip B	582	659	390 - 500	370 - 620	10
B	10976	Gr. 1 i.S	384	461	-	370 - 620	10
C	10724	Gr. 2 i.S	384/894	1075	-	621 - 1250	10
D	58183	cu posibilitate de cuplare in partea superioara		340	-	370 - 1250	10

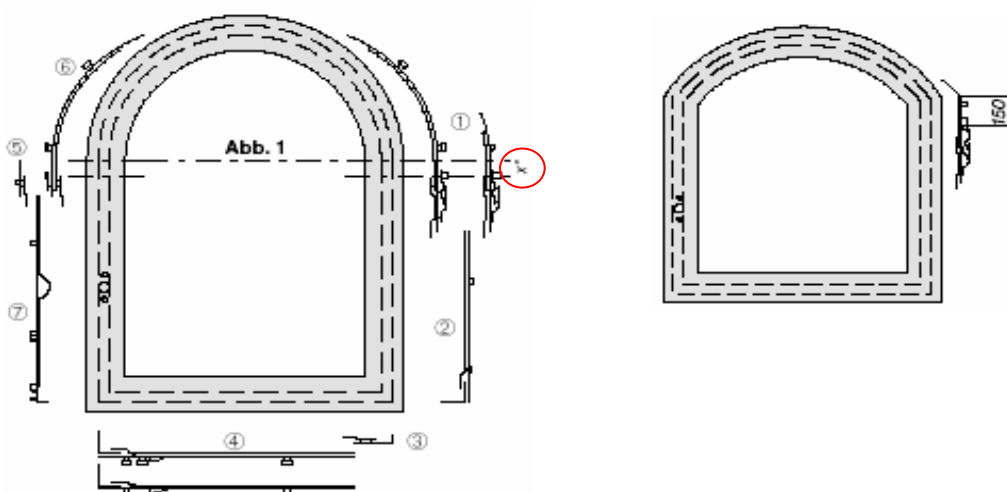

	x
TO	25 mm
DT	44 mm



Informatii tehnice

Foarfece TO

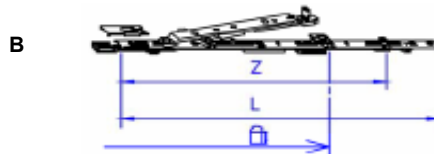
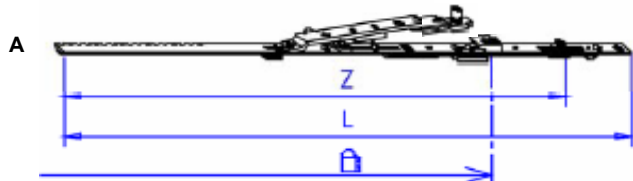

Gr.0	7
Gr.1	8

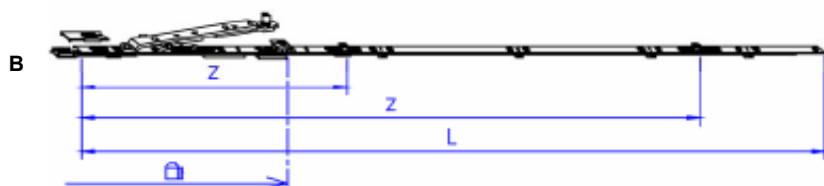

Gr.2	15

Foarfece II

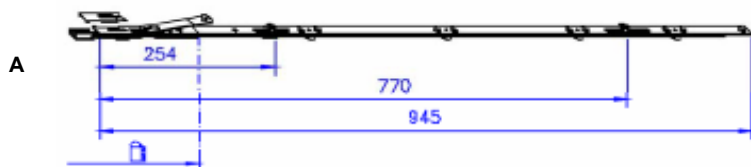

A	11

TO 15Ü/4L

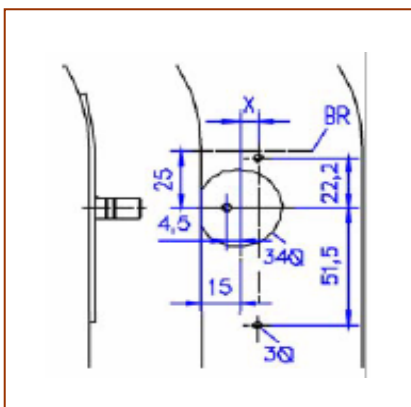

TO 18Ü/4L

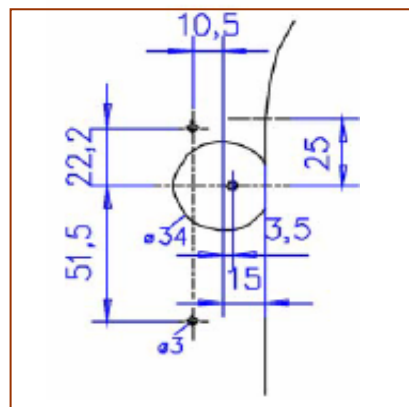



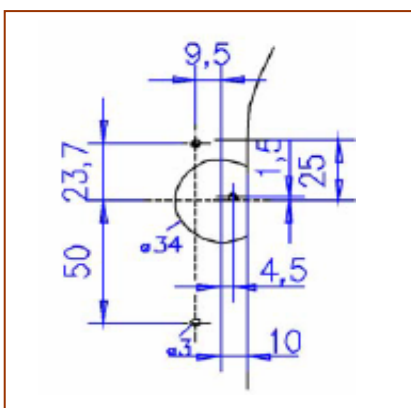

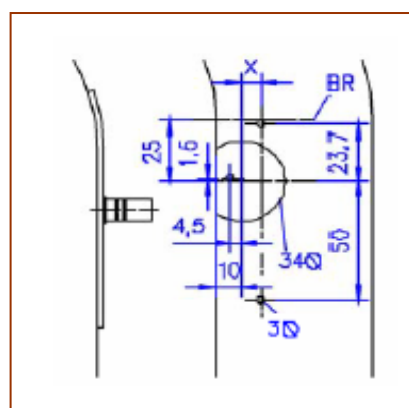

TO 20Ü/4L

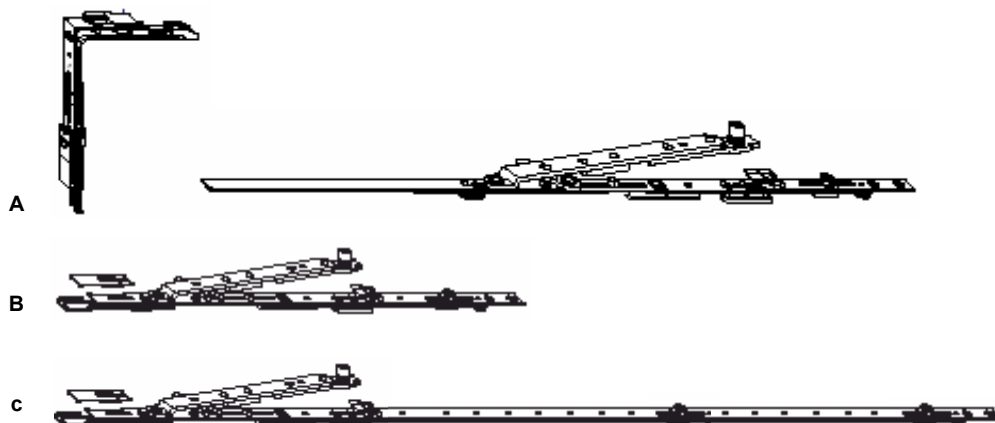

TO 18Ü/12L





 Argintiu N 	Foarfece TO	Z	L			
A 10836	Gr. 0 cu coltar de legatura Tip B	582	659	390 - 500	370 - 620	10
B 10978	Gr. 1 i.S	384	461	-	370 - 620	10
C 10726	Gr. 2 i.S	384/894	1075	-	621 - 1250	10



 Argintiu N 	Foarfece II		
A 10530	cu role de inchidere	FFB > 1070	10

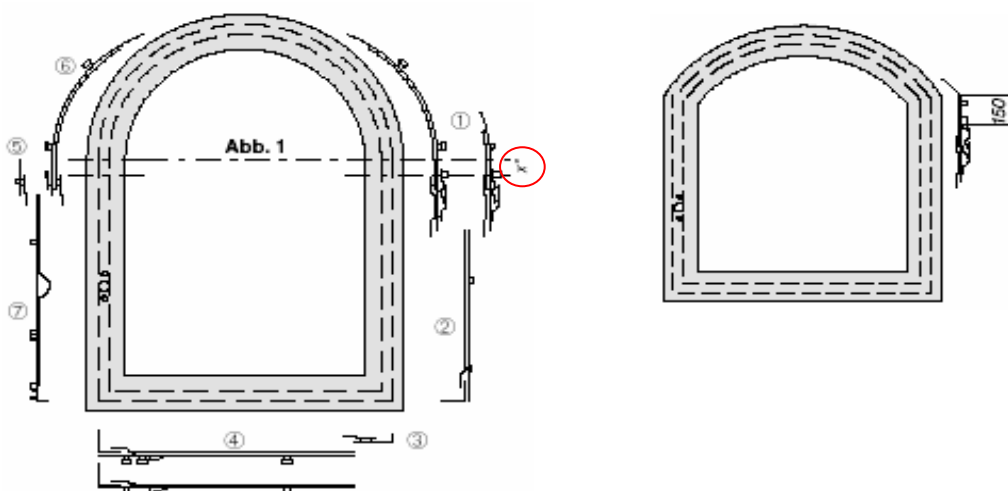

	x
TO	25 mm
DT	44 mm



Informatii tehnice

Mecanisme

A				10528	3
				<hr/>	
B				52496	3
				10538	3



Transmisie orizontal-basculanta

A			Gr.1	2
			Gr.2	3
<hr/>				
B			Gr.3	4
			Gr.4	5



Transmisie de colt

A			Gr.1	2
			Gr.2	3
<hr/>				
B			Gr.3	4
			Gr.4	5



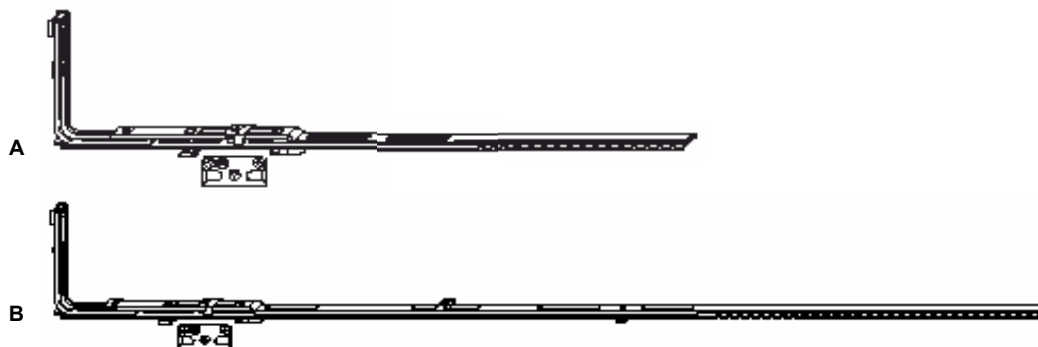

	Argintiu N ₀	Mecanisme pentru fereastra cu arcada	
A	10528	Coltar de legatura - set	10
B	52496	Inchizator final superior miscare 180*	10
C	10538	Inchizator final superior miscare 90*	20

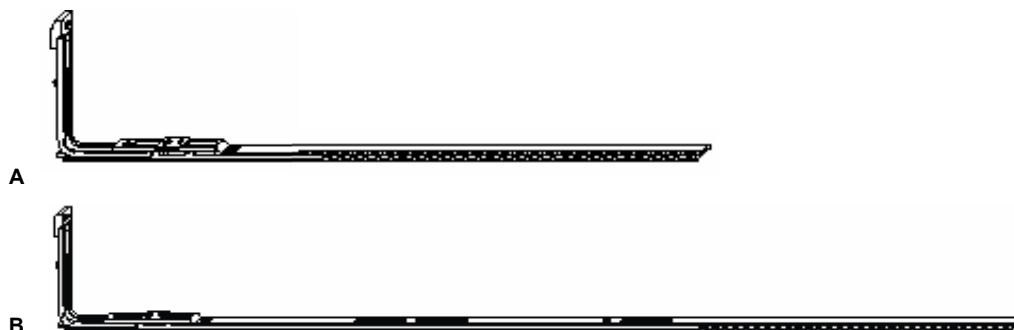

	Argintiu N ₀	Transmisie orizontal-basculanta pentru fereastra cu arcada	Z	L		
A	52782	Gr. 1 A i.S. Inchidere orizontal-basculanta	175	475	450 - 620	10
	52783	Gr. 2 i.S. Inchidere orizontal-basculanta	175	725	621 - 870	10
B	52784	Gr. 3 i.S. Inchidere orizontal-basculanta	175/528	922	821 - 1070	20
	52785	Gr. 4 i.S. Inchidere orizontal-basculanta	175/628	922	1071 - 1250	20



	Argintiu N ₀	Transmisie de colt pentru fereastra cu arcada	Z	L		
A	52490	Gr. 1 Transmisie de colt	-	475	500 - 750	10
	52491	Gr. 2 Transmisie de colt	-	725	751 - 1000	10
B	52912	Gr. 3 i.S. Transmisie de colt	582	822	820 - 1070	10
	52913	Gr. 3 i.S. Transmisie de colt	628	1192	1070 - 1250	10



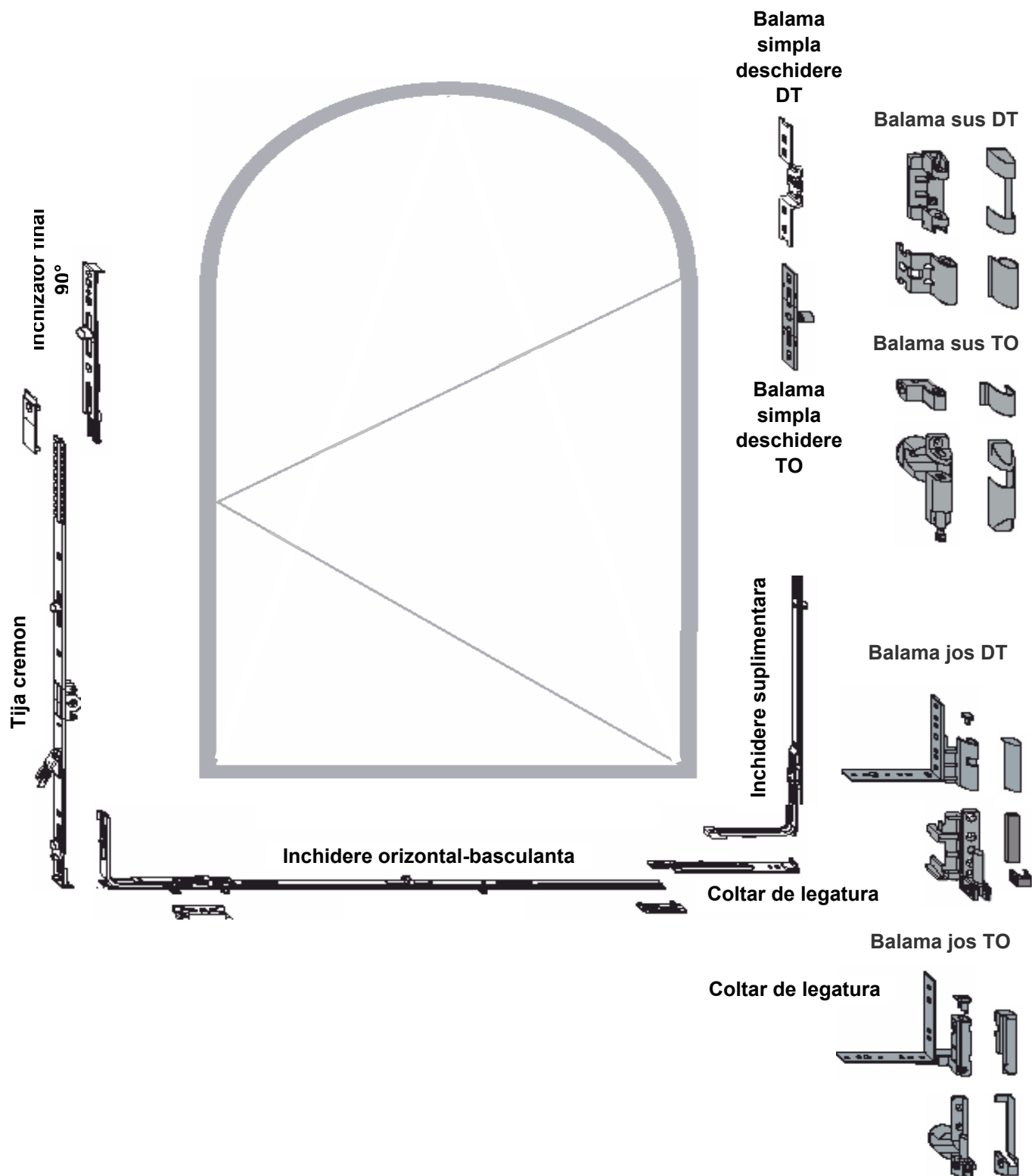



Informatii tehnice

Mecanisme pentru fereastra cu arcada

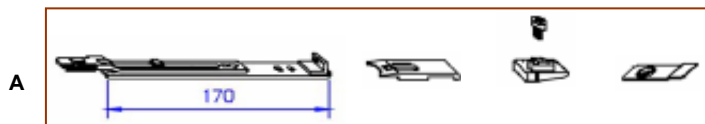

10528	3

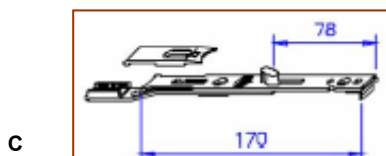
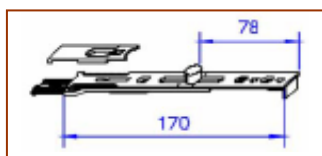

52496	3
10538	3

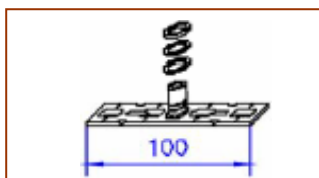
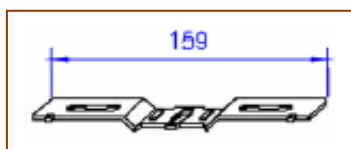

52468	4
54775	4

Transmisie orizontal-basculanta

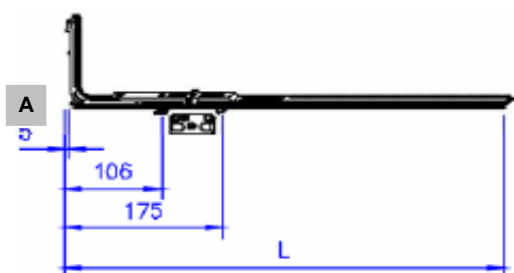

Gr.1	2
Gr.2	3

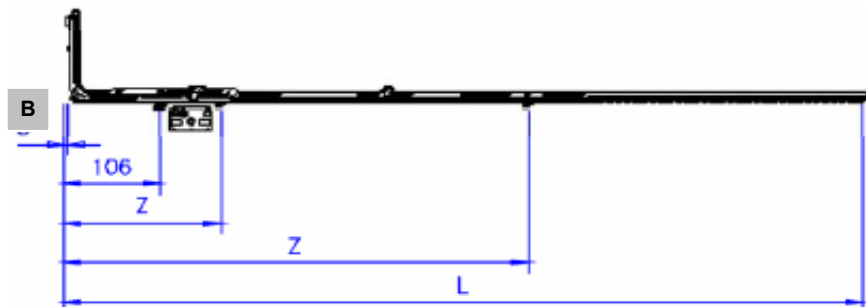

Gr.3	4
Gr.4	5

Transmisie de colt

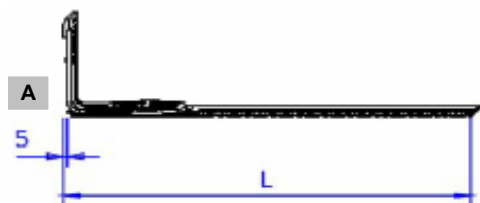

Gr.1	2
Gr.2	3

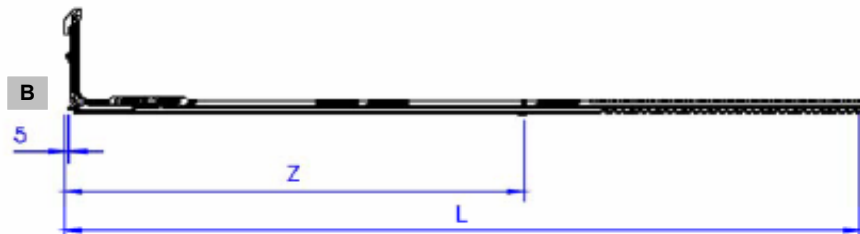

Gr.3	4
Gr.4	5



	Argintiu N ₁₀	Mecanisme pentru fereastra cu arcada	
A	10528	Coltar de legatura - set	10
B	52496	Inchizator final superior miscare 180*	10
C	10538	Inchizator final superior miscare 90*	20
D	52468	Balama simpla deschidere DT	100
E	54775	Balama basculanta TO	100

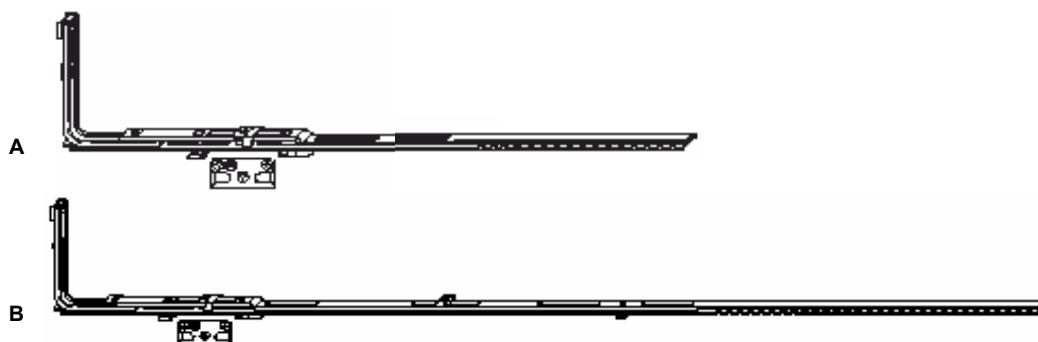

	Argintiu N ₁₀	Transmisie orizontal-basculanta pentru fereastra cu arcada	Z	L		
A	52782	Gr. 1 A i.S. Inchidere orizontal-basculanta	175	475	450 - 620	10
	52783	Gr. 2 i.S. Inchidere orizontal-basculanta	175	725	621 - 870	10
B	52784	Gr. 3 i.S. Inchidere orizontal-basculanta	175/528	922	821 - 1070	20
	52785	Gr. 4 i.S. Inchidere orizontal-basculanta	175/628	922	1071 - 1250	20



	Argintiu N ₁₀	Transmisie de colt pentru fereastra cu arcada	Z	L		
A	52490	Gr. 1 Transmisie de colt	-	475	500 - 750	10
	52491	Gr. 2 Transmisie de colt	-	725	751 - 1000	10
B	52912	Gr. 3 i.S. Transmisie de colt	582	822	820 - 1070	10
	52913	Gr. 3 i.S. Transmisie de colt	628	1192	1070 - 1250	10



Deschidere Oscilo - Batanta

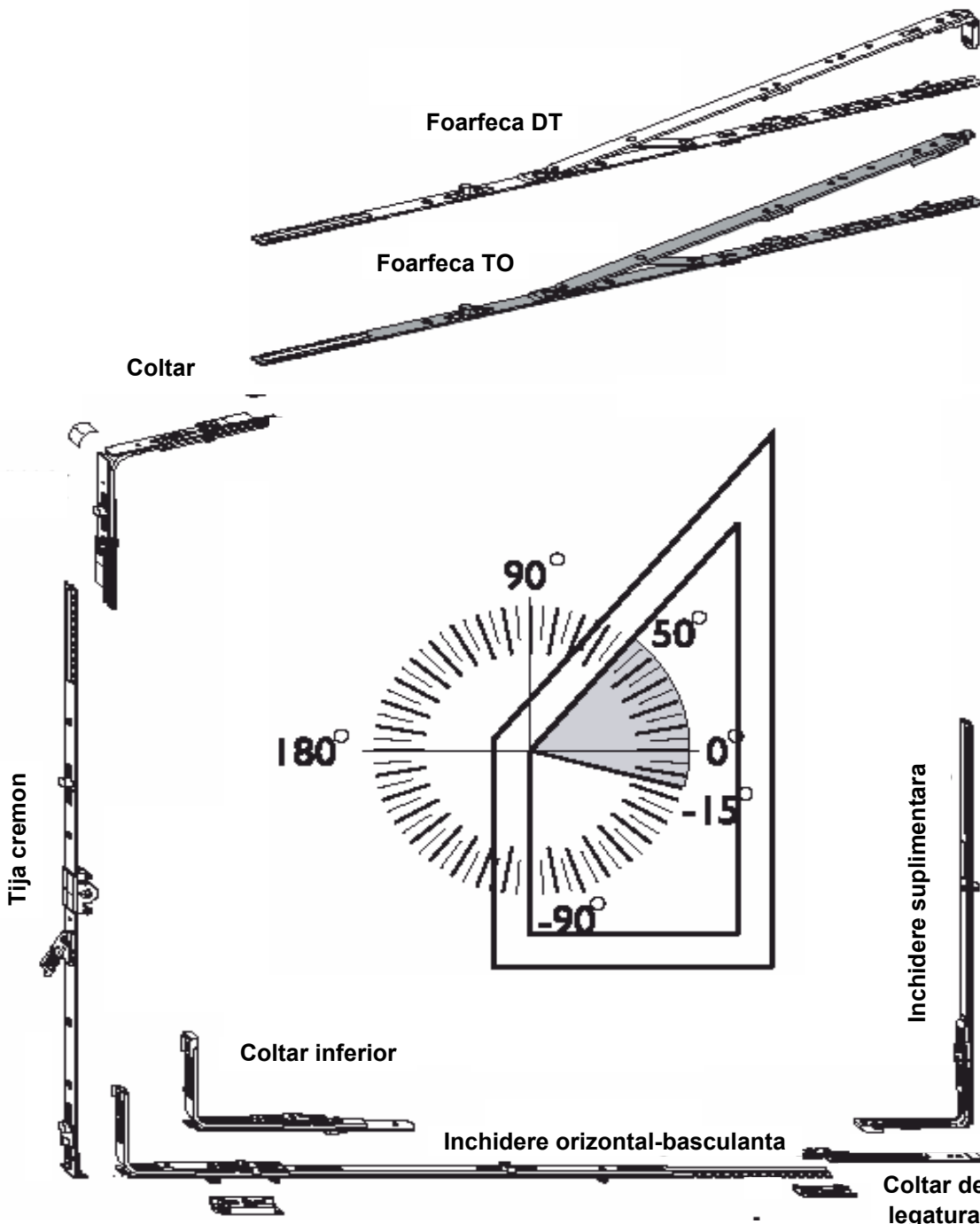

Balama sus DT

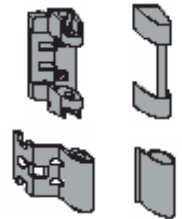

Balama sus TO

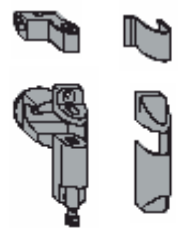

Balama jos DT

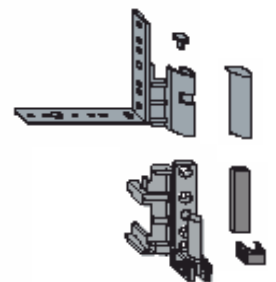

Balama jos TO

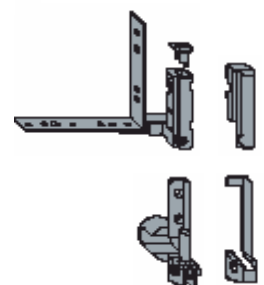

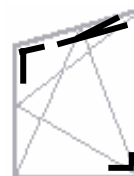

Informatii tehnice

Coltar de legatura - set

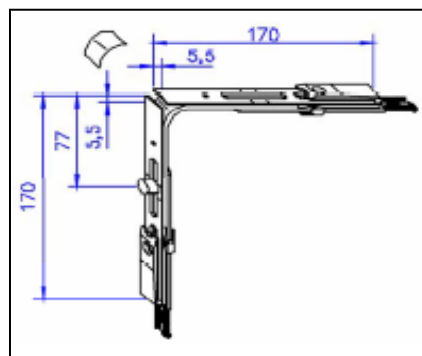
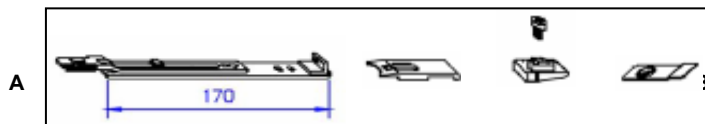

10528	3
10531	3

Foarfece DT pentru fereastră trapez



Gr.0	3
Gr.1	4
Gr.2	5
Gr.3	6

Foarfece TO pentru fereastră trapez



Gr.0	3
Gr.1	4
Gr.2	5
Gr.3	6

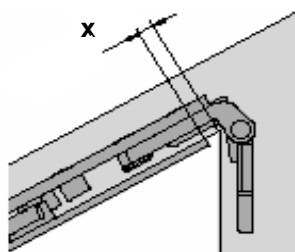

varianta DT

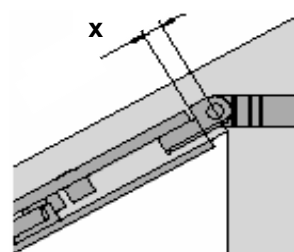

varianta TO

unghi	x	unghi	x
50°	0,6 mm	15°	2,5 mm
45°	1,2 mm	10°	2,5 mm
40°	1,7 mm	5°	2,4 mm
35°	2,1 mm	0°	2,3 mm
30°	2,3 mm	-5°	2,0 mm
25°	2,5 mm	-10°	1,8 mm
20°	2,5 mm	-15°	1,4 mm

unghi	x	unghi	x
50°	2 mm	15°	6 mm
45°	3 mm	10°	6 mm
40°	4 mm	5°	7 mm
35°	4 mm	0°	—
30°	5 mm	-5°	8 mm
25°	5 mm	-10°	9 mm
20°	6 mm	-15°	9 mm

varianta DT

unghi	A
18 mm	7 mm
20 mm	9 mm

unghi	x	unghi	x
50°	36,2 mm	15°	25 mm
45°	33,5 mm	10°	24 mm
40°	31 mm	5°	23,5 mm
35°	29,5 mm	0°	23 mm
30°	28 mm	-5°	23 mm
25°	26,5 mm	-10°	22,5 mm
20°	25,5 mm	-15°	22,5 mm

varianta TO

unghi	x	unghi	x
50°	16 mm	50°	27,5 mm
45°	14 mm	45°	24 mm
40°	13 mm	40°	21 mm
35°	11 mm	35°	18 mm

MACO MULTI TREND

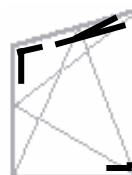

	Argintiu N	Mecanisme pentru fereastra trapez	
A	10528	Coltar de legatura - set	10
B	10531	Coltar superior pentru ferestre trapez	20



	Argintiu N	Foarfece DT pentru fereastra trapez	Z	L		
A	52497	Gr. 0	-	475	430 - 630	10
	52498	Gr. 1	-	670	500 - 800	10
B	52499	Gr. 2	528	920	801 - 1050	10
	52500	Gr. 3	628	1160	1051 - 1300	10

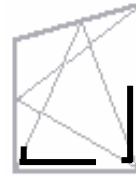
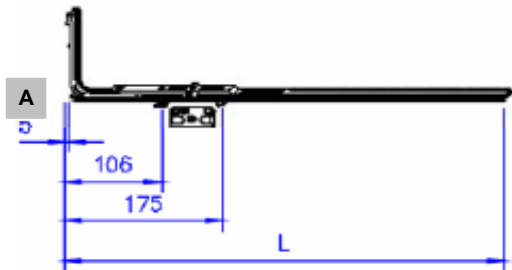

	Argintiu N	Foarfece TO pentru fereastra trapez	Z	L		
A	55152	Gr. 0	-	475	430 - 630	10
	55376	Gr. 1	-	670	500 - 800	10
B	55377	Gr. 2	528	920	801 - 1050	10
	55378	Gr. 3	628	1160	1051 - 1300	10

MACO MULTI TREND**Informatii tehnice****Transmisie orizontal-basculanta**

	
Gr.1	2
Gr.2	3

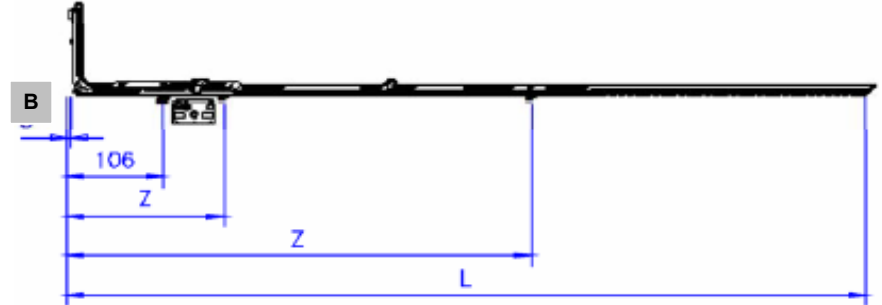

	
Gr.3	4
Gr.4	5

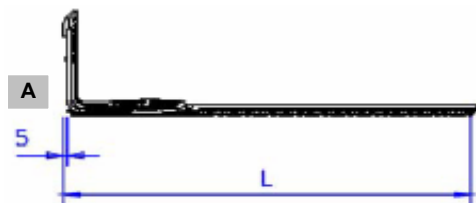
Transmisie de colt

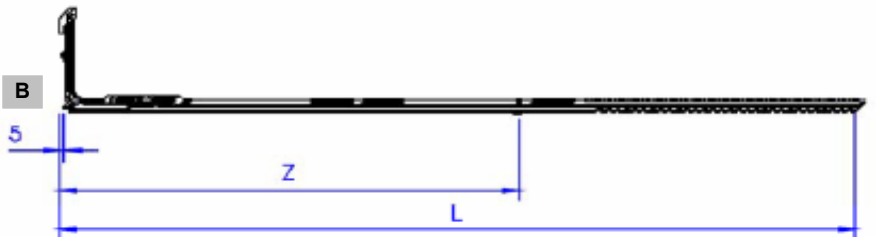

	
Gr.1	2
Gr.2	3



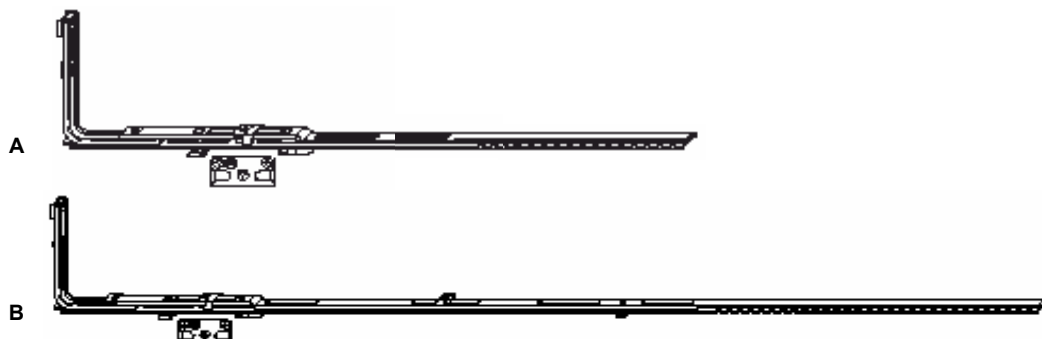
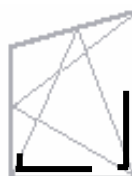

	
Gr.3	4
Gr.4	5

MACO MULTI TREND



	Argintiu N ^o	Transmisie orizontal-basculanta pentru fereastră trapez	Z	L		
A	52782	Gr. 1 A i.S. Inchidere orizontal-basculanta	175	475	450 - 620	10
	52783	Gr. 2 i.S. Inchidere orizontal-basculanta	175	725	621 - 870	10
B	52784	Gr. 3 i.S. Inchidere orizontal-basculanta	175/528	922	821 - 1070	20
	52785	Gr. 4 i.S. Inchidere orizontal-basculanta	175/628	922	1071 - 1250	20



	Argintiu N ^o	Transmisie de colt pentru fereastră trapez	Z	L		
A	52490	Gr. 1 Transmisie de colt	-	475	500 - 750	10
	52491	Gr. 2 Transmisie de colt	-	725	751 - 1000	10
B	52912	Gr. 3 i.S. Transmisie de colt	582	822	820 - 1070	10
	52913	Gr. 3 i.S. Transmisie de colt	628	1192	1070 - 1250	10





MACO MULTI TREND

Deschidere Batanta

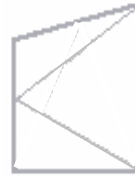

Balama simpla deschidere DT



Balama simpla deschidere TO



Balama sus DT

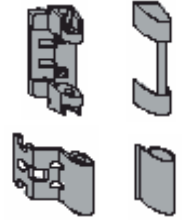

Balama sus TO

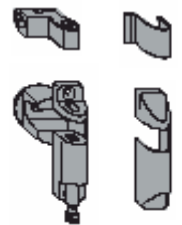

Balama mijloc



Balama jos DT

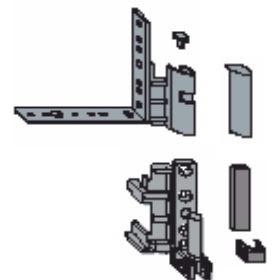

Balama jos TO

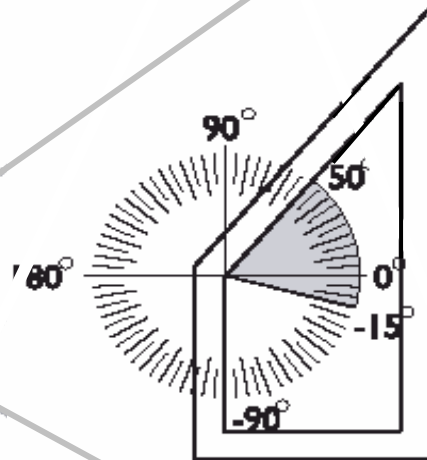
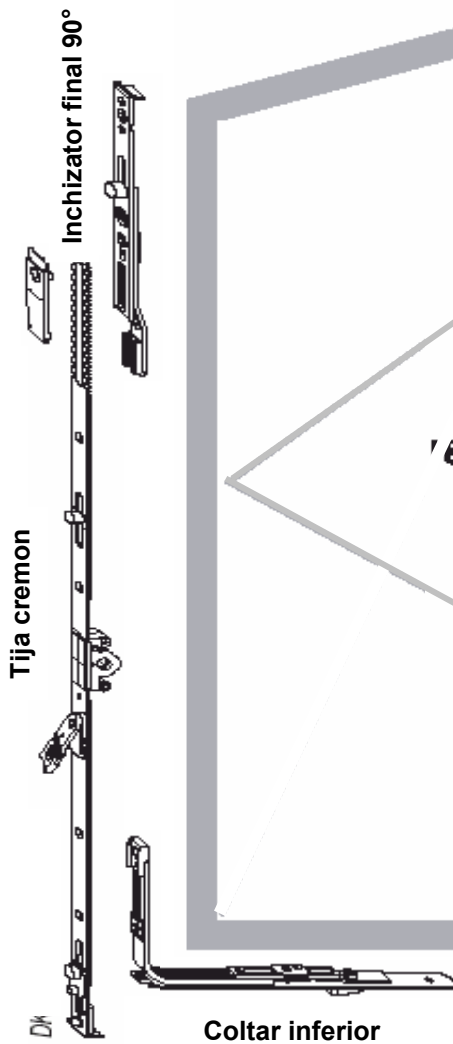
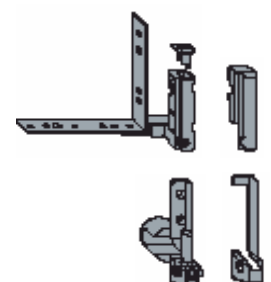



MACO MULTI TREND

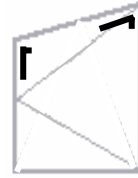

Informatii tehnice

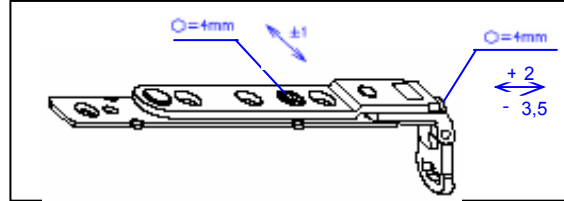
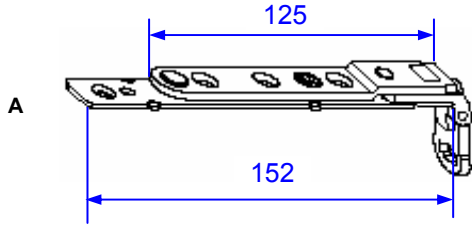

52501	4

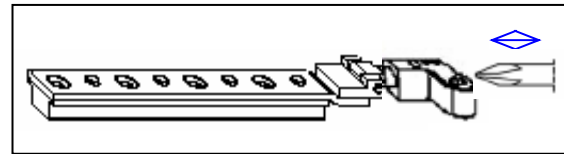

10936	4

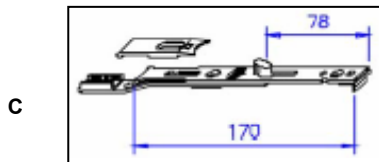
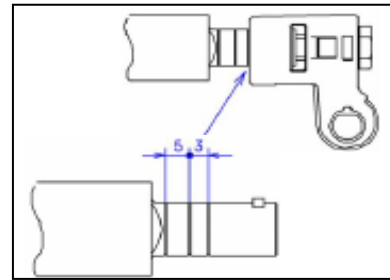

10538	3

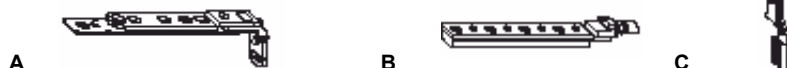
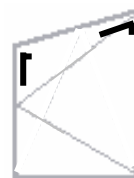
MACO MULTI TREND

H	Argintiu N 10	Mecanisme pentru fereastra trapez	
A	52501	Balasma batanta DT pentru ferestre trapez	50
B	10936	Balama batanta TO pentru fereste trapez	20
C	10538	Inchizator final superior miscare 90*	20

MACO MULTI TREND

Sabloane

A Sablon pentru pozitionarea balamalelor DT pe toc

Nº 20890

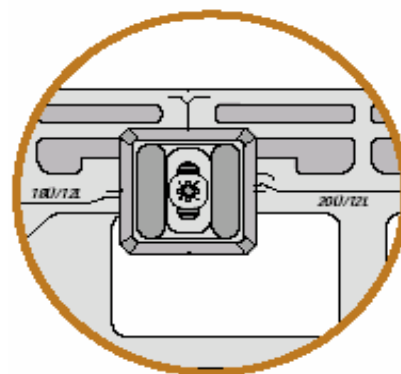
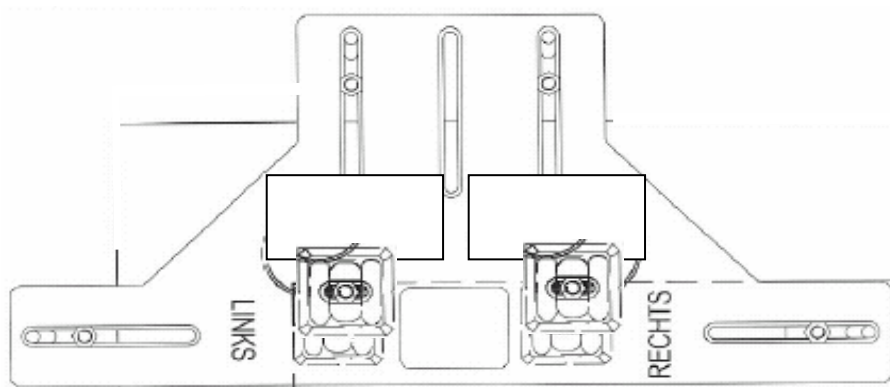

B Sablon pentru pozitionarea balamalelor TO pe toc

Nº 21725

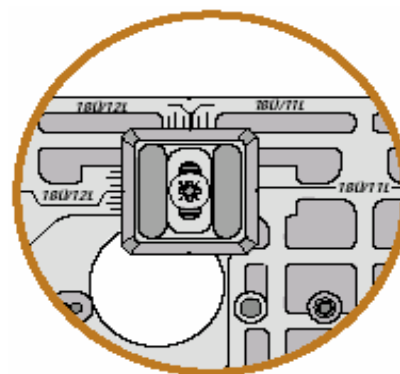
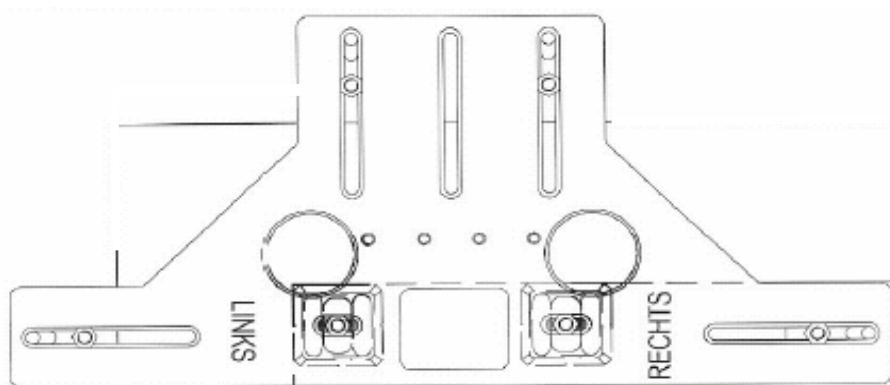

c Maner de lucru

Nº 28620

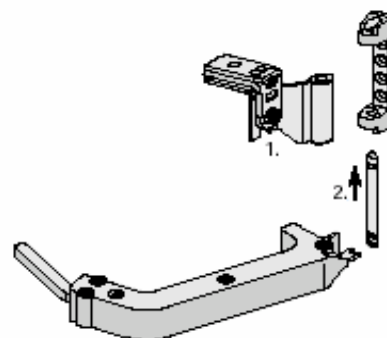
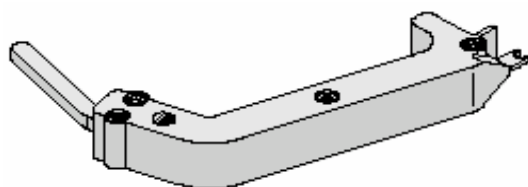

d Cheie T20 pentru cuplarea balamalei de cercevea sus DT

Nº 40680

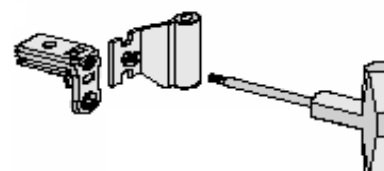
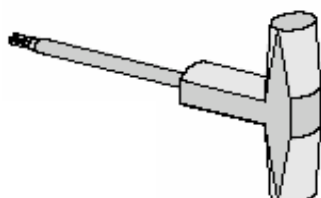

MACO MULTI TREND

Sabloane

E Cheie pentru deblocarea sigurantei

№ 24239

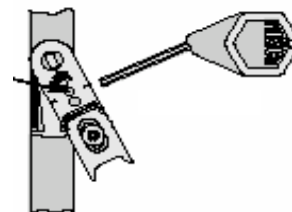
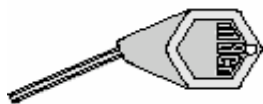

F Cheie imbus 4 mm pentru reglaj

№ 41017

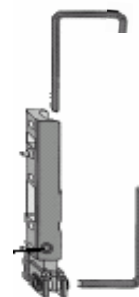
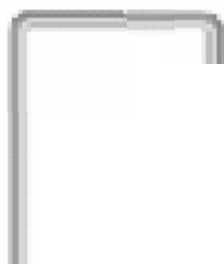

G Cheie T15 pentru reglaj

№ 44192 (43647)

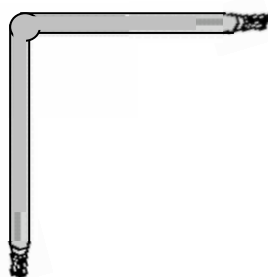

H Cheie pentru reglarea rozelor de inchidere

№ 20947

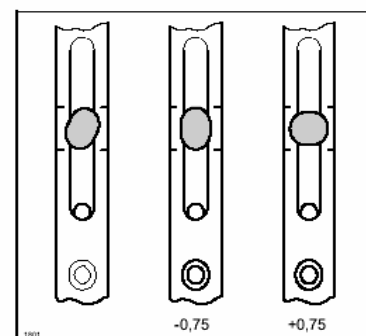



Für das Beschlagsystem

MACO MULTI-TREND

und die darin enthaltenen Bandseiten

TR, AS, DT und TO

geben wir

10 Jahre Garantie

Die MAYER & CO Beschläge GmbH, A-5020 Salzburg, Alpenstraße 173, gibt für das Beschlagsystem MACO MULTI-TREND und die darin enthaltenen Bandseiten TR, AS, DT und TO über die gesetzliche Gewährleistung hinaus eine **Garantie von insgesamt 10 Jahren**.

Die MAYER & CO Beschläge GmbH garantiert, dass in den genannten Bandseiten keine sicherheitsrelevanten Teile brechen und auch in den verketteten Bauteilen kein Bruch entsteht.

Im Garantiefall leisten wir kostenlosen Ersatz der defekten Teile.
Weitere Kostenerstattungen unsererseits sind ausgeschlossen.

Diese Zusage gilt unter der Voraussetzung, dass der Beschlag entsprechend unseren gültigen Einbauanleitungen fachgerecht montiert wurde, nach unseren Bedienungsangaben korrekt betätigt wird und die Wartung nach unseren Wartungsanleitungen nachweislich durchgeführt wird.

Eine Garantie für die Oberflächenqualität kann nur dann übernommen werden, wenn keine aggressiven Umwelteinflüsse von außen auf die Beschläge einwirken, keine aggressiven Putzmittel angewendet wurden oder aggressive Stoffe aus dem Fensterwerkstoff den Beschlag angreifen (z.B. Hölzer mit aggressiven Inhaltsstoffen).

Die über die gesetzliche Gewährleistung hinausgehende 10-Jahres-Garantie beginnt mit dem Tag der Ablieferung der Ware.



MAYER & CO Beschläge GmbH, A-5020 Salzburg, Alpenstraße 173, Telefon: +43 (0)662 6196-0,
Telefax: +43 (0)662 6196-101, E-Mail: maco@maco.at, Internet: <http://www.maco.at>

Pentru consultanta tehnica apelati:

Florin Grigore

Mob: 0742 150 368

E-mail: f.grigore@macoromania.ro

f.grigore@maco.at

MACO MULTI TREND

Feronerie pentru Ferestre din Lemn si Lemn Stratificat

MACO
MULTI-TREND



MACO ROMANIA
g.adamov@macoromania.ro
f.grigore@macoromania.ro
www.maco.at

MAYER & CO BESCHLÄGE GMBH
ALPENSTRASSE 173
A-5020 SALZBURG
TEL: +43 (0)662 6196-0
FAX: +43 (0)662 6196-101
maco@maco.at
www.maco.at

MACO BESCHLÄGE GMBH
HAIDHOF 3
D-94508 SCHÖLLNACH
TEL: +49 (0)9903 9323-0
FAX: +49 (0)9903 9323-199
d-maco@maco.de
www.maco.de

MAICO SRL
ITALIEN
maico@maico.com

**MACO DOOR & WINDOW
HARDWARE LTD**
GROSSBRITANIEN
maco@macouk.net

**MACO HARDWARE
(TIANJIN) CO., LTD**
CHINA
j.zhang@maco.at

MACO-BESCHLÄGE B.V.
NIEDERLANDE
info@maco-nl.nl

MACO-POLSKA
POLEN
maco@maco.pl

DIE UNTERNEHMEN DER MACO-GRUPPE

Best.-Nr. 49427_DE - Datum: Jänner 2006
Alle Rechte und Änderungen vorbehalten.