

Distribuidor BZD-BZV 180C

BZD-BZV 180C Tipping Valve

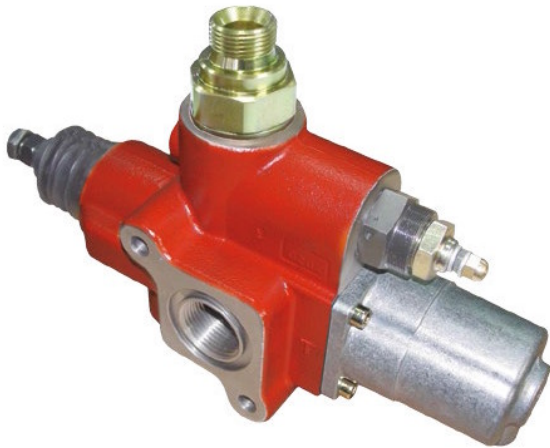

Descripción Description

Válvula para volquete, centro abierto proporcional o centro cerrado de 2 velocidades de bajada de 180 litros. En el caso de las válvulas de centro abierto proporcional, disponemos de válvulas limitadoras compensadas con selector del rango de presión.

180 litres proportional open circuit or close circuit tipping valve, pneumatic operated, with 400 bar relief valve. In the case of proportional centre-opening valves, we have compensated limiting two pressures or between 140.

Datos Principales Main Data						
Modelo Model	BZDP 180C			BZDP 180C (Tirador/Puller)	BZV-2V 180C	BZVP 180C
Codigo Part Number	9028990/2	9029090/2 (2 presiones) (2 pressures)	9029190/2 (3 presiones) (3 pressures)	9036090/2	9032190/2	9031790/2
Taraje Setting (BAR)	180	150 250	140 220 340	180		
Caudal de entrada Input Flow	180 L			180 L		
Presión Máx. Max. pressure	400 Bar			400 Bar		
Rosca Thread	1" BSP			1" BSP		
Peso Weight (Kg)	7.70					

Esquemas hidráulicos Hydraulic Diagrams

BZDP 180C
9028990/2, 9029090/2
9029190/2

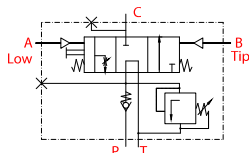

BZV 180C-2V
9032190/2

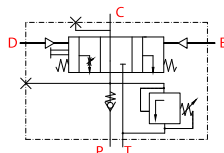

BZDP 180C (Tirador/Puller)
9036090/2

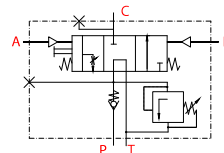

BZVP 180C
9031790/2

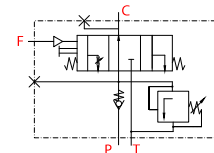

(*) Ver notas See notes

Distribuidor BZD-BZV 180C

BZD-BZV 180C Tipping Valve

BZDP 180C (9028990/2, 9029090/2, 9029190/2)

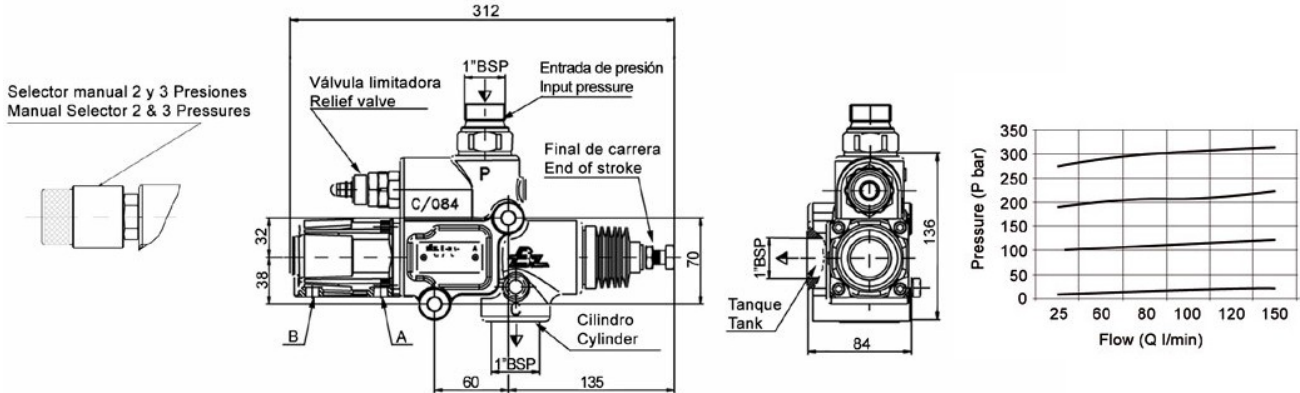

BZV 180C-2V (9032190/2)

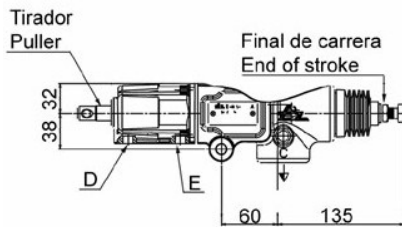

BZDP 180C - Tirador/Puller 9036090/2

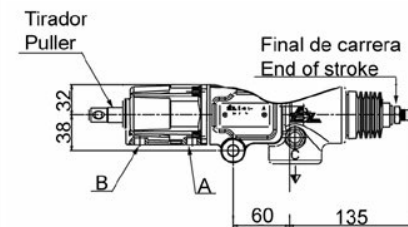

BZVP 180C 9031790/2

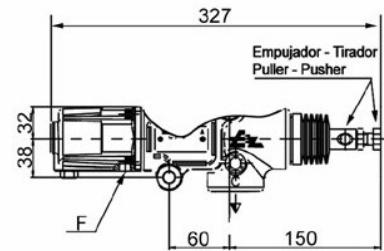

Opcional Codigo: 9033490 Optional Part Number: 9033490

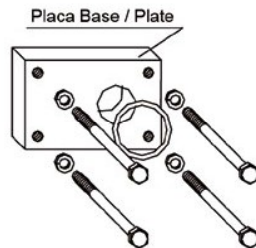

Importante:
Par de apriete max. para tornillos placa base: 20 Nm

Important:
Max. torque wrench for base plate screws: 20 Nm

Notas Notes

A	Bajada 1/8" GAS	A	Low 1/8" BSP
B	Subida 1/8" GAS	B	Tip 1/8" BSP
D	Bajada rápida 1/8" GAS	D	Rapid descent 1/8" BSP
E	Bajada lenta 1/8" GAS	E	Slow descent 1/8" BSP
F	Bajada proporcional 1/8" GAS	F	Proportional descent 1/8" BSP