

TECHNOLOGY IN MOTION



INDUSTRIAL



POWER GEN



WIND ENERGY

SMT series

Dry & submersible screw pumps
for industrial applications - 80 bar pressure

Serie / Series
SMT / S

Aspirazione A
Axial suction

IN-F

Ø D3

IN-AX

Ø D2

Ø F1

Ø F2

Ø D1

H2

OUT

IN-Rd

CA

N° X
Y



SMT pump series / Serie SMT

Three screw pumps

Three screw pumps represent the largest class of multiple screw pumps in service today. No matter the applications and the environmental conditions, three screw pump is the most flexible pump on the market.

Well known to be very reliable, at reasonable cost, virtually pulsation-free flow, very low acoustic emissions, three screw pumps are extensively used in meeting the requirements of oil & gas, chemical, marine, industrial, mobile, alternative energy, food processing, paper, power gen, pharmaceutical and many other industries.

SMT three screw pumps represent one of the most used pump series all over the world after thirty five years of experience.

Le pompe a tre viti

Le pompe a tre viti, oggi, rappresentano la classe di pompe a viti maggiormente utilizzate, indipendentemente dal tipo di applicazione e dalle condizioni ambientali, in quanto sono le più flessibili sul mercato. Sono considerate le più affidabili, a prezzi ragionevoli, e raggiungono bassissimi livelli di emissioni acustiche e assenza di vibrazioni nella trasmissione del flusso. Le pompe a tre viti sono ampiamente utilizzate in quanto rispettano i requisiti di settori quali oil & gas, chimico, navale, mobile, agroalimentare, power generation ed energie alternative, industria della carta, industria farmaceutica e molte altre.

*Le pompe a tre viti della serie **SMT**, sono tra le più usate in tutto il mondo e vantano oltre trent'anni di esperienza.*

No pulsation – smooth flow. Low noise

SMT three screw pumps are designed to avoid any pulsation, to ensure a smooth operation and to reduce to the lowest level the acoustic emissions reducing all costs of second noise reduction measures.

The pulsation-free flow of **SMT** pumps allows Settima screw pumps also in output condition management critical to applications such as precision hydraulic controls and fuel metering.

Flusso omogeneo – Nessuna pulsazione. Basse emissioni acustiche

*Le pompe a tre viti della serie **SMT** sono progettate per eliminare le pulsazioni, assicurare un funzionamento omogeneo e ridurre al minimo le emissioni acustiche, riducendo in questo modo i costi legati alla necessità di ricorrere a misure secondarie per la riduzione del rumore.*

*Il flusso privo di pulsazioni delle pompe **SMT**, permette l'applicazione delle pompe Settima anche in condizioni critiche, come ad esempio idraulica di precisione, dosaggio e misurazione di carburanti.*

Magnetic coupling sealless leakage free pumps - FGM option

SMT pump can be equipped with a magnetic coupling if required. The hermetically sealed magnetic coupling is a permanent magnetic synchronous coupling able to transmit torque through magnetic forces between the internal and external rotor. Applying a magnetic coupling, the drive and the driven sides are hermetically separated. In case of critical media the magnetic coupling is a reliable seal and avoids any serious leaking. The magnetic coupling is the containment shroud that is fixed to the driven sided power unit and separates internal and external rotor from each other. Due to the absence of mechanical connection the vibrations torque transmission are very low, with completely leak-proof separation of product and atmosphere.

The magnetic coupling is used to ensure no media leaking or when working in environments with potentially explosive atmospheres.



Giunto magnetico senza tenute rotanti assenza di perdite garantita - Opzione FGM

*Le pompe **SMT** possono, su richiesta, essere dotate di giunto magnetico. Il giunto magnetico permette di sigillare l'accoppiamento che trasmette la coppia tra il rotore interno ed esterno tramite forza magnetica. Con l'applicazione del giunto magnetico, l'elemento di trasmissione e quello condotto sono ermeticamente separati. In caso di fluidi pericolosi, il giunto magnetico garantisce una tenuta affidabile che impedisce perdite. Il giunto magnetico consiste nella copertura fissata sull'elemento condotto che separa il rotore interno da quello esterno. Grazie all'assenza di connessioni meccaniche, le vibrazioni dovute alla trasmissione di potenza sono molto ridotte, senza possibilità di contaminazione dell'atmosfera da parte del fluido e viceversa. Il giunto magnetico è utilizzato per prevenire in modo sicuro perdite*

Technical characteristics / Caratteristiche tecniche

Types <i>Tipi</i>	Dry (SMT) or submerged (SMIT) <i>Esterno (SMT) o sommerso (SMIT)</i>	
Models <i>Modelli</i>	20 – 25 – 32 – 40 – 45 – 55 – 60 – 70 – 80 – 90	
Installation <i>Installazione</i>	Free for SMT. Submerged (totally or partially) for SMIT <i>Qualsiasi per SMT. Sommersa (parzialmente o completamente) per SMIT</i>	
Flanges <i>Flange</i>	ISO 3019/2	
Connections <i>Conessioni</i>	SAE 3000 - BSPP	
Drive loading <i>Carichi</i>	No axial or radial loads <i>Nessun carico assiale o trasversale</i>	
Shaft rotation <i>Rotazione albero</i>	Clockwise (from shaft end) , (suitable also for counter clockwise rotation) <i>Destra (disponibile anche per rotazione sinistra)</i>	
Shaft speed <i>Velocità di rotazione</i>	From 500 to 3.600 rpm ⁽¹⁾ <i>Da 500 a 3.600 rpm⁽¹⁾</i>	
Flows <i>Portate</i>	From 4 up to 1.220 L/min <i>Da 4 a 1.220 L/min</i>	
Outlet Pressure <i>Pressione di mandata</i>	Up to 80 bar <i>Fino a 80 bar</i>	
Inlet Pressure <i>Pressione in aspirazione</i>	Min. -0.7 bar max. 3 bar ⁽²⁾ <i>Min. -0.7 bar max. 3 bar⁽²⁾</i>	
Fluids ⁽³⁾ <i>Fluidi⁽³⁾</i>	<ul style="list-style-type: none"> Mineral oil HLP e HVLP Ecologic fluids HETG, HEPG, HEE Synthetic fluid or emulsion: HFA oil-water emulsion, HFB water-oil emulsion 40% of volume, HFC water/glycole – water max 35 to 55%, HFDR phosphate ester Lubrication high viscosity oils Special synthetic fluid: MIL-H, SKYDROL, Fuel oil: MGO, MDO, Low sulfur MDO and HFO DMX (ISO8217), DMA, DMB, DMC, DMZ Bunker oil, furnace oil, engines oil, heating oil, hydraulics oils DIN 51524 	<ul style="list-style-type: none"> Oli minerali HLP e HVLP Fluidi ecologici HETG, HEPG, HEE Fluidi sintetici o emulsioni: HFA emulsione olio-acqua, HFB emulsione acqua-olio 40% dl volume, HFC acqua/glicole – acqua max 35 to 55%, HFDR phosphate ester Olio ad alta viscosità per lubrificazione Fluidi speciali sintetici: MIL-H, SKYDROL, Fuel oil: MGO, MDO, Basso livello di zolfo MDO e HFO DMX (ISO8217), DMA, DMB, DMC, DMZ Bunker oil, furnace oil, olio per motori, heating oil, olio idraulico DIN 51524
Viscosity <i>Viscosità</i>	From 2 up to 10.000 cSt ⁽⁴⁾ <i>Da 2 fino a 10.000 cSt⁽⁴⁾</i>	
Seals polymer (shaft, O-ring) <i>Polimero guarnizioni (albero, anello di tenuta)</i>	NBR, FKM, EPDM ⁽⁵⁾	
Seal type <i>Tipo di tenuta</i>	TM, TMK, TMZ, FGM	
Acoustic Emissions <i>Emissioni Acustiche</i>	From 52 up to 68 db(A) at 2.950 rpm (value based on ISO 4412 test procedure) <i>Da 52 fino a 68 db(A) a 2.950 rpm (ISO 4412 test)</i>	
Pump body <i>Corpo pompa</i>	Extruded aluminum alloy <i>Alluminio estruso</i>	
Pump body (special applications) <i>Corpo pompa (applicazioni speciali)</i>	Cast iron, steel. Hardened steel and stainless steel available on request. <i>Ghisa, acciaio. Acciaio temprato e acciaio inox su richiesta.</i>	
Screws <i>Viti</i>	Steel for main screw , idler cast iron <i>Acciaio vite principale, ghisa viti secondarie</i>	
Screws (special applications) <i>Viti (applicazioni speciali)</i>	Core hardened steel screws, surface treated screws <i>Viti in acciaio temprato, viti trattate superficialmente</i>	
Environment temperature <i>Temperatura ambiente</i>	From -50° up to +60°C <i>Da -50° a +60°C</i>	
Hydraulic Temperature <i>Temperature olio</i>	From -50°C up to +300°C <i>Da -50°C a +300°C</i>	

All data reported by catalogue can change without any notice. I dati presenti nel catalogo possono cambiare senza preavviso.

(1) For shaft speed lower than 1.000 rpm and over 1.800 rpm please contact Settima. Per velocità inferiori a 1.000 rpm e maggiori di 1.800 rpm contattare Settima.

(2) For higher pressure please contact Settima. Per pressioni maggiori contattare Settima

(3) For request of different fluids please contact Settima. Per l'utilizzo di diversi fluidi contattare Settima.

(4) For level of viscosity lower than 20 cSt and over 320 cSt please contact Settima. Per livelli di viscosità inferiori a 20 cSt e superiori a 320 cSt contattare Settima.

(5) For special seals, contact Settima. Per tenute speciali, contattare Settima.

Product description / Descrizione prodotto

DIFFERENT COMBINATIONS OF SMT PUMP / DIFFERENTI COMBINAZIONI DELLA POMPA SMT

Flange configurations view / Configurazioni flangia

A

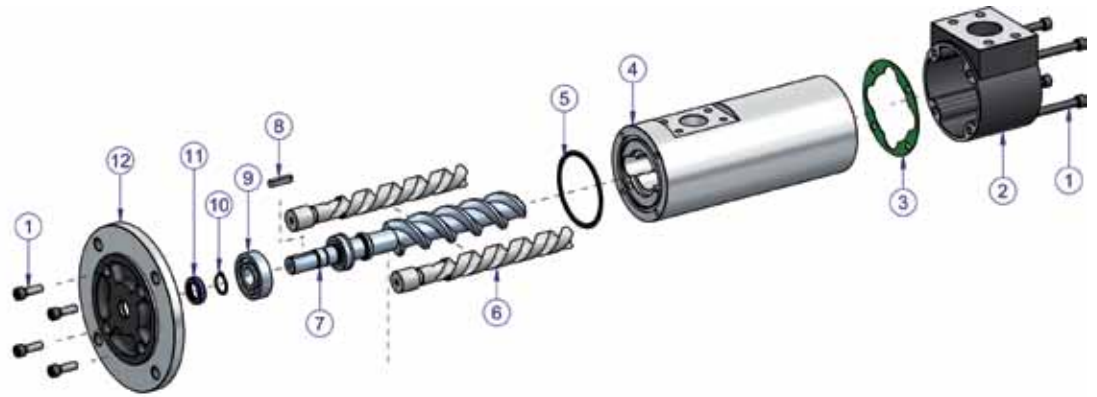

B

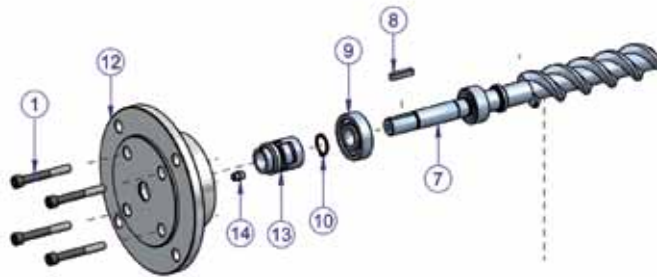

C



D

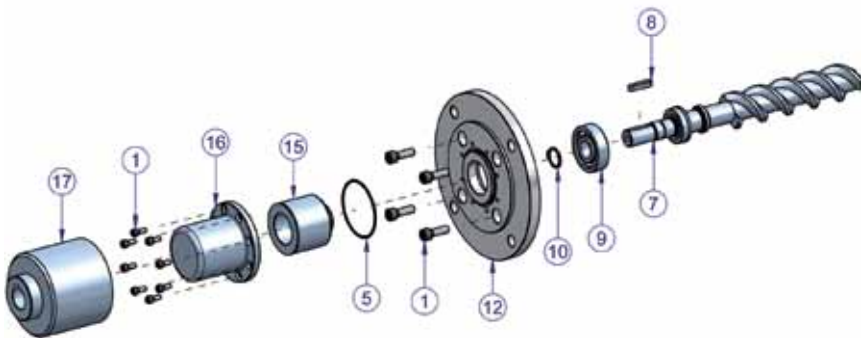

Product description / Descrizione prodotto

Shaft and seal options/ Opzioni alberi e tenute

N°	Parts description / Descrizione componenti	Material / Materiale
1	Screw / Vite	Common components
2	Radial suction cover / Tappa radiale	Common components
3	Plane gasket / Guarnizione piana	Common components
4	Pump body / Corpo pompa	Common components
5	O-ring / Anello O-ring	Common components
6	Idler screw / Vite laterale	Common components
A	SMT (LIP SEAL) / SMT (TENUTA A LABBRO)	
7	Main screw / Vite centrale	Common components
8	Key / Linguetta	Common components
9	Ball bearing / Cuscinetto	Common components
10	Seeger	Common components
11	Seal / Anello di tenuta	Common components
12	Flange / Flangia	Common components
1	Screw / Vite	Common components
B	SMT (MECHANICAL SEAL) - TM OPTION / SMT (TENUTA MECCANICA) - OPZIONE TM	
7	Main screw / Vite centrale	Common components
8	Key / Linguetta	Common components
9	Ball bearing / Cuscinetto	Common components
10	Seeger	Common components
13	Mechanical seal / Tenuta meccanica	Common components
14	Driving oil bushing / Boccola convoglia olio	Common components
12	Flange / Flangia	Common components
1	Screw / Vite	Common components
C	SMT HOLLOW SHAFT (LIP SEAL) / SMT ALBERO CAVO (TENUTA A LABBRO)	
7	Main screw / Vite centrale	Common components
9	Ball bearing / Cuscinetto	Common components
10	Seeger	Common components
11	Seal / Anello di tenuta	Common components
12	Flange / Flangia anteriore	Common components
1	Screw / Vite	Common components
D	SMT MAGNETIC COUPLING - FGM OPTION / SMT GIUNTO MAGNETICO - OPZIONE FGM	
7	Main Screw / Vite centrale	Common components
8	Key / Linguetta	Common components
9	Ball bearing / Cuscinetto	Common components
10	Seeger	Common components
12	Flange / Flangia anteriore	Common components
1	Screw / Vite	Common components
5	O-ring / Anello O-ring	Common components
15	Internal rotor MC / Rotore interno MC	Common components
16	Containment shroud MC / Cappuccio MC	Common components
1	Screw / Vite	Common components

Product description / Descrizione prodotto

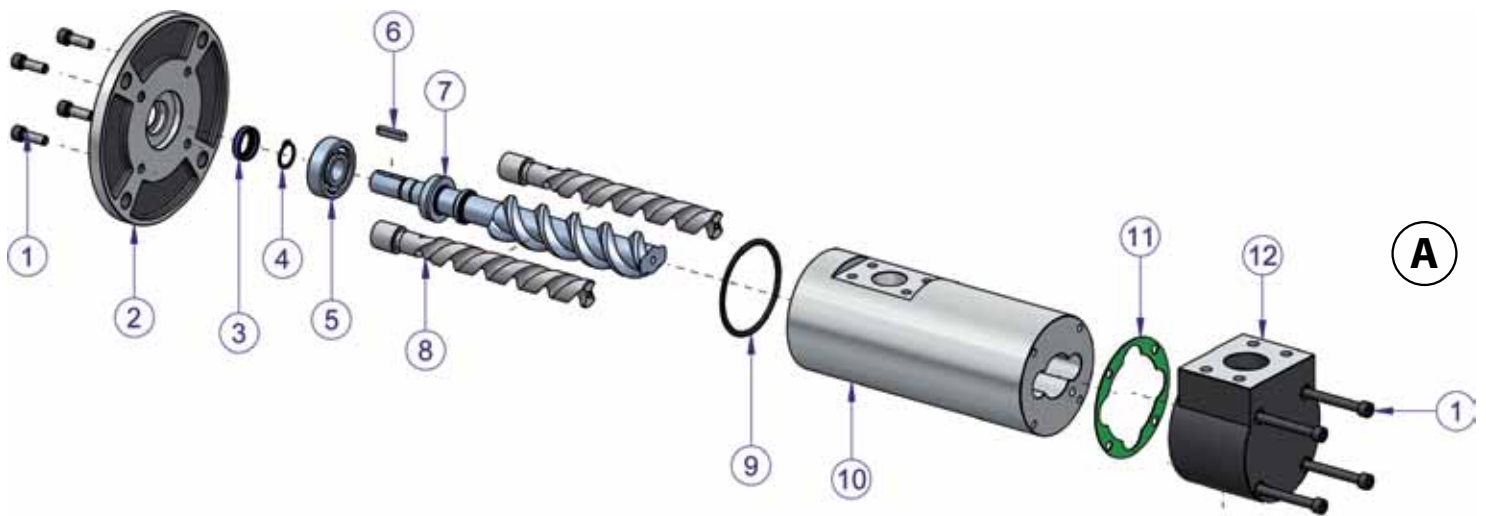

Suction port options / Opzioni porta di aspirazione

N°	DESCRIPTION/DESCRIZIONE	MATERIAL* / MATERIALE*
1	Screw / Vite	Common components
2	Flange / Flangia anteriore	Common components
3	Seal / Anello di tenuta	Common components
4	Seeger	Common components
5	Ball bearing / Cuscinetto	Common components
6	Key / Linguetta	Common components
7	Main screw / Vite centrale	Common components
8	Idler screw / Vite laterale	Common components
9	O-ring / Anello O-ring	Common components
10	Pump body / Corpo pompa	Common components
11	Plane gasket / Guarnizione piana	Common components
A	SMT	
12	Radial suction cover / Tappa radiale	Common components
1	Screw / Vite	Common components
B	SMT AX (AXIAL BSPP) / SMT AX (ASSIALE BSPP)	
1	Screw / Vite	Common components
12	Axial suction cover / Tappa assiale	Common components
C	SMT AL (TOP FLANGE FOR VERTICAL INSTALLATION OVER TANK) / SMT AL (TAPPA ASPIRAZIONE PER INSTALLAZIONE VERTICALE SOPRA SERBATOIO)	
1	Screw / Vite	Common components
12	Tank top flange / Tappa aspirazione sopra serbatoio	Common components
D	SMIT SUBMERSIBLE / SMIT SOMMERSA	
12	Filter / Filtro	Common components
13	Clamp / Fascetta	Common components

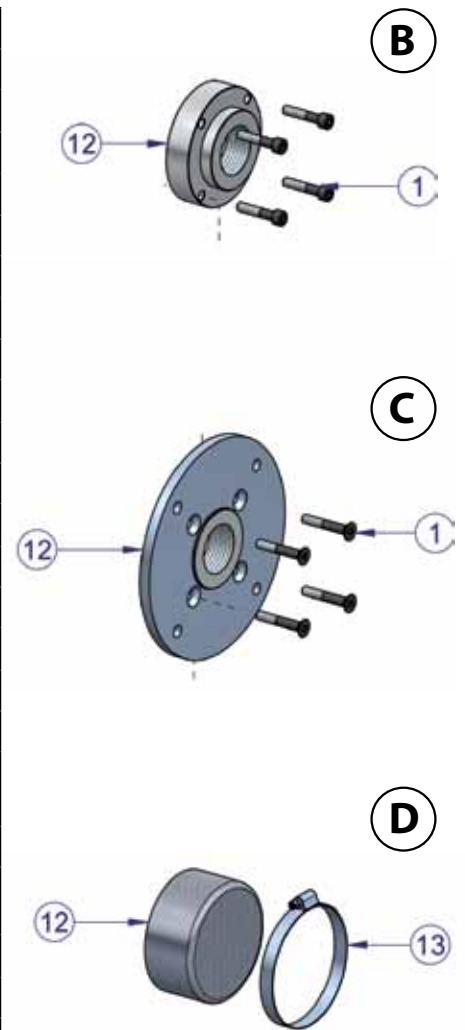

All data reported by catalogue can change without any notice. I dati presenti nel catalogo possono cambiare senza preavviso.

* Others materials available upon request. Altri materiali disponibili su richiesta.

INDUSTRIAL LUBE SERVICES

Power hydraulics (presses, machine tools, working machines rolling mill, dumping equipment, elevators, variable pitch propellers, hydraulic winches)
Power unit & mini power packs
Injection molding machinery (cooling & filtration systems)
Hydraulic governors
Cooling, heating, recycling
Driving and filtering
Process technology and chemistry

High pressure coolant fuel oil handling
Filtration applications
Chip conveyors
Turbine lubrication and oil jacking
Hydro power (turbines & compressor lubrication power)
Paper & Pulp (lubrication & filtration)
Gear box lube and filtration system (high viscosity lube, air emulsion, heavy duty applications)



POWER GENERATION

Lube oil service
Control oil service
Turbine shaft jacking service
Sealing oil service for gas turbine
Fuel unloading station
Fuel transfer
Fuel feeding
Burner operations service
Filtration & cooling



MARINE

Off-line filtration
Off-line filtration cart and trolleys
Filtration & oil transfer
Fuel service
Lube oil circulation service
Lubricating liquids (machines, turbines, gear sets, motors)



WIND MILLS

Cooling systems
Hydraulic pitch control and yaw control
Forced lubrication systems



OIL & GAS

Oil filtration & cooling , oil and fuel oil lubrication
Oil rigs, refineries (transport, meter and mix), off-shore platform
Petrochemical industry, transfer service.



SMT pump - Dimensional drawings / Disegni dimensionali

SMT Pump



SMT Series / Serie SMT
Dry screw pump
Pompa per uso esterno

SMIT Pump



SMIT Series / Serie SMIT
Submersible screw pump
Pompa per uso sommerso

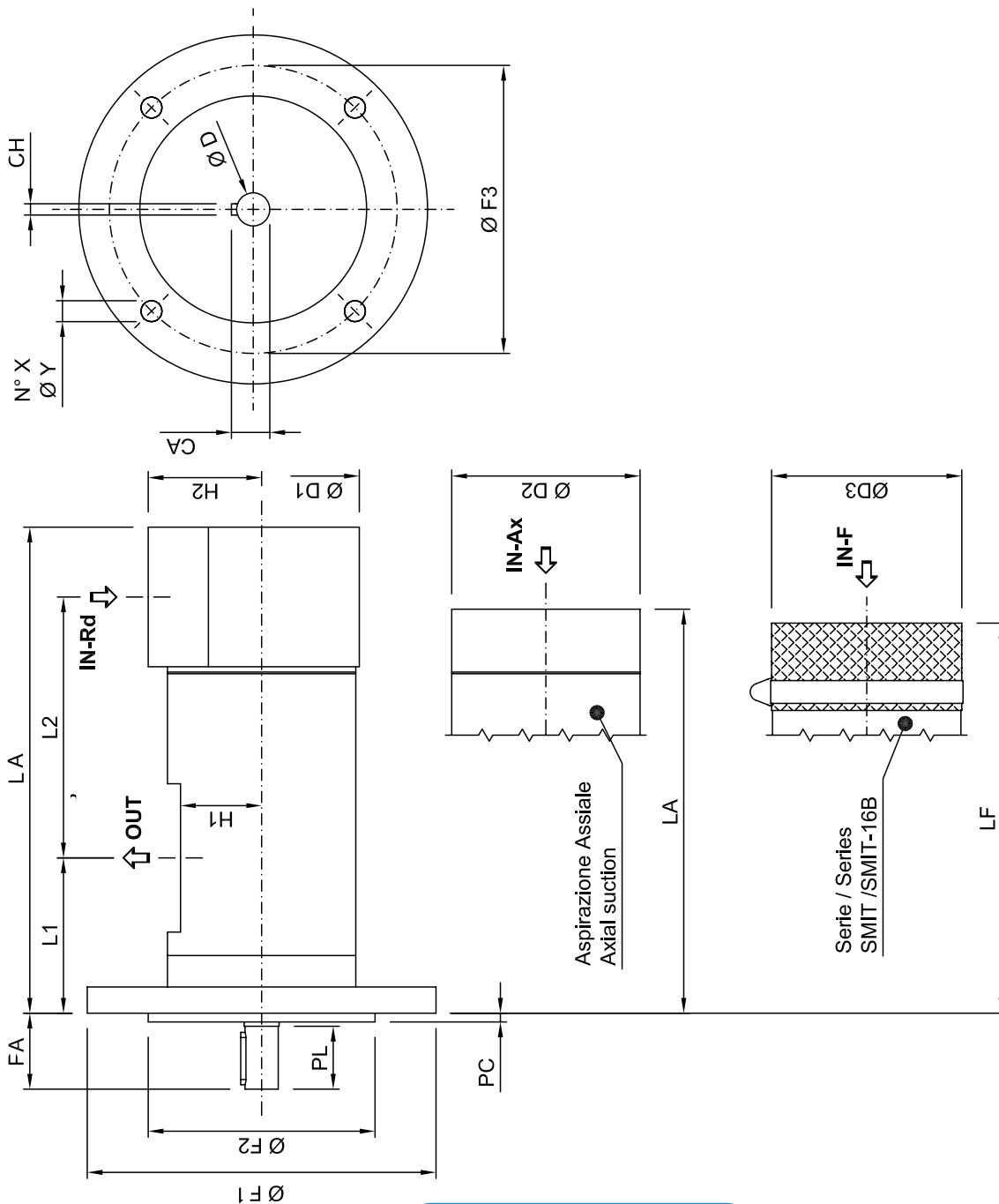

SMT pump - Dimensional drawings / Disegni dimensionali

SMT Series / Serie SMT Dry screw pump / Pompa per uso esterno		Flange Flangia				Shaft Albero				Suction Aspirazione				Discharge Mandata		Pump Pompa						
		ØF2	ØY	ØF3	ØF1	PL	ØD	CA	CH	IN-Rd	IN-Ax	H2	OUT	H1	PA	ØD2	L1	L2	LA	Kg	ØD3	LF
GR20 SMT 8L-12L-15L-20L-23L	80.0	11.0	103.0	125.0	30.0	14.0	16.0	5.0	1/2" BSPP	1/2" BSPP	26.0	1/2" BSPP	25.0	37.0	59.0	53.0	118.5	174.0	1.5	60.0	173.0	
GR25 SMT 25L-30L	80.0	11.0	103.0	125.0	36.0	19.0	21.5	6.0	3/4" BSPP	3/4" BSPP	27.0	1/2" BSPP	27.5	42.0	65.0	72.5	171.0	262.0	4	66.0	242.5	
GR32 SMT 35L-45L-55L-75L	100.0	11.0	125.0	150.0	35.0	19.0	21.5	6.0	1" 1/4 SAE -3000	1" 1/4 SAE -3000	55.0	1" SAE -3000	41.0	41.0	94.0	69.0	192.0	248.0	6.5	95.0	239.0	
GR40 SMT 100L-125L-150L	125.0	14.0	160.0	188.0	34.0	19.0	21.5	6.0	1" 1/2 SAE -3000	1" 1/2 SAE -3000	65.0	1" 1/4 SAE -3000	46.5	39.5	108.0	84.5	224.5	302.0	10.8	109.0	294.0	
GR45 SMT 180L-210L	125.0	14.0	160.0	188.0	55.0	32.0	35.0	10.0	2" SAE -3000	2" BSPP	85.0	2" SAE -3000	51.5	64.5	122.5	89.0	248.0	330.0	15	123.5	312.0	
GR55 SMT 250L-300L-330L-380L	160.0	18.0	200.0	235.0	55.0	32.0	35.0	10.0	2" 1/2 SAE -3000	2" 1/2 BSPP	95.0	2" 1/2 SAE -3000	55.0	61.5	142.5	100.5	297.0	385.5	23.5	143.5	395.5	
GR60 SMT 440L-500L	160.0	18.0	200.0	235.0	55.0	32.0	35.0	10.0	3" SAE -3000	3" BSPP	105.0	3" SAE -3000	63.0	65.5	155.0	101.0	342.0	423.5	30	154.0	430.5	
GR70 SMT 600L-660L-800L	200.0	22.0	250.0	300.0	55.0	32.0	35.0	10.0	3" 1/2 SAE -3000	3" 1/2 BSPP	110.0	3" SAE -3000	73.0	60.5	180.0	115.5	422.0	529.5	44	179.0	543.5	
GR80 SMT 1.000L-1.200L	200.0	22.0	250.0	300.0	60.0	38.0	41.0	10.0	4" SAE -3000	4" BSPP	125.0	3" SAE -3000	83.0	75.0	210.0	150.0	470.5	644.0	59	204.0	628.0	
GR90 SMT 1.220L	200.0	22.0	250.0	300.0	60.0	38.0	41.0	10.0	4" SAE -3000	4" BSPP	125.0	3" SAE -3000	83.0	75.0	210.0	150.0	470.5	644.0	61	204.0	628.0	

All data reported by catalogue can change without any notice. I dati presenti nel catalogo possono cambiare senza preavviso.

SMT AC pumps - Dimensional drawings / Disegni dimensionali

SMT AC Pump



SMT AC Series / Serie SMT AC
Dry screw pump
Pompa per uso esterno

SMIT AC Pump



SMIT AC Series / Serie SMIT AC
Submersible screw pump
Pompa per uso sommerso

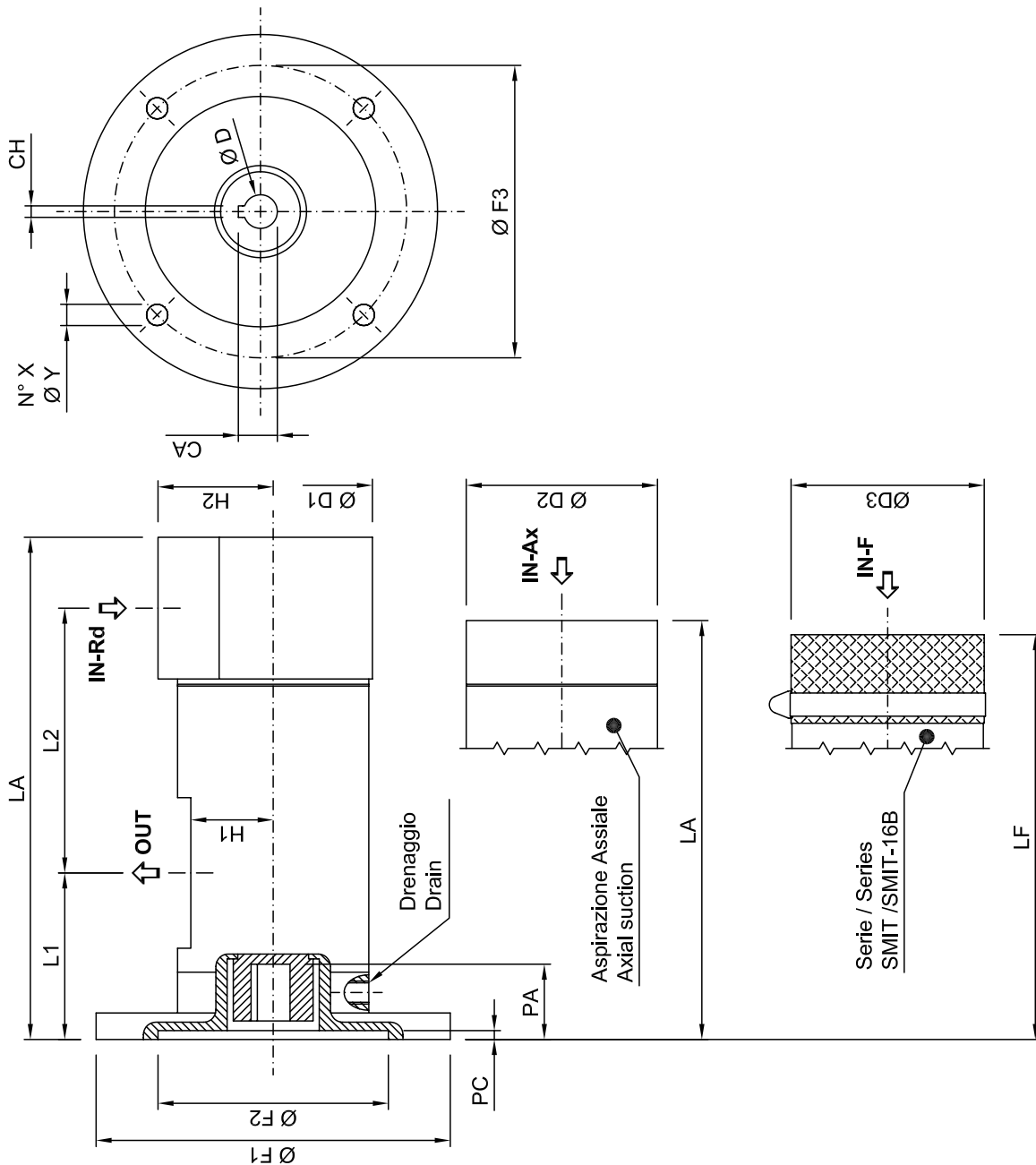

SMT AC pumps - Dimensional drawings / Disegni dimensionali

SMT AC Series / Serie SMT AC		Dry screw pump / Pompa per uso esterno										Submersible screw pump / Pompa per uso sommerso									
		Flange/Flangia			Shaft / Albero			Suction / Aspirazione				Discharge / Mandata			Pump / Pompa					Pump / Pompa	
Type/Tipologia	ØF2	ØY	ØF3	ØF1	ØD	CA	CH	IN-Rd	IN-AX	H2	OUT	H1	PA	ØD2	L1	L2	LA	Kg	ØD3	LF	
GR20 SMT AC11 B5 8-12-15-20-23	95.0	9.0	115.0	140.0	11.0	12.8	4.2	1/2"BSPP	1/2"BSPP	26.0	1/2"BSPP	25.0	25.0	59.0	57.0	118.5	178.0	1.5	60.0	177.0	
GR20 SMT AC14 B5 8-12-15-20-23	110.0	9.5	130.0	160.0	14.0	16.1	5.2	1/2"BSPP	1/2"BSPP	26.0	1/2"BSPP	25.0	33.5	59.0	56.0	118.5	177.0	1.5	60.0	176.0	
GR20 SMT AC19 B5 8-12-15-20-23	130.0	11.0	165.0	200.0	19.0	21.7	6.5	1/2"BSPP	1/2"BSPP	26.0	1/2"BSPP	25.0	42.0	59.0	75.0	118.5	196.0	1.5	60.0	195.0	
GR25 SMT AC14 B5 25-30	110.0	9.5	130.0	160.0	14.0	16.2	5.2	3/4"BSPP	3/4"BSPP	27.0	1/2"BSPP	27.5	32.5	65.0	73.5	171.0	263.0	2.7	66.0	243.5	
GR25 SMT AC19 B5 25-30	130.0	10.5	165.0	200.0	19.0	21.9	6.5	3/4"BSPP	3/4"BSPP	27.0	1/2"BSPP	27.5	42.5	65.0	76.5	171.0	266.0	2.7	66.0	246.5	
GR32 SMT AC19 B5 35-45-55-75	130.0	12.0	165.0	200.0	19.0	21.9	6.5	1"1/4 SAE-3000	1"1/4 BSPP	55.0	1"SAE-3000	41.0	43.7	94.0	92.7	192.0	271.7	4.4	95.0	262.7	
GR32 SMT AC24 B5 35-45-55-75	130.0	12.0	165.0	200.0	24.0	27.3	8.5	1"1/4 SAE-3000	1"1/4 BSPP	55.0	1"SAE-3000	41.0	52.7	94.0	92.7	192.0	271.7	4.4	95.0	262.7	
GR40 SMT AC19 B5 100-125-150	130.0	12.0	165.0	200.0	19.0	22.0	6.5	1"1/2 SAE-3000	1"1/2 BSPP	65.0	1"1/4 SAE-3000	46.5	42.5	108.0	109.5	224.5	327.0	7	109.0	319.0	
GR40 SMT AC24 B5 100-125-150	130.0	12.0	165.0	200.0	24.0	27.5	8.5	1"1/2 SAE-3000	1"1/2 BSPP	65.0	1"1/4 SAE-3000	46.5	52.5	108.0	109.5	224.5	327.0	7	109.0	319.0	
GR40 SMT AC28 B5 100-125-150	180.0	14.0	215.0	250.0	28.0	31.5	8.5	1"1/2 SAE-3000	1"1/2 BSPP	65.0	1"1/4 SAE-3000	46.5	64.0	108.0	120.0	224.5	337.5	7	109.0	329.5	
GR45 SMT AC28 B5 180-210	180.0	14.0	215.0	250.0	28.0	31.5	8.5	2"SAE-3000	2"BSPP	85.0	1"1/2 SAE-3000	51.5	63.5	122.5	120.0	248.0	361.0	7	123.5	343.0	
GR45 SMT AC38 B5 180-210	230.0	15.0	265.0	300.0	38.0	42.0	10.5	2"SAE-3000	2"BSPP	85.0	1"1/2 SAE-3000	51.5	81.0	122.5	133.5	248.0	374.5	7	123.5	356.5	
GR55 SMT AC28 B5 250-300-330-380	180.0	14.0	215.0	250.0	28.0	31.5	8.5	2"1/2 SAE-3000	2"1/2 BSPP	95.0	2"SAE-3000	55.0	62.5	142.5	125.5	297.0	410.5	15.5	143.5	420.5	
GR55 SMT AC38 B5 250-300-330-380	230.0	15.0	265.0	300.0	38.0	42.0	10.5	2"1/2 SAE-3000	2"1/2 BSPP	95.0	2"SAE-3000	55.0	82.5	142.5	145.5	297.0	410.5	15.5	143.5	440.5	
GR60 SMT AC28 B5 440-500	180.0	14.0	215.0	250.0	28.0	31.5	8.5	3"SAE-3000	3"BSPP	105.0	2"1/2 SAE-3000	63.0	65.0	155.0	126.0	342.0	448.5	25	154.0	455.5	
GR60 SMT AC38 B5 440-500	230.0	14.5	265.0	300.0	38.0	41.8	10.5	3"SAE-3000	3"BSPP	105.0	2"1/2 SAE-3000	63.0	83.0	155.0	146.0	342.0	468.5	25	154.0	475.5	
GR70 SMT AC28 B5 600-660-800	180.0	14.0	215.0	250.0	28.0	31.5	8.5	3"1/2 SAE-3000	3"1/2 BSPP	110.0	3"SAE-3000	73.0	63.1	180.0	139.3	422.0	553.3	30	179.0	567.3	
GR70 SMT AC38 B5 600-660-800	230.0	14.5	265.0	300.0	38.0	41.8	10.5	3"1/2 SAE-3000	3"1/2 BSPP	110.0	3"SAE-3000	73.0	87.3	180.0	160.5	422.0	574.5	30	179.0	588.5	

All data reported by catalogue can change without any notice. I dati presenti nel catalogo possono cambiare senza preavviso.

Suction and drain configuration / Configurazioni aspiraz. e drenaggio

Suction and drain hole configuration available as per table below (orientations relative to pressure port).
 Configurazioni di porte di aspirazione, mandata e drenaggio. Vedi tabella sotto.

Standard configuration / Configurazioni standard

Standard configuration: T1 – D2

Configurazione standard: T1 – D2

Standard configuration for pumps WITH RP VALVE: T4 – D2

Configurazione standard per pompa CON VALVOLA RP: T4 – D2

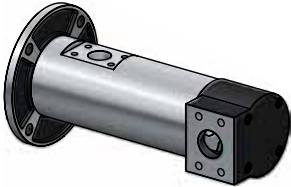
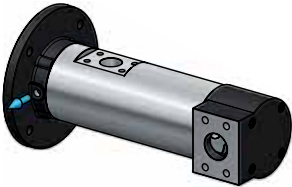
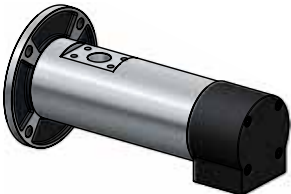
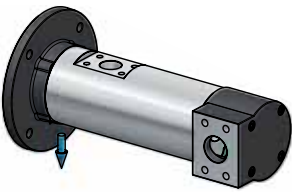
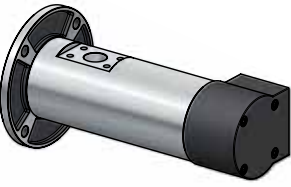
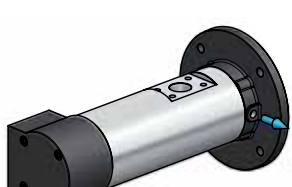
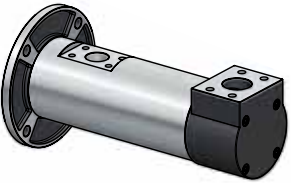
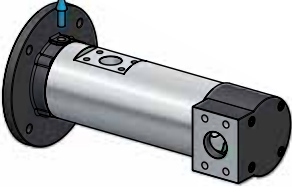
SUCTION CONFIGURATION CODES / CODICI CONFIGURAZIONE ASPIRAZIONE		DRAIN CONFIGURATION CODES / CODICI CONFIGURAZIONE DRENAGGIO	
	T1		D1
	T2		D2
	T3		D3
	T4		D4

Settima recommends that in case of request of pump with RP valve (external variable regulation valve), it is necessary to choose very carefully the suction and drain configuration. Once the external valve is built on the pump it will be not possible any change of both configurations.

Settima raccomanda di scegliere attentamente la configurazione delle porte nel caso di pompa con valvola RP (valvola regolazione variabile esterna). La valvola RP impedisce di modificare l'orientamento delle porte una volta installata sulla pompa.



Motor pump selection / Selezione motore

Please check the table below to select the right motor.

Controllare la tabella per selezionare il motore adatto.

Size	Motor form <i>Forma motore</i>	56 AC9	63 AC11	71 AC14	80 AC19	90 AC24	100 AC28	112 AC28	132 AC38
GR 20	B14	✓	✓	✓	✓				
	B5		✓	✓	✓				
GR 25	B14			✓	✓				
	B5			✓	✓				
GR 32	B14				✓	✓			
	B5				✓	✓			
GR40	B14				✓	✓	✓	✓	
	B5				✓	✓	✓	✓	
GR45	B5						✓	✓	✓
GR55	B5						✓	✓	✓
GR60	B5						✓	✓	✓
GR70	B5						✓	✓	✓

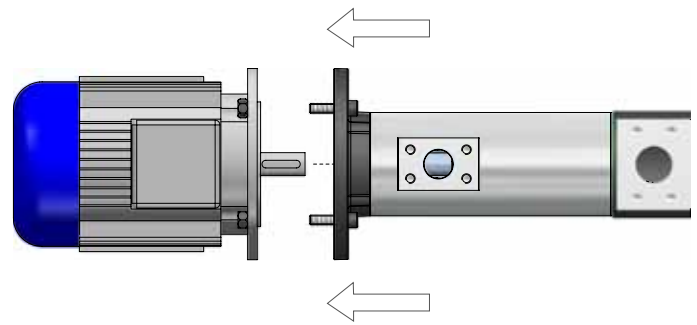
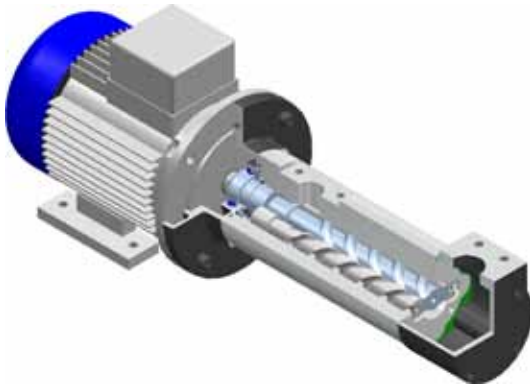

IEC standard motor

Ordering code table / Tabella codici di ordinazione

Pump type Tipo	Pump model Modello	Nominal flow Portata nominale	High viscosity flag Alta viscosità	Shaft type Tipo albero	Hollow shaft flange Flangia albero cavo	Pump body** Corpo pompa**	Seals polymer (shaft, O-ring) Polimero guarnizioni (albero, anello di tenuta)	Screw treatment Trattamento viti	Seal type Tipo di tenuta	Suction configuration code Codice porta aspirazione	Drain configuration codes (hollow shaft only) Codici drenaggio (solo AC)	Internal pressure relief valve Valvola interna di sicurezza	Suction flange Flangia d'aspirazione	Rotation Rotazione	Bearing type Tipo cuscinetto	
GR20		8L, 12L, 15L, 20L, 23L		Standard normal shaft & flange type		Standard aluminium Alluminio (none)		Standard steel main screw	Standard Lip seal (none)	Standard T1 (none)		Standard No security valve Nessuna valvola (none)	Standard radial radiale (none)	Standard Clockwise destra (none)	Standard (none)	
GR25		25L, 30L						cast iron idler screws								
GR32		35L, 45L, 55L, 75L						vite centrale in acciaio								
GR40		100L, 125L, 150L	Standard up to fino a 100 cSt (none)	albero maschio e flangia (none)		Optional GD cast iron ghisa	Standard NBR (none)	viti laterali in ghisa (none)	Optional TM*** mechanical seal for oil	Standard D2 (none)		Optional RF1 5 bar security sicurezza 5 bar				
GR45	SMT dry esterna	180L, 210L		B5 B14 (only hollow shaft) (solo albero cavo)		GZ cast iron with internal coating ghisa con rivestimento interno	Optional V FKM	core hardened steel screws (available only with mechanical seal)	TMK mechanical seal for water and glycole an coolant fluids	Optional D1		Optional AXS axial SAE assiale SAE		Optional CS encapsulated ball bearing cuscinetto schermato		
GR55	SMT submersible sommersa	250L, 300L, 330L, 380L		Optional hollow shaft type* Albero cavo* AC9 AC11 AC14 AC19 AC24 AC28 AC38		A carbon steel acciaio	Optional E EPDM	viti in acciaio temprato (solo con TM)	TMZ mechanical seal for fuel oil	Optional T2 T3 T4		Optional AX axial BSPP assiale BSPP	Optional SX counter clockwise sinistra			
GR60		440L, 500L	Optional SN from da 100 cSt					surface treated screws viti trattate superficialmente	FGM magnetic sealless pump			Optional AL tank-top flange tappa d'aspirazione sopra serbatoio				
GR70		600L, 660L, 800L				AZ carbon steel with internal coating acciaio con rivestimento interno						RP**** variable regulation valve valvola esterna a regolazione variabile				
GR80		1.000L, 1.200L														
GR90		1.220L														

* To request the right hollow shaft according to the pump model please check chapter "Motor pump selection". Per richiedere il giusto tipo di albero cavo in base al modello di pompa vedere il capitolo "Selezione motore".

** Please contact Settima for different available materials and treatments. Contattare Settima per differenti materiali e trattamenti disponibili.

*** Options HA and TM are not available for version SMT AC. Le opzioni HA e TM non sono disponibili per i modelli SMT AC.

**** RP valve not available for GR80 and GR90. Valvola RP non disponibile per GR80 e GR90.

***** RP valve is not available with options AX and AL. La valvola RP non è disponibile con le opzioni AX e AL.

Ordering code table / Tabella codici di ordinazione

Samples application summary / Esempi possibili per applicazioni

Fluid applications/ <i>Applicazioni fluidi</i>	High viscosity configuration- <i>Configurazione per elevate viscosità</i>	Body material <i>Materiale corpo</i>	Screw material <i>Materiale viti</i>	Seals <i>Tenute</i>	Bearing type <i>Tipo cuscinetto</i>
Diesel fuel, marine distillate fuel, marine residual fuel, low viscosity fuel oil <i>Diesel, distillati marini, residui marini, carburanti, fuel oil a bassa viscosità</i>	-	GD/GZ ¹	HA	TMZ	*
Heavy fuel oil transfer <i>Trasferimento di olio combustibile</i>	SN	GD	HD	TMZ	*
Lube services high viscosity – gearboxes air emulsion <i>Lubrificazione ad alta viscosità – emulsioni aria per ingranaggi</i>	SN	*	*	*/TM	*
Water glycole / <i>Emulsioni acqua-glicole</i>	-	GD/GZ ¹	HA	TMK	CS
Machine tools – coolant systems <i>Macchine utensili – sistemi lubrorefrigeranti</i>	-	GD	HA	TMK	CS

All data reported by catalogue can change without any notice. *I dati presenti nel catalogo possono cambiare senza preavviso.*

¹ Contact Settima for high pressure applications. *Contattare Settima per applicazioni ad alta pressione.*

*Standard configuration and material. *Configurazione e materiali standard.*

Example of codes normal shaft / Esempi di codici albero maschio:

GR45 SMT 210L GD HD TM

Example of codes for hollow shaft models / Esempi di codici per modelli ad albero cavo:

GR32 SMT 45L AC24/B5 GD V

Performances @ 1500 - GR 20-25

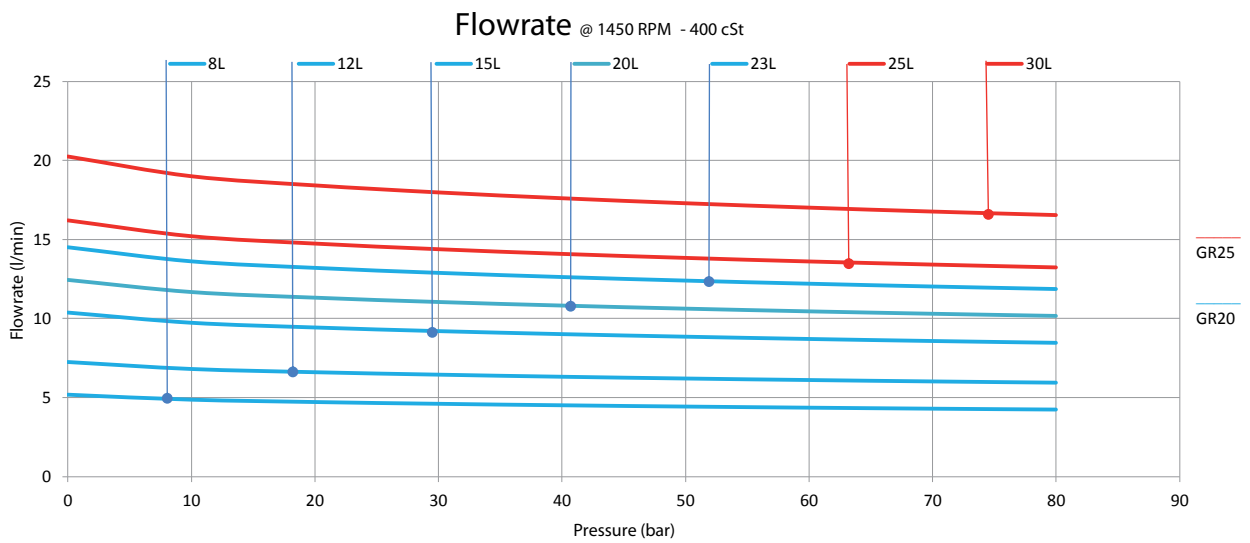
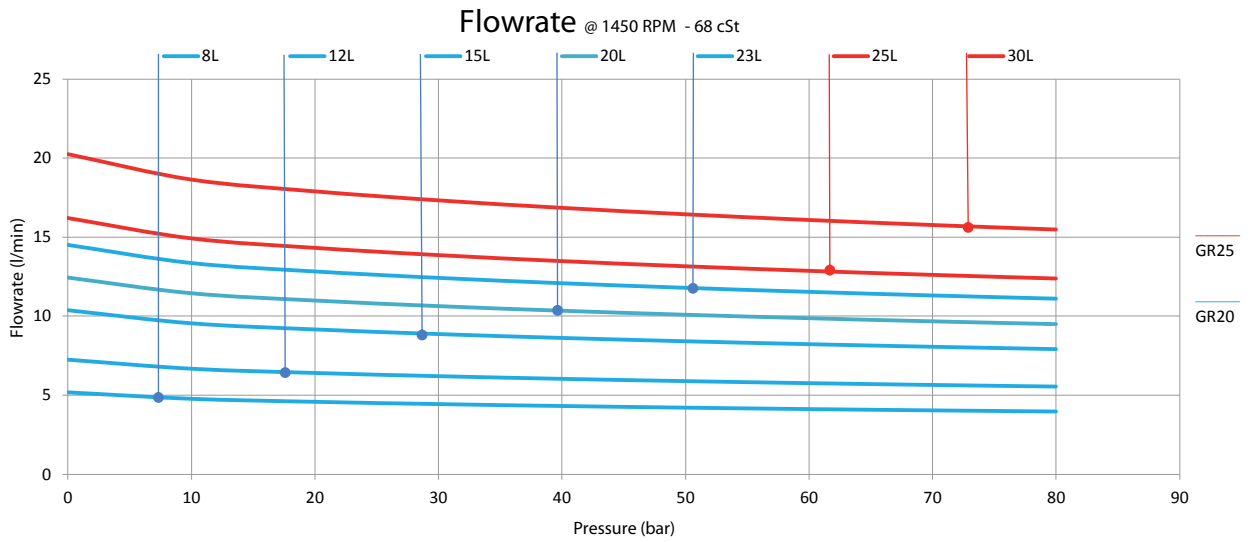
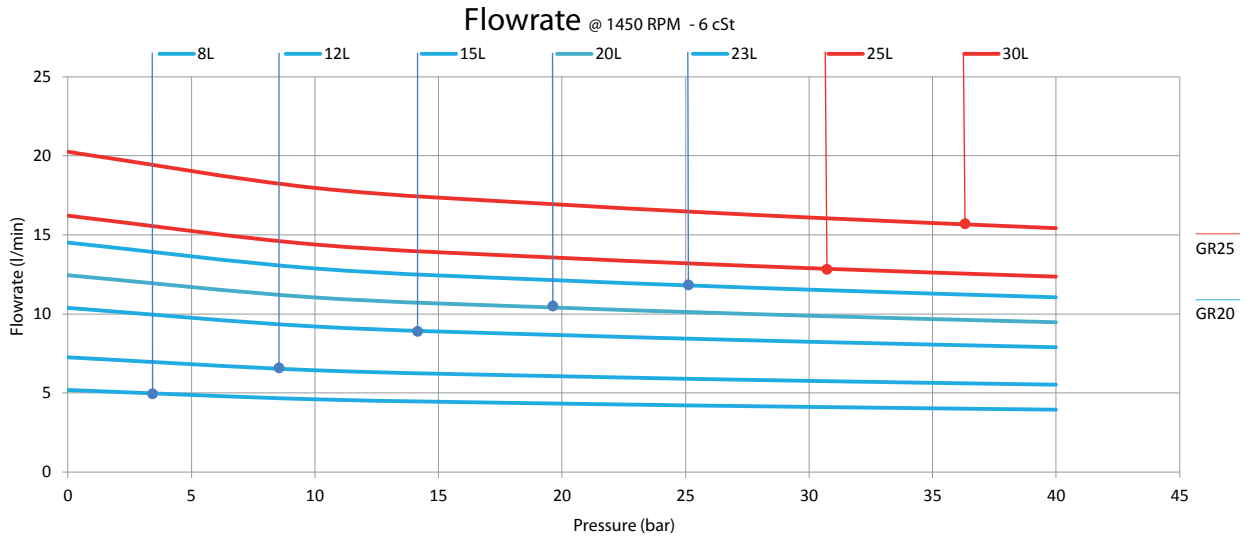

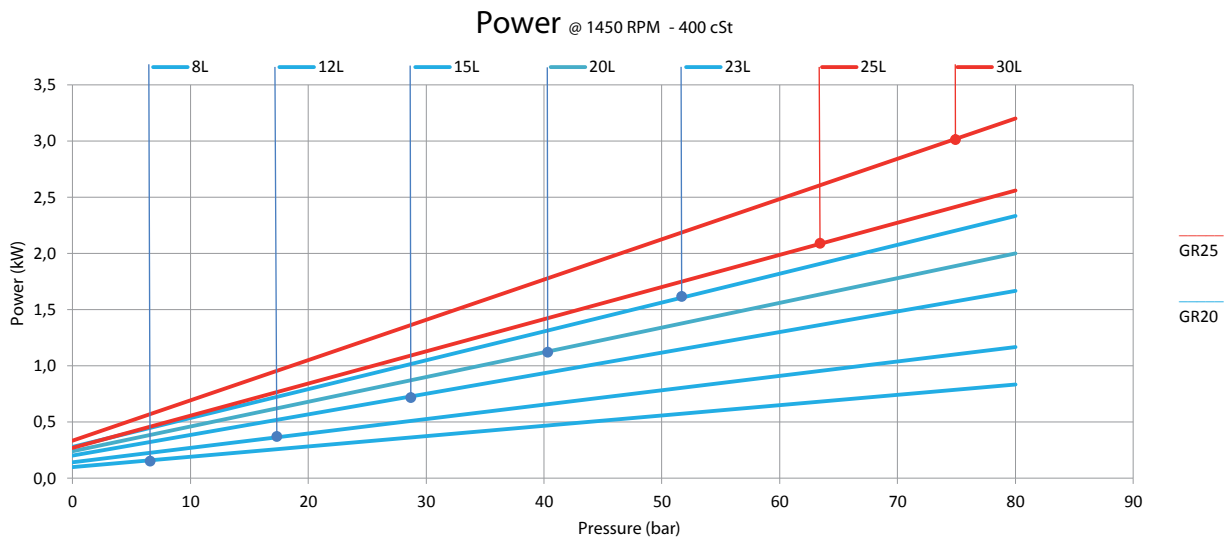
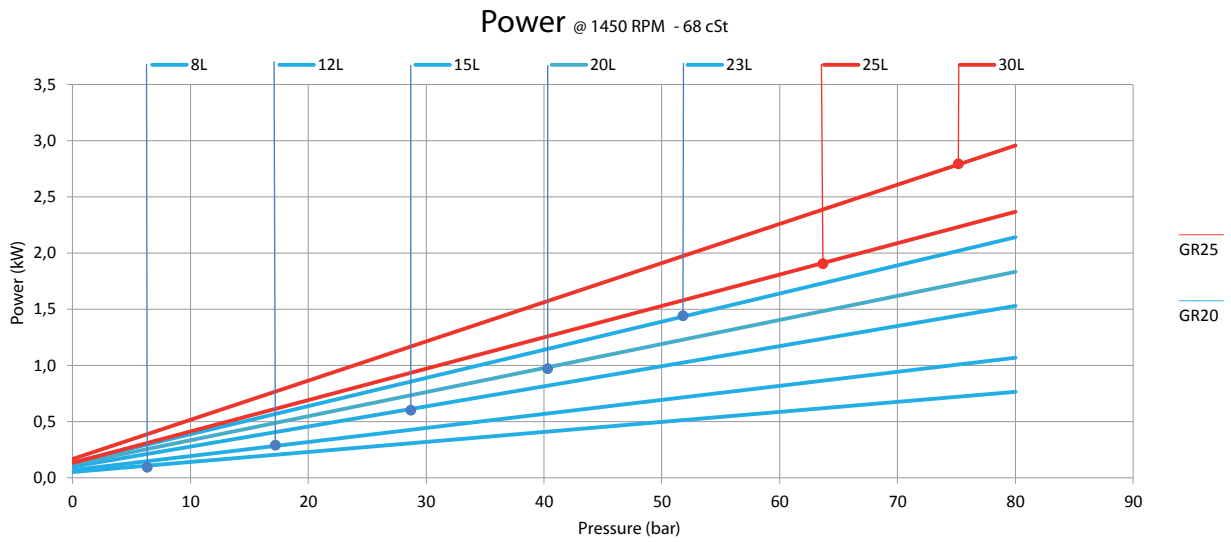
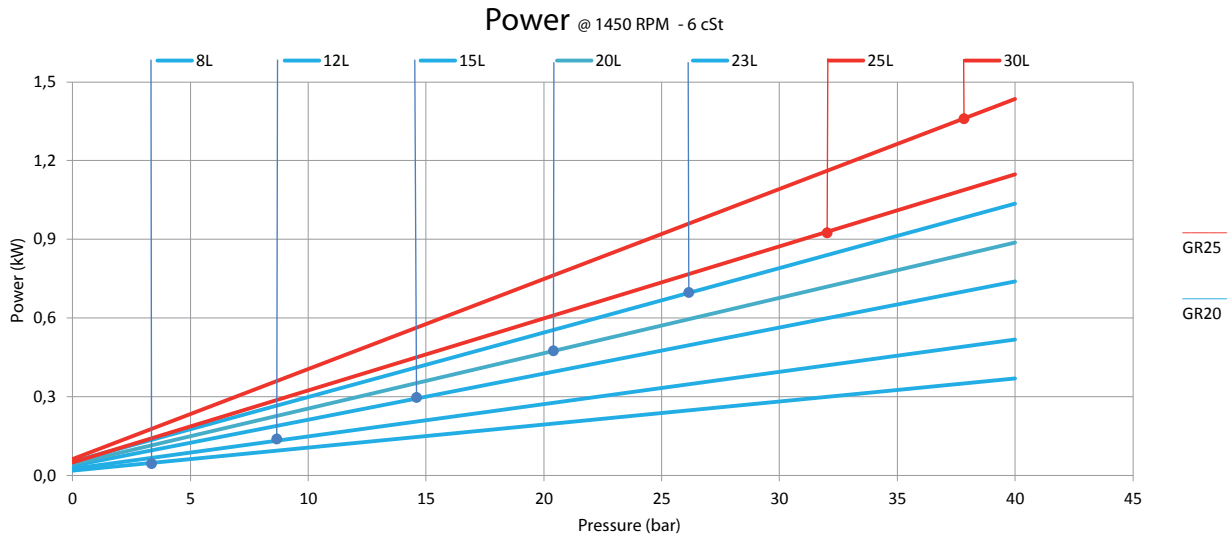

Performances @ 3000 - GR 20-25

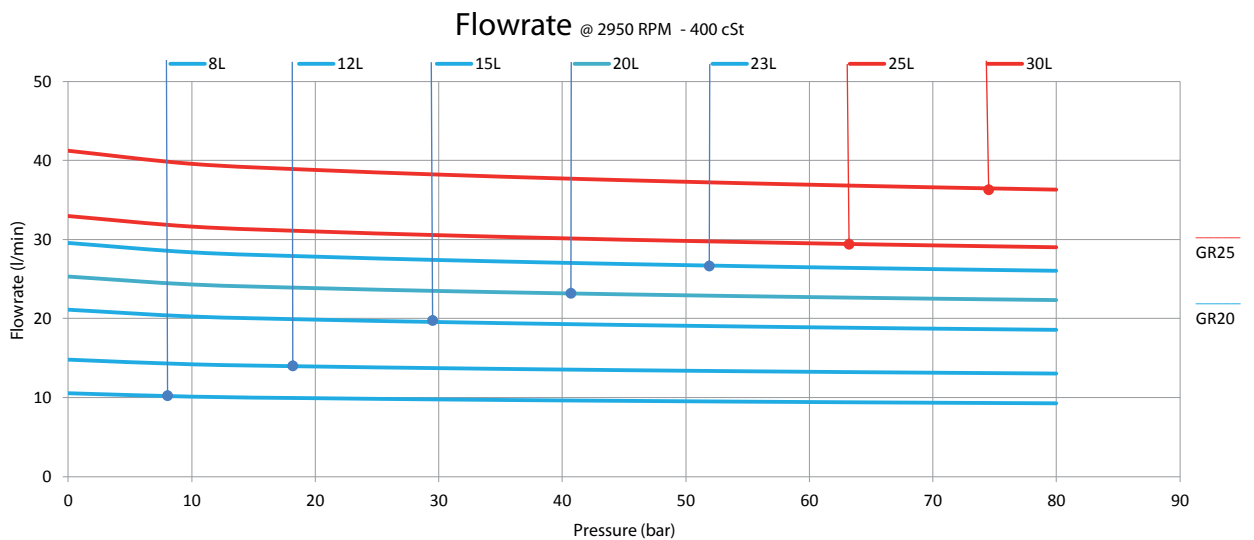
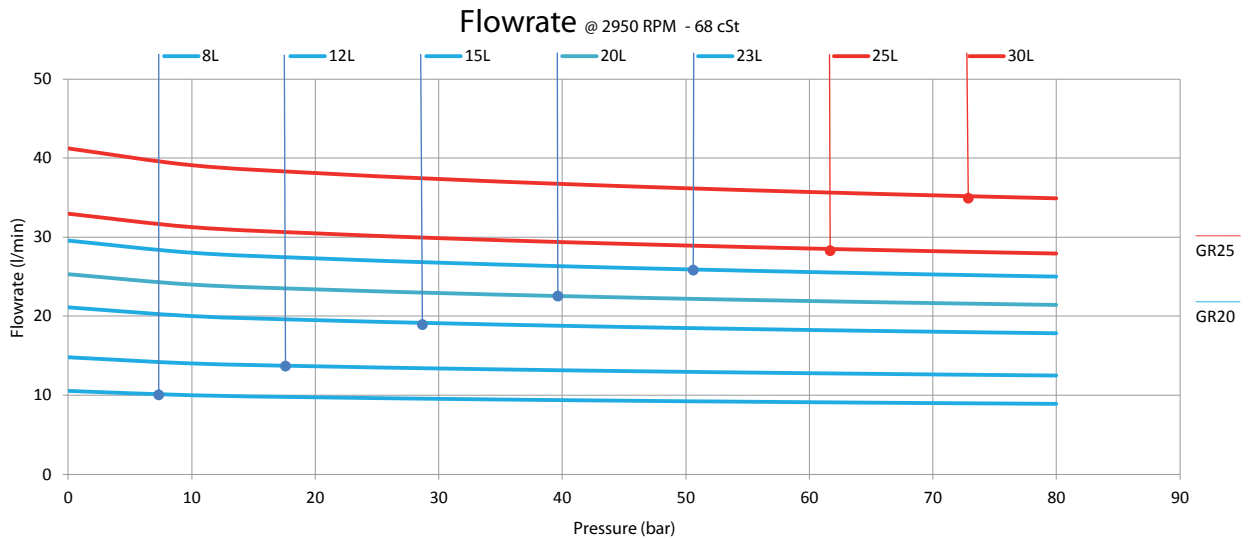
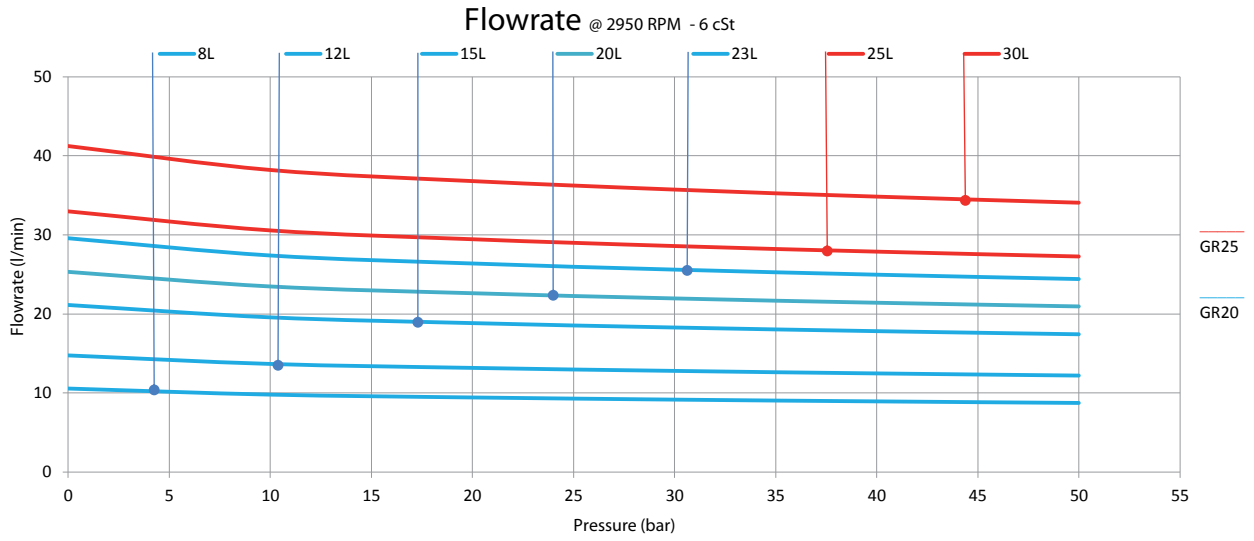

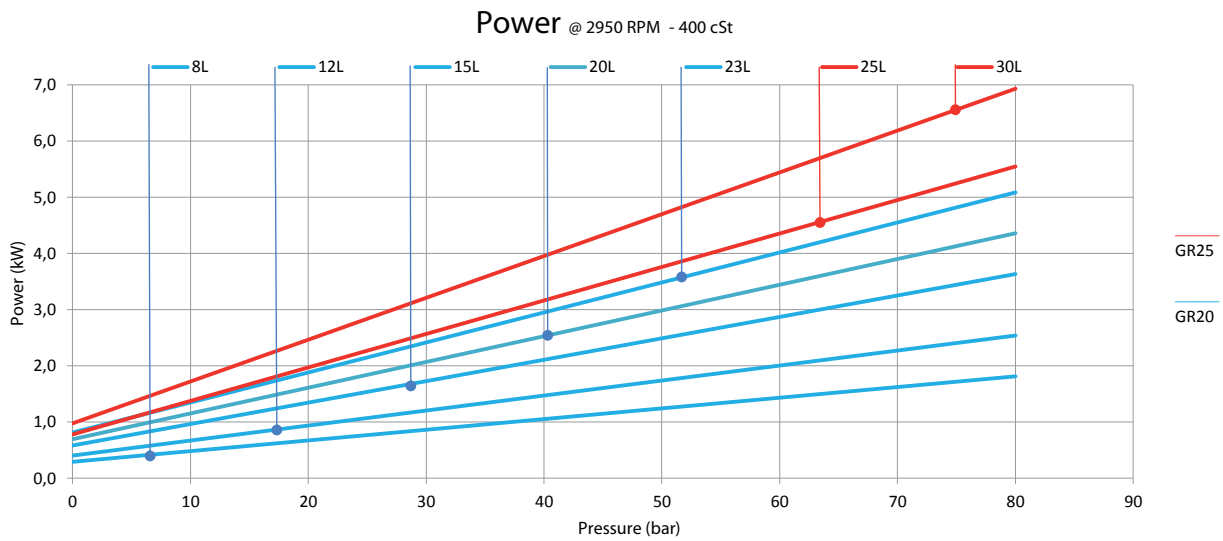
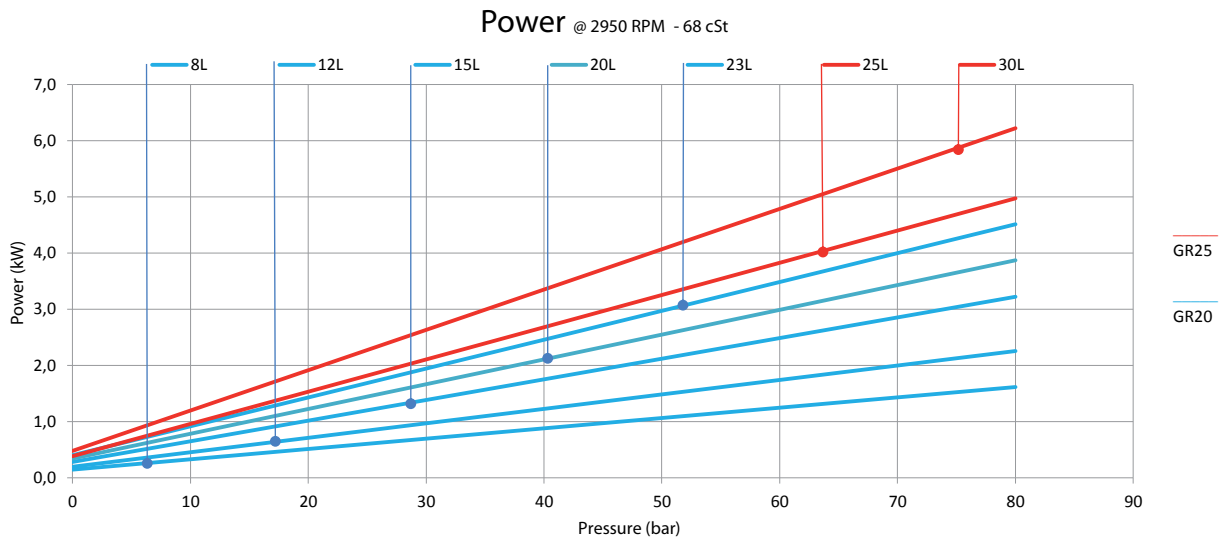
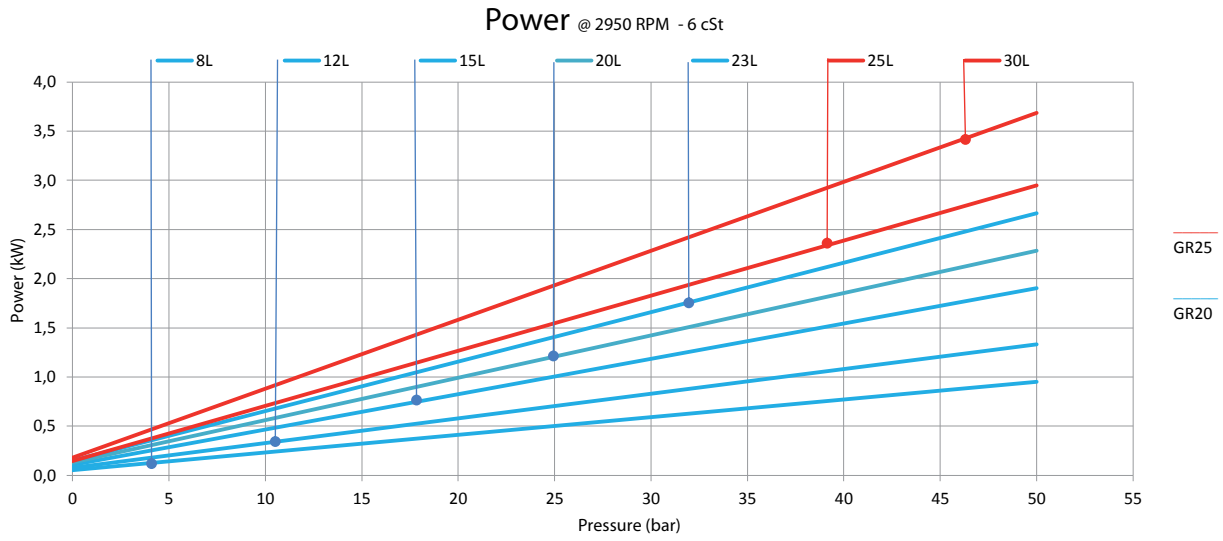

Performances @ 1500 - GR 32-40-45

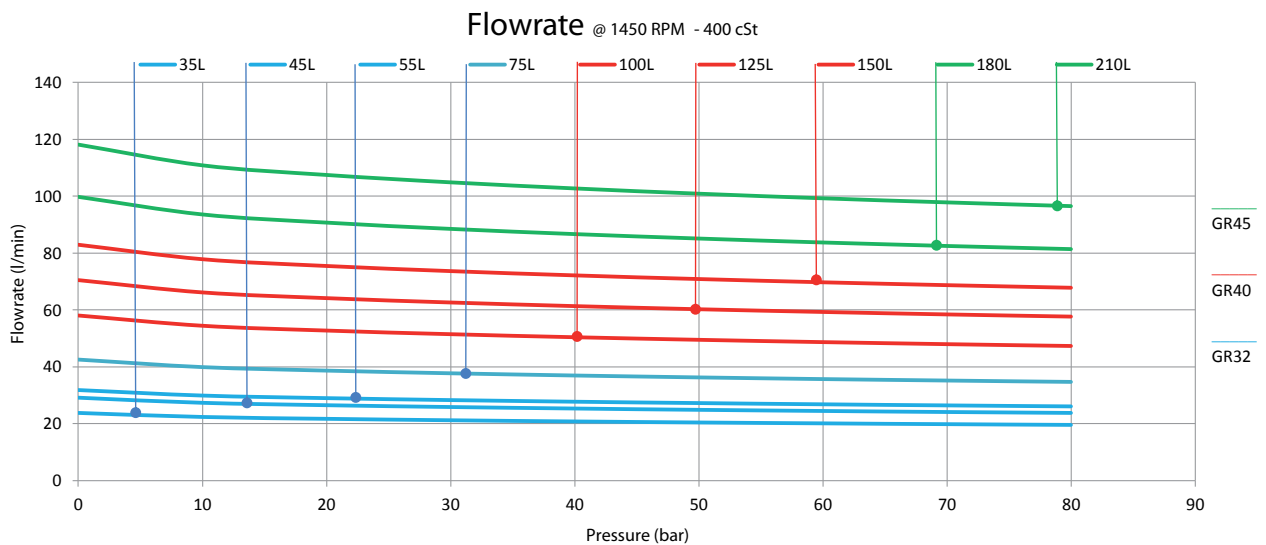
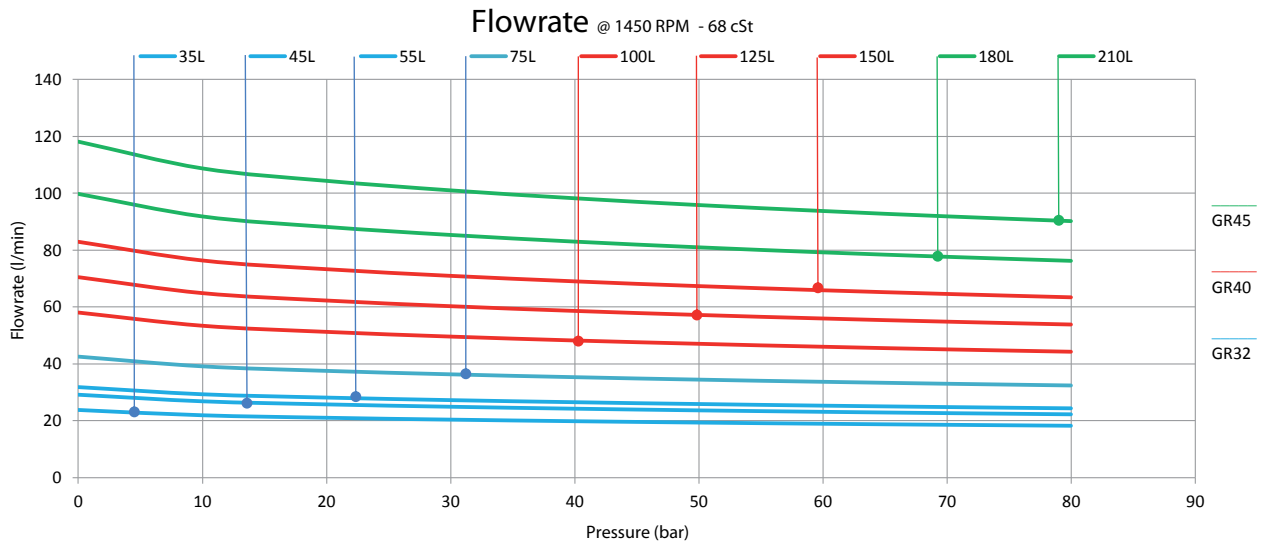
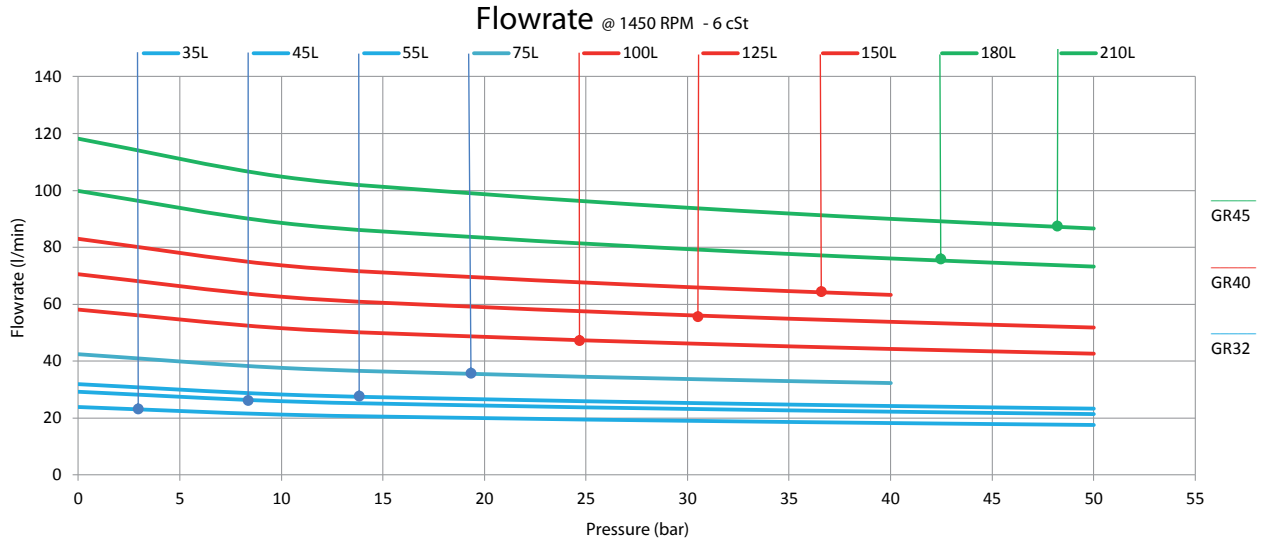

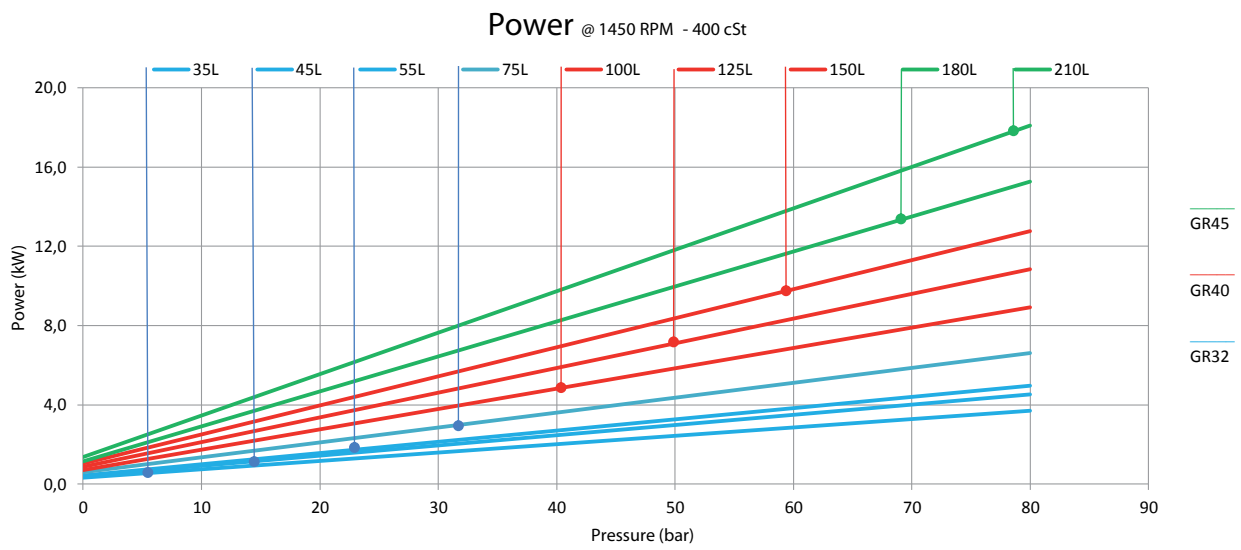
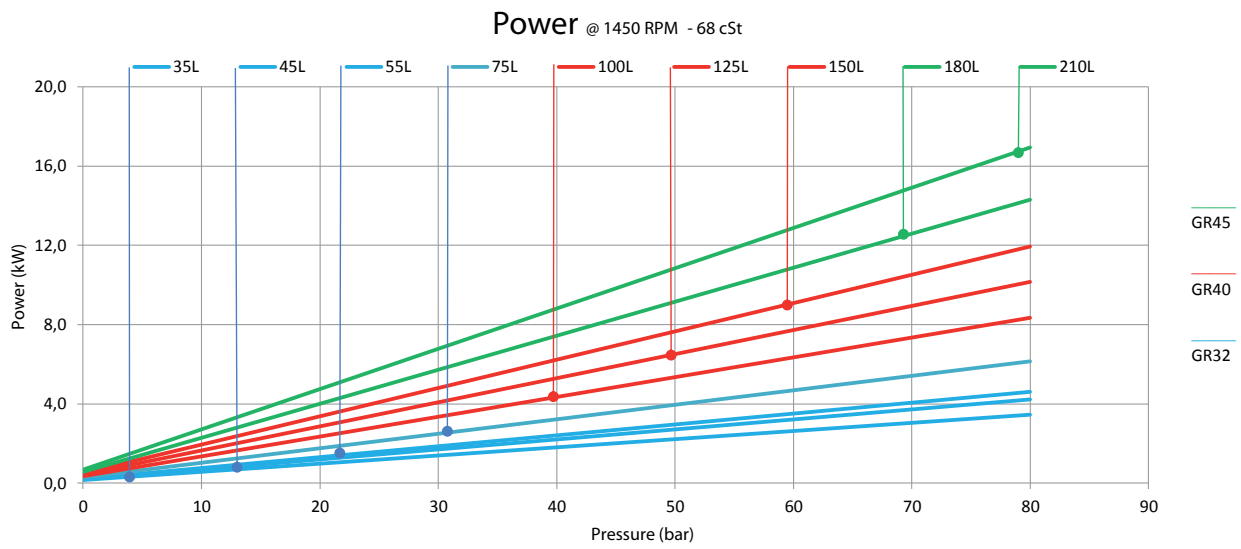
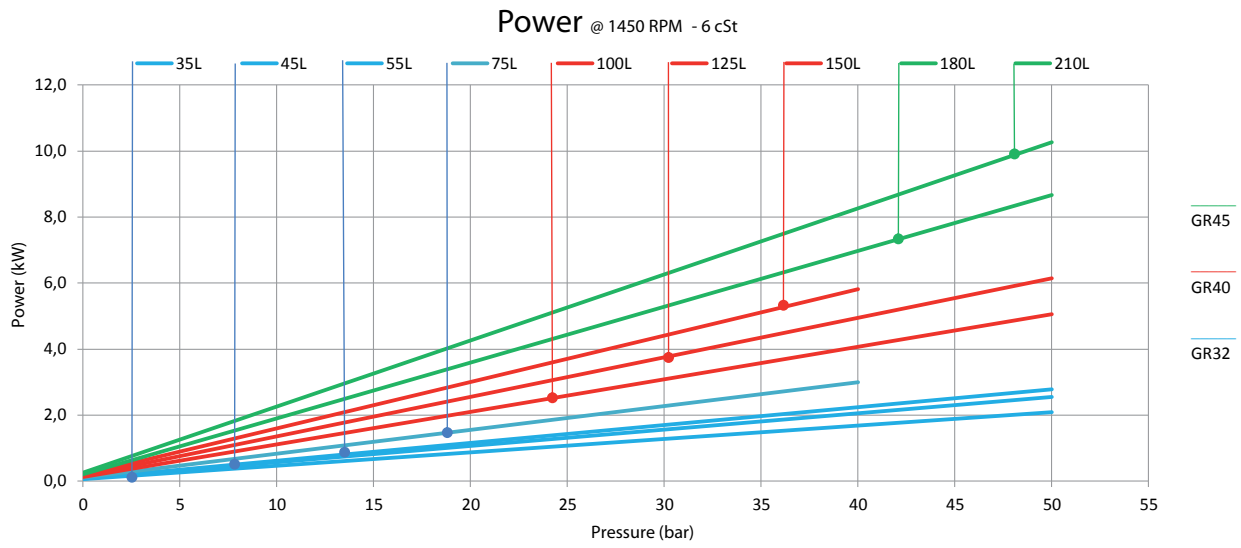

Performances @ 3000 - GR 32-40-45

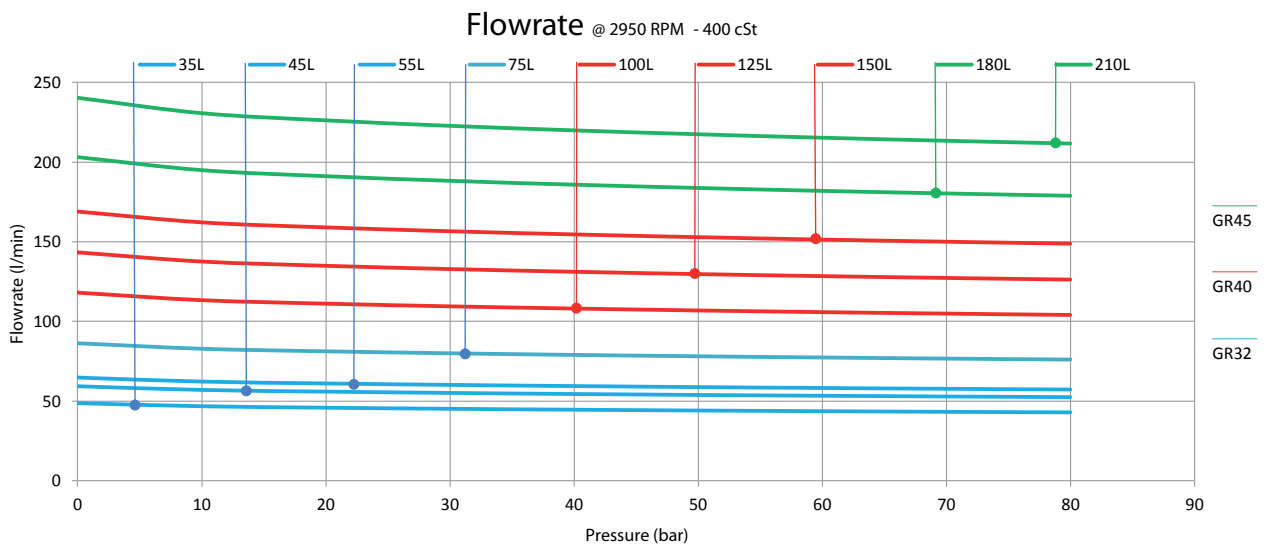
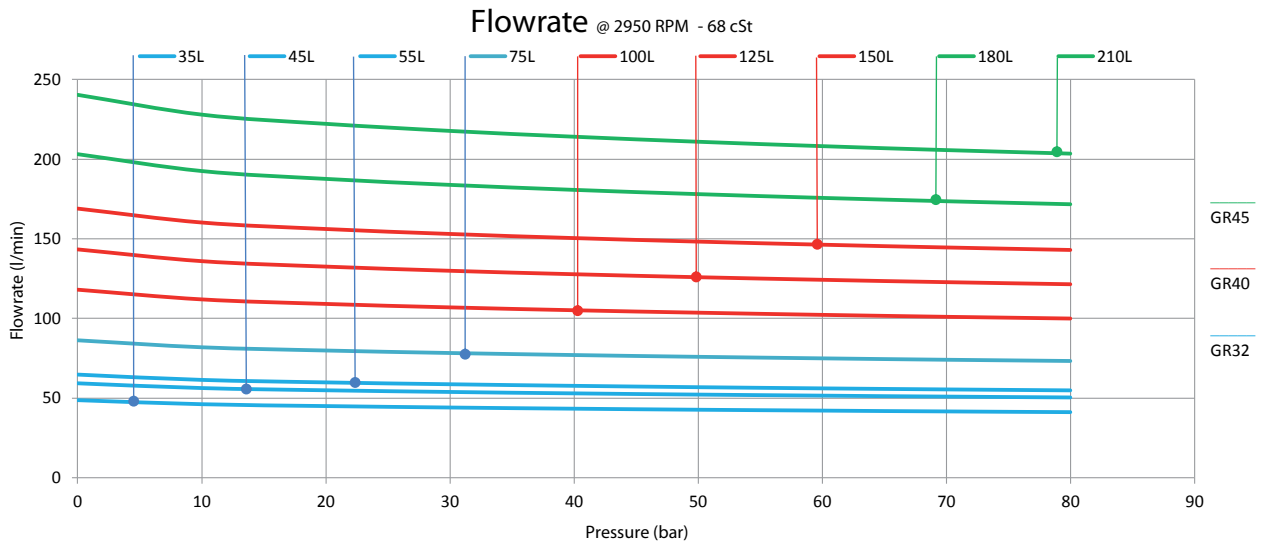
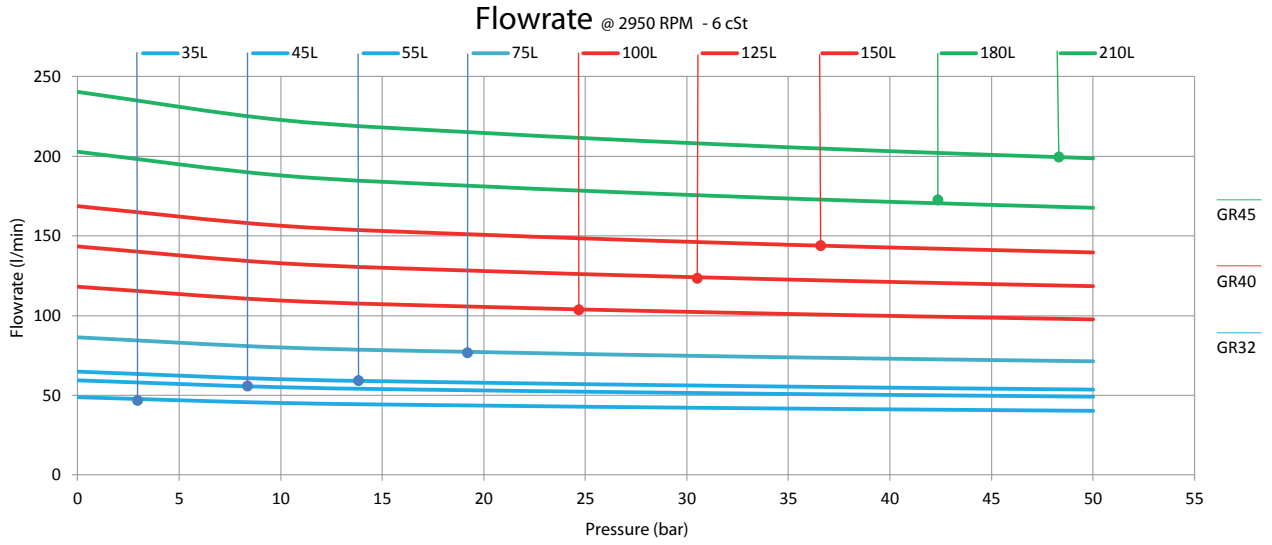

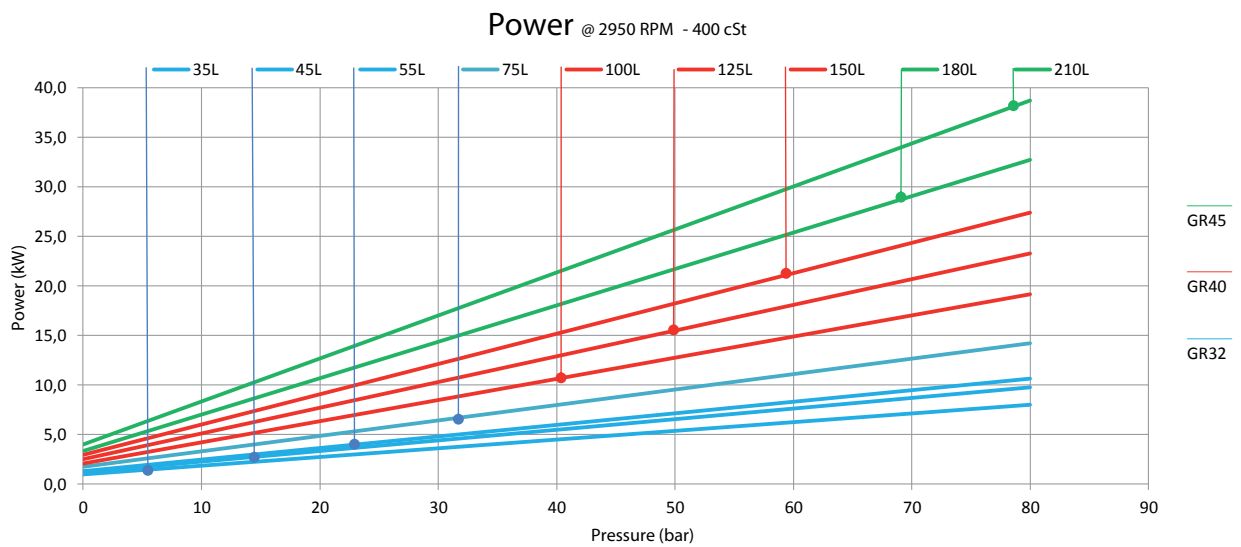
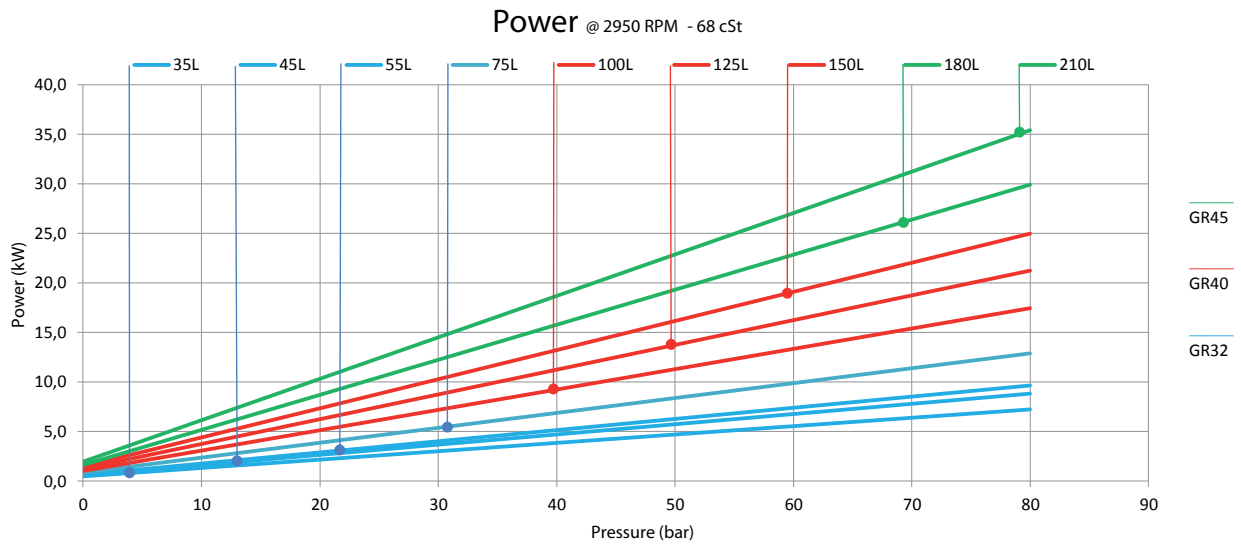
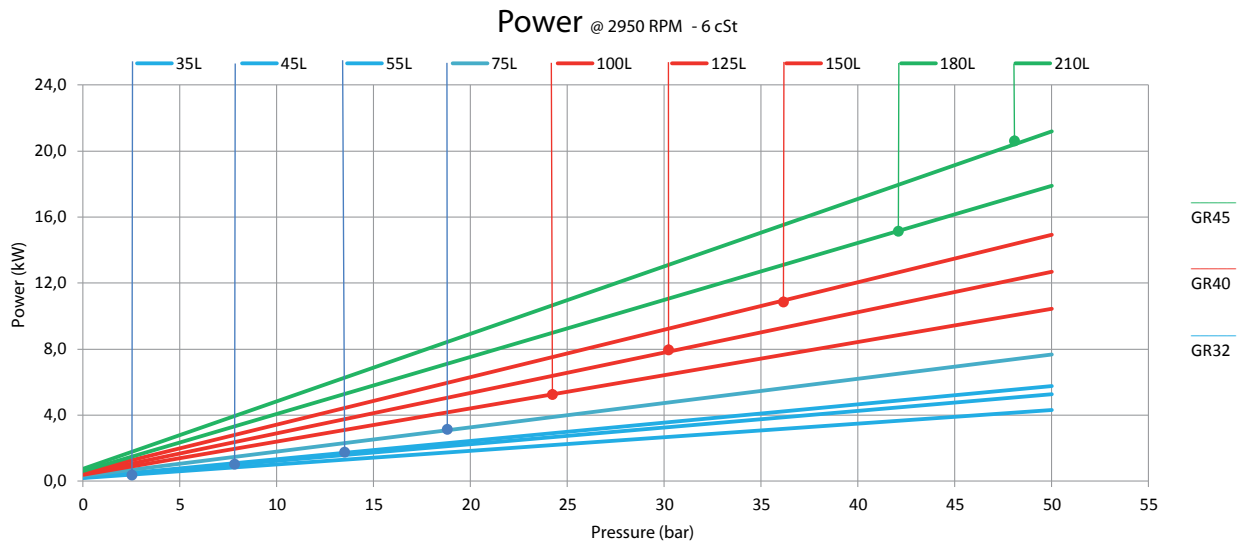

Performances @ 1500 - GR 55-60-70-80-90

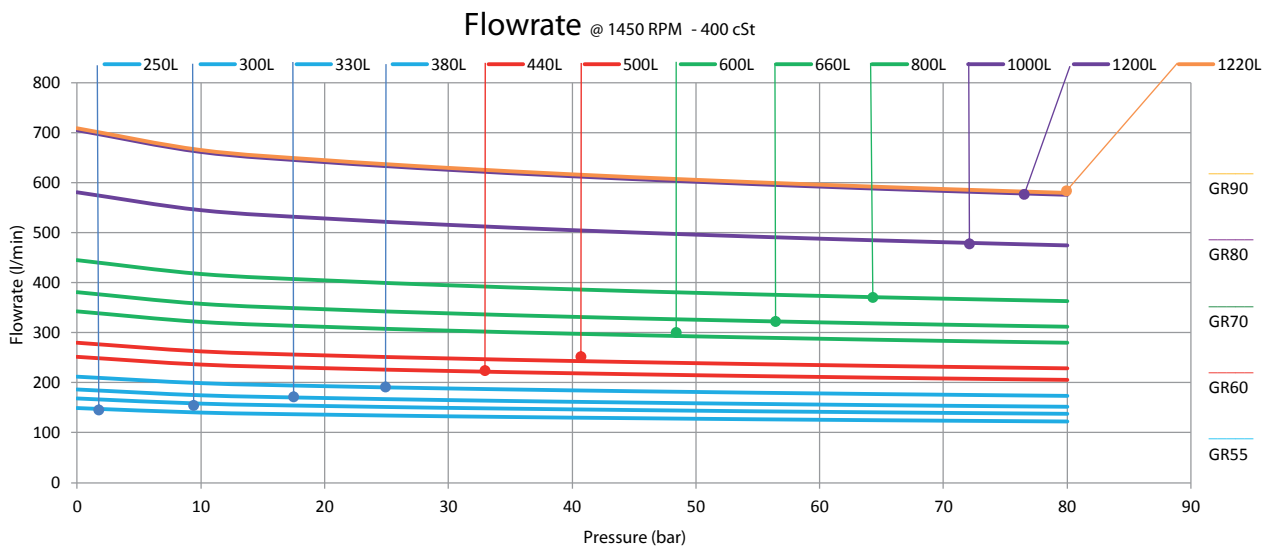
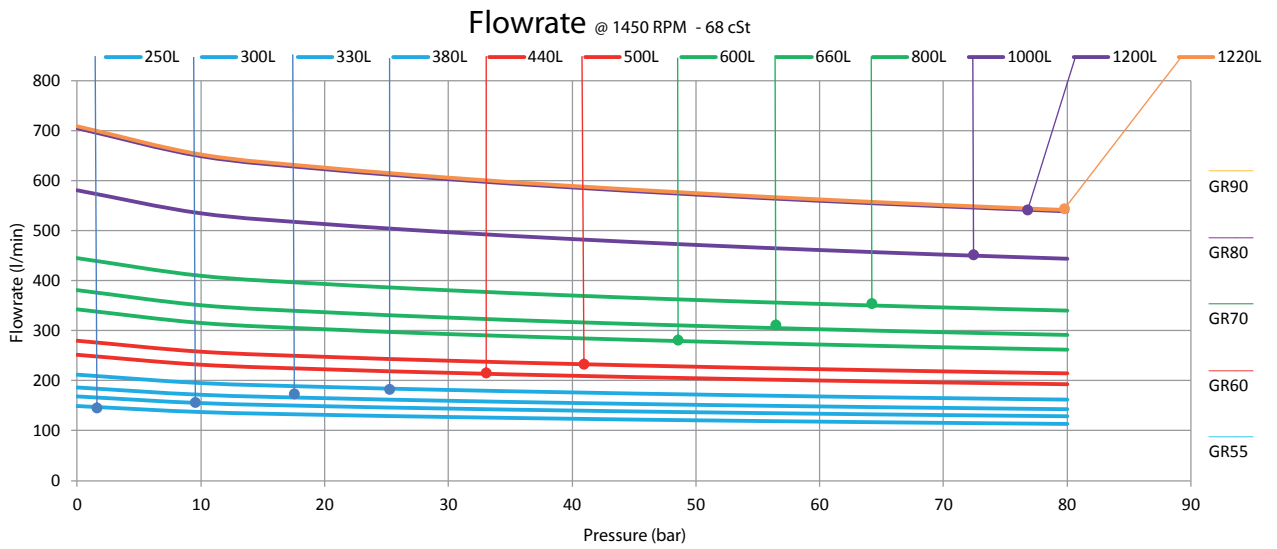
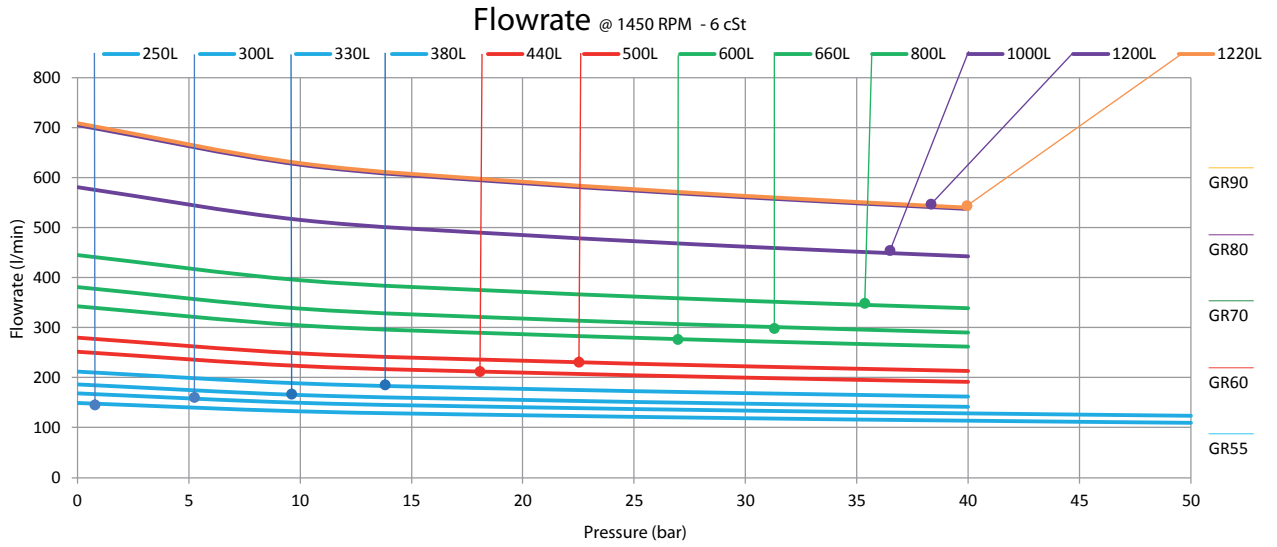

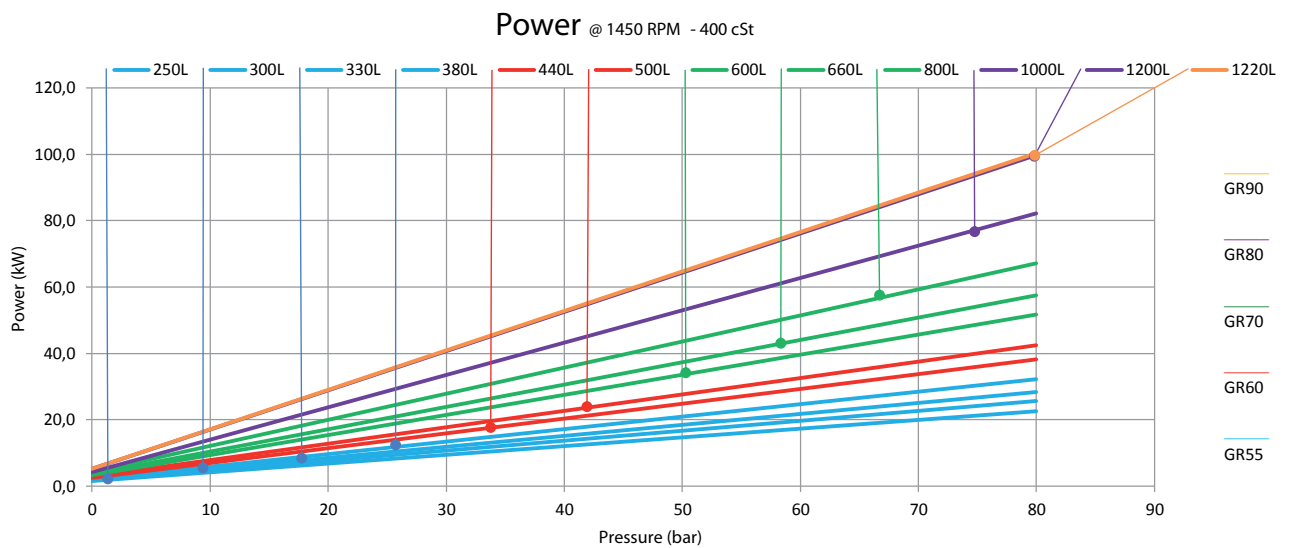
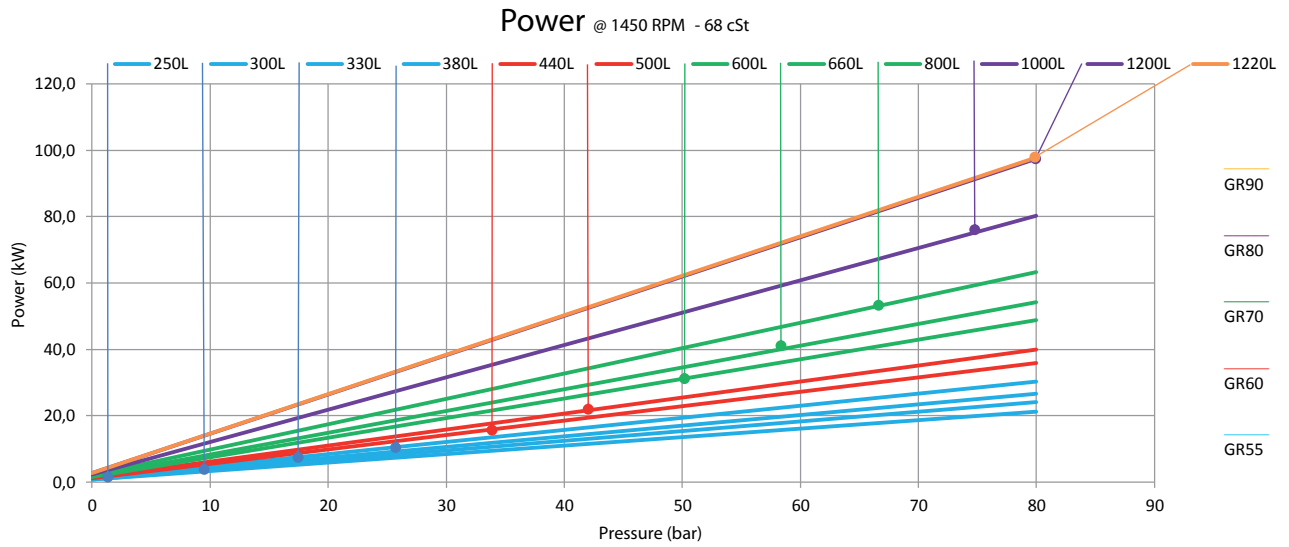
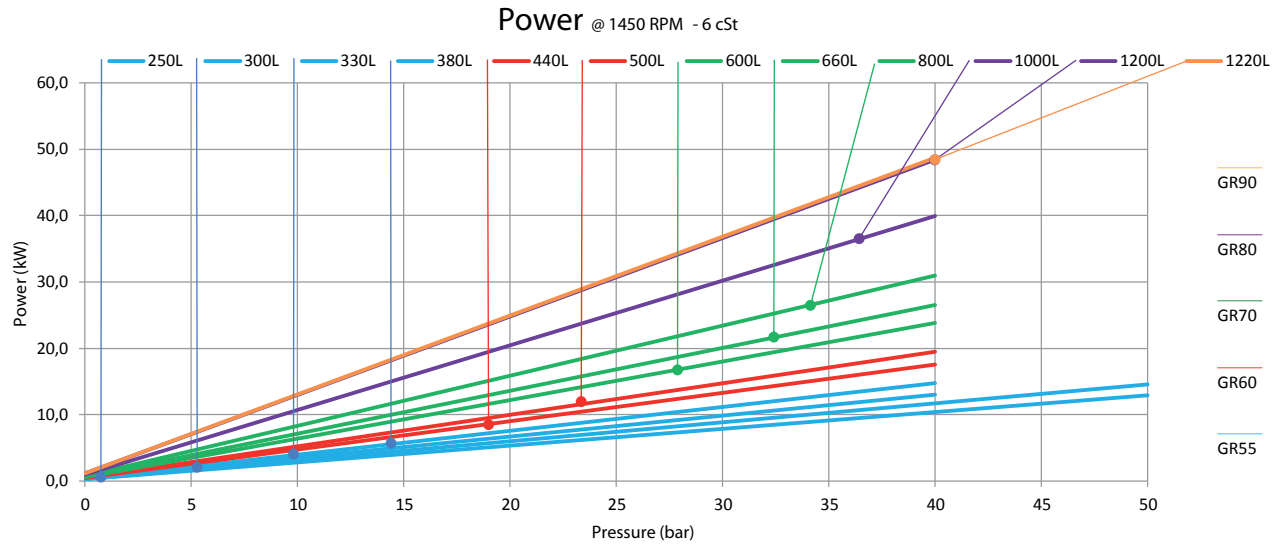

Performances @ 3000 - GR 55-60-70-80-90

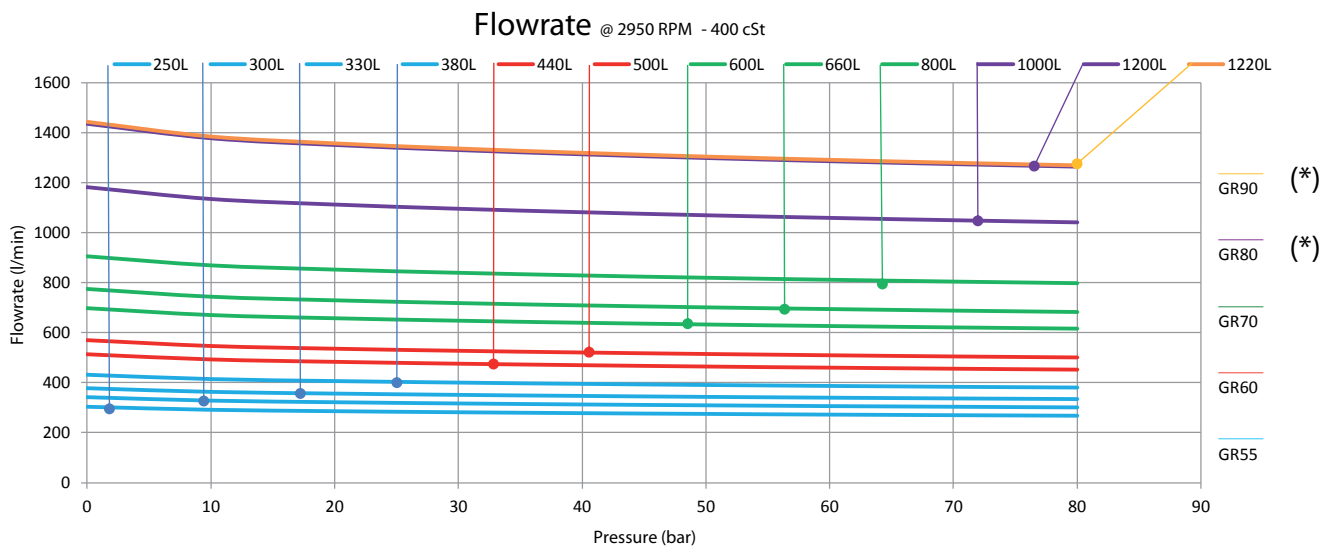
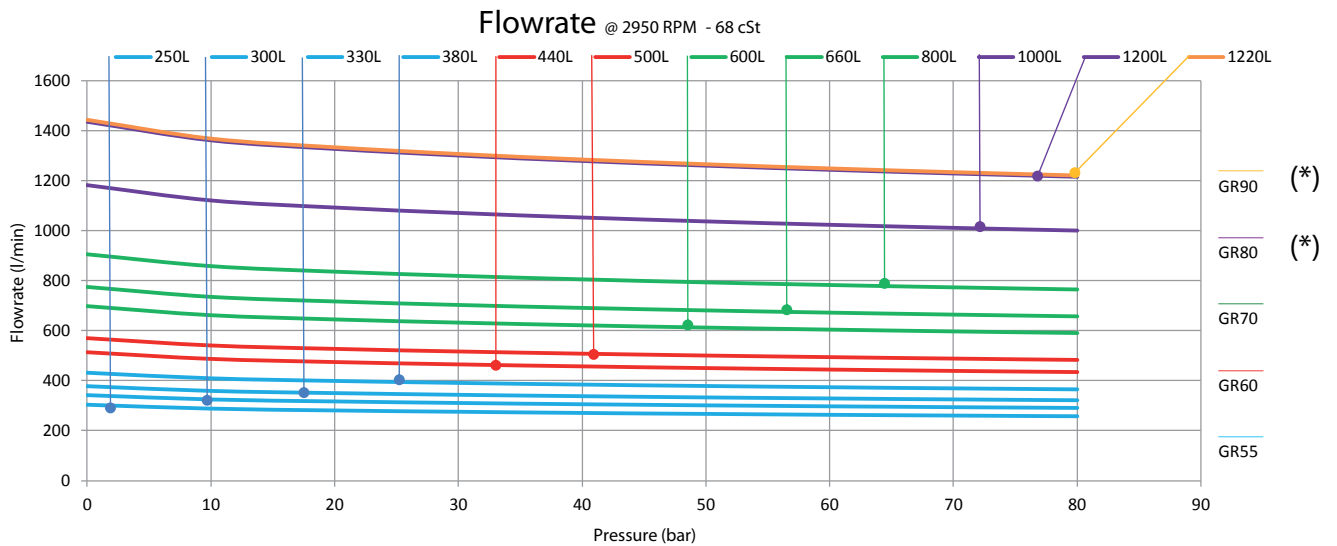
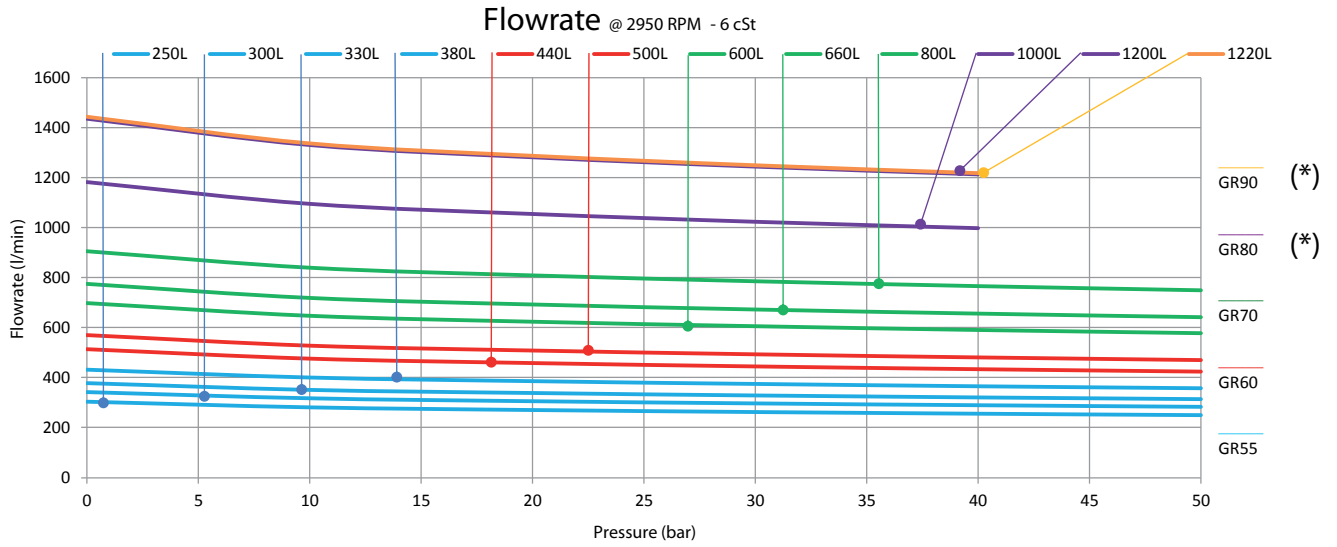

(*) For shaft speed lower than 1.000 rpm and over 1.800 rpm please contact Settima. Per velocità inferiori a 1.000 rpm e maggiori di 1.800 rpm contattare Settima.

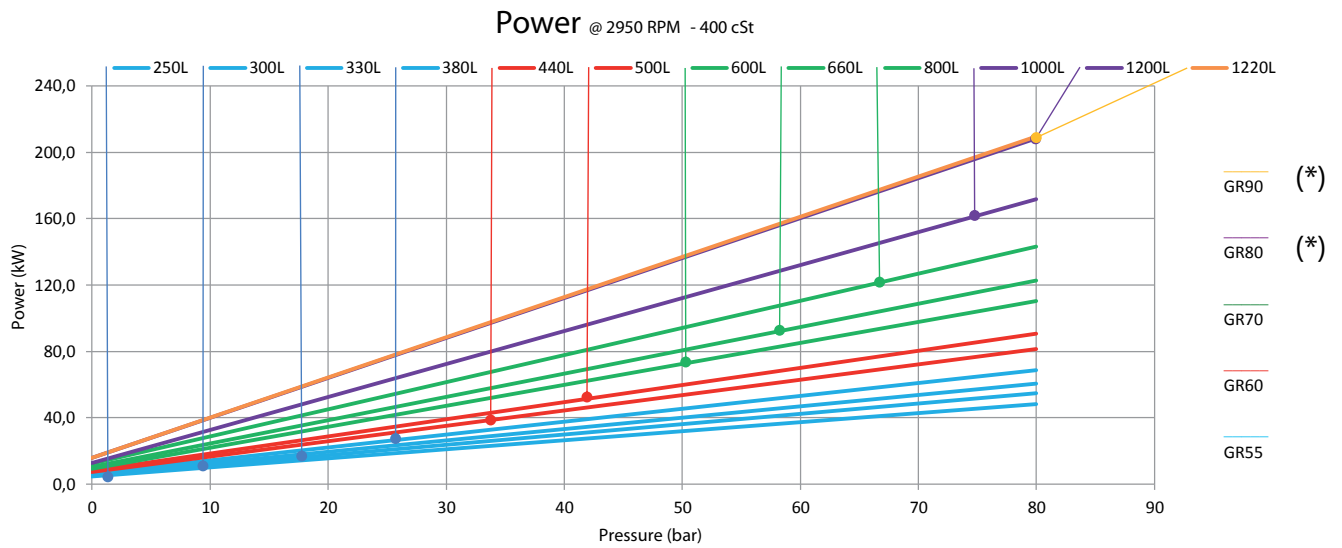
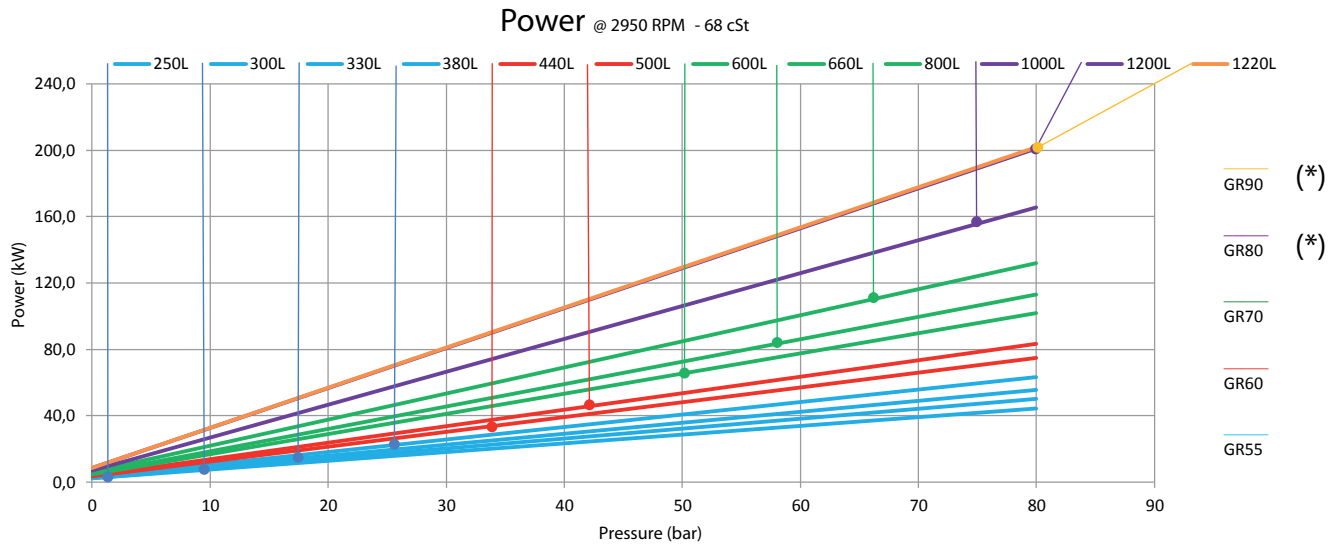
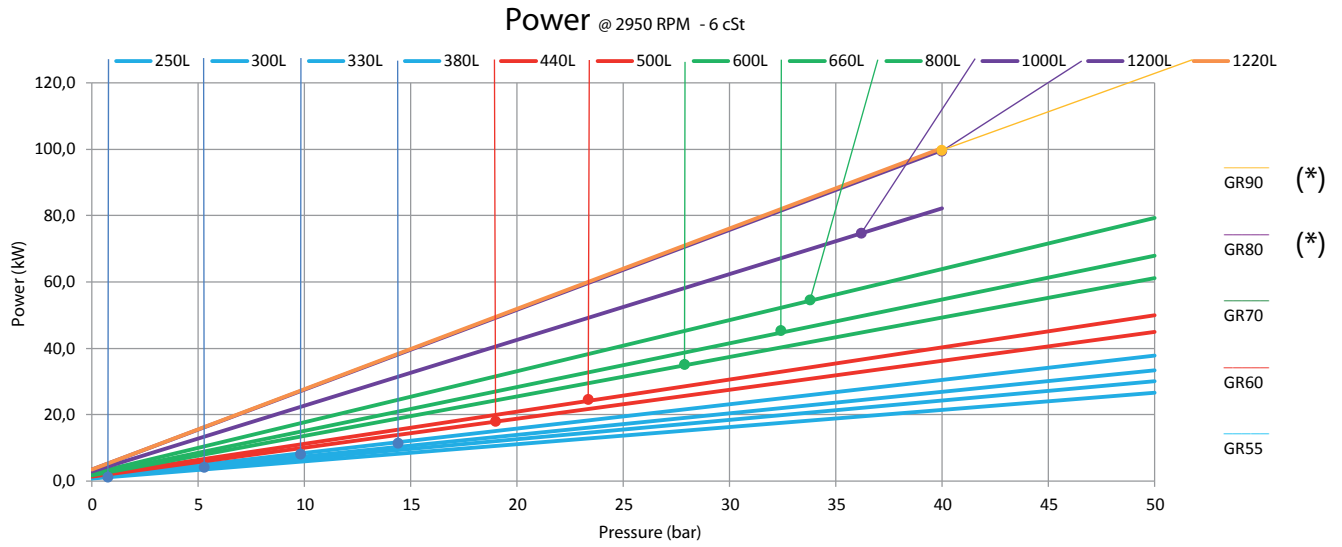

(*) For shaft speed lower than 1.000 rpm and over 1.800 rpm please contact Settima. Per velocità inferiori a 1.000 rpm e maggiori di 1.800 rpm contattare Settima.

All data reported by catalogue can change without any notice.



I dati presenti nel catalogo possono cambiare senza preavviso.

SETTIMA

Settima, Italy
Headquarter, r&d and production

SETTIMA

USA
Warehouse

SETTIMA

Shanghai, China
Warehouse

Settima Meccanica Srl
Settima - 29020 Piacenza (Italia)
tel. +39 0523.557623
fax +39 0523.557256
www.settima.it
info@settima.it

Settima Flow Mechanisms
Settima - 29020 Piacenza (Italia)
tel. +39 0523.557623
fax +39 0523.557256
www.settima.it
info@settimafm.com

 **SETTIMA MECCANICA**

Area Agency/Reseller

SETTIMA
flow mechanisms