

STRUCTURA GENERALA



Transmisie de mare putere



Racleti din plastic
secțiune transversală 8 x 8 mm



Suport hidraulic,
înălțime și unghi de înclinare
ușor de reglat



Banda albastră, utilizabilă
și în scopuri alimentare



Înălțimea laterală de 90 mm
realizată din material fără
frecare



Picioare modulare
telescopice

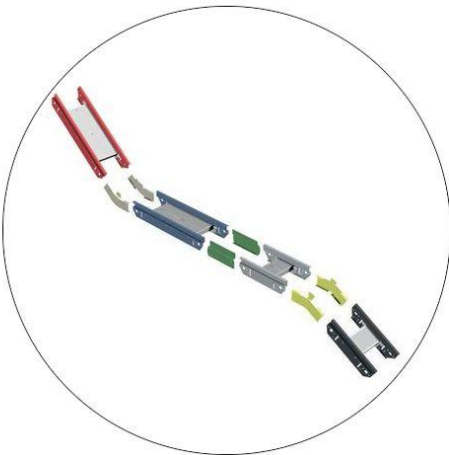

Structura scheletului este un sistem modular. Componentele sunt variabile, potrivite pentru toate tipurile. Pot fi realizate din oțel vopsit, aluminiu sau oțel inoxidabil.

BENZI TRANSPORT. STANDARDIZATE

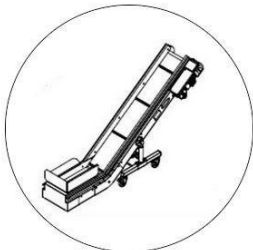

CB

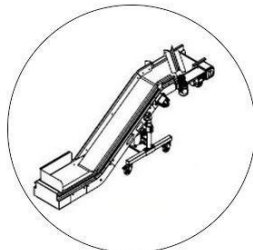

CBD

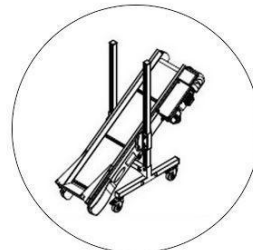

CL

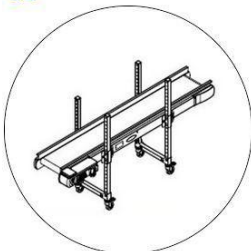

PNL

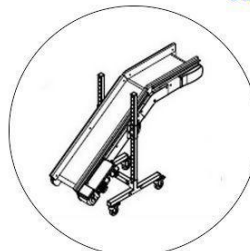

SV

BENZI TRANSPORT.PERSONALIZATE



CB/M



CBD/M



CL/M



PNL/M



SV/M

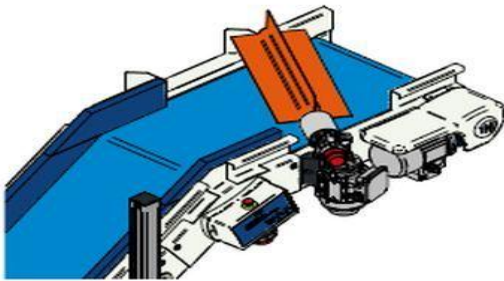
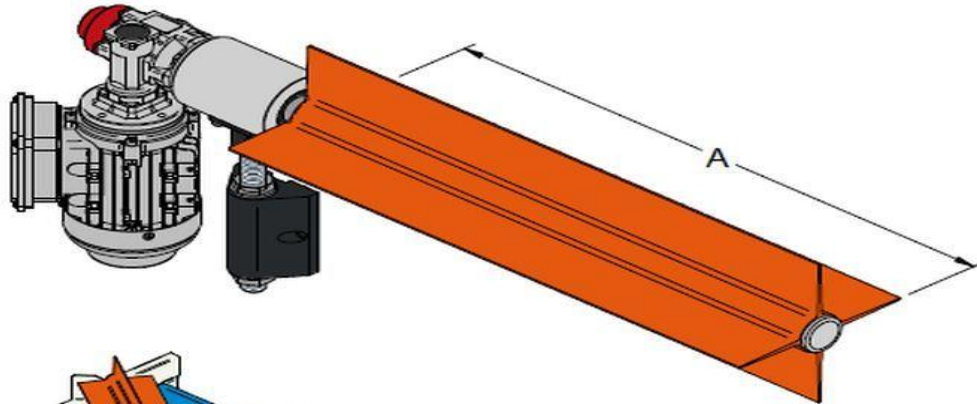

**Unitatea de separare cu paleti
a pieselor injectate de culee**