

MODEL NO	PASLANMAZ (STAINLESS)	SİYAH (BLACK)	F1 (N)	F2 (N)	F3 (N)	F4 (N)	Fi		BASKI VİDASI (SQUEEZE SCREW)	AÇI (ANGLE) (+ 5 °)		AĞIRLIK (WEIGHT) (gr)
							(X1 VERİM (YIELD) (F1:Fi))	(X2 VERİM (YIELD) (F2:Fi))		POS1	POS2	
211-0	S 211 -	B 211 -	550	350	700	455	10:1	5:1	M4X25	115°		85
211-1	S 211 -	B 211 -	750	500	1000	680	12:1	8:1	M5X35	105°		155
211-2	S 211 -	B 211 -	1200	700	1400	925	12:1	7,5:1	M6X40	105°		235
211-3	S 211 -	B 211 -	2000	1400	2500	1560	11:1	8:1	M8X50	105°		410
211-4	S 211 -	B 211 -	3000	2000	3300	2200	11,5:1	8:1	M10X70	135°	105°	890
211-5	S 211 -	B 211 -	4500	2500	5000	3000	12:1	7:1	M12X80	135°	105°	1510

F1 - F2 : BASKI KUVVETİ (EXERTING FORCE) , F3 - F4 : TUTMA KAPASİTESİ (HOLDING CAPACITY) , Fi : UYGULAMA KUVVETİ (APPLIED FORCE)

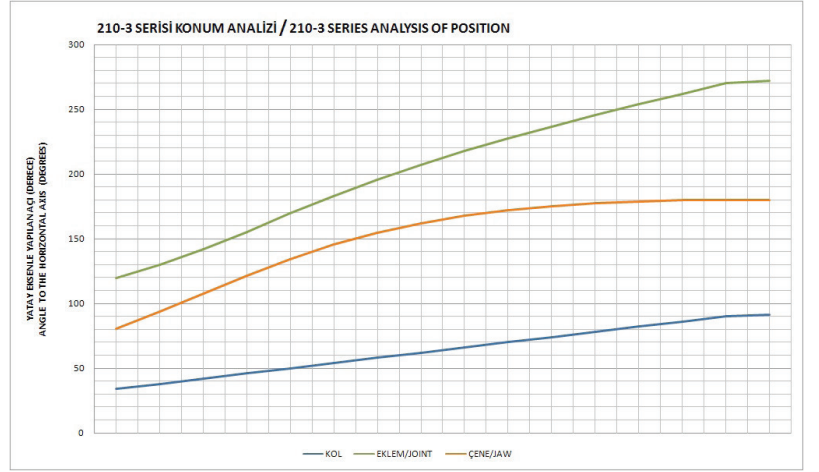

Ayak Tipi: Yatay Tabanlı
Body Mounting Base: Horizontal

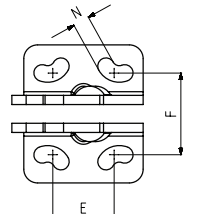
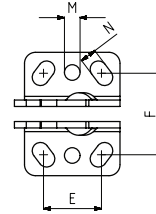
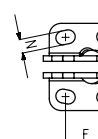
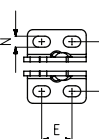
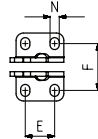
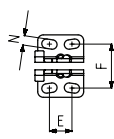
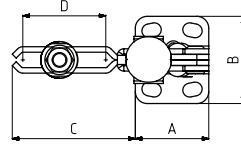
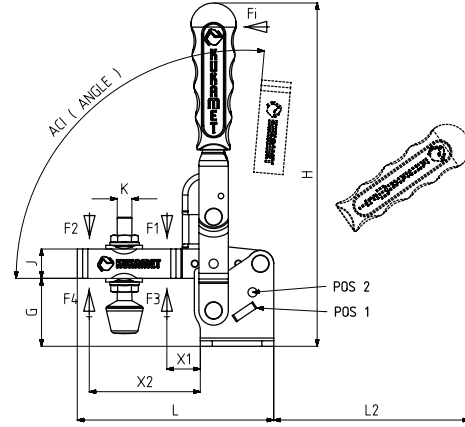

MODEL NO : 211-0

MODEL NO : 211-1

MODEL NO : 211-2

MODEL NO : 211-3

MODEL NO : 211-4

MODEL NO : 211-5

MODEL NO	A	B	C	D	E	F	G	H	J	K	L	L2	M	N	X1	X2
211-0	25	34	31	20	9 - 15,5	23,5 - 24	18	85	8	M4	56	50		5x8	11	22
211-1	26	37	44	26	16	24 - 27	23	125	10	M5	70	75		5x6,5	18	34
211-2	32	40	62	42	13 - 20	27	26	141	13	M6	94	85		6x9,5	20	50
211-3	40	47,5	67	42	19 - 25	31,5 - 32,5	37	187	16	M 8	107	110		7,5x10,5	25	52
211-4	52	67	100	67	28 - 34,5	40 - 48,5	47	240	20	M10	152	160	8,5	9x14,5	34	82
211-5	65	75	130	88	24,5 - 45	44,5 - 52	58	263	25	M12	195	165		9x19,5	42	107