



LOFT  
**LADDERS**  
2016 JULY

**25**  
YEARS  
OF INNOVATION

**FAKRO**<sup>®</sup>

# IT FOLDS SO EASILY....



## FOLDING LOFT LADDERS





# FOLDING LOFT LADDERS

enable safe and easy access to loft spaces without the need for costly and space-consuming staircases. FAKRO ladders satisfy all technical and safety requirements whilst maximising ease of use and comfort.



## SPACE SAVINGS

FAKRO loft ladders require little 'swing space'. The ladder is mounted on the hatch so that, when folded, its sections are neatly concealed inside the loft space.

## EASE OF OPERATION

The innovative spring-assisted opening mechanism (on some models ladder sections are also sprung) greatly eases ladder use. An opening rod is also supplied with every ladder.

## EASE OF INSTALLATION

To make installation easier, 'click' fixings enable some FAKRO loft ladders to be fitted by a single person. All can be installed with ease, however and can be adjusted to suit ceiling height.

**Ladders come fully assembled and do not require any additional pre-installation work.**

## ADDITIONAL EQUIPMENT

In order to maximise comfort and accelerate installation of the loft ladder, additional accessories are available.

## WARRANTY

FAKRO loft ladders come with a **3-year warranty.**











# LOFT LADDERS

## TYPES AND CHOICE OF LOFT LADDER

FAKRO offers a choice of wood and metal loft ladders to satisfy the needs of each individual customer and home. **All FAKRO folding ladders offer a high degree of thermal efficiency to reduce heat loss and meet the requirements of BS 14975:2006.** The most popular ladder in the range, the **LWK Komfort**, is supplied with a handrail, protective stile ends, and a white hatch. To reduce installation time, choose the **LWZ Plus** or, for added user comfort you



		LWK KOMFORT		LWZ PLUS		LWL		HIGHLY-INSULATED LTK ENERGY		LWT		FIRE RESISTANT LWF 45	
													
Thickness of thermal insulation [cm]		3		3		3		6		7,4		7,4	
Heat transmittance coefficient U [W/m²K]		1.1		1.1		1.1		0.68		0.51		0.60 <sup>1</sup>	
Fire resistance class according to EN13501-2		—		—		—		—		—		E <sub>1</sub> 45	
Box height [cm]		14		14		14		18		22		22	
System of quick installation in the ceiling		—		+		—		—		—		—	
Ladder section		wooden		wooden		wooden		wooden		wooden		wooden	
Width of the tread [cm]		8		8		8		8		8		8	
Ceiling Height [cm]	maximum (standard)	280	305	280	305	280	305	280	305	280	305	280	305
	minimum <sup>2</sup>	232/250 <sup>3</sup>	246	232	246	260	260	235/253 <sup>3</sup>	243	234	255	234	242
	with attached LSS <sup>4</sup>	—	—	—	—	—	—	—	—	—	—	—	—
Max. loading		160 kg		160 kg		160 kg		160 kg		160 kg		160 kg	
													
		page 10		page 12		page 14		page 16		page 18		page 22	

<sup>1</sup> manufacturer's own data

















<sup>2</sup> Note! for rooms lower than the maximum height the ladder's section has to be cut to measure according to instructions

<sup>3</sup> for 4-section loft ladders

<sup>4</sup> LSS tread suitable for a given type and width of ladders











can go for the **LWL** which is equipped with a second handrail and added spring assistance for opening and closing. For energy efficiency, the thermally-efficient **LTK Energy** ladder provides very low U-value. The highly insulated **LWT** ladder is also equipped with three seals to provide total airtightness. Where there may be limited ceiling height and space, a sliding ladder such as the **LDK**, which is similarly equipped to the **LWK**, is ideal. Where fire resistance is needed, we can offer a choice of three models: the **LWF 45** with timber sections, the **LMF** with metal sections and the **LSF** metal scissor ladder. Other scissor ladders include the **LST** and **LSZ** which have been designed for situations where space available makes it impractical to use standard folding section ladders. For ladders which are likely to see heavy usage, the **LMS** is equipped with a reinforced metal section. The folding **LMK** is also equipped with a handrail and white hatch while, for those wanting simple installation and ease of use in a metal ladder the **LML** will offer the perfect solution.

SLIDING SECTION			FOLDING METAL SECTION INSULATED					SCISSORS					
INSULATED			INSULATED			FIRE-RESISTANT		INSULATED		FIRE-RESISTANT			
LDK			LMS	LMK	LML	LMF		LST	LSZ	LSF			
													
3			3	3	3	8		3	3	3			
1.1			1.1	1.1	1.1	0.79 <sup>1</sup>		1.1	1.1	1.8 <sup>1</sup>			
—			—	—	—	E <sub>2</sub> 120		—	—	E <sub>2</sub> 60			
14			14	14	31,5	16		18	14	14			
—			—	—	+	+		+	+	+			
wooden			metal	metal	metal	metal		metal	metal	metal			
8			8	8	13	13		8	8	8			
280	300	335	280	305	280	305	280	305	280	280	300		
200			220	245	220	245	233	256	233	256	230	230	240
—			—	—	—	—		—	290-330	290-330	310-320		
160 kg			200 kg	200 kg	200 kg	200 kg		200 kg	200 kg	200 kg			
													
page 24			page 30	page 32	page 34	page 36		page 40	page 42	page 44			

# L-SHAPED COMBINATION DOORS

## TYPES AND CHOICE OF L-SHAPED DOOR

In addition to having a wide range of loft ladders FAKRO also manufactures combination loft doors for installation in walls. These are used to provide access to unused space behind a wall or under stairs. Three models are available, the first and most basic model, the **DWK** insulating door having a 3.6cm thick sash. For added thermal efficiency and airtightness the **DWT** provides a U-value of 0.6 and offers Class 4: EN 12207 performance. Where fire resistance is required, the **DWF** offers double-sided protection (fire classification EI,45 EN 13501-2), as well as exceptional airtightness and thermal insulation.

Insulated	Highly energy efficient	Fire-resistant
<b>DWK</b>	<b>DWT</b>	<b>DWF</b>
	 	  
		
page 46	page 48	page 50





**WOODEN SECTION**  
LOFT LADDERS



# SECTION LOFT LADDERS

## ► BOX

The loft ladder has a pine or metal frame integrated within its box. It comes complete with linings which, in combination with a quick installation system gets the job done fast! The peripheral seal is used to ensure the ladder aperture remains airtight.

## ► HATCH MECHANISM

The used mechanism significantly simplifies ladder operation. The hatch after unlocking opens slowly without causing any hazard to the user. In addition, the mechanism maintains the hatch in fully open position, prevents it from spontaneous closing during unfolding and folding the ladder.

## ► HARDWARE

The patented corner hinge and spring mechanism provides added rigidity to the box and prevents distortion.

## ► HATCH

The sandwich type hatch can be insulated or fire-resistant.

## ► TREAD

The grooves on the tread surface protect the user from accidental slipping while using the ladder.

## ► LADDER

The ladder is made of high quality pine and consists of three or four segments.

## ► STILE ENDS

made from heavy duty PVC, these protect the floor surface from scratching while also adding to the ladder's overall stability (refers to 3-section ladders)

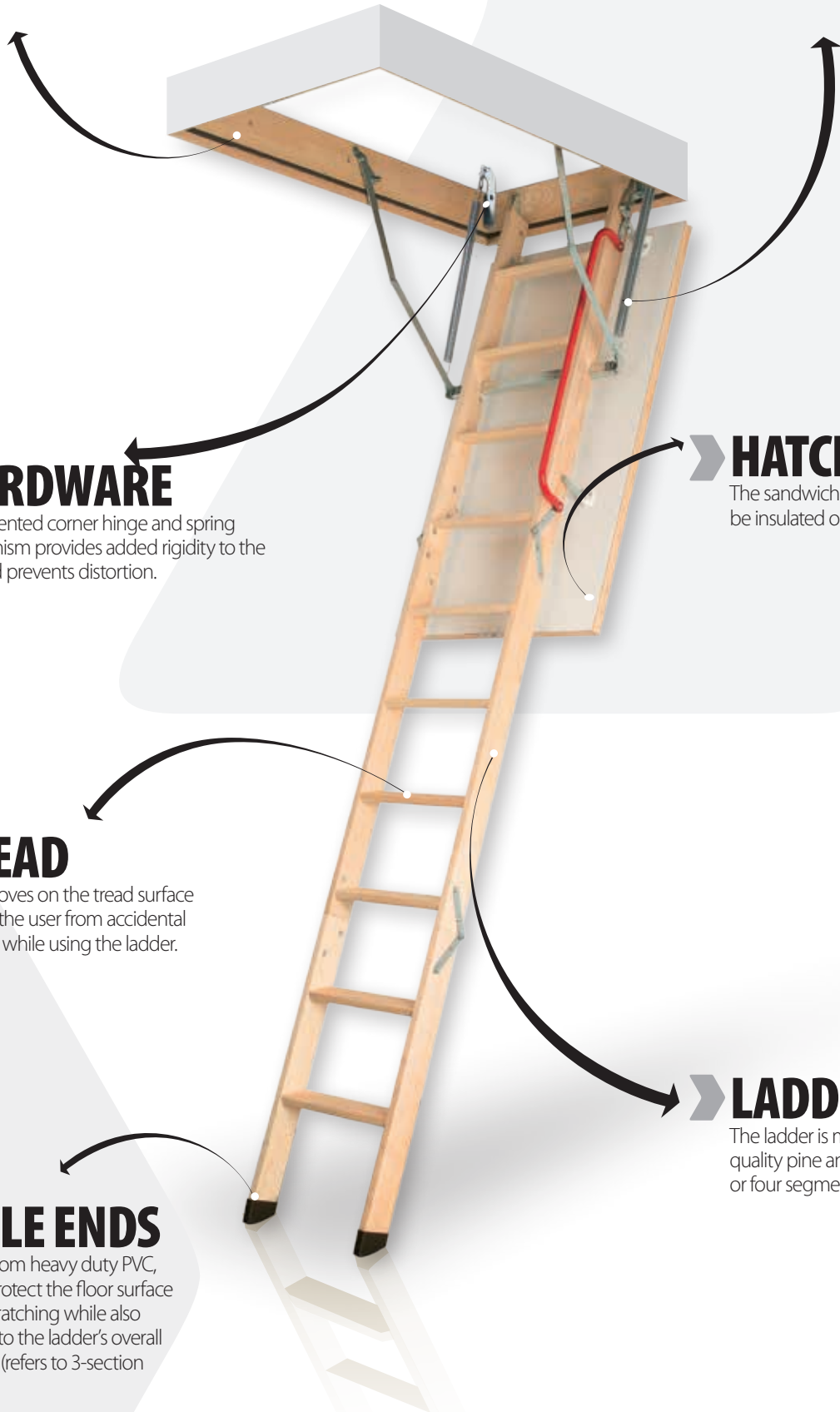



WOODEN  
LOFT LADDERS



# WOODEN FOLDING SECTION LOFT LADDERS

**LWK**  
KOMFORT

STANDARD  
**EN**  
**14975**

**U=1.1**  
W/m<sup>2</sup>K

The **LWK Komfort** ladder's innovative design ensures ease of use, a high insulation value and quick installation. It is equipped with an aesthetically pleasing, smooth white finish to the hatch, and a handrail as standard.

Insulated white hatch and handrail.

As the hatch is opened the hinge moves it away from the ladder, thus increasing space for added convenience.

Low weight and innovative way of hooking the hatch on the so-called 'click' allows for installation of the loft ladder by one person.

**CLICK**



stile ends (only in 3-section version)



handrail



white hatch



non-slip treads set flush with ladder strings



peripheral seal



easy installation



possibility of installing additional accessories, pages 52-57

Technical specification:  
**permissible load of 160 kg**  
**heat transmission coefficient U = 1.1 W/m<sup>2</sup>K**  
**insulation thickness 3 cm**  
**hatch thickness 3.6 cm**

fully assembled,  
and ready for quick  
installation in the ceiling



**3** years  
WARRANTY



# LWK KOMFORT LADDER DIAGRAM

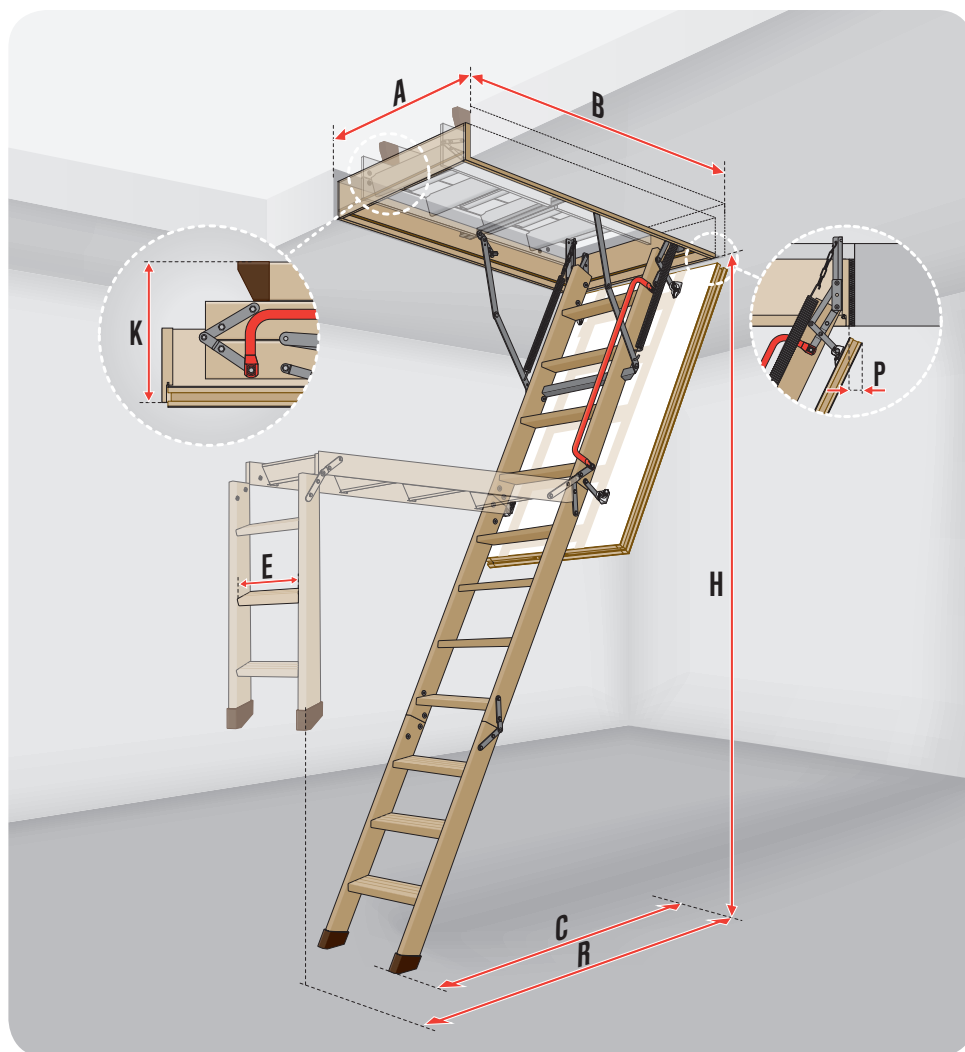

## LWK Komfort LOFT LADDER DIMENSIONS

Ceiling opening dimensions [cm]	AxB	55x111	60x94	60x100	60x111	60x120	60x130	70x94	70x100	70x111	70x120	70x130	70x140	60x130	60x140	70x130	70x140
Room height [cm]	H	280												305			
Box external dimensions [cm]		53x109.4	58x92.4	58x98.4	58x109.4	58x118.4	58x128.4	68x92.4	68x98.4	68x109.4	68x118.4	68x128.4	68x138.4	58x128.4	58x138.4	68x128.4	68x138.4
Internal box dimensions [cm]		49x105	54x88	54x94	54x105	54x114	54x124	64x88	64x94	64x105	64x114	64x124	64x134	54x124	54x134	64x124	64x134
Folded ladder height [cm]	K	27	35		27			35		27							
Swing space [cm]	R	153	128		153	156		128		153	156		175				
Distance after ladder unfolding [cm]	C	113	114		113	120		114		113	120		135				
Hatch retraction after opening [cm]	P													4			
Box height [cm]														14			
Number of segments		3	4		3			4		3							

## LADDER PARAMETERS

Tread length [cm]	E	30	34															
Tread width [cm]											8							
Distance between treads [cm]											25							
Tread thickness [cm]											2							

## LOFT LADDER DIMENSIONS

Commercial sizes [cm]		55x111	60x94	60x100	60x111	60x120	60x130	70x94	70x100	70x111	70x120	70x130	70x140	60x130	60x140	70x130	70x140
Room height [cm]	H	280												305			
Code		863821	863807	863806	863804	863801	863802	863817	863816	863814	863811	863812	863813	863851	863852	863853	863854

For LWK Komfort non-standard sizes page 27

WOODEN  
LOFT LADDERS



# WOODEN SECTION LOFT LADDERS

**NEW!**

**LWZ  
PLUS**



Quick-fit brackets built into steel frame speeds up installation and makes levelling within the ceiling easy.

Integrated architrave lining gives a highly pleasing finish to the installed ladder.

Hinge controls hatch movement and moves it away from the ladder sections for greater ease of use.

STANDARD  
**EN  
14975**

**U=1.1**  
W/m<sup>2</sup>K

The **LWZ Plus** loft ladder combines the advantages of the latest design and quick fitting. The integrated steel frame, installation brackets and metal architrave lining make installation simple and finish off any imperfections and gaps between frame and ceiling.



stile ends



white hatch



architrave



peripheral seal



handrail



non-slip treads



system of quick installation in the ceiling



possibility of installing additional accessories pages 52-57

Technical specification:  
**permissible load of 160 kg**  
**heat transmission coefficient U = 1.1 W / m<sup>2</sup>K**  
**insulation thickness 3 cm**  
**hatch thickness 3.6 cm**

fully assembled,  
and ready for quick  
installation in the ceiling



**3 years**  
WARRANTY

# LWZ PLUS LADDER DIAGRAM

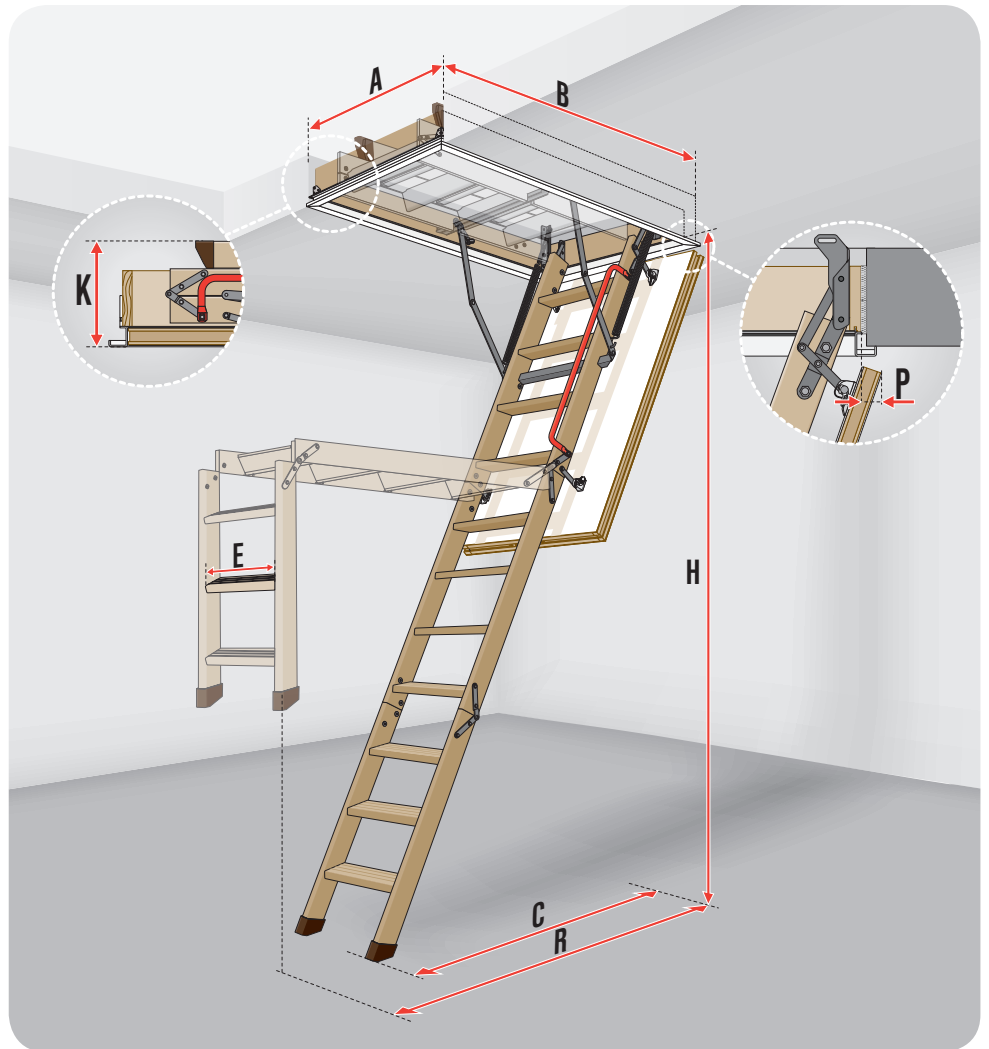

## LWZ Plus LOFT LADDER DIMENSIONS

Ceiling opening dimensions [cm]	AxB	60x120	70x120	70x130	70x140	60x130	70x130	70x140
Room height [cm]	H	280				305		
Box external dimensions [cm]		58.8x118.8	68.8x118.8	68.8x128.8	68.8x138.8	58.8x128.8	68.8x128.8	68.8x138.8
Internal box dimensions [cm]		54x114	64x114	64x124	64x134	54x124	64x124	64x134
Folded ladder height [cm]	K	27						
Swing space [cm]	R	156			175			
Distance after ladder unfolding [cm]	C	120			135			
Hatch retraction after opening [cm]	P	4						
Box height [cm]		14						

## LADDER PARAMETERS

Tread length [cm]	E	34						
Tread width [cm]		8						
Distance between treads [cm]		25						
Tread thickness [cm]		2						

## LOFT LADDER DIMENSIONS

Commercial sizes [cm]		60x120	70x120	70x130	70x140	60x130	70x130	70x140
Room height [cm]	H	280				305		
Codes		865701	865711	865712	865713	865751	865753	865754

Ladders are available only in sizes shown above.



# WOODEN SECTION LOFT LADDERS

**LWL**  
LUX

STANDARD  
**EN**  
**14975**

**U=1.1**  
W/m<sup>2</sup>K

The **LWL Lux** loft ladder is equipped with an additional handrail in the middle folding section and a special gas-assisted spring mechanism. The special hatch construction has enabled the need for a lock to be eliminated.

Additional handrail ensures comfort and ease of use.

The gas-assisted spring makes folding and unfolding far easier.



stile ends



white hatch



peripheral seal



handrail



non-slip treads with additional depth



unloading mechanism



possibility of installing additional accessories pages 52-57

Technical specification:  
**permissible load of 160 kg**  
**heat transmission coefficient U = 1.1 W / m<sup>2</sup>K**  
**insulation thickness 3 cm**  
**hatch thickness 3.6 cm**

fully assembled,  
and ready for quick  
installation in the ceiling



**3** years  
WARRANTY

# LWL LUX LADDER DIAGRAM

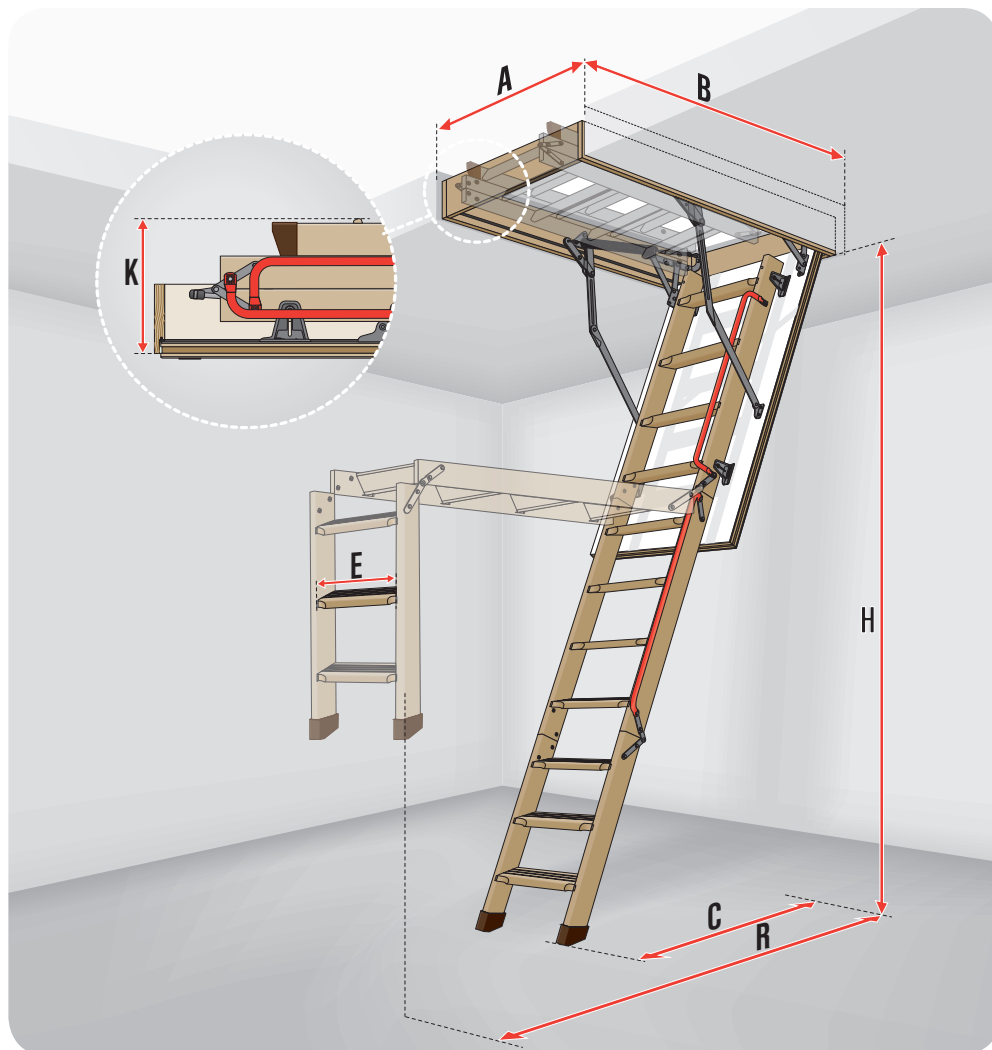

## LWL Lux LOFT LADDER DIMENSIONS

Ceiling opening dimensions [cm]	AxB	60x120	70x120	70x130	70x140	60x130	70x130	70x140
Room height [cm]	H	280				305		
Box external dimensions [cm]		58x118	68x118	68x128	68x138	58x128	68x128	68x138
Internal box dimensions [cm]		54x114	64x114	64x124	64x134	54x124	64x124	64x134
Folded ladder height [cm]	K	34						
Swing space [cm]	R	164			179			
Distance after ladder unfolding [cm]	C	122			130			
Box height [cm]		14						

## LADDER PARAMETERS

Tread length [cm]	E	30	34	30	34
Tread width [cm]		8			
Distance between treads [cm]		25			
Tread thickness [cm]		2			

## LOFT LADDER DIMENSIONS

Commercial sizes [cm]		60x120	70x120	70x130	70x140	60x130	70x130	70x140
Room height [cm]	H	280				305		
Code		862001	862011	862012	862013	862051	862053	862054

Ladders are available only in sizes shown above.

# WOODEN SECTION LOFT LADDERS

**NEW!**

**LTK  
ENERGY**



Short distance between the top tread and attic floor.



Double system of seals guarantees perfect tightness.



Light hatch weight and method of 'click fixing' makes installation very simple.



Highly energy-efficient, 6.6cm thick hatch prevents heat loss, making significant saving on energy bills.

**4** CLASS  
EN12207

STANDARD  
**EN  
14975**

**U=0.68**  
W/m<sup>2</sup>K



The **LTK Energy** is highly energy efficient new generation loft ladder intended for energy-efficient buildings. They guarantee a high level of comfort, excellent thermal insulation parameters and the highest Class 4 tightness.



stile ends



white hatch



non-slip treads set flush with ladder strings



two seals



easy installation



handrail



possibility of installing additional accessories pages 52-57

Technical specification:  
**maximum load of 160 kg**  
**heat transmission coefficient U = 0.68 W / m<sup>2</sup>K**  
**insulation thickness 6 cm**  
**hatch thickness 6.6 cm**

fully assembled,  
and ready for quick  
installation in the ceiling



**3** years  
WARRANTY



# LTK ENERGY LADDER DIAGRAM

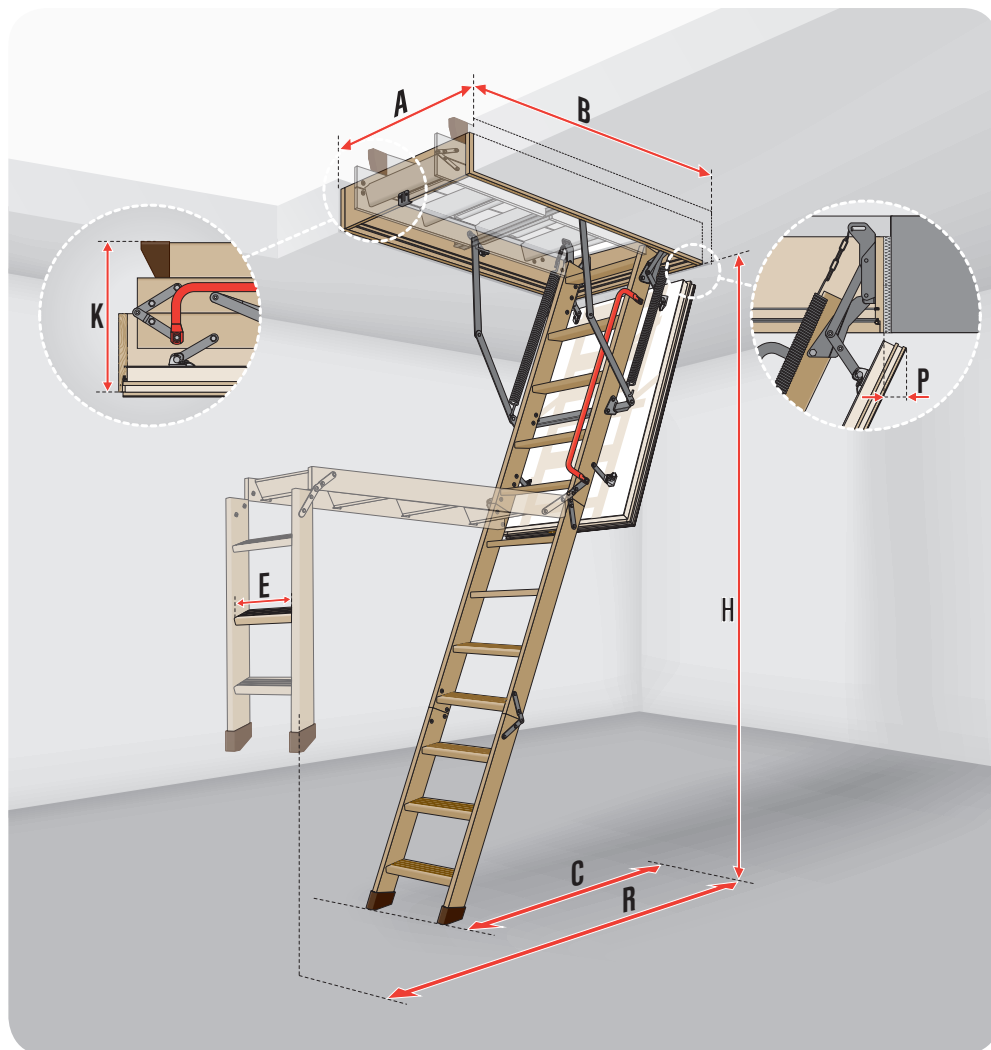

## LTK ENERGY LOFT LADDER DIMENSIONS

Ceiling opening dimensions [cm]	A x B	55x100	60x100	70x100	60x120	70x120	70x130	70x140	60x130	70x130	70x140
Room height [cm]	H	280								305	
Box external dimensions [cm]		53x98.4	58x98.4	68x98.4	58x118.4	68x118.4	68x128.4	68x138.4	58x128.4	68x128.4	68x138.4
Internal box dimensions [cm]		49x94	54x94	64x94	54x114	64x114	64x124	64x134	54x124	64x124	64x134
Folded ladder height [cm]	K	42				35					
Swing space [cm]	R	136				164				178	
Distance after ladder unfolding [cm]	C	123				129				139	
Hatch retraction after opening [cm]	P							3			
Box height [cm]								18			
Number of segments		4				3					

## LADDER PARAMETERS

Tread length [cm]	E	30	34								
Tread width [cm]								8			
Distance between treads [cm]								25			
Tread thickness [cm]								2			

## LOFT LADDER

Commercial sizes [cm]		55x100	60x100	70x100	60x120	70x120	70x130	70x140	60x130	70x130	70x140
Room height [cm]	H	280								305	
Code		864720	864706	864716	864701	864711	864712	864713	864751	864753	864754

Ladders are available only in sizes shown above.

WOODEN  
LOFT LADDERS

# WOODEN SECTION LOFT LADDERS

LWT

**4** CLASS  
EN12207

STANDARD  
**EN**  
14975

**U=0.51**  
W/m²K

The highly efficient **LWT** loft ladder is recommended for use in energy-efficient buildings. Its excellent level of insulation significantly reduces heat loss and energy bills.

Triple system of seals guarantees perfect tightness.

Light hatch weight and method of 'click fixing' makes installation very simple.

Short distance between the top tread and attic floor.

Its special 8cm thick hatch is filled with polystyrene insulation to provide an excellent barrier and reduce heat loss.



stile ends



white hatch



three seals



handrail



non-slip treads set flush with ladder strings



easy installation



possibility of installing additional accessories

Technical specification:  
**permissible load of 160 kg**  
**heat transmission coefficient U = 0.51 W / m²K**  
**insulation thickness 7.4 cm**  
**hatch thickness 8 cm**

fully assembled,  
and ready for quick  
installation in the ceiling



**3** years  
WARRANTY

# LWT LOFT LADDER DIAGRAM

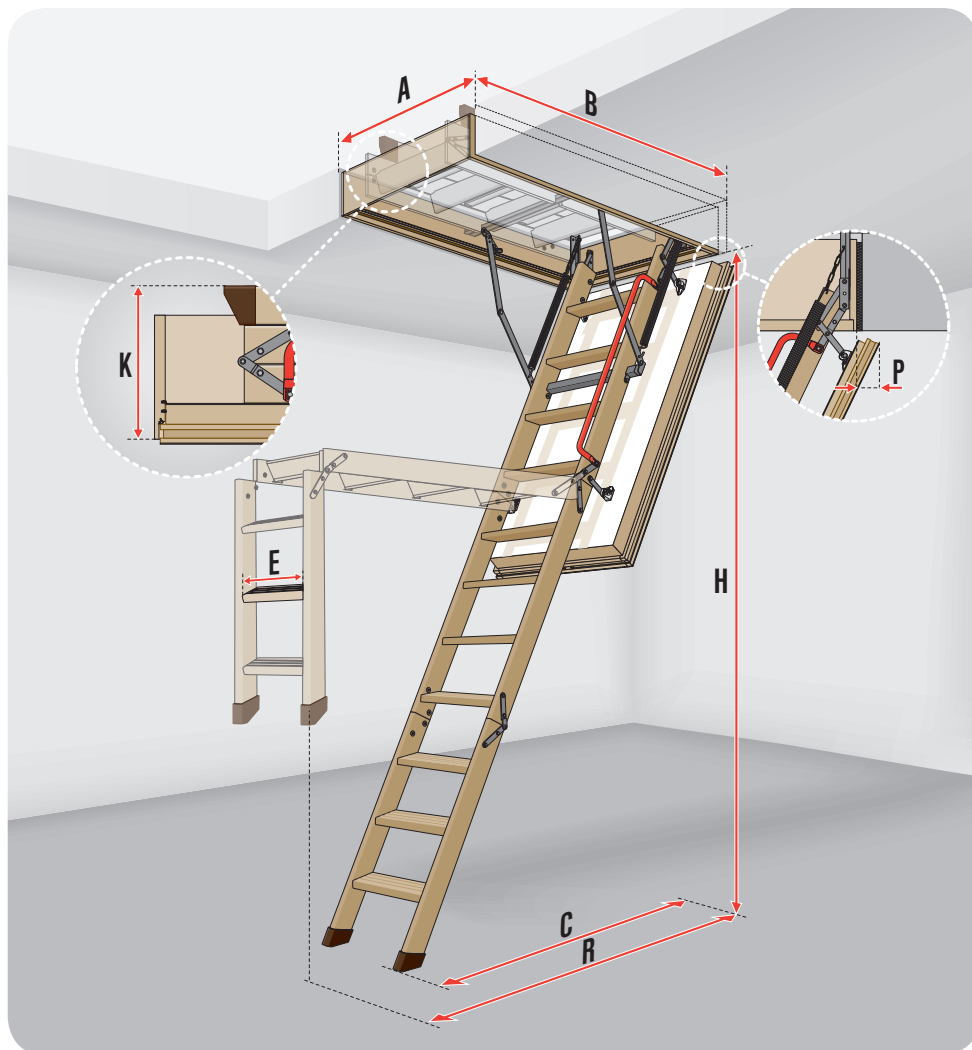

## LWT LOFT LADDER DIMENSIONS

Ceiling opening dimensions [cm]	AxB	60x120	70x120	70x130	70x140	60x130	70x130	70x140
Room height [cm]	H	280				305		
Box external dimensions [cm]		58x118.4	68x118.4	68x128.4	68x138.4	58x128.4	68x128.4	68x138.4
Internal box dimensions [cm]		54x114	64x114	64x124	64x134	54x124	64x124	64x134
Folded ladder height [cm]	K	33						
Swing space [cm]	R	160				175		
Distance after ladder unfolding [cm]	C	127				135		
Hatch retraction after opening [cm]	P					6.5		
Box height [cm]						22		

## LADDER PARAMETERS

Tread length [cm]	E	34						
Tread width [cm]		8						
Distance between treads [cm]		25						
Tread thickness [cm]		2						

## LOFT LADDER

Commercial sizes [cm]		60x120	70x120	70x130	70x140	60x130	70x130	70x140
Room height [cm]	H	280				305		
Code		863101	863111	863112	863113	863151	863153	863154

Ladders are available only in sizes shown above.



WOODEN  
LOFT LADDERS



# LOFT LADDERS WITH WOODEN FOLDING SECTION

**NEW!**

**LWT**  
PASSIVE  
HOUSE

**4** CLASS  
EN12207

STANDARD  
**EN**  
**14975**

**U=0.51**  
W/m<sup>2</sup>K



Kit allows for proper loft ladder insulation in the ceiling.

The **LWT Passive House** loft ladder is a technically complex design specifically developed for the demands of such energy-efficient construction standards. It is installed with a kit which connects the ladder to the ceiling to guarantee a perfect seal and insulation without thermal bridges. It comes with Passive House certification.



stile ends



PASSIVE HOUSE  
Insulation kit



white hatch



non-slip treads set flush  
with ladder strings



three seals  
x3



easy installation



handrail



possibility of installing  
additional accessories  
pages 52-57

Technical specification:  
**permissible load of 160 kg**  
**heat transmission coefficient U = 0.51 W / m<sup>2</sup>K**  
**insulation thickness 7.4 cm**  
**hatch thickness 8 cm**

fully assembled,  
and ready for quick  
installation in the ceiling



**3** years  
WARRANTY

# LWT LOFT LADDER DIAGRAM

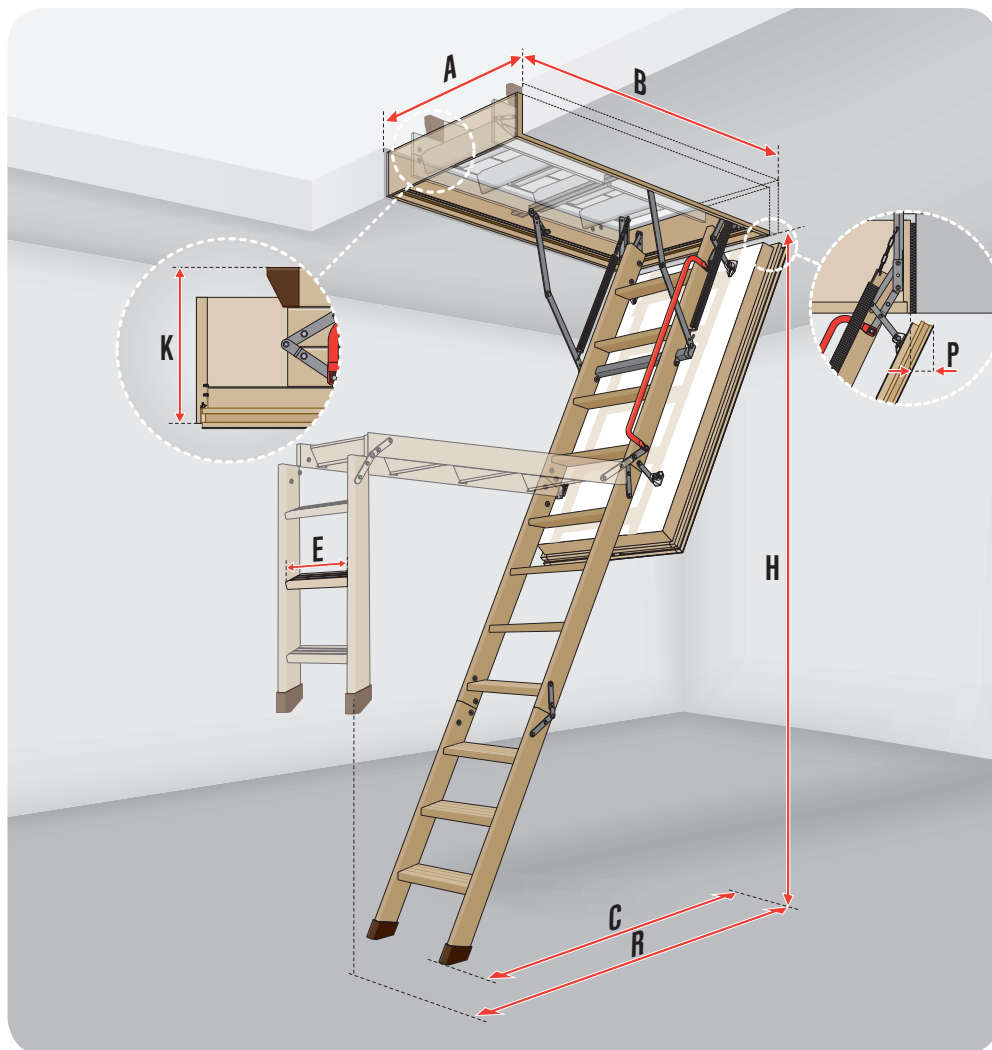

## LWT PASSIVE HOUSE LOFT LADDER DIMENSIONS

Ceiling opening dimensions [cm]	AxB	62x122	72x122	72x132	72x142	62x132	72x132	72x142
Room height [cm]	H	280				305		
Box external dimensions [cm]		58x118.4	68x118.4	68x128.4	68x138.4	58x128.4	68x128.4	68x138.4
Internal box dimensions [cm]		54x114	64x114	64x124	64x134	54x124	64x124	64x134
Folded ladder height [cm]	K	33						
Swing space [cm]	R	160				175		
Distance after ladder unfolding [cm]	C	127				135		
Hatch retraction after opening [cm]	P	65						
Box height [cm]		22						

## LADDER PARAMETERS

Tread length [cm]	E	34						
Tread width [cm]		8						
Distance between treads [cm]		25						
Tread thickness [cm]		2						

## LOFT LADDER

Commercial sizes [cm]		62x122	72x122	72x132	72x142	62x132	72x132	72x142
Room height [cm]	H	280				305		
Code								

Ladders are available only in sizes shown above.

WOODEN  
LOFT LADDERS

# LOFT LADDERS WITH WOODEN FOLDING SECTION



EN 13501-2  
**EI<sub>1</sub>45**

STANDARD  
**EN 14975**

**U=0.6\***  
W/m<sup>2</sup>K



The **LWF 45**, a new generation of fire resistant loft ladders which perfectly combines a **high level of fire protection** with comfortable and safe access to the loft. Special hatch design and materials used provide a **45-minute** protection against fire penetration from the space where the loft ladder was installed. (**EI<sub>1</sub>45/EI<sub>2</sub>45**).



Triple system of seals guarantees perfect airtightness.



Short distance between the top tread and loft floor.



Hinge of the hatch controls the hatch movement, and during the opening moves the hatch away from the ladder's treads, thus automatically increasing the space indispensable for the ladder use.



The white on both sides and insulated, the hatch is equipped with expandable seal which under the influence of heat expands and prevents entering the fire to the fire free space.

\* manufacturer's own data



stile ends



handrail



fire resistant hatch



non-slip treads set flush with ladder strings



three seals  
x3



possibility of installing additional accessories pages 52-57

Technical specification:  
**maximum load of 160 kg**  
**heat transmission coefficient U = 0.6 W/m<sup>2</sup>K**  
**Fire resistance class EI<sub>1</sub>/EI<sub>2</sub>=45min**  
**insulation thickness 7.4 cm**  
**hatch thickness 8 cm**

fully assembled,  
and ready for quick  
installation in the ceiling



**3** years  
WARRANTY



# LWF 45 LOFT LADDER DIAGRAM

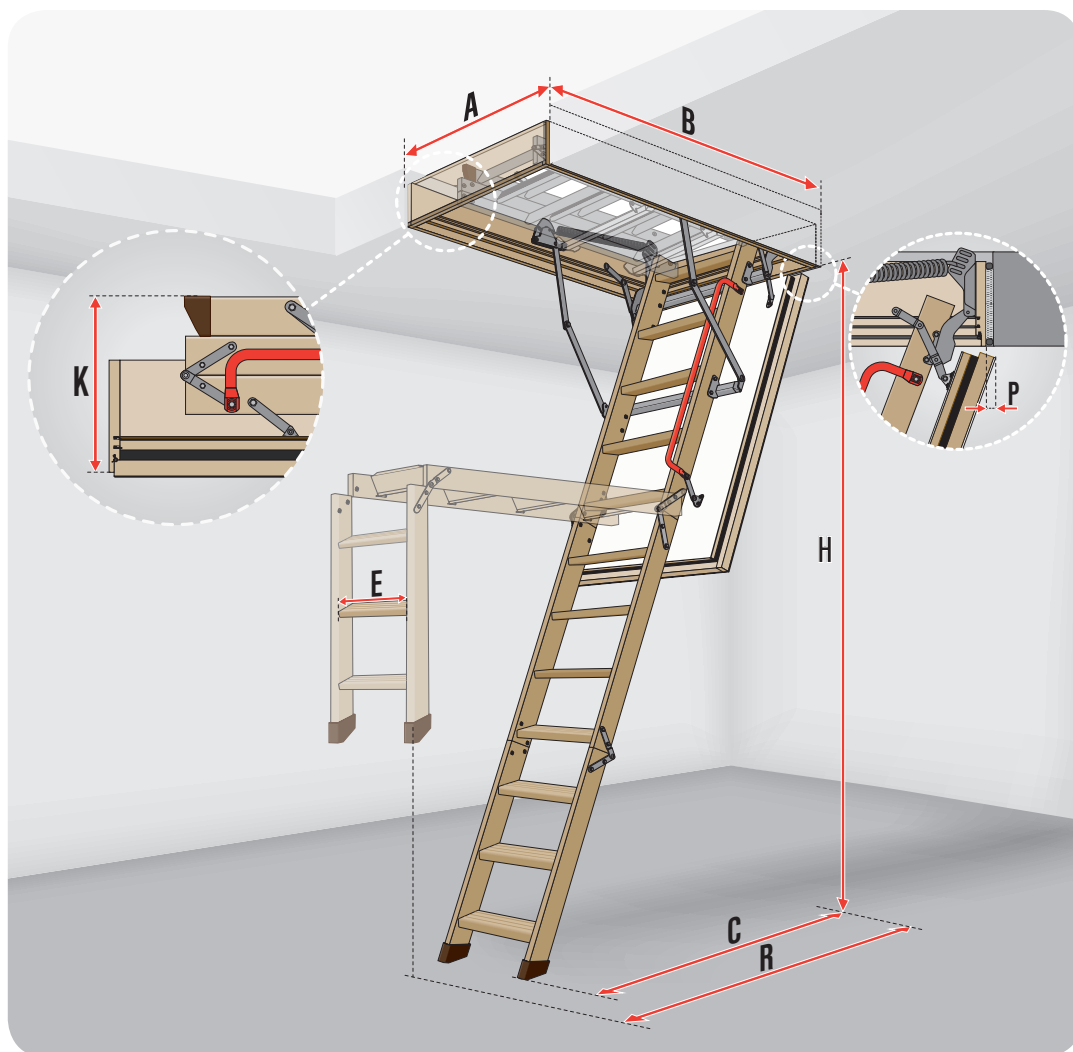

## LWF 45 LOFT LADDER DIMENSIONS

Ceiling opening dimensions [cm]	AxB	60x120	70x120	70x130	70x140	86x130	70x130	70x140	86x130	
Room height [cm]	H	280						305		
Box external dimensions [cm]		58x118	68x118	68x128	68x138	84x128	68x128	68x138	84x128	
Internal box dimensions [cm]		54x114	64x114	64x124	64x134	80x124	64x124	64x134	80x124	
Folded ladder height [cm]	K	37								
Swing space [cm]	R	164						178		
Distance after ladder unfolding [cm]	C	129						139		
Hatch retraction after opening [cm]	P	4								
Box height [cm]		22								

## LADDER PARAMETERS

Tread length [cm]	E	34								
Tread width [cm]		8								
Distance between treads [cm]		25								
Tread thickness [cm]		2								

## LOFT LADDER

Commercial sizes [cm]		60x120	70x120	70x130	70x140	86x130*	70x130	70x140	86x130*	
Room height [cm]	H	280						305		
Code		864601	864611	864612	864613	864696	864653	864654	864697	

Ladders are available only in sizes shown above.

WOODEN  
LOFT LADDERS



# SLIDING SECTION LOFT LADDERS

LDK

STANDARD  
**EN  
14975**

**U=1.1**  
W/m<sup>2</sup>K

The **LDK** loft ladder is a 2-section, sliding loft ladder. It is similar in style to folding section ladders, the main difference being that the bottom section simply slides up into the loft, eliminating the need for swing space.



The sliding ladder mechanism has a longer lower section which gives it stability.



white hatch



peripheral seal



non-slip treads with additional depth



handrail



possibility of installing additional accessories pages 52-57

Technical specification:  
**maximum load of 160 kg**  
**heat transmission coefficient U = 1.1 W/m<sup>2</sup>K**  
**insulation thickness 3 cm**  
**hatch thickness 3.6 cm**

fully assembled,  
and ready for quick  
installation in the ceiling



**3 years**  
WARRANTY

# LDK LOFT LADDER DIAGRAM

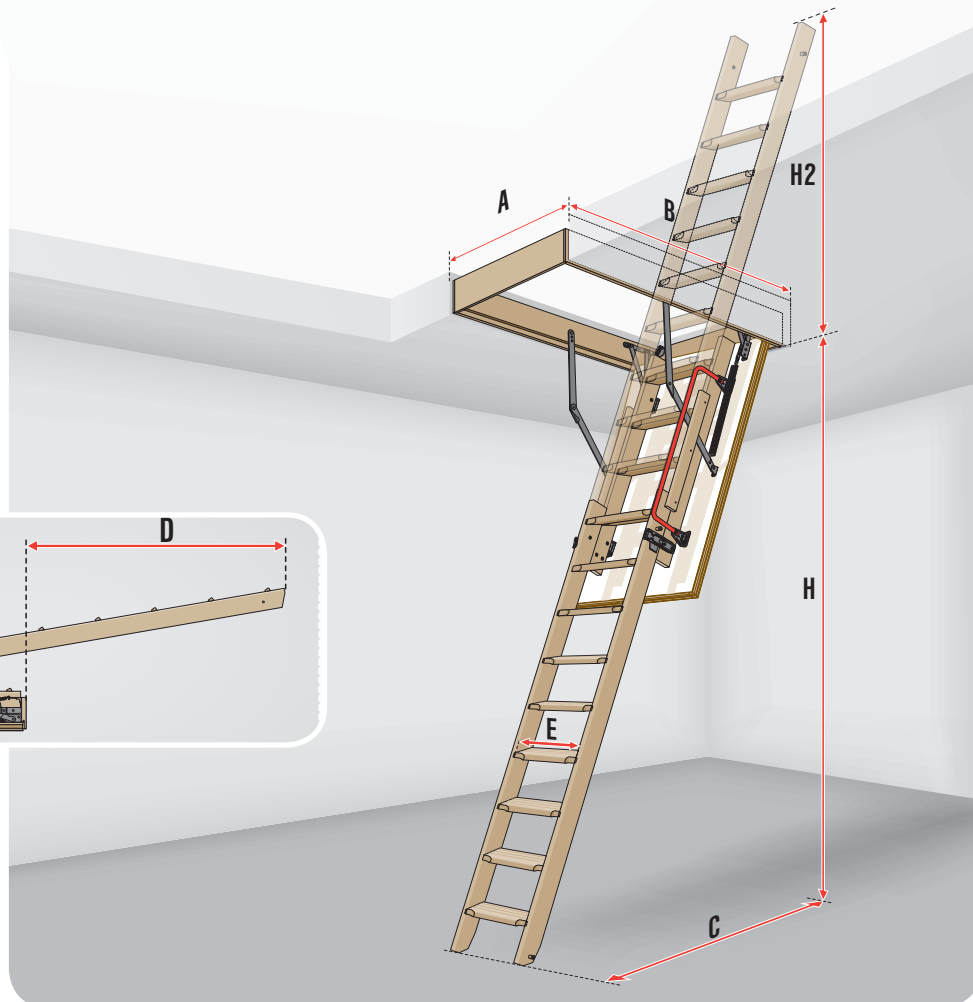
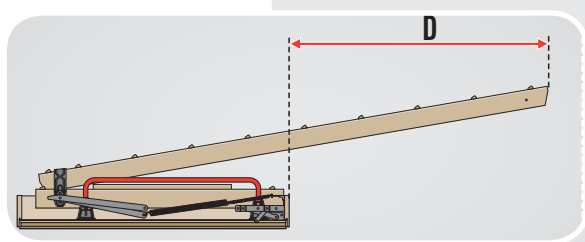

## LDK LADDER DIMENSIONS

Ceiling opening dimensions [cm]	AxB	60x120	70x120	70x130	70x140	60x120	70x120	70x130	70x140	60x120	70x120	70x130	70x140
Sliding section LDS		LDS-9				LDS-10				LDS-11			
Room height [cm]	H	280				300				335			
Box external dimensions [cm]		58x118.4	68x118.4	68x128.4	68x138.4	58x118.4	68x118.4	68x128.4	68x138.4	58x118.4	68x118.4	68x128.4	68x138.4
Internal dimensions of the box [cm]		54x114	64x114	64x124	64x134	54x114	64x114	64x124	64x134	54x114	64x114	64x124	64x134
Distance of drop [cm]	C	130				140				150			
Max height of the loft required [cm]	H2	130				155				184			
Max length of the loft required with hatch door closed	D	129				155				185			
Max thickness of the ceiling [cm]						31.5							
Box height [cm]						14							

## LADDER PARAMETERS

Tread length [cm]	E					34							
Tread width [cm]						8							
Distance between treads [cm]						25							
Tread thickness [cm]						2							

## LOFT LADDER

Commercial sizes [cm]		60x120	70x120	70x130	70x140	60x120	70x120	70x130	70x140	60x120	70x120	70x130	70x140
Room height [cm]	H	280				300				335			
Code		861001	861011	861012	861013	861001	861011	861012	861013	861001	861011	861012	861013

\* The LDK complete ladder consists of the top element and sliding section LDS, packed separately.

Ladders are available only in sizes shown above.



# NON-STANDARD LOFT LADDER SIZES

Where installation of a standard FAKRO loft ladder is not possible, bespoke timber folding sections of the LWK KOMFORT can be made.

## NON-STANDARD LOFT LADDER SIZES

### ▶ BOX

The loft ladder box is made of wood and has a peripheral seal placed within a milled recess. Once the hatch is closed, this seal ensures full airtightness is provided and once installed the box's special design enables quick and easy fitting of either a lining or architrave.

### ▶ HARDWARE

The spring catch provides added rigidity to the box, prevents distortion and ensures that the ladder will continue to be operated trouble-free. The hinges joining each section of the ladder also add strength to connections as they move.

### ▶ TREADS

Grooves which are cut into the tread surface protect the user from accidental slipping while using the ladder.

### ▶ STILE ENDS

Stile ends (for 3-section loft ladders only) made of PVC protect the floor surface from scratching and add to overall stability.

### ▶ HATCH OPENING MECHANISM

Operation of the loft ladder is significantly improved because of Fakro's unique unloading mechanism. Once unlocked, the hatch opens slowly without any potential danger to the user. Once fully opened, this mechanism will also hold the hatch in position, preventing it from slamming shut.

### ▶ HATCH

The loft ladder hatch is made of wood and can be either insulated or fire-resistant. The insulation protects against heat loss while fire-resistant material protects against heat build-up caused by spread of flame. The external hatch surface is smooth with no visible fixing points to detract from the visual style of any interior design.

### ▶ LADDER

FAKRO loft ladders are predominantly of three sections, though some have four. These are moved away from the hatch in order to create more space for the feet. The special ladder structure and materials used ensure the highest standard of durability.



When ordering the **LWK Komfort** loft ladder in non-standard sizes the actual dimensions of the ceiling opening ('A' and 'B') and the room height 'H' have to be provided.

The actual size of the loft ladder box is reduced (for installation reasons) by 2 cm in width and 1.6 cm in length, e.g. for the opening dimensions 54 x 94cm, those of the ladder would be 52 x 92.4cm. When ordering please take into account the swing space needed when unfolding (swing space 'R'), the distance once the ladder is unfolded (distance 'C') and hatch retraction after it is opened (distance 'P').

**LWK Komfort** loft ladders are equipped with a hatch which is finished in white on both sides (three section ladders only), and, with the exception of ladders for a 54cm hatch width, a handrail. The height of the loft ladder box is 14cm though to provide a neat finish with deeper ceilings an LXN box extension can be installed (see page 54).

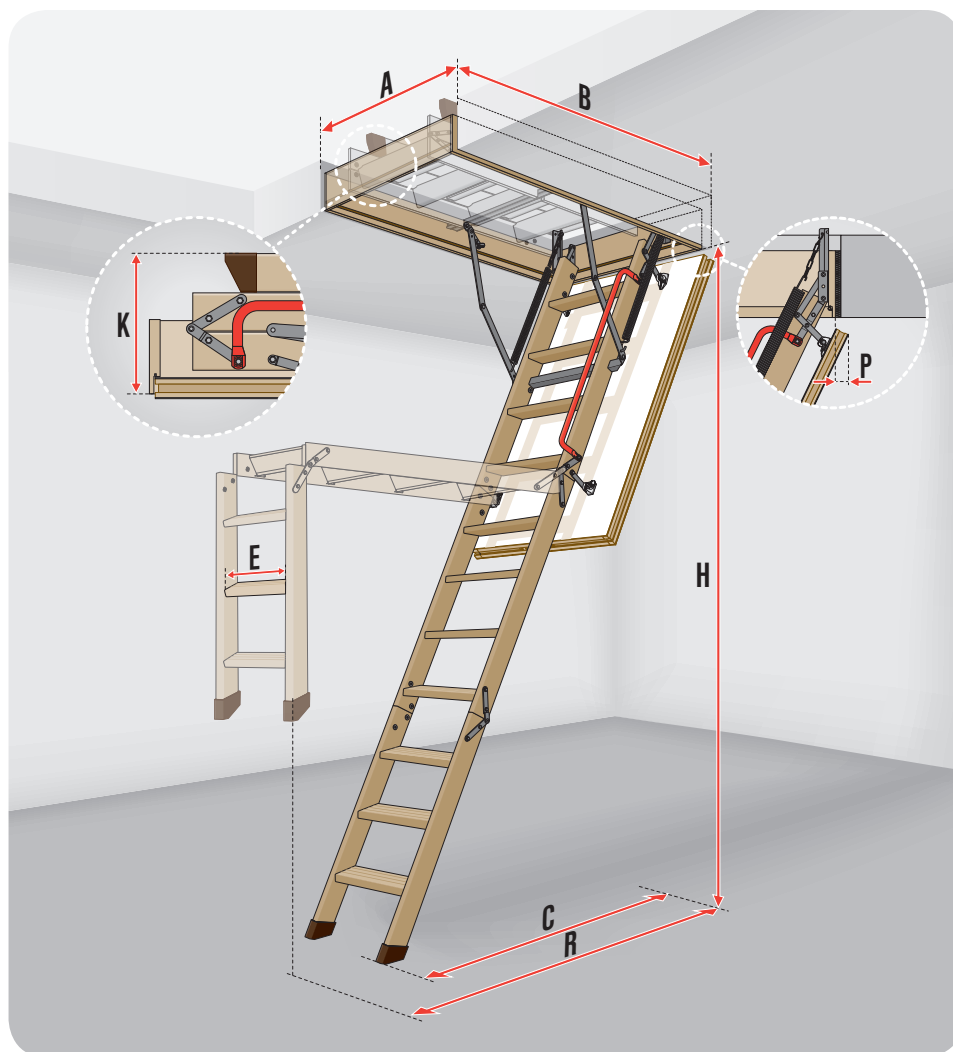

#### LOFT LADDER COMMERCIAL SIZES

Ceiling opening width [cm]	Ceiling opening length [cm]	Room height [cm]	Swing space (measured from the rear edge of the box) [cm]	Distance after ladder unfolding (measured from the rear edge of the box) [cm]	Hatch retraction after opening [cm]	Number of segments
A	B	H	R	C	P	
54 – 86	94 – 140	200 – 280	125-156	89-120	4	3 or 4
	130 – 140	280 – 305	155-175	120-135	4	3
	140	305 – 335	175-184	135-146	4	3

#### TREAD E LENGTH: 3-segment ladder

Ceiling opening width A [cm]	$54 \leq A < 58$	$58 \leq A$
Tread E length [cm]	30	34

#### 4-segment ladder

Ceiling opening width A [cm]	$54 \leq A < 56$	$56 \leq A < 60$	$60 \leq A$
Tread E length [cm]	28	30	34

**METAL SECTION**  
LOFT LADDERS



**SECTION**  
**LOFT LADDERS**



## ► BOX

The ladder box can be of wood, metal or a combination of a wooden box / metal frame. It has been designed to enable architrave to be installed with ease if the ready-fitted option is not chosen. Peripheral single or double seals provide a good standard of airtightness.

## ► HATCH UNFOLDING MECHANISM

The hatch opening mechanism enables it to be fully or partly open positions to ensure folding and unfolding are done in safety. LML and LMF loft ladders also have a hidden mechanism in the handrail which in conjunction with that of the hatch opening enables them to be opened or closed with a single rod.

## ► HARDWARE

The patented corner hinge design adds rigidity to the box and prevents distortion. This ensures that the ladder will continue to be operated trouble-free.

## ► HATCH

The loft ladder hatch is made of wood or metal and can be either insulated or fire-resistant. The insulation protects against heat loss while fire-resistant material protects against heat build-up caused by spread of flame. The external hatch surface is smooth to blend effectively with the visual style of any interior design.

## ► TREAD

Circular embossing of the tread surface prevents slipping while the width of treads (8 or 13cm) enables them to be used safely and with ease.

## ► LADDER

The special design of the metal ladder and a double connection of the ladder hinges guarantee high ladder strength. Ladder elements are powder-coated with hard wearing lacquer in grey RAL 7022 or silver RAL 9006. Some metal ladders have the final two treads left loose and with telescopic stile ends this enables adjustments of the ladder length to be made without the need for cutting.

## ► STILE ENDS

Made from plastic, these protect the floor from scratches and in addition add to the overall ladder stability.



# METAL FOLDING SECTION LOFT LADDERS



**LMS**  
SMART

STANDARD  
**EN**  
**14975**

**U=1.1**  
W/m<sup>2</sup>K

The **LMS** is a 3-section loft ladder in which the hatch and box are made of pine. The metal ladder is powder-coated in RAL 7022 while the insulated hatch is finished in beige.



The use of metal ladder with special hinge structure guarantees high durability -permissible loading 200kg.



stile ends



beige hatch



non-slip treads



peripheral seal



possibility of installing additional accessories pages 52-57

Technical specification:  
**permissible loading of 200 kg**  
**heat transmission coefficient U = 1.1 W/m<sup>2</sup>K**  
**insulation thickness 3 cm**  
**hatch thickness 3.6 cm**

fully assembled,  
and ready for quick  
installation in the ceiling



**3** years  
WARRANTY

# LMS LOFT LADDER DIAGRAM

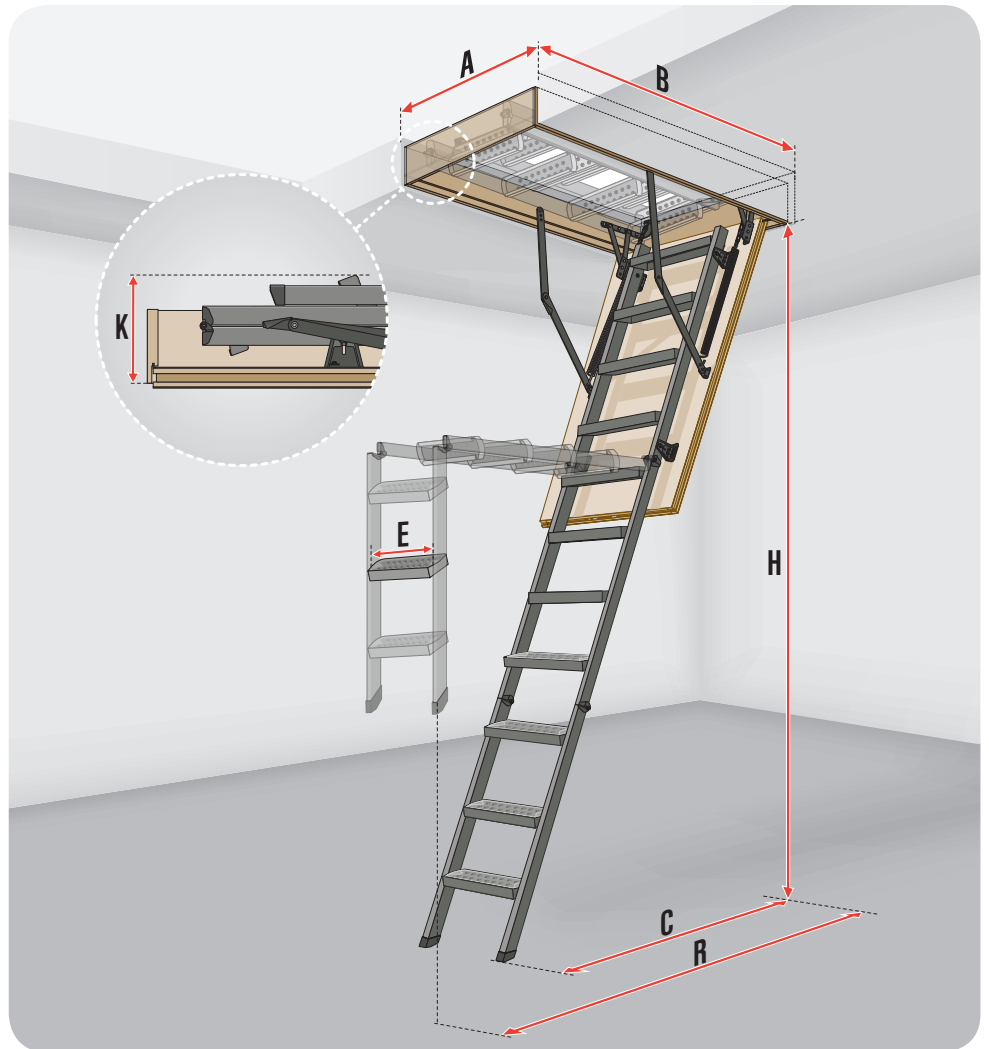







## LMS LOFT LADDER DIMENSIONS

Ceiling opening dimensions [cm]	AxB	60x120	70x120	70x130	70x140	60x130	70x130	70x140
Room height [cm]	H	280				305		
Box external dimensions [cm]		58x118.4	68x118.4	68x128.4	68x138.4	68x128.4	68x128.4	68x138.4
Internal box dimensions [cm]		54x114	64x114	64x124	64x134	54x124	64x124	64x134
Folded ladder height [cm]	K	25,5						
Swing space [cm]	R	157				175		
Distance after ladder unfolding [cm]	C	118,5				127		
Box height [cm]		14						

## LADDER PARAMETERS

Tread length [cm]	E	34						
Tread width [cm]		8						
Distance between treads [cm]		25						

## LOFT LADDER

Commercial sizes [cm]		60x120	70x120	70x130	70x140	60x130	70x130	70x140
								
Room height [cm]	H	280				305		
Code		<b>861201</b>	<b>861211</b>	<b>861212</b>	<b>861213</b>	<b>861251</b>	<b>861253</b>	<b>861254</b>

Ladders are available only in sizes shown above.

METAL  
LOFT LADDERS

# METAL FOLDING SECTION LOFT LADDERS

**LMK**  
KOMFORT

STANDARD  
**EN  
14975**

**U=1.1**  
W/m<sup>2</sup>K

Unlike the LMS the **LMK** loft ladder has a white hatch and red handrail. The handrail is fixed to the ladder brackets, making its use much easier.



White insulated hatch and handrail



stile ends



handrail



white hatch



non-slip treads



peripheral seal



possibility of installing additional accessories pages 52-57

Technical specification:  
**permissible loading of 200 kg**  
**heat transmission coefficient  $U = 1.1 \text{ W/m}^2\text{K}$**   
**insulation thickness 3 cm**  
**hatch thickness 3.6 cm**

fully assembled,  
and ready for quick  
installation in the ceiling



**3 years**  
WARRANTY

# LMK LOFT LADDER DIAGRAM

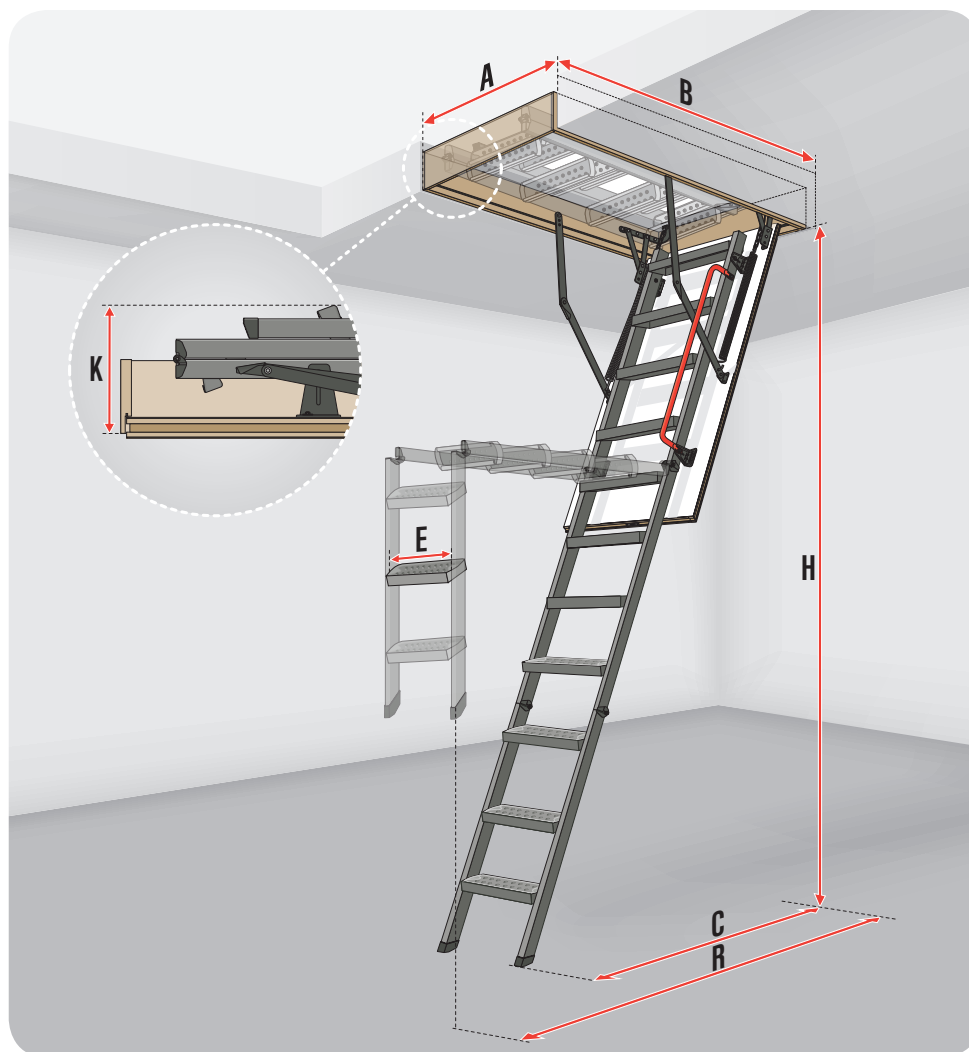

## LMK LOFT LADDER DIMENSIONS

Ceiling opening dimensions [cm]	AxB	60x120	70x120	70x130	70x140	60x130	70x130	70x140
Room height [cm]	H	280				305		
Box external dimensions [cm]		58x118.4	68x118.4	68x128.4	68x138.4	68x128.4	68x128.4	68x138.4
Internal box dimensions [cm]		54x114	64x114	64x124	64x134	54x124	64x124	64x134
Folded ladder height [cm]	K	25,5						
Swing space [cm]	R	157				175		
Distance after ladder unfolding [cm]	C	118,5				127		
Box height [cm]		14						

## LADDER PARAMETERS

Tread length [cm]	E	34						
Tread width [cm]		8						
Distance between treads [cm]		25						

## LOFT LADDER

Commercial sizes [cm]		60x120	70x120	70x130	70x140	60x130	70x130	70x140
Room height [cm]	H	280				305		
Code		861401	861411	861412	861413	861451	861453	861454

Ladders are available only in sizes shown above.



METAL  
LOFT LADDERS



# METAL FOLDING SECTION LOFT LADDERS

**LML**  
LUX



Steel frame integrated with a wooden box, metal architrave lining and quick fit brackets.



Mechanism hidden within the rail aids folding and unfolding of the ladder.



Additional tread shortens distance between top tread and loft floor.



Telescopic stile ends enable quick adjustment of ladder length to suit ceiling height.

STANDARD  
**EN  
14975**

**U=1.1**  
W/m<sup>2</sup>K

The **LML** folding section metal loft ladder has been designed to provide the highest standard of ease and convenience while offering simple assembly and height adjustment.



telescopic stile ends



ladder unloading mechanism built in handrail



white hatch



system of quick installation in the ceiling



finishing lining slats



non-slip treads, 13cm in width



peripheral seal



possibility of installing additional accessories pages 52-57

Technical specification:  
**permissible loading of 200 kg**  
**heat transmission coefficient U = 1.1 W/m<sup>2</sup>K**  
**insulation thickness 3 cm**  
**hatch thickness 3.6 cm**

fully assembled,  
and ready for quick  
installation in the ceiling



**3 years**  
WARRANTY

# LML LUX LOFT LADDER DIAGRAM



## LML LUX LOFT LADDER DIMENSIONS

Ceiling opening dimensions [cm]	AxB	60x120	70x120	70x130	70x140	60x130	70x130	70x140
Room height [cm]	H	280				305		
Box external dimensions [cm]		59.6x118.6	68.6x118.6	68.6x128.6	68.6x138.6	59.6x128.6	68.6x128.6	68.6x138.6
Internal box dimensions [cm]		55x114	64x114	64x124	64x134	55x124	64x124	64x134
Folded ladder height [cm]	K	31,5						
Swing space [cm]	R	165			176			
Distance after ladder unfolding [cm]	C	120			130			
Box height [cm]		31,5						

## LADDER PARAMETERS

Tread length [cm]	E	35						
Tread width [cm]		13						
Distance between treads [cm]		25						

## LOFT LADDER

Commercial sizes [cm]		60x120	70x120	70x130	70x140	60x130	70x130	70x140
Room height [cm]	H	280				305		
Code		862401	862411	862412	862413	862451	862453	862454

Ladders are available only in sizes shown above.

# FIRE-RESISTANT LOFT LADDERS



EN 13501-2  
**EI<sub>2</sub> 120**

STANDARD  
**EN 14975**

**U=0.79\***  
W/m<sup>2</sup>K

The design of **LMF** loft ladder complies with stringent fire requirements, whilst providing safe and comfortable access to the loft spaces. The LMF ladder prevents fire from spreading to the upper or lower fire free storey for **120 minutes**.

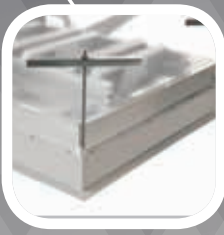

Integrated with steel frame the quick installation system reduces time required to settle loft ladder in the ceiling.



Short distance between the last tread and attic floor.



The special hatch design and materials used in its production protect for 120 min against the ingress of fire.



Mechanism hidden within the rail aids folding and unfolding of the ladder.

\* manufacturer's own data



telescopic stile ends



ladder unloading mechanism built in handrail



fire-resistant hatch



system of quick installation in the ceiling



architrave lining



non-slip treads, 13 cm in width



seal



possibility of installing additional accessories pages 52-57

Technical specification:  
**permissible loading of 200 kg**  
**fire-resistance EI<sub>2</sub> = 120 minutes**  
**insulation thickness 8 cm**  
**hatch thickness 8.2 cm**

fully assembled,  
and ready for quick  
installation in the ceiling



**3 years**  
WARRANTY

# LMF LOFT LADDER DIAGRAM

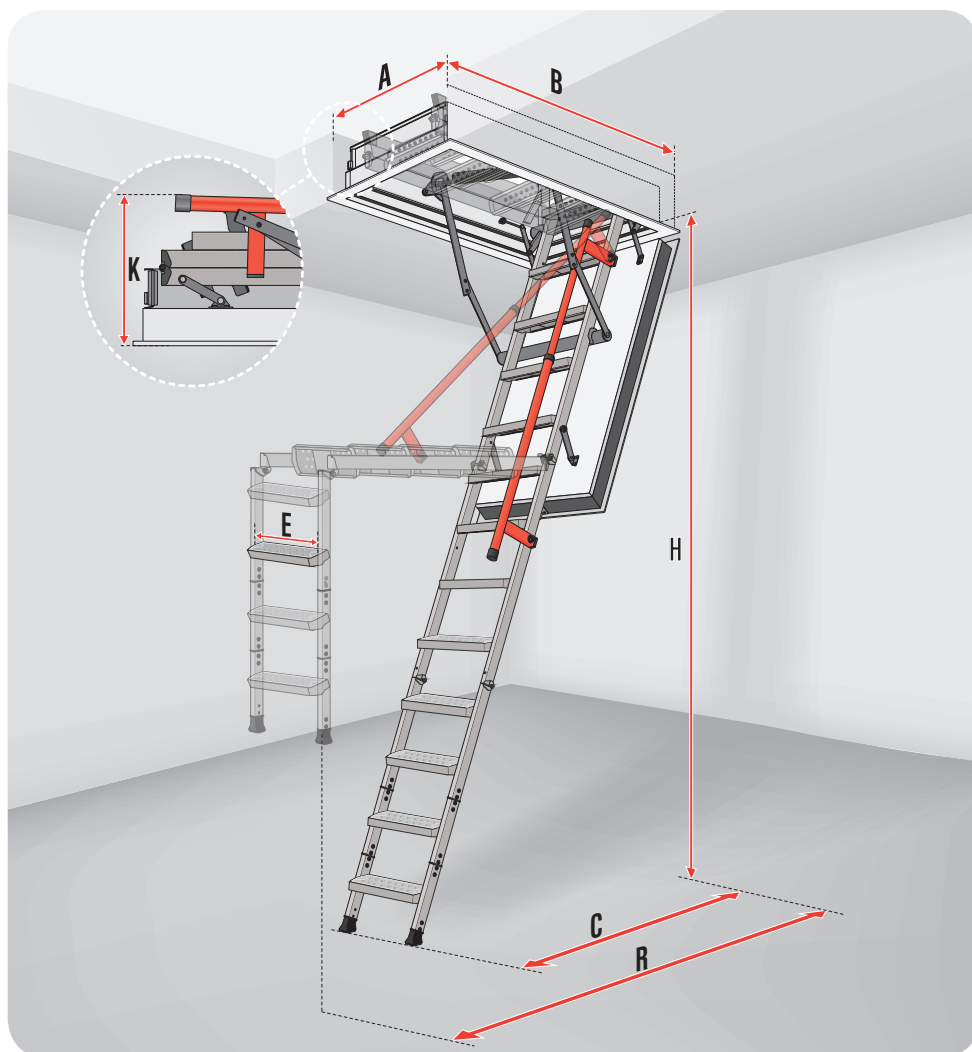

## LMF LOFT LADDER DIMENSIONS

Ceiling opening dimensions [cm]	AxB	60x120	70x120	70x130	70x140	86x130	70x130	70x140	86x130	
Room height [cm]	H	280						305		
Box external dimensions [cm]		59x118	68x118	68x128	68x138	84x128	68x128	68x138	84x128	
Internal box dimensions [cm]		55x114	64x114	64x124	64x134	80x124	64x124	64x134	80x124	
Folded ladder height [cm]	K	34								
Swing space [cm]	R	165						176		
Distance after ladder unfolding [cm]	C	120						130		
Box height [cm]		16								

## LADDER PARAMETERS

Tread length [cm]	E	35							
Tread width [cm]		13							
Distance between treads [cm]		25							

## LOFT LADDER

Commercial sizes [cm]		60x120	70x120	70x130	70x140	86x130	70x130	70x140	86x130	
Room height [cm]	H	280						305		
Code		862501	862511	862512	862513	862596	862553	862554	862597	

Ladders are available only in sizes shown above.



SCISSORS LOFT  
LADDERS



SCISSORS  
LOFT LADDERS

## ► BOX

The ladder box can be of wood, metal or a combination of a wooden box / metal frame. The box is equipped with a **peripheral seal** and **lining as standard**. The box enables the scissors ladder to be installed and adjusted quickly and with ease.

## ► HATCH UNLOADING MECHANISM

The hinge mechanism significantly simplifies ladder operation. Once unlocked, the hatch opens slowly to avoid any risk to the user. It then keeps the hatch in the fully open position and prevents spontaneous spring back during folding and unfolding.

## ► HARDWARE

The patented **corner hinge** design adds rigidity to the box and prevents distortion. This ensures that the ladder will continue to be operated trouble-free.

## ► HATCH

Scissors loft ladders are equipped with white **insulated** or **fire-resistant** hatches, made of either wood or wood and metal as standard. The external hatch surface is smooth to blend effectively with the visual style of any interior design.

## ► TREADS

The **specially embossed** pattern on the tread surface protects the user from accidental slipping while using the loft ladder.

## ► LADDER

The scissors ladder construction makes height adjustment a simple process **with no need for cutting**. It also enables the ladder to be folded to a smaller size and used in openings as small as 50 x 70cm. The elegant, modern style is achieved through use of 'S'-shaped stringers which can also be used as handrails.



SCISSORS  
LOFT LADDERS

# SCISSORS LOFT LADDERS

LST

STANDARD  
**EN  
14975**

**U=1.1**  
W/m<sup>2</sup>K

The **LST** scissors loft ladder is equipped with a 3.6cm thick, white insulated hatch as standard. The box is made of wood and has quick-fit brackets while the hatch opening mechanism guarantees safe folding and unfolding. In addition, its construction has eliminated the need for a lock. The ladder itself is powder-coated in RAL 7022 Grey. The overall floor - ceiling ladder height can be increased to a maximum of 330cm by adding two LSS treads.



Wooden box with metal architrave lining and quick-fit brackets.



white hatch



possibility of adding or detaching tread



architrave lining



system of quick installation in the ceiling



peripheral seal



system of adapting the ladder length to the ceiling height



non-slip treads



possibility of installing additional accessories

Technical specification:  
**permissible loading of 200 kg**  
**heat transmission coefficient U = 1.1 W/m<sup>2</sup>K**  
**insulation thickness 3 cm**  
**hatch thickness 3.6 cm**

fully assembled,  
and ready for quick  
installation in the ceiling



**3 years**  
WARRANTY

# LST LOFT LADDER DIAGRAM

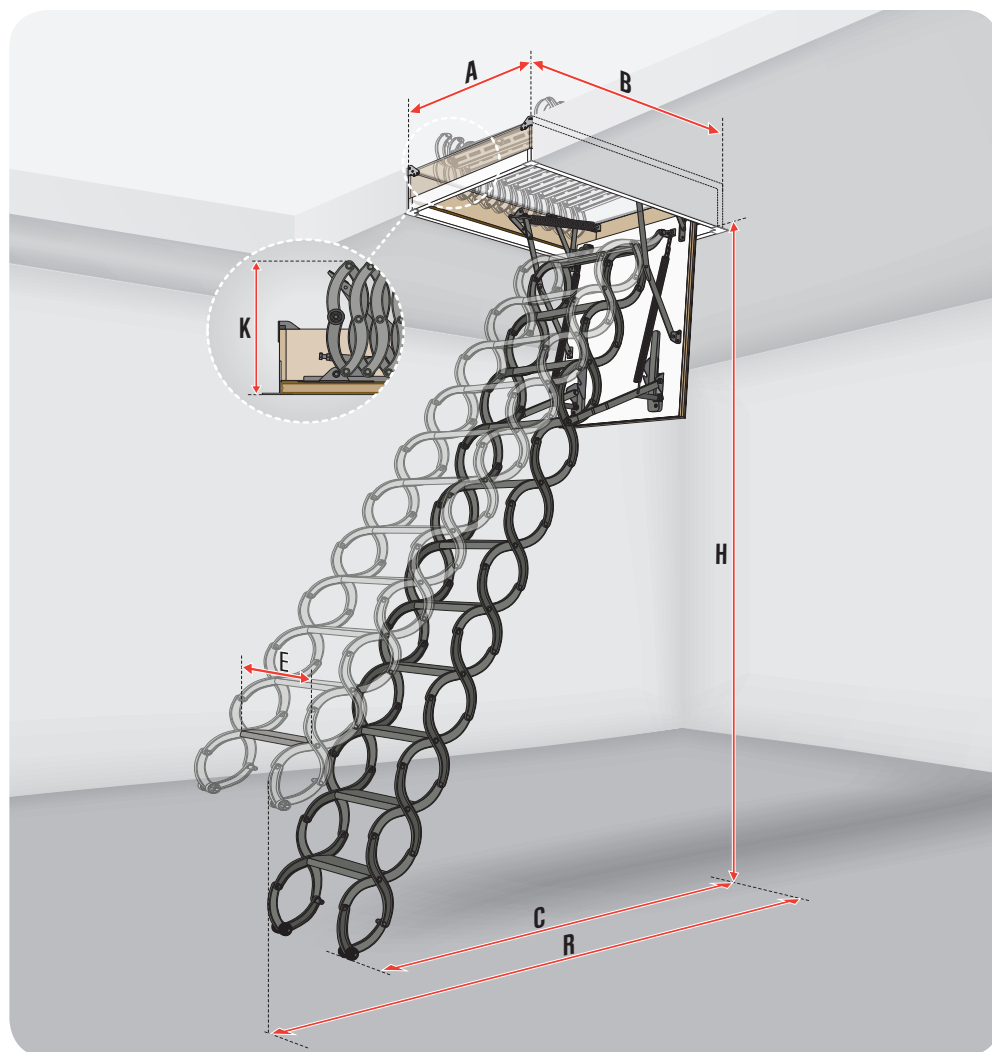

## LST LOFT LADDER DIMENSIONS

		Standard ladder length				
Ceiling opening dimensions [cm]	<b>AxB</b>	51x80	60x90	60x120	70x80	70x120
Room height [cm]	<b>H</b>	250–280				
Box external dimensions [cm]		51x79.4	59x89.4	59x119.4	69x79.4	69x119.4
Internal box dimensions [cm]		46x74	54x84	54x114	64x74	64x114
Folded ladder height [cm]	<b>K</b>	38,2				
Swing space [cm]	<b>R</b>	150				
Distance after ladder unfolding [cm]	<b>C</b>	146–134				
Box height [cm]		18				

## LADDER PARAMETERS

Tread length [cm]	<b>E</b>	26	30	38
Tread width [cm]		8		
Distance between treads [cm]		24-26		
Standard number of treads [units]		11		
Compatible tread LSS		LSS-26	LSS-31	LSS-38

## LOFT LADDER

Commercial sizes [cm]		51x80	60x90	60x120	70x80	70x120
Room height [cm]	<b>H</b>	250–280				
Code		<b>860402</b>	<b>860432</b>	<b>860423</b>	<b>860426</b>	<b>860436</b>

Ladder shorter by 1 tread (10-tread ladder)	Standard ladder (11-tread ladder)	Ladder longer by 1 tread (12-tread ladder)	Ladder longer by 2 treads (13-tread ladder)
230	250	250	280
		280	300
		300	330
Sizes and dimensions of loft ladder not included into the table are identical with those for heights 250-280cm			
	140	150	160
	170		
135	127	146	134
		153	145
		163	150

Code	860204	860205	860206
tread*	LSS-26	LSS-31	LSS-38
ladder width [cm]	51	60	70

Ladders are available only in sizes shown above.

\* while ordering LSS tread- the ladder commercial size and type has to be provided



SCISSORS  
LOFT LADDERS

# SCISSORS LOFT LADDERS



## LSZ

STANDARD  
**EN  
14975**

**U=1.1**  
W/m<sup>2</sup>K

The **LSZ** loft ladder is the same as the LST except for the box, the construction of which consists of an integrated metal frame within the wooden box. It also has finishing slats and quick-fit brackets. The overall floor - ceiling ladder height can be increased to a maximum of 330cm by adding two LSS treads.



Metal frame integrated with wooden box plus lining and quick-fit brackets.



white hatch



possibility of adding or detaching tread



finishing lining slats



system of quick installation in the ceiling



peripheral seal



system of adapting the ladder length to the ceiling height



non-slip treads



possibility of installing additional accessories pages 52-57

Technical specification:  
**permissible loading of 200 kg**  
**heat transmission coefficient  $U = 1.1 \text{ W/m}^2\text{K}$**   
**insulation thickness 3 cm**  
**hatch thickness 3.6 cm**

fully assembled,  
and ready for quick  
installation in the ceiling



**3 years**  
WARRANTY

# LSZ LOFT LADDER DIAGRAM

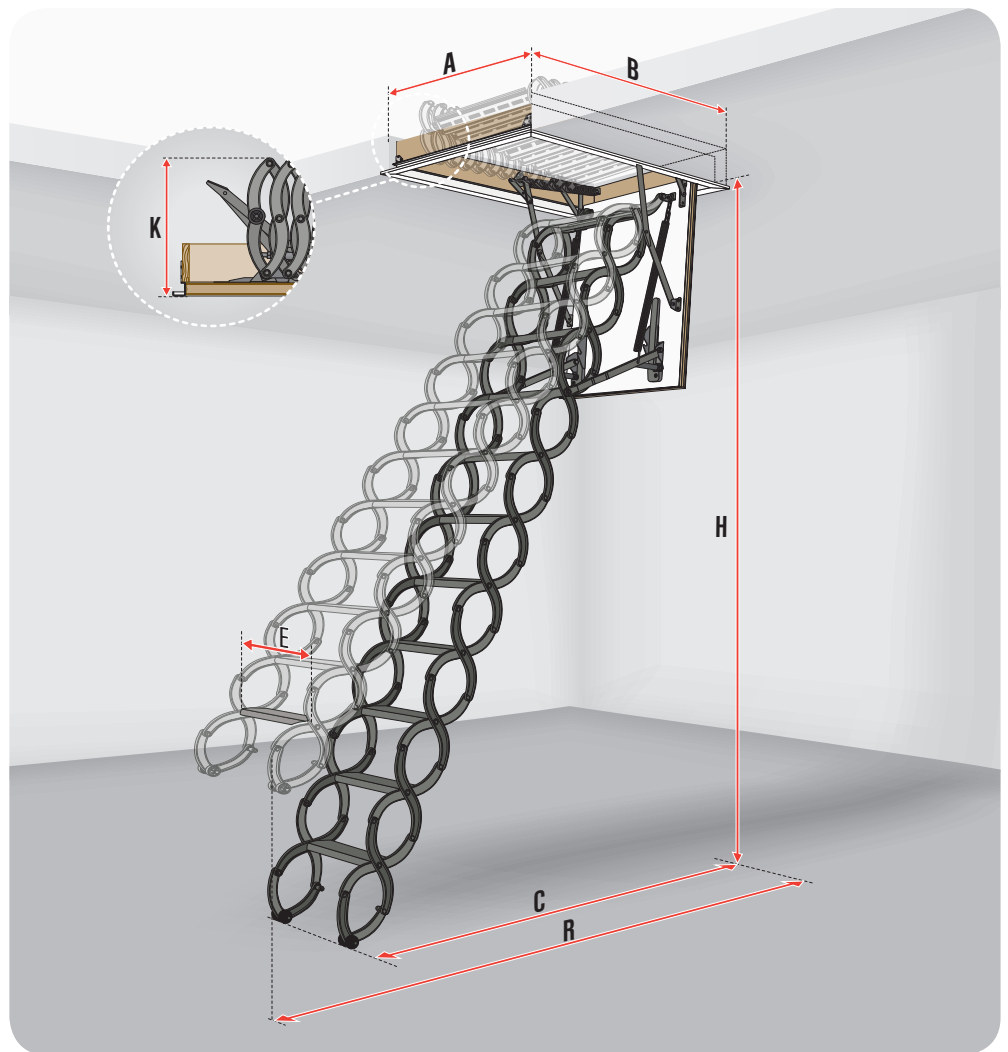

## LSZ LOFT LADDER DIMENSIONS

		Standard ladder length		
Ceiling opening dimensions [cm]	<b>AxB</b>	51x80	70x80	70x120
Room height [cm]	<b>H</b>	250 – 280		
Box external dimensions [cm]		51x79.4	69x79.4	69x119.4
Internal box dimensions [cm]		46x74	64.8x74	64.8x114
Folded ladder height [cm]	<b>K</b>	38,5		
Swing space [cm]	<b>R</b>	150		
Distance after ladder unfolding [cm]	<b>C</b>	146 – 134		
Box height [cm]		14		

## LADDER PARAMETERS

Tread length [cm]	<b>E</b>	26	38
Tread width [cm]		8	
Distance between treads [cm]		24-26	
Standard number of treads [units]		11	
Compatible tread LSS		LSS-26	LSS-38

## LOFT LADDER

Commercial sizes [cm]		51x80	70x80	70x120
Room height [cm]	<b>H</b>	250 – 280		
Code		<b>860502</b>	<b>860532</b>	<b>860536</b>

Ladder shorter by 1 tread (10-tread ladder)		Standard ladder (11-tread ladder)		Ladder longer by 1 tread (12-tread ladder)		Ladder longer by 1 tread (12-tread ladder)	
230	250	250	280	280	300	300	330
Sizes and dimensions of loft ladder not included into the table are identical with those for heights 250-280cm							
140		150		160		170	
135	127	146	134	153	145	163	150

Code	<b>860204</b>	<b>860206</b>
tread*	LSS-26	LSS-38
ladder width [cm]	51	70

Ladders are available only in sizes shown above.

\* while ordering LSS tread- the ladder commercial size and type has to be provided

METAL SCISSORS  
LOFT LADDERS

# SCISSORS LOFT LADDERS



EN 13501-2  
**EI<sub>2</sub> 60**

STANDARD  
**EN 14975**

**U=1.8\***  
W/m<sup>2</sup>K

➤ The **LSF** fire-resistant loft ladder has a 60-minute fire rating and acts as a barrier to prevent spread of flame. The overall floor - ceiling ladder height can be increased to a maximum of 320cm by adding one LSS tread.

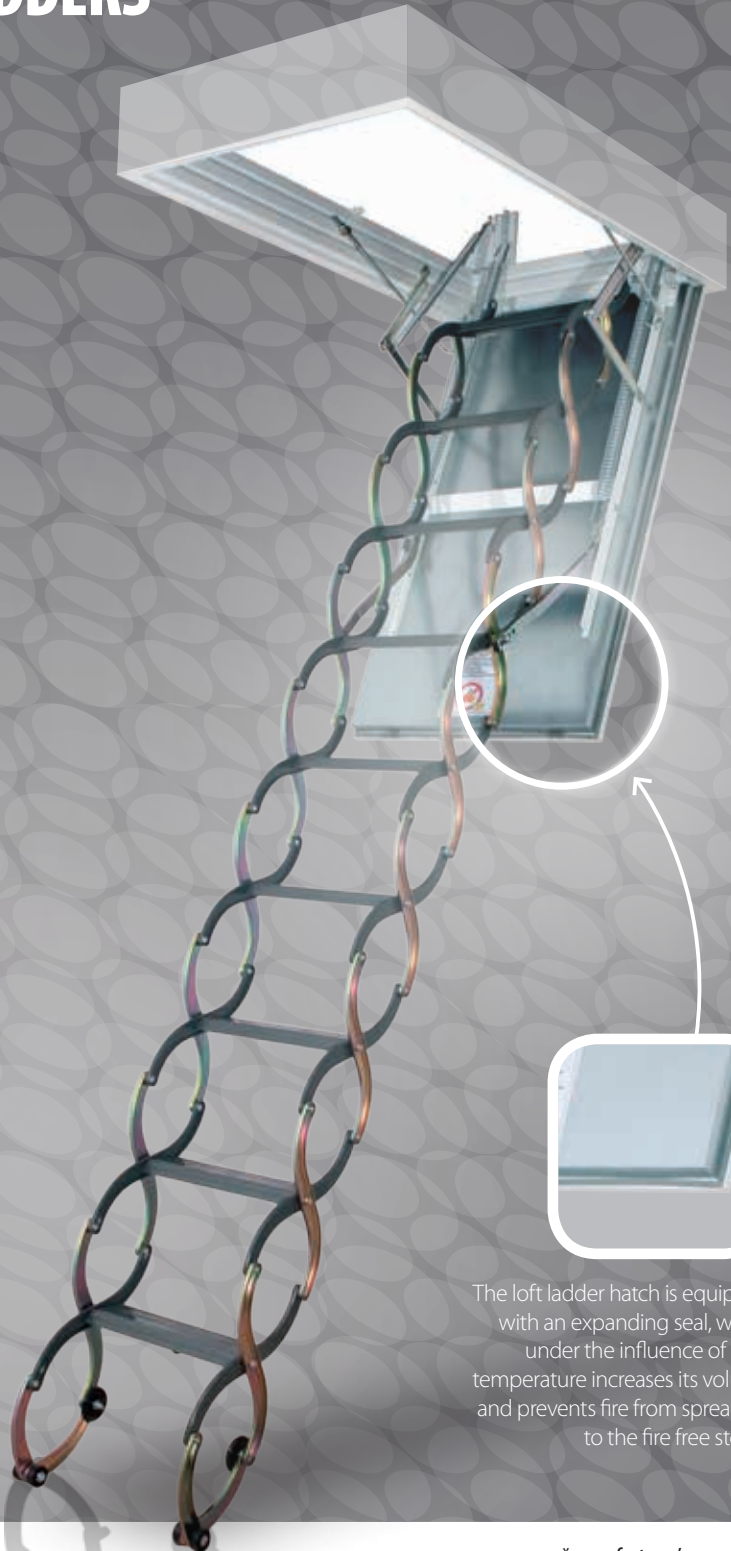

The loft ladder hatch is equipped with an expanding seal, which under the influence of high temperature increases its volume and prevents fire from spreading to the fire free storey.

\*manufacturer's own data

 fire-resistant hatch

 system of quick installation in the ceiling

 architrave lining

 system of adapting the ladder length to the ceiling height

 non-slip treads

 possibility of installing additional accessories pages 52-57

 possibility of adding or detaching tread

Technical specification:  
**permissible loading of 200 kg**  
**fire-resistance EI<sub>2</sub>=60 minutes**  
**insulation thickness 3 cm**  
**hatch thickness 5.4 cm**

fully assembled,  
and ready for quick  
installation in the ceiling



**3 years**  
WARRANTY

# LSF LOFT LADDER DIAGRAM

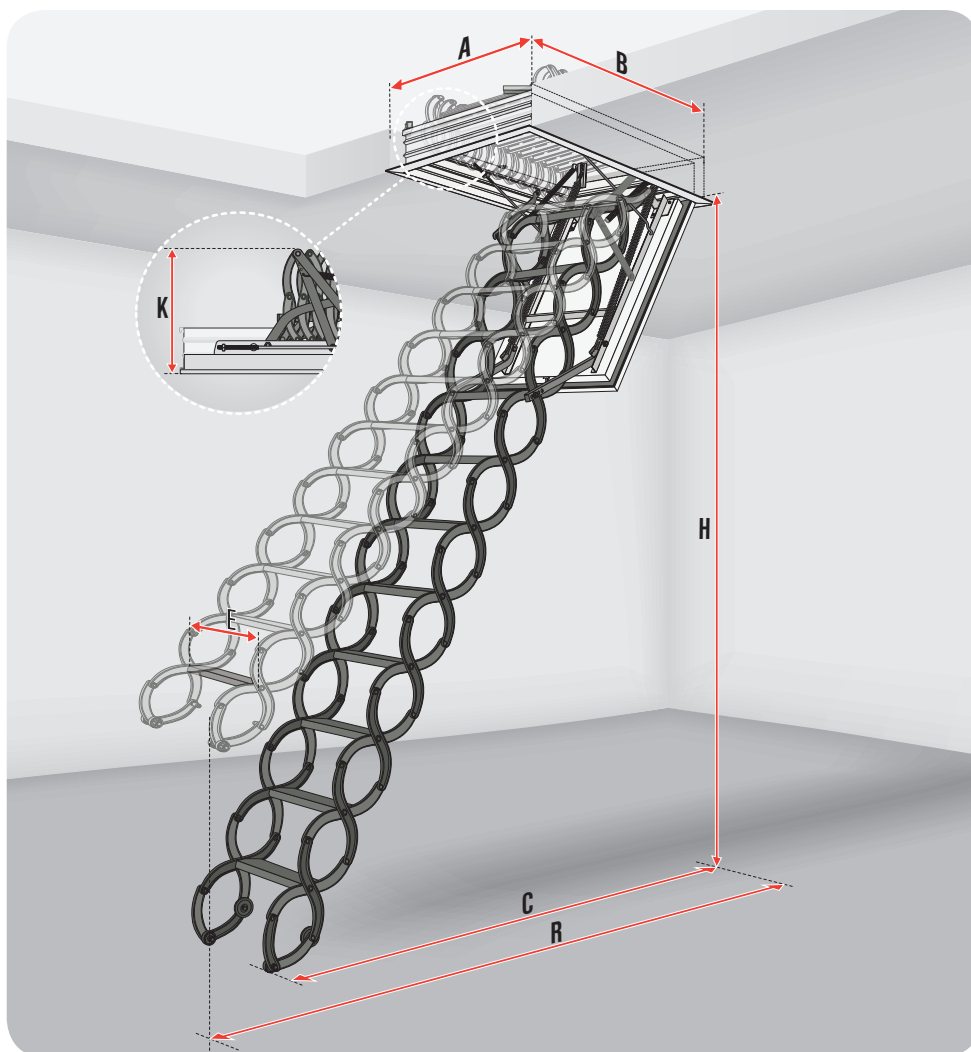

## LSF LOFT LADDER DIMENSIONS

		Standard ladder length						
Ceiling opening dimensions [cm]	AxB	50x70	60x90	60x120	70x80	70x90	70x110	70x120
Room height [cm]	H	270 – 300						
Box external dimensions [cm]		48x68.5	58x88.5	58x118.5	68x78.5	68x88.5	68x108.5	68x118.5
Internal box dimensions [cm]		44.8x64.8	54.8x84.8	54.8x114.8	64.8x74.8	64.8x84.8	64.8x104.8	64.8x114.8
Folded ladder height [cm]	K	46						
Swing space [cm]	R	170 – 180						
Distance after ladder unfolding [cm]	C	165 – 130						
Box height [cm]		14						

## LADDER PARAMETERS

Tread length [cm]	E	30	32	40
Tread width [cm]		8		
Distance between treads [cm]		25 – 30		
Standard number of treads [units]		10		
Compatible tread LSS		LSS-30	LSS-32	LSS-40

## LOFT LADDER

Commercial sizes [cm]	50x70	60x90	60x120	70x80	70x90	70x110	70x120
Room height [cm]	270 – 300						
Code	860101	860123	860126	860132	860133	860135	860136

Ladder shorter by 1 tread (9-tread ladder)		Standard ladder (10-tread ladder)		Ladder longer by 1 tread (11-tread ladder)	
240	270	270	300	300	320
Sizes and dimensions of loft ladder not included into the table are identical with those for heights 250-280cm					
165	165	170	180	185	210
100	140	165	130	120	140

Code	860201	860202	860203
tread*	LSS-30	LSS-32	LSS-40
ladder width [cm]	50	60	70

Ladders are available only in sizes shown above.

\* when ordering LSS tread- the ladder commercial size and type has to be provided





# L-SHAPED COMBINATION DOORS

**DWK** L-Shaped combination doors are intended to be built into walls to provide access to the unused space behind. They offer excellent thermal insulation parameters ( $U=1.1W/m^2K$ ) and airtightness to minimise heat loss. Left or right-hand opening versions are available, standard doors being equipped with 3.5cm wide natural timber-coloured slats. The 3.6cm insulated sash is of HDF and has a white veneer on both sides and pine frame.

**DWK**

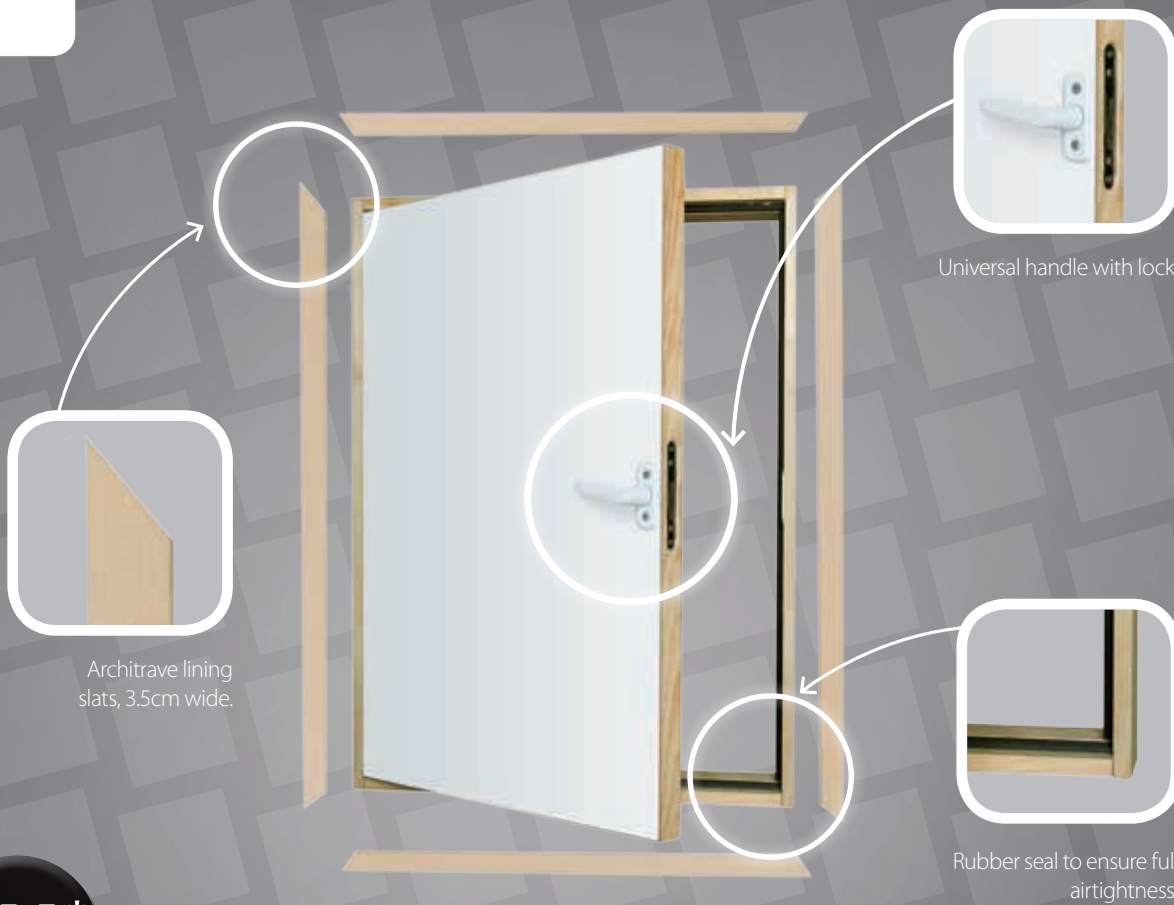

**$U=1.1^*$**   
 **$W/m^2K$**

\*manufacturer's own data



architrave lining



Technical specification:  
**heat transmission coefficient  $U = 1.1 W/m^2K$**   
**insulation thickness 3 cm**

fully assembled,  
and ready for quick  
installation in the ceiling



**3 years**  
**WARRANTY**

# DWK DOOR DIAGRAM

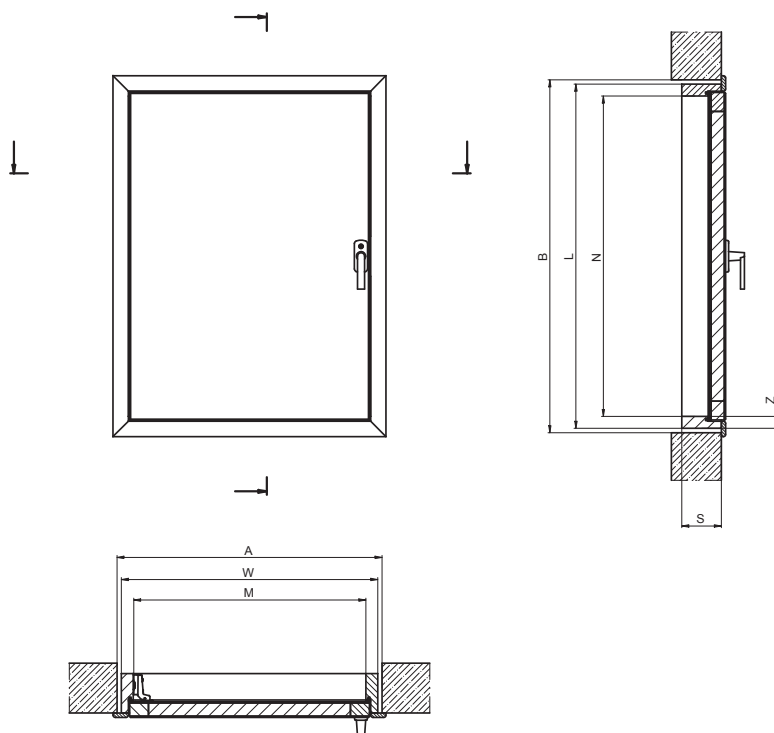

## DWK L-SHAPED DOORS DIMENSIONS

Opening dimensions [cm]	AxB	55x80	60x80	60x100	60x110	70x90	70x100	70x110
Door dimensions [cm]	WxL	53.4x78.4	58.4x78.4	58.4x98.4	58.4x108.4	68.4x88.4	68.4x98.4	68.4x108.4
Frame internal dimensions [cm]	MxN	48x73	53x73	53x93	53x103	63x83	63x93	63x103
Frame width [cm]	S	9						
Frame thickness [cm]	Z	2,7						

## L-SHAPED DOORS

Commercial sizes [cm]	55x80	60x80	60x100	60x110	70x90	70x100	70x110
Code	869900	869922	869924	869925	869933	869934	869935

DWK doors are available only in sizes shown above.

WOODEN  
DOORS



# HIGHLY ENERGY-EFFICIENT WOODEN DOORS

The **DWT** highly energy efficient L-shaped doors are designed primarily for installation in L-shaped walls, provide access to the room behind and at the same time constitute an excellent barrier against heat loss (heat transfer coefficient  $U = 0.6 \text{ W} / \text{m}^2\text{K}^*$ ) and guarantee high tightness. The door can be installed in the right or left side. They are standard equipped with wooden architrave lining in natural colour.

**DWT**  
HIGHLY ENERGY  
EFFICIENT

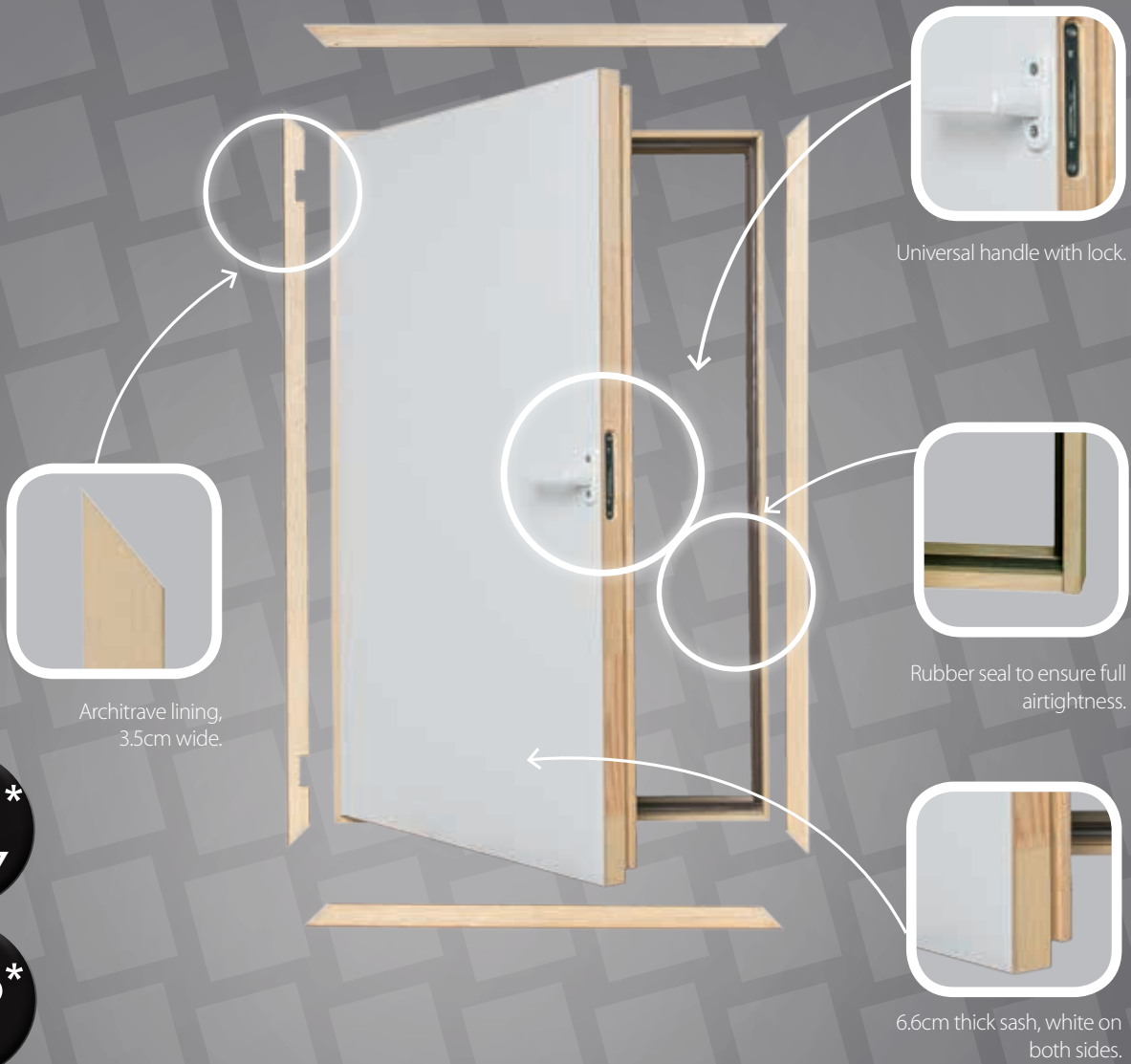

**4** CLASS\*  
EN12207

**U=0.6**\*  
W/m<sup>2</sup>K

\*manufacturer's own data



architrave lining



Technical specification:  
**heat transmission coefficient  $U = 0.6 \text{ W} / \text{m}^2\text{K}$**   
**insulation thickness 6 cm**

fully assembled,  
and ready for quick  
installation in the ceiling



**3** years  
WARRANTY

# DWT DOOR DIAGRAM

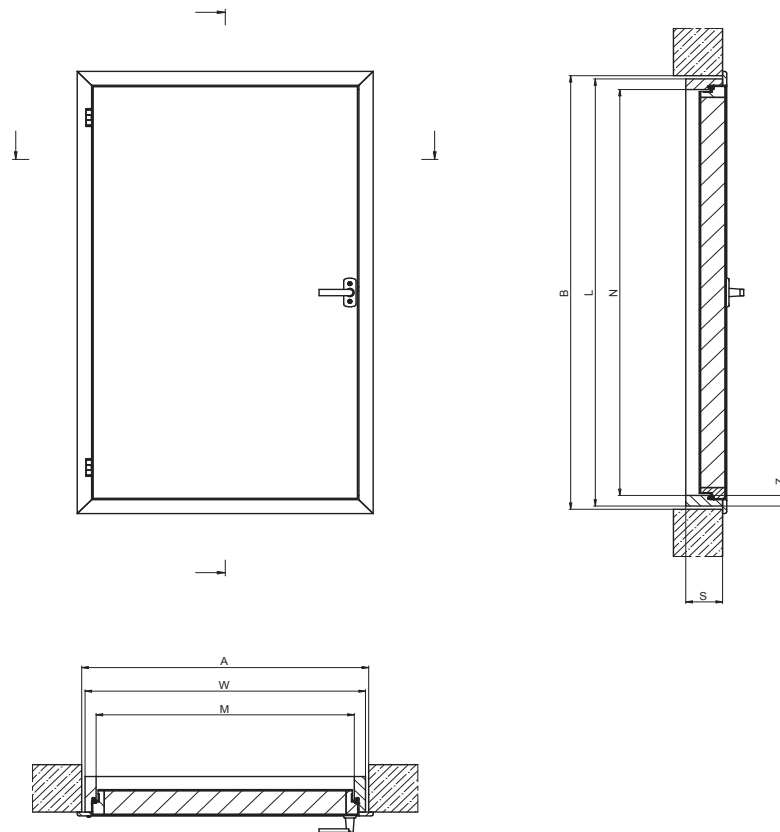

## DWT L-SHAPED DOORS DIMENSIONS

Opening dimensions [cm]	<b>AxB</b>	55x80	60x80	60x100	60x110	70x90	70x100	70x110
Door dimensions [cm]	<b>WxL</b>	53.4x78.4	58.4x78.4	58.4x98.4	58.4x108.4	68.4x88.4	68.4x98.4	68.4x108.4
Frame internal dimensions [cm]	<b>MxN</b>	48x73	53x73	53x93	53x103	63x83	63x93	63x103
Frame width [cm]	<b>S</b>	9						
Frame thickness [cm]	<b>Z</b>	2.7						

## L-SHAPED DOORS

Commercial sizes [cm]	55x80	60x80	60x100	60x110	70x90	70x100	70x110
Code	<b>869600</b>	<b>869622</b>	<b>869624</b>	<b>869625</b>	<b>869633</b>	<b>869634</b>	<b>869635</b>

DWT doors are available only in sizes shown above.



WOODEN  
DOORS



# L-SHAPED COMBINATION DOORS

**DWF** L-shaped combination fire-resistant doors have a 45-minute fire rating – EN 13501-2) to protect against the spread of flame while providing access to unused space behind a wall. The white 6.6cm thick sash has thermo insulation to provide an excellent barrier against heat loss ( $U=0.64W/m^2K^*$ ). The door can be installed in the right or left side. They are as standard equipped with wooden architrave lining in natural colour.

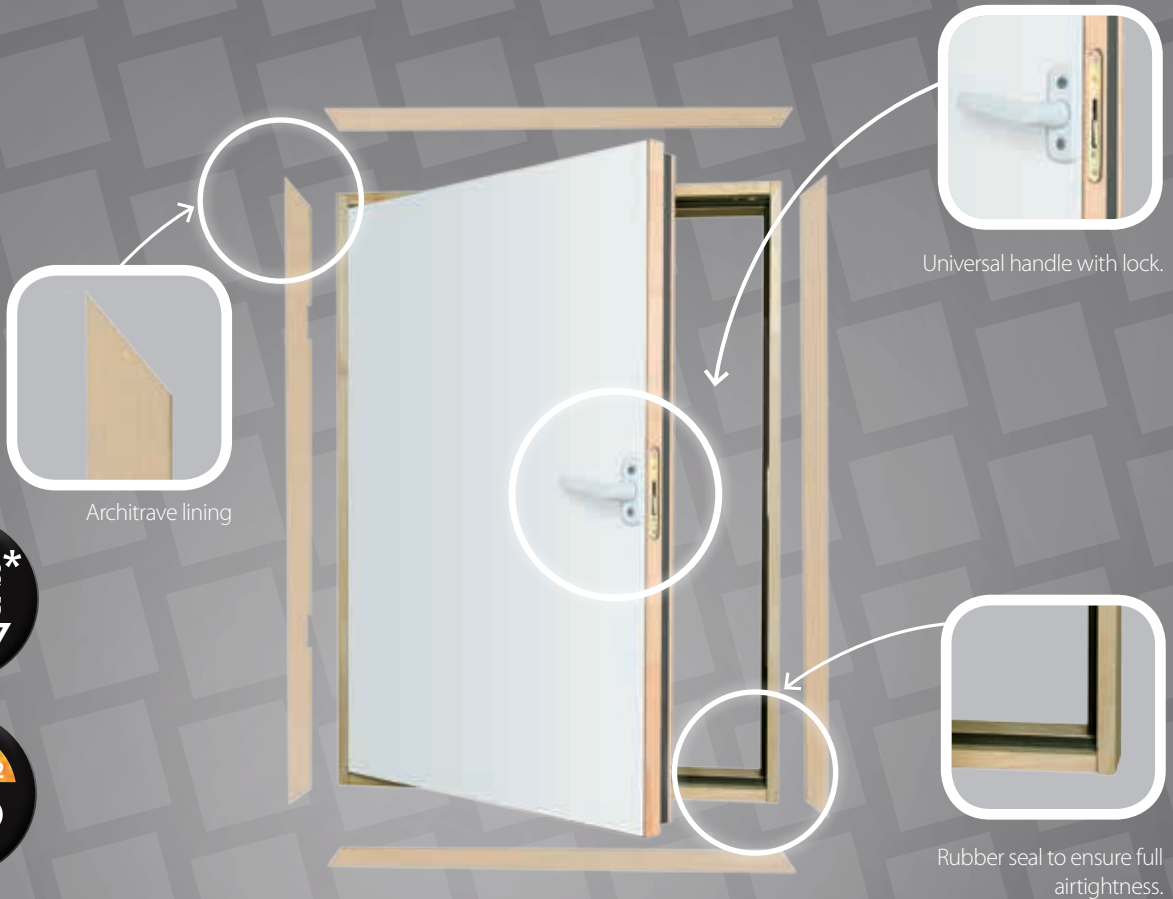

**4** CLASS\*  
EN12207

EN 13501.2  
EI, **45**

**U=0.64**\*  
W/m<sup>2</sup>K

\*manufacturer's own data



architrave lining



Technical specification:  
**fire-resistance EI<sub>1</sub>/EI<sub>2</sub>=45 minutes**  
**heat transmission coefficient U = 0.64 W/m<sup>2</sup>K**  
**insulation thickness 6 cm**

fully assembled,  
and ready for quick installation in the ceiling



**3** years  
WARRANTY

# DWF DOOR DIAGRAM

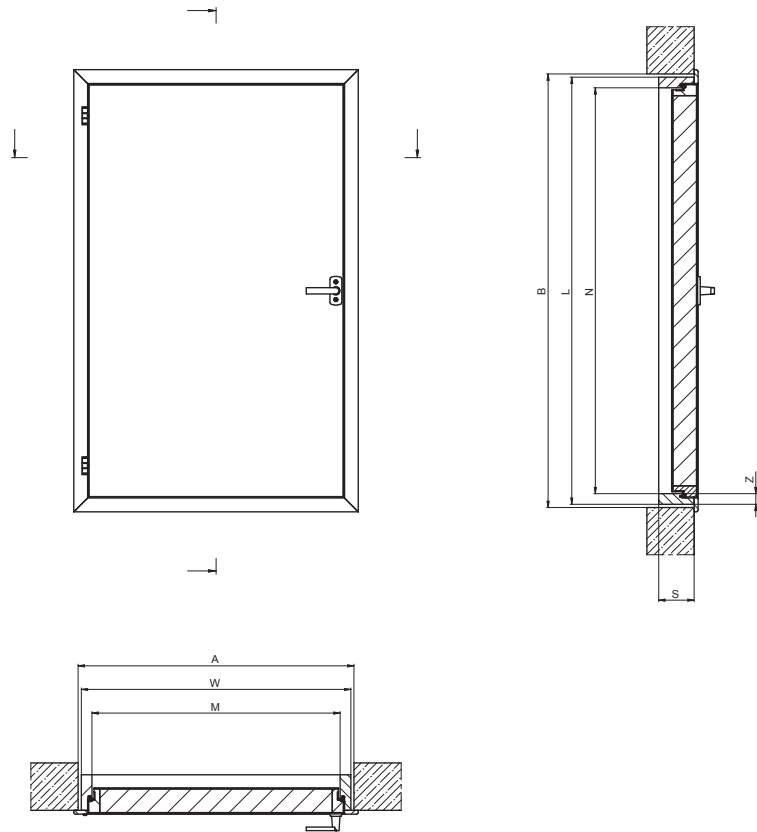

## DWF L-SHAPED DOORS DIMENSIONS

Opening dimensions [cm]	AxB	55x80	60x80	60x100	60x110	70x90	70x100	70x110
Door dimensions [cm]	WxL	53.4x78.4	58.4x78.4	58.4x98.4	58.4x108.4	68.4x88.4	68.4x98.4	68.4x108.4
Frame internal dimensions [cm]	MxN	48x73	53x73	53x93	53x103	63x83	63x93	63x103
Frame width [cm]	S	9						
Frame thickness [cm]	Z	2.7						

## L-SHAPED DOORS

Commercial sizes [cm]	55x80	60x80	60x100	60x110	70x90	70x100	70x110
Code	869800	869822	869824	869825	869833	869834	869835

DWF doors are available only in sizes shown above.

## BALUSTRADE LXB-U

The loft balustrade is made of pine wood, protects the ceiling opening in the attic and makes it easier and safer to descend the ladder. The LXB-U is installed directly to the loft floor and is strengthened with flat-bars. The LXB-U balustrade is suitable for the biggest loft ladder size 86x140 cm, so it can be applied to all types of loft ladder without cutting its horizontal bars.



LXB-U Balustrade	Available for loft ladders
	all FAKRO loft ladders
Standard dimensions [cm]	86 x 140
Non-standard dimensions [cm]	for loft ladder sizes smaller than 86x140 cm, the standard size balustrade is applied
Balustrade height [cm]	110

<b>Code</b>	<b>80AZ04</b>
-------------	---------------

## INSTALLATION BRACKETS LXK

Installation brackets facilitate loft ladder installation in the ceiling. Installed in the corners of the box, they add to its overall rigidity ensuring equal lengths of diagonals. Bolts are screwed into brackets guaranteeing quick and accurate levelling of the loft ladder in the ceiling.



Installation brackets	Available for loft ladders							
	LWK Komfort	LWL	LTK Energy	LWT	LWF 45	LDK	LMS	LMK
Installation to the ceiling max. thickness [cm]	35		39		43		35	

<b>Code</b>	<b>62085</b>
-------------	--------------

# ARCHITRAVE LININGS LXL

The architrave is designed to finish the installation of the loft ladder and to cover gaps in the ceiling which remain after the fitting process. The architrave elements are of solid pine wood (LXL-P) or in white (LXL-W) or PVC (LXL-PVC). This quick and simple fitting process ensures a fast, aesthetically pleasing finish of the installed Loft Ladder. In the case of PVC architrave, connection with the box does not require any nails. The LXL-PVC architrave is available in white\*.

Architrave linings LXL-P/-W	Available for loft ladders							
	LWK Komfort	LWL	LTK Energy	LWT	LWF-45	LDK	LMS	LMK
Standard dimensions [cm]	70 x 140							
Non-standard dimensions [cm]	1. For ladders in sizes smaller than 70x140 the standard size of architrave slats has to be cut. 2. For ladders in sizes bigger than 70x140 the non-standard architrave slats have to be ordered with the detailed box dimensions provided.							
Slats thickness after installation on box [cm]	1							
Slats width [cm]	3.5							
Max. width of the gaps, the architrave slats cover after installation on the box [cm]	2.5							



	LXL-P	LXL-W
		70x140
<b>Code</b>	<b>62087</b>	<b>62088</b>

Architrave linings LXL-PVC	Available for loft ladders							
	LWK Komfort	LWL	LTK Energy	LWT	LWF-45	LDK	LMS	LMK
Standard dimensions [cm]	60/70 x 120 or 86 x 140							
Non-standard dimensions [cm]	For ladders in sizes smaller than 86x140cm, the standard size of the slats has to be cut							
Slats thickness after installation on box [cm]	1							
Slats width [cm]	3.3							
Max. width of the gaps, the architrave slats cover after installation on the box [cm]	2.4							



	LXL-PVC		
		60x120	70x120
<b>Code</b>	<b>62082</b>	<b>62083</b>	<b>62084</b>

\* the architrave lining colour may slightly differ from the colour of lining in angles and hatch



## BOX EXTENSION LXN

Made of pine, the box extension matches perfectly with the box of the installed ladder and enhances the look of the ceiling opening. In addition, in case of ceiling thickness exceeding 31 cm, for 4-segment and scissors LST and LSZ loft ladders, the box extension serves as an extension element of a box height allowing for installation of the LXW upper hatch.



Box extension LXN	Available for loft ladders																
	LWK Komfort	LWZ Plus	LWL	LTK Energy	LWT	LWF 45	LDK	LMS	LMK	LML	LMF	LST	LSZ				
Height of the box extension frame [cm]	10																
Max. height of non-standard box extension [cm]	20						16	20									
LXN box extension commercial size [cm]	51x80	55x111	60x90	60x94	60x100	60x111	60x120	60x130	60x140	70x80	70x94	70x100	70x111	70x120	70x130	70x140	86x130
<b>Code</b>	<b>862300</b>	<b>862321</b>	<b>862322</b>	<b>862307</b>	<b>862306</b>	<b>862304</b>	<b>862301</b>	<b>862302</b>	<b>862303</b>	<b>862332</b>	<b>862317</b>	<b>862316</b>	<b>862314</b>	<b>862311</b>	<b>862312</b>	<b>862313</b>	<b>862396</b>

When ordering standard and non-standard box extensions, please specify the model and commercial size of loft ladders. The provided box extension size will be compatible with the loft ladder box.

## ADDITIONAL TREAD LXT

An additional tread makes climbing the ladder easier and increases comfort and safety when accessing the loft space. Made of wood, it is installed between the final tread and loft floor and is particularly recommended for use in situations where the upper hatch is installed on the ladder box or where ladders are installed in a thick ceiling.



Additional tread LXT	Available for loft ladders		
	LWL	LMS	LMK
External width of the ladders section [cm]	LXT300		
	38		
<b>Code</b>	<b>62059</b>		

# UPPER HATCH LXW

The LXW Upper Hatch prevents attic dust from accumulating on the hatch and steps of the closed ladder. It improves the overall insulating parameters and airtightness of the ladder on which it is installed. The upper hatch consists of a frame equipped with a peripheral gasket, 3.6cm thick hatch door, hardware, installation brackets, gas piston and rotational closing handle. In order to close the upper hatch from the loft side, it is possible to install an additional LXZ handle.

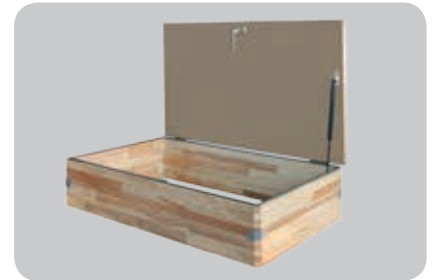

Upper hatch LXW	Available for loft ladders																
	LWK Komfort	LWZ Plus	LWL	LTK Energy	LWT	LWF 45	LMS	LMK	LML	LMF	LST	LSZ					
Max. thickness of the ceiling where the upper hatch can be installed [cm]	31 or after standard upper hatch installation 41. For 4 section ladders the use of the upper hatch is a must.	31 or after standard upper hatch installation 41.		35 or after standard upper hatch installation 45.	39 or after standard upper hatch installation 49.		31 or after standard upper hatch installation 41.		48 or after standard upper hatch installation 58.	33 or after standard upper hatch installation 43.		41, the upper hatch installation is a must					
Upper hatch box height [cm]	20																
Commercial sizes of LXW [cm]	51x80	55x111	60x90	60x94	60x100	60x111	60x120	60x130	60x140	70x80	70x94	70x100	70x111	70x120	70x130	70x140	86x130
<b>Code</b>	<b>862200</b>	<b>862221</b>	<b>862222</b>	<b>862207</b>	<b>862206</b>	<b>862204</b>	<b>862201</b>	<b>862202</b>	<b>862203</b>	<b>862232</b>	<b>862217</b>	<b>862216</b>	<b>862214</b>	<b>862211</b>	<b>862212</b>	<b>862213</b>	<b>862296</b>

When ordering standard and non-standard upper hatches, please specify the model and commercial size of loft ladders. The provided upper hatch size will be compatible with the loft ladder box.

# HANDLE LXZ

The LXZ handle enables the LXW upper hatch to be closed from the loft side e.g. during maintenance work in the loft or on the roof.

<b>Code</b>	<b>80AZ01</b>
-------------	---------------

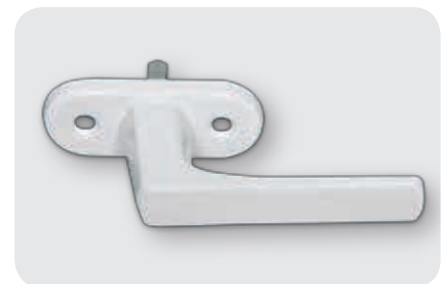

# STILE ENDS LXS

The **LXS Stile Ends** are finishing elements mounted on the base of the ladder, adding a smart touch to its appearance. They add to the ladder's stability and are made from specially selected material to protect the floor from being scratched. They are available for all segment of loft ladders with wooden ladder sections (besides 4-section and LDK loft ladder).

Code	62027
------	-------



# HANDRAIL LXH

The **LXH Metal Handrail** makes climbing the ladder easier and increases user's safety and comfort. It is mounted onto upper ladder section.



Handrail LXH	Available for loft ladders		
	LWK Komfort, LWZ Plus, LTK Energy, LWT, LWF45, LMS, LMK		LDK
Handrail is installed to the upper ladder section	LXH *50/13	LXH *75/13	LXH 75/16
<b>Code</b>	<b>80AZ24</b>	<b>80AZ18</b>	<b>62065</b>

\* Handrails LXH 50/13 are installed to ladder with boxes up to 100cm in length; handrails LXH 75/13 to ladders with boxes over 100cm in length

# INSULATION KIT LXD

The **LXD Insulation Kit** provides the standard of tight insulation between the ladder box and ceiling opening needed in energy-efficient construction. It includes: airtight collar, insulation material (sheep wool blocks) and an air permeable collar.



Insulation kit LXD	Available for loft ladders						
	LWK Komfort	LWL	LTK Energy	LWT	LDK	LMS	LMK
Standard dimensions [cm]	60/70x120 oraz 86 x 140						
Non-standard dimensions [cm]	For ladders smaller than 86x140cm, the standard size of the kit has to be adapted						
Commercial sizes LXD [cm]	60x120	70x120	86x140				
<b>Code</b>	<b>80AZ13</b>	<b>80AZ14</b>	<b>80AZ15</b>				

## AVAILABLE ADDITIONAL ACCESSORIES

	LWK Komfort	LWZ Plus	LWL	LTK Energy	LWT	LWF 45	LDK	LMS	LMK	LML	LMF	LST	LSZ	LSF
<b>LXB-U</b> balustrade	✓	✓	✓	✓	✓	✓	✓	✓	✓	✓	✓	✓	✓	✓
<b>LXH</b> handrail	✓	✓	—	✓	✓	✓	✓	✓	✓	—	—	—	—	—
<b>LXK</b> installation brackets	✓	—	✓	✓	✓	✓	✓	✓	✓	—	—	—	—	—
<b>LXL</b> architrave lining (wooden)	✓	—	✓	✓	✓	✓	✓	✓	✓	—	—	—	—	—
<b>LXL-PVC</b> architrave lining (plastic)	✓	—	✓	✓	✓	✓	✓	✓	✓	—	—	—	—	—
<b>LXS</b> stile ends (only for 3 sections ladders)	✓	✓	✓	✓	✓	✓	—	—	—	—	—	—	—	—
<b>LXN</b> box extension	✓	✓	✓	✓	✓	✓	✓	✓	✓	✓	✓	✓	✓	—
<b>LXW</b> upper hatch	✓*	✓	✓	✓*	✓	✓	—	✓	✓	✓	✓	✓*	✓*	—
<b>LXT</b> additional tread	—	—	✓	—	—	—	—	✓	✓	—	—	—	—	—
<b>LXD</b> insulation kit	✓	—	✓	✓	✓	—	✓	✓	✓	—	—	—	—	—

\* for 4 section loft ladders and scissors the LXN upper hatch is mounted prior to the upper hatch LXW installation







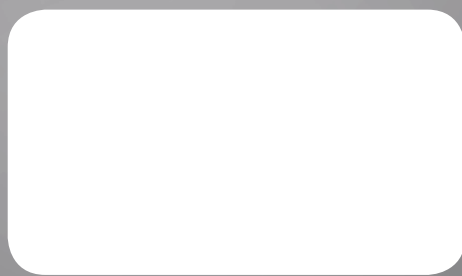

**FAKRO®**

Fakro GB Ltd  
Fakro House  
Astron Business Park  
Hearthcote Road  
Swadlincote DE11 9DW  
telephone : 01283 554755 fax : 01283 224545  
www.fakro.co.uk e-mail: sales@fakrogb.com

FAKRO reserves the right to change specifications and technical parameters of products without prior notice.