

Pozi ie	Cant.	Descriere
	1	<p>MAGNA1 25-120</p>  <p style="text-align: center;">Not ! Poza de produs poate diferi de produsul actual</p> <p>Nr. Produs: 97924146</p> <p>MAGNA1 circulator pump with easy selection of pump setting The pump is of the canned-rotor type, i.e. pump and motor form an integral unit without shaft seal and with only two gaskets for sealing. The bearings are lubricated by the pumped liquid. In order to avoid problems in connection with disposal, great importance has been attached to using as few different materials as possible. A pump with no maintenance requirements and extremely low life cycle cost.</p> <p>Heating systems</p> <ul style="list-style-type: none"> • Main pump • mixing loops • heating surfaces • air-conditioning surfaces. <p>The MAGNA1 circulator pumps are designed for circulating liquids in heating systems with variable flows where it is desirable to optimise the setting of the pump duty point, thus reducing energy costs. The pumps are also suitable for domestic hot-water systems.</p> <p>To ensure correct operation, it is important that the sizing range of the system falls within the duty range of the pump.</p> <p>Benefits</p> <ul style="list-style-type: none"> • Safe selection. • Simple installation. • Low energy consumption. All MAGNA1 pumps comply with the EuP requirements. • Nine light fields for indication of pump setting. Three proportional-pressure curves, three constant-pressure curves and three fixed-speed curves are available. • Low noise level. • No maintenance and long life. <p>Liquid:</p> <p>Lichide pompate: Ap Gama temperaturii lichidului: -10 .. 110 °C Temp. lichid: 60 °C Densitate: 983.2 kg/m³</p> <p>Technical:</p> <p>Clasa TF: 110 Aprob ri pe etichet : CE,VDE,EAC</p> <p>Materials:</p> <p>Corpul pompei (stator): Font EN-GJL-200</p>

Pozitie	Cant.	Descriere
		<p>ASTM A48-200B Rotor: PES 30%GF</p> <p>Instalatie: Gama temperaturii ambientale: 0 .. 40 °C Presiune de funcționare maxim : 10 bar Racordarea pompei la instalatie: G 1 1/2" Presiune maxim de funcționare: PN10 Distanța dintre porturi: 180 mm</p> <p>Electrical data: Power input - P1: 8 .. 188 W Curent consumat maxim: 0.08 .. 1.51 A Frecvența rețelei electrice: 50 Hz Tensiune nominal : 1 x 230 V Grad de protecție (IEC 34-5): X4D Clasă de izolare (IEC 85): F</p> <p>Others: Label: Grundfos Blueflux Energy (EEI): 0.21 Greutate net : 4.38 kg Greutate brut : 4.78 kg Volum de transport: 0.012 m³</p>

97924146 MAGNA1 25-120 50 Hz

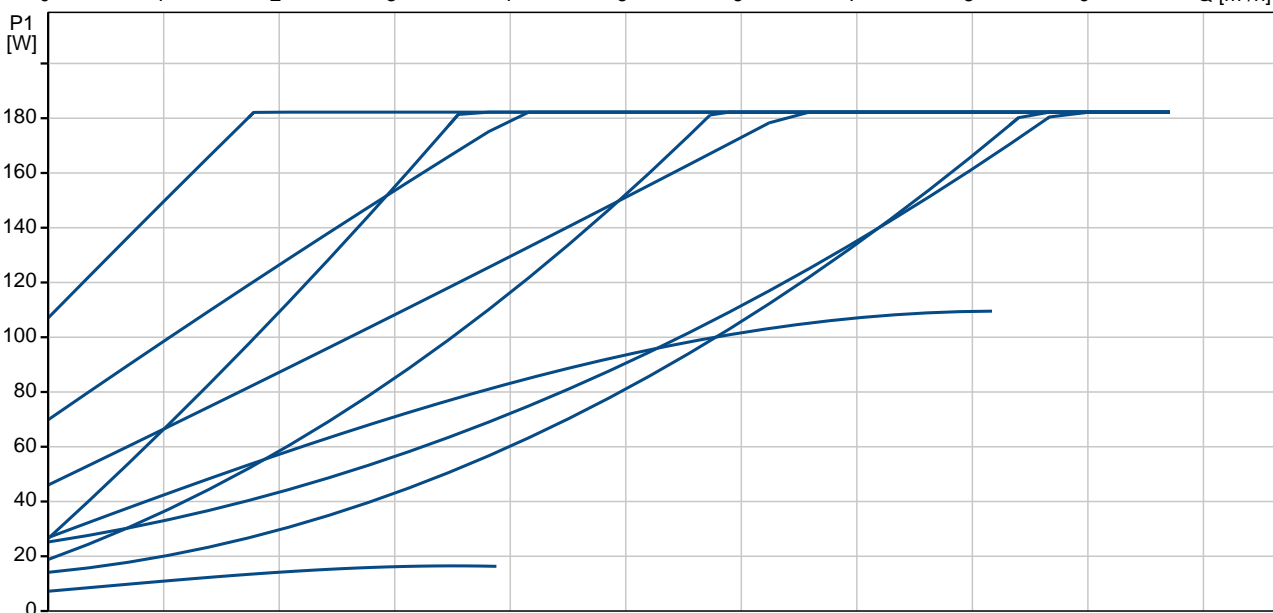
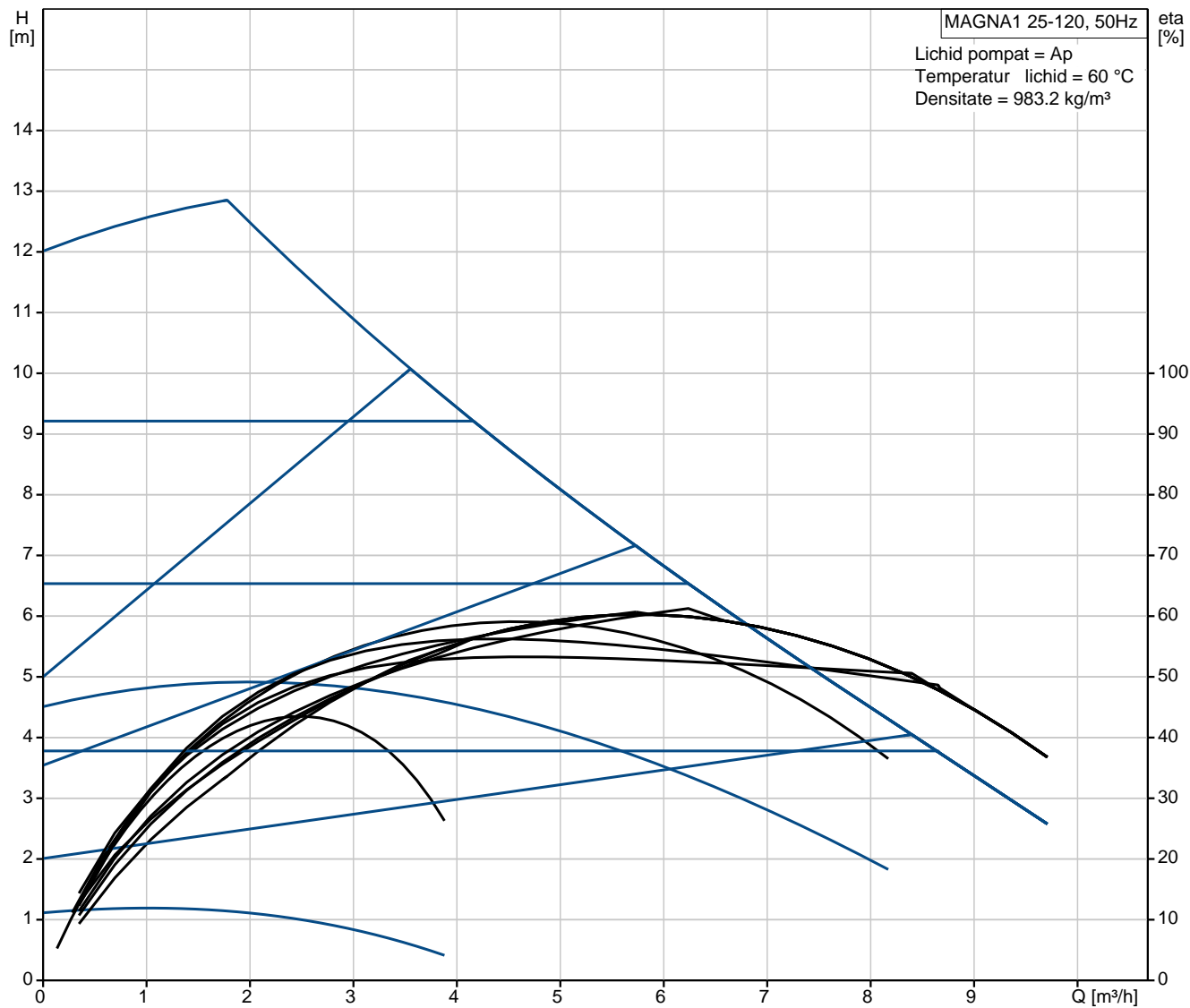

Descriere	Valori i tipuri
-----------	-----------------

Informa ii generale:

Nume produs::	MAGNA1 25-120
Nr. produs::	97924146
Numărul EAN::	5710626492206
Pre :	La cerere

Technical:

În l ime de pompare max.:	120 dm
Clasa TF:	110
Aprob ri pe etichet :	CE,VDE,EAC
Model:	A

Materials:

Corpul pompei (stator):	Font EN-GJL-200
Rotor:	ASTM A48-200B PES 30%GF

Instala ie:

Gama temperaturii ambientale:	0 .. 40 °C
Presiune de func ionare maxim :	10 bar
Racordarea pompei la instala ie:	G 1 1/2"
Presiune maxim de func ionare:	PN10
Distan a dintre porturi:	180 mm

Liquid:

Lichide pompate:	Ap
Gama temperaturii lichidului:	-10 .. 110 °C
Temp. lichid:	60 °C
Densitate:	983.2 kg/m ³

Electrical data:

Power input - P1:	8 .. 188 W
Curent consumat maxim:	0.08 .. 1.51 A
Frecven a re elei electrice:	50 Hz
Tensiune nominal :	1 x 230 V
Grad de protec ie (IEC 34-5):	X4D
Clas de izolare (IEC 85):	F

Others:

Label:	Grundfos Blueflux
Energy (EEI):	0.21
Greutate net :	4.38 kg
Greutate brut :	4.78 kg
Volum de transport:	0.012 m ³

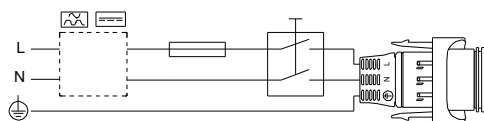
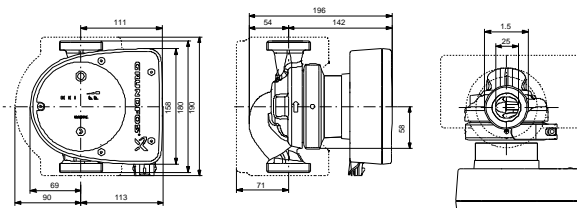
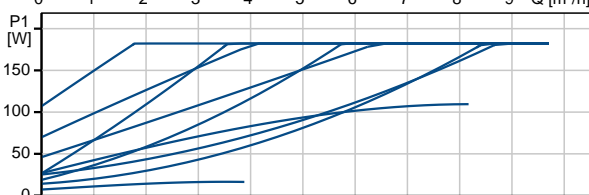
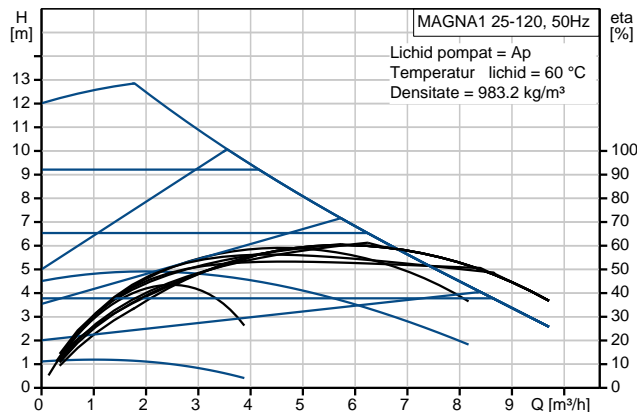

97924146 MAGNA1 25-120 50 Hz

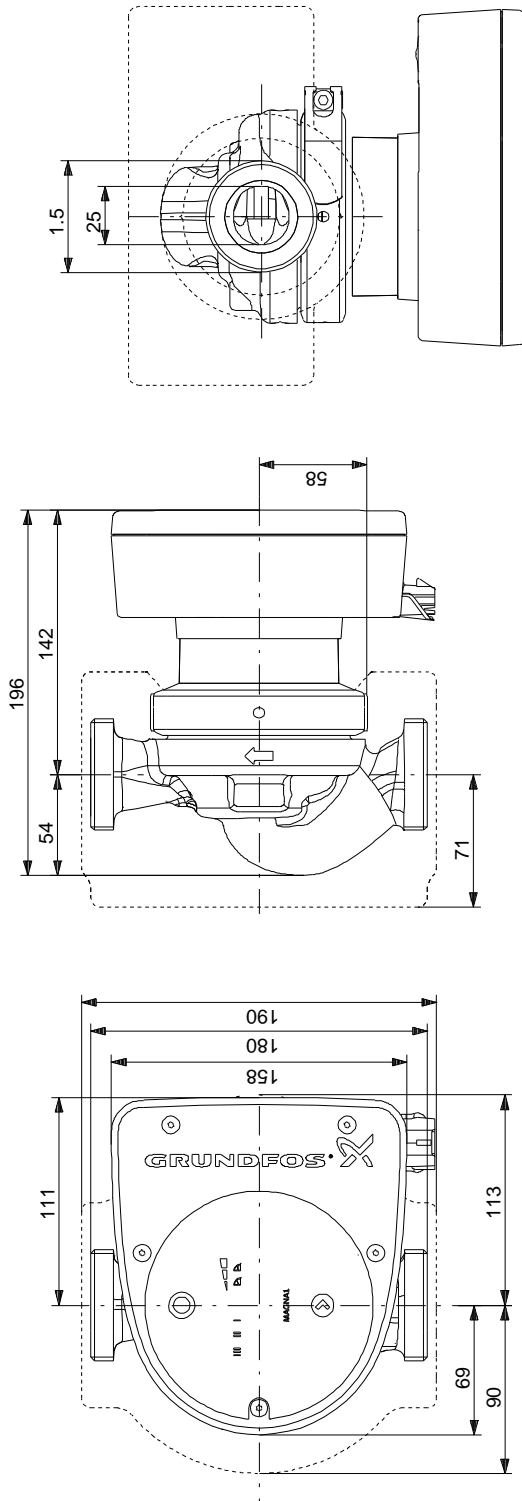

Note! All units are in [mm] unless others are stated.
Disclaimer: This simplified dimensional drawing does not show all details.

97924146 MAGNA1 25-120 50 Hz

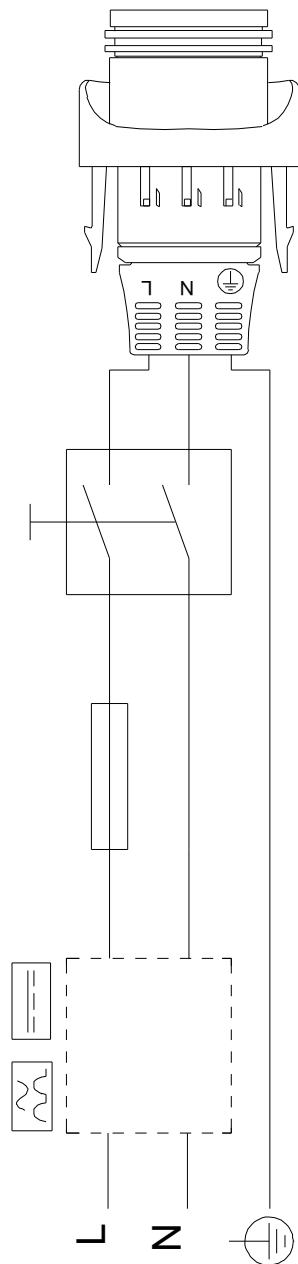

Not ! Toate unit ile sunt în [mm] dac nu altele sunt condi iile.