

Pozi ie	Cant.	Descriere
	1	<p data-bbox="352 163 571 197">MAGNA3 50-100 F</p>  <p data-bbox="746 595 1230 618" style="text-align: center;">Not ! Poza de produs poate diferi de produsul actual</p> <p data-bbox="352 629 608 651">Nr. Produs: 97924283</p> <p data-bbox="352 685 1422 790"> MAGNA3 – More than a pump With its unrivalled efficiency, all-encompassing range and built-in communication capabilities plus functionalities replacing system components, the MAGNA3 is ideal for engineers and specifiers looking to create high-performance systems for buildings. </p> <p data-bbox="352 801 1390 853"> This pump in the Grundfos Master Class will fit both heating and cooling applications perfectly, making it the obvious choice for almost any building project – old or new. </p> <p data-bbox="352 887 1449 1003"> The MAGNA3 is of the canned-rotor type, i.e. pump and motor form an integral unit without shaft seal and with only two gaskets for sealing. The bearings are lubricated by the pumped liquid. The innovative clamp with only one screw enables easy repositioning of the pump head. The MAGNA3 is a pump with no maintenance requirements and with extremely low Life Cycle Cost. </p> <p data-bbox="352 1066 831 1088">The pump is characterised by the following:</p> <ul data-bbox="352 1093 943 1361" style="list-style-type: none"> • controller integrated in the control box • control panel with TFT display on the control box • control box prepared for optional CIM modules • built-in differential-pressure and temperature sensor • cast-iron pump housing (depending on model) • carbon-fibre-reinforced composite rotor can • stainless-steel bearing plate and rotor cladding • aluminium alloy stator housing • air-cooled power electronics <p data-bbox="352 1364 778 1386">The MAGNA3 is a single-phase pump.</p> <p data-bbox="352 1420 603 1442">Characteristic features</p> <ul data-bbox="352 1447 1382 1827" style="list-style-type: none"> • AUTOADAPT. • FLOWADAPT and FLOWLIMIT (more than a pump function as it reduces the need for pump throttling valves). • Proportional-pressure control. • Constant-pressure control. • Constant-temperature control. • Constant-curve duty. • Max. or min. curve duty. • Automatic Night Setback. • No external motor protection required. • Insulating shells supplied with single-head pumps for heating systems. • Large temperature range where the liquid temperature and the ambient temperature are independent of each other. <p data-bbox="352 1861 528 1883">Communication</p> <p data-bbox="352 1888 967 1910">The MAGNA3 enables communication via the following:</p> <ul data-bbox="352 1915 823 2033" style="list-style-type: none"> • wireless Grundfos GO Remote • fieldbus communication via CIM modules • digital inputs • relay outputs

Pozi ie	Cant.	Descriere
		<ul style="list-style-type: none"> • analog input (more than a pump function as heat energy meter) <p>Motor and electronic controller The MAGNA3 incorporates a 4-pole synchronous, permanent-magnet motor (PM motor). This motor type is characterised by higher efficiency than a conventional asynchronous squirrel-cage motor.</p> <p>The pump speed is controlled by an integrated frequency converter. A differential-pressure and temperature sensor is incorporated in the pump.</p> <p>Liquid: Lichide pompate: Ap Gama temperaturii lichidului: -10 .. 110 °C Temp. lichid: 20 °C Densitate: 998.2 kg/m³</p> <p>Technical: Clasa TF: 110 Aprob ri pe etichet : CE,VDE,PCT</p> <p>Materials: Corpul pompei (stator): Font EN-GJL-250 ASTM A48-250B Rotor: PES 30%GF</p> <p>Instala ie: Gama temperaturii ambientale: 0 .. 40 °C Presiune de func ionare maxim : 10 bar Tip flan : DIN Racordarea pompei la instala ie: DN 50 Presiune maxim de func ionare: PN6/10 Distan a dintre porturi: 280 mm</p> <p>Electrical data: Power input - P1: 21 .. 429 W Curent consumat maxim: 0.22 .. 1.91 A Frecven a re elei electrice: 50 Hz Tensiune nominal : 1 x 230 V Grad de protec ie (IEC 34-5): X4D Clas de izolare (IEC 85): F</p> <p>Others: Label: Grundfos Blueflux Energy (EEI): 0.18 Greutate net : 18.2 kg Greutate brut : 20.3 kg Volum de transport: 0.046 m³</p>

97924283 MAGNA3 50-100 F 50 Hz

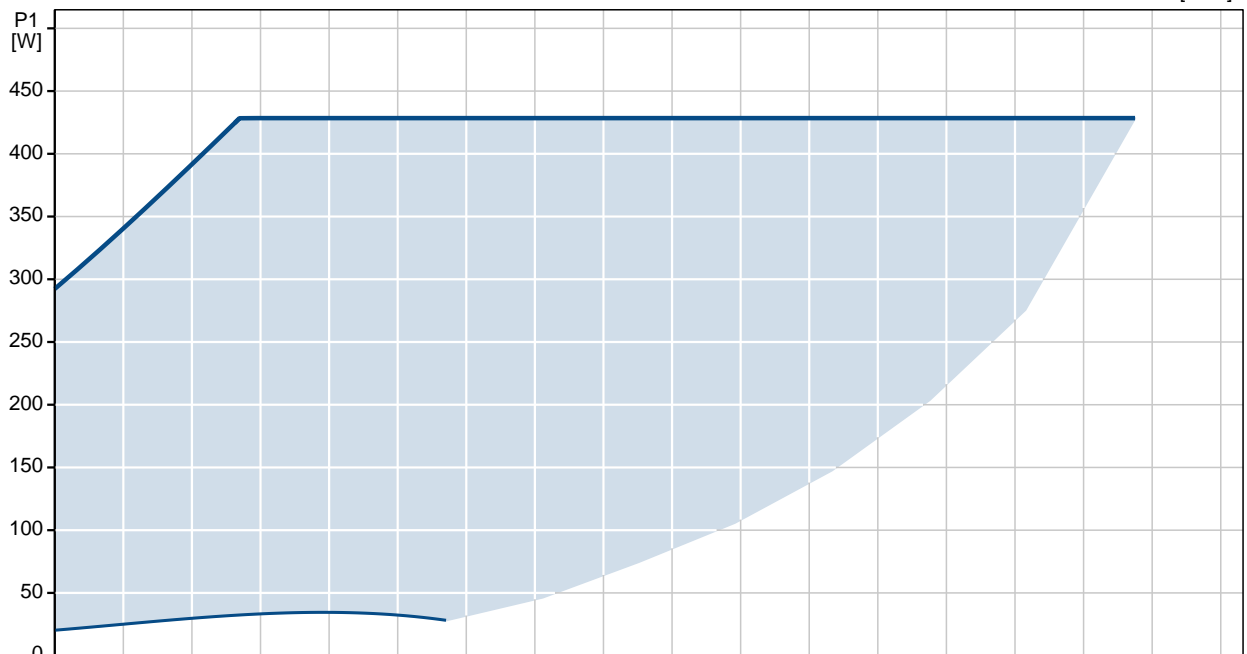
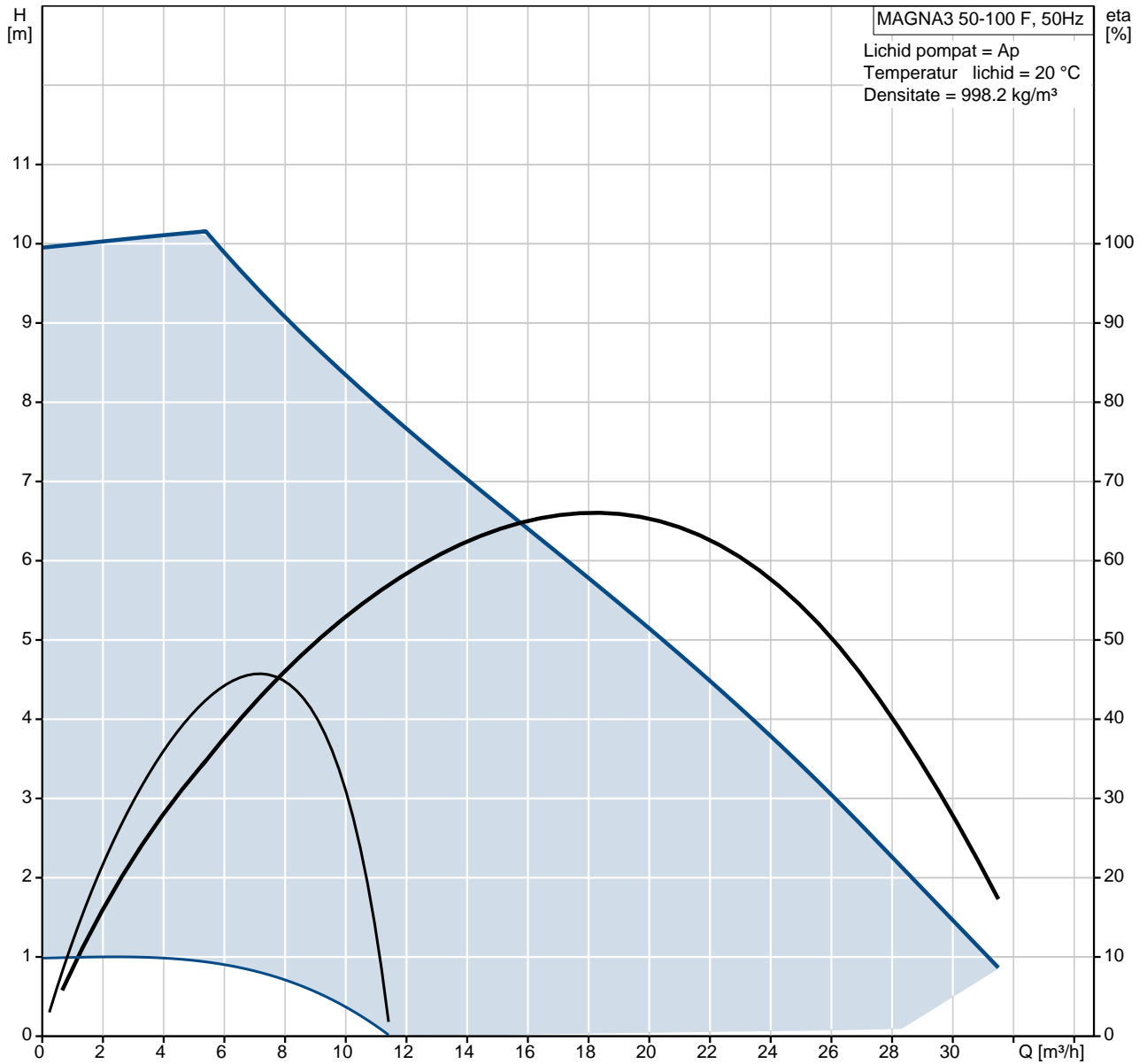

Descriere	Valori i tipuri
Nume produs:	MAGNA3 50-100 F
Nr. produs:	97924283
Num rul EAN:	5710626493586
Technical:	
În l ime de pompare max.:	100 dm
Clasa TF:	110
Aprob ri pe etichet :	CE,VDE,PCT
Model:	A
Materials:	
Corpul pompei (stator):	Font EN-GJL-250 ASTM A48-250B
Rotor:	PES 30%GF
Instala ie:	
Gama temperaturii ambientale:	0 .. 40 °C
Presiune de func ionare maxim :	10 bar
Tip flan :	DIN
Racordarea pompei la instala ie:	DN 50
Presiune maxim de func ionare:	PN6/10
Distan a dintre porturi:	280 mm
Liquid:	
Lichide pompate:	Ap
Gama temperaturii lichidului:	-10 .. 110 °C
Temp. lichid:	20 °C
Densitate:	998.2 kg/m ³
Electrical data:	
Power input - P1:	21 .. 429 W
Current consumat maxim:	0.22 .. 1.91 A
Frecven a re elei electrice:	50 Hz
Tensiune nominal :	1 x 230 V
Grad de protec ie (IEC 34-5):	X4D
Clas de izolare (IEC 85):	F
Others:	
Label:	Grundfos Blueflux
Energy (EEI):	0.18
Greutate net :	18.2 kg
Greutate brut :	20.3 kg
Volum de transport:	0.046 m ³

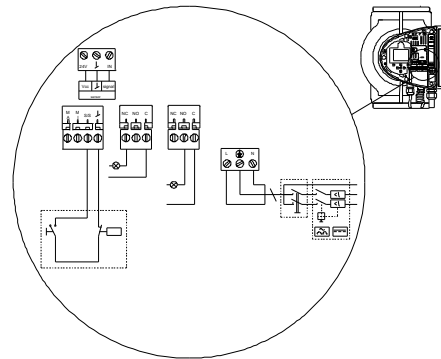
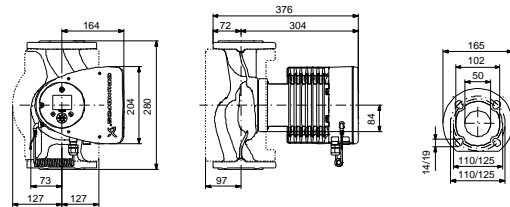
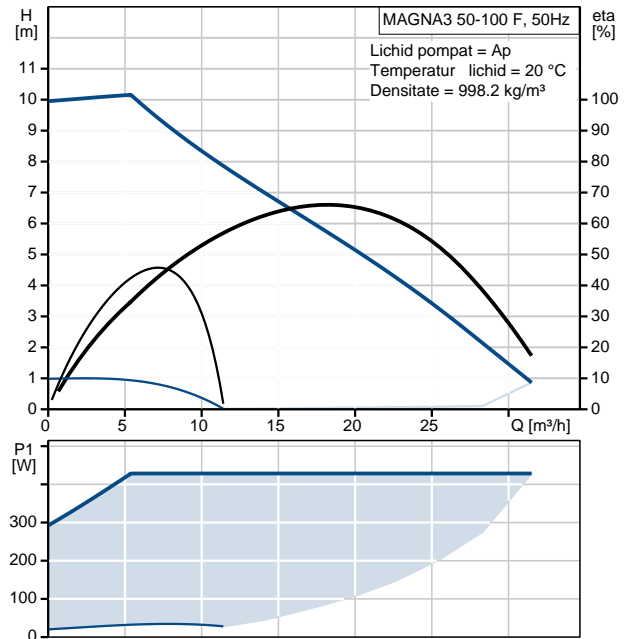

97924283 MAGNA3 50-100 F 50 Hz

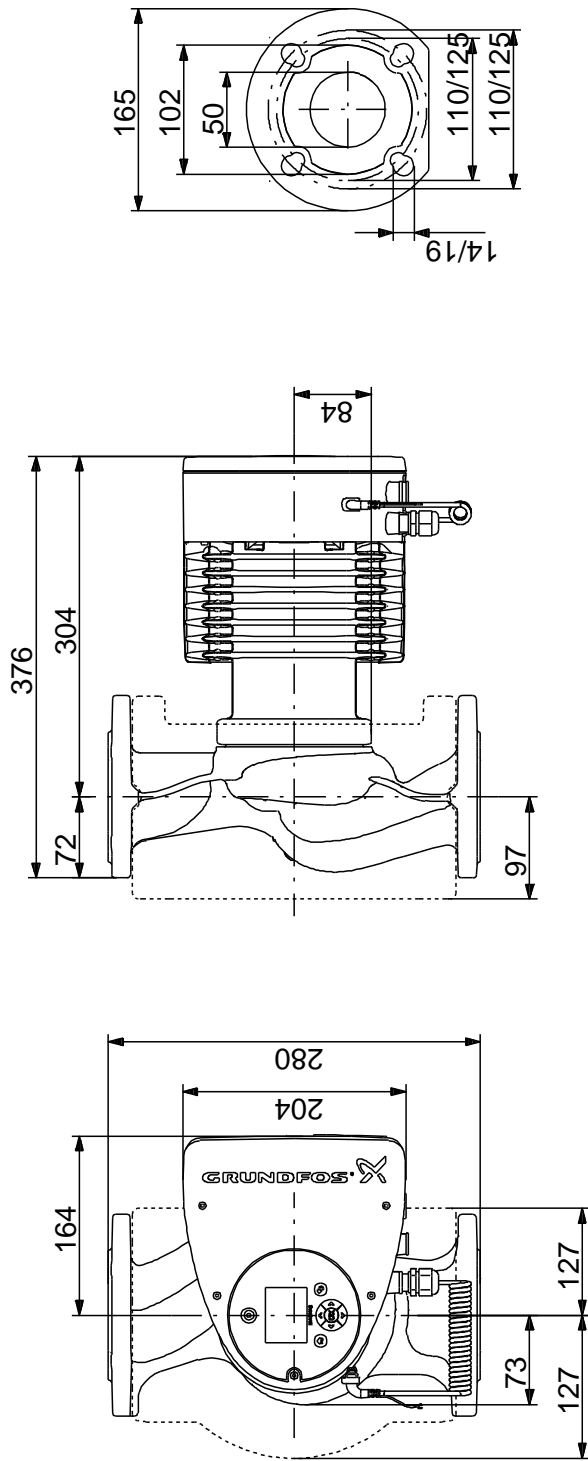

Note! All units are in [mm] unless others are stated.
Disclaimer: This simplified dimensional drawing does not show all details.

97924283 MAGNA3 50-100 F 50 Hz

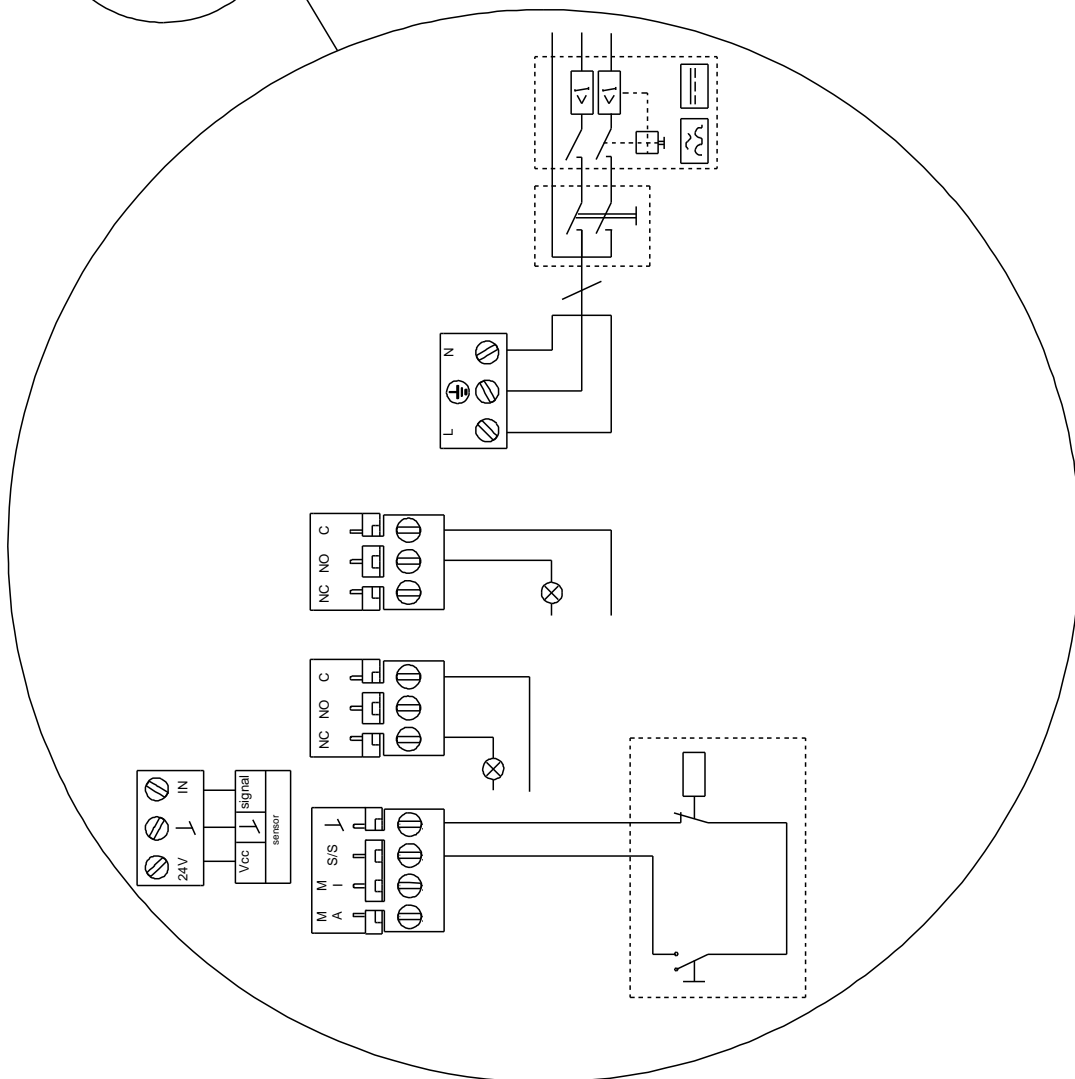
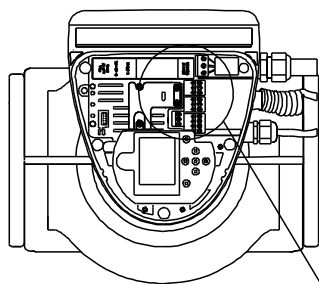

Not ! Toate unit ile sunt în [mm] dac nu altele sunt condi iile.