

Pozi ie	Cant.	Descriere
	1	<p>MAGNA3 25-40</p>  <p style="text-align: center;">Not ! Poza de produs poate diferi de produsul actual</p> <p>Nr. Produs: 97924244</p> <p>MAGNA3 – More than a pump With its unrivalled efficiency, all-encompassing range and built-in communication capabilities plus functionalities replacing system components, the MAGNA3 is ideal for engineers and specifiers looking to create high-performance systems for buildings.</p> <p>This pump in the Grundfos Master Class will fit both heating and cooling applications perfectly, making it the obvious choice for almost any building project – old or new.</p> <p>The MAGNA3 is of the canned-rotor type, i.e. pump and motor form an integral unit without shaft seal and with only two gaskets for sealing. The bearings are lubricated by the pumped liquid. The innovative clamp with only one screw enables easy repositioning of the pump head. The MAGNA3 is a pump with no maintenance requirements and with extremely low Life Cycle Cost.</p> <p>The pump is characterised by the following:</p> <ul style="list-style-type: none"> • controller integrated in the control box • control panel with TFT display on the control box • control box prepared for optional CIM modules • built-in differential-pressure and temperature sensor • cast-iron pump housing (depending on model) • carbon-fibre-reinforced composite rotor can • stainless-steel bearing plate and rotor cladding • aluminium alloy stator housing • air-cooled power electronics <p>The MAGNA3 is a single-phase pump.</p> <p>Characteristic features</p> <ul style="list-style-type: none"> • AUTOADAPT. • FLOWADAPT and FLOWLIMIT (more than a pump function as it reduces the need for pump throttling valves). • Proportional-pressure control. • Constant-pressure control. • Constant-temperature control. • Constant-curve duty. • Max. or min. curve duty. • Automatic Night Setback. • No external motor protection required. • Insulating shells supplied with single-head pumps for heating systems. • Large temperature range where the liquid temperature and the ambient temperature are independent of each other. <p>Communication The MAGNA3 enables communication via the following:</p> <ul style="list-style-type: none"> • wireless Grundfos GO Remote • fieldbus communication via CIM modules • digital inputs • relay outputs • analog input (more than a pump function as heat energy meter)

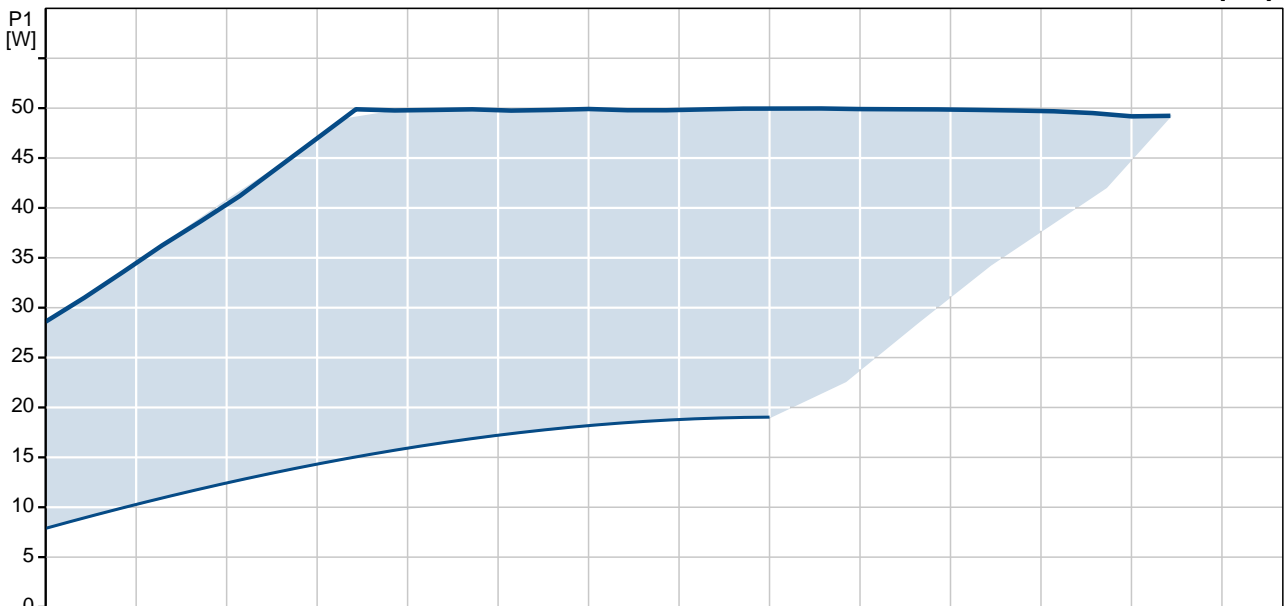

Pozi ie	Cant.	Descriere
		<p>Motor and electronic controller The MAGNA3 incorporates a 4-pole synchronous, permanent-magnet motor (PM motor). This motor type is characterised by higher efficiency than a conventional asynchronous squirrel-cage motor. The pump speed is controlled by an integrated frequency converter. A differential-pressure and temperature sensor is incorporated in the pump.</p> <p>Liquid: Lichide pompate: Ap Gama temperaturii lichidului: -10 .. 110 °C Temp. lichid: 60 °C Densitate: 983.2 kg/m³</p> <p>Technical: Clasa TF: 110 Aprob ri pe etichet : CE,VDE,EAC</p> <p>Materials: Corpul pompei (stator): Font EN-GJL-200 ASTM A48-200B Rotor: PES 30%GF</p> <p>Instala ie: Gama temperaturii ambientale: 0 .. 40 °C Presiune de func ionare maxim : 10 bar Racordarea pompei la instala ie: G 1 1/2" Presiune maxim de func ionare: PN10 Distan a dintre porturi: 180 mm</p> <p>Electrical data: Power input - P1: 9 .. 56 W Curent consumat maxim: 0.09 .. 0.46 A Frecven a re elei electrice: 50 Hz Tensiune nominal : 1 x 230 V Grad de protec ie (IEC 34-5): X4D Clas de izolare (IEC 85): F</p> <p>Others: Label: Grundfos Blueflux Energy (EEI): 0.19 Greutate net : 4.81 kg Greutate brut : 5.27 kg Volum de transport: 0.015 m³</p>

97924244 MAGNA3 25-40 50 Hz

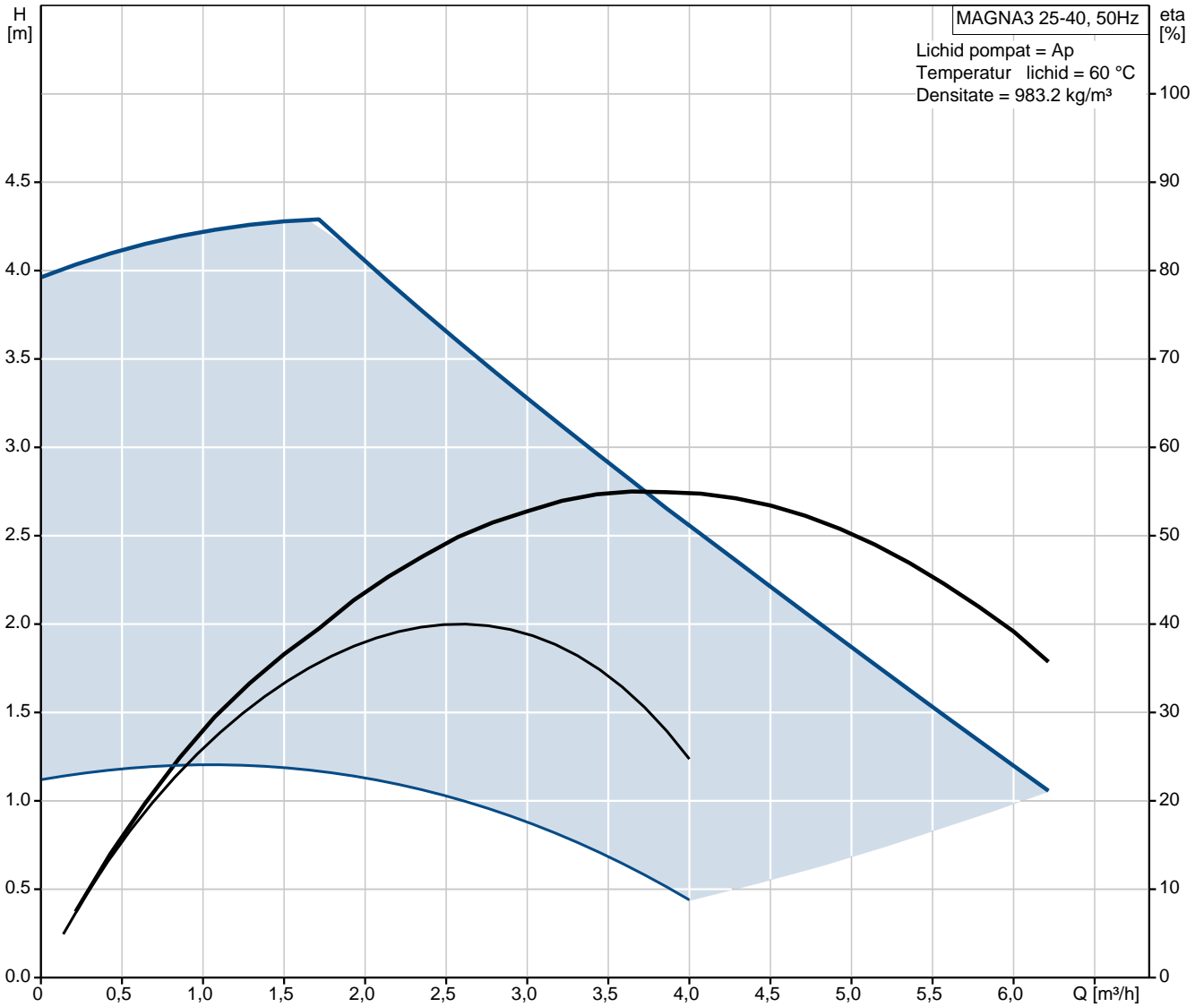

Nume companie:

Creat de:

Telefon:

Date:

12/15/2015

Descriere Valori i tipuri

Informa ii generale:

Nume produs::	MAGNA3 25-40
Nr. produs::	97924244
Numărul EAN::	5710626493197
Pre :	La cerere

Technical:

În l ime de pompare max.:	40 dm
Clasa TF:	110
Aprob ri pe etichet :	CE,VDE,EAC
Model:	B

Materials:

Corpul pompei (stator):	Font EN-GJL-200 ASTM A48-200B
Rotor:	PES 30%GF

Instala ie:

Gama temperaturii ambientale:	0 .. 40 °C
Presiune de func ionare maxim :	10 bar
Racordarea pompei la instala ie:	G 1 1/2"
Presiune maxim de func ionare:	PN10
Distan a dintre porturi:	180 mm

Liquid:

Lichide pompate:	Ap
Gama temperaturii lichidului:	-10 .. 110 °C
Temp. lichid:	60 °C
Densitate:	983.2 kg/m ³

Electrical data:

Power input - P1:	9 .. 56 W
Curent consumat maxim:	0.09 .. 0.46 A
Frecven a re elei electrice:	50 Hz
Tensiune nominal :	1 x 230 V
Grad de protec ie (IEC 34-5):	X4D
Clas de izolare (IEC 85):	F

Others:

Label:	Grundfos Blueflux
Energy (EEI):	0.19
Greutate net :	4.81 kg
Greutate brut :	5.27 kg
Volum de transport:	0.015 m ³

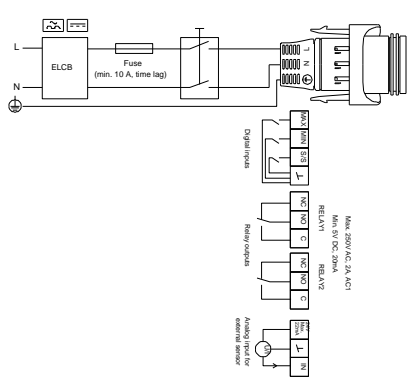
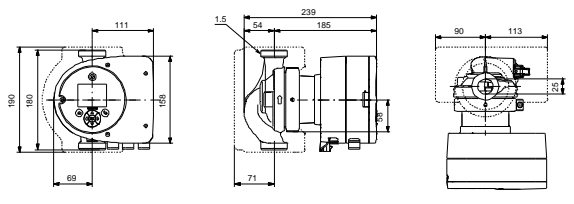
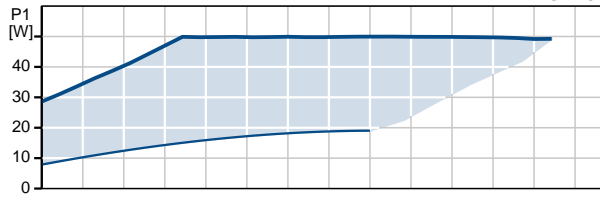
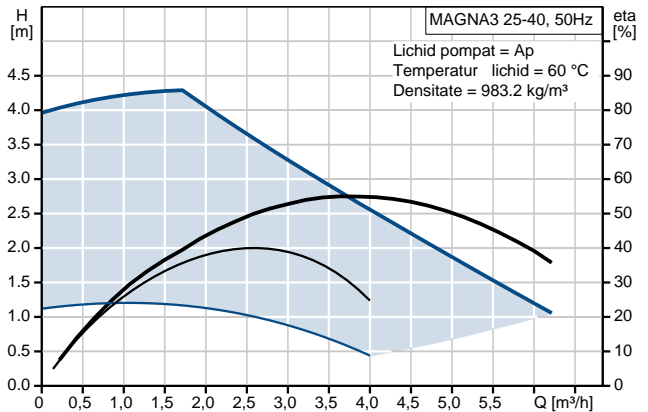

97924244 MAGNA3 25-40 50 Hz

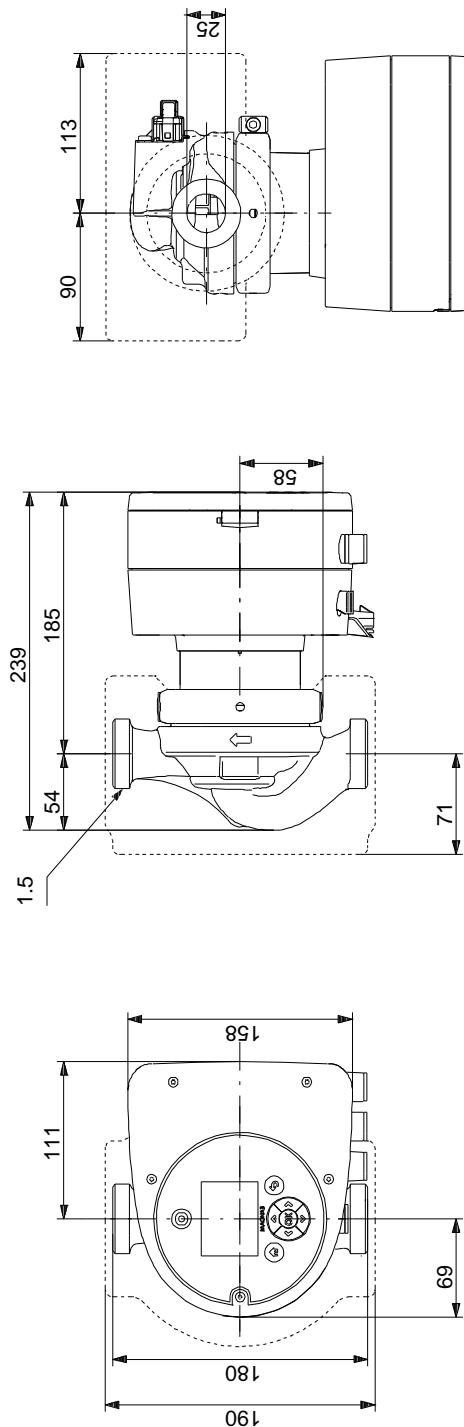

Note! All units are in [mm] unless others are stated.
Disclaimer: This simplified dimensional drawing does not show all details.

97924244 MAGNA3 25-40 50 Hz

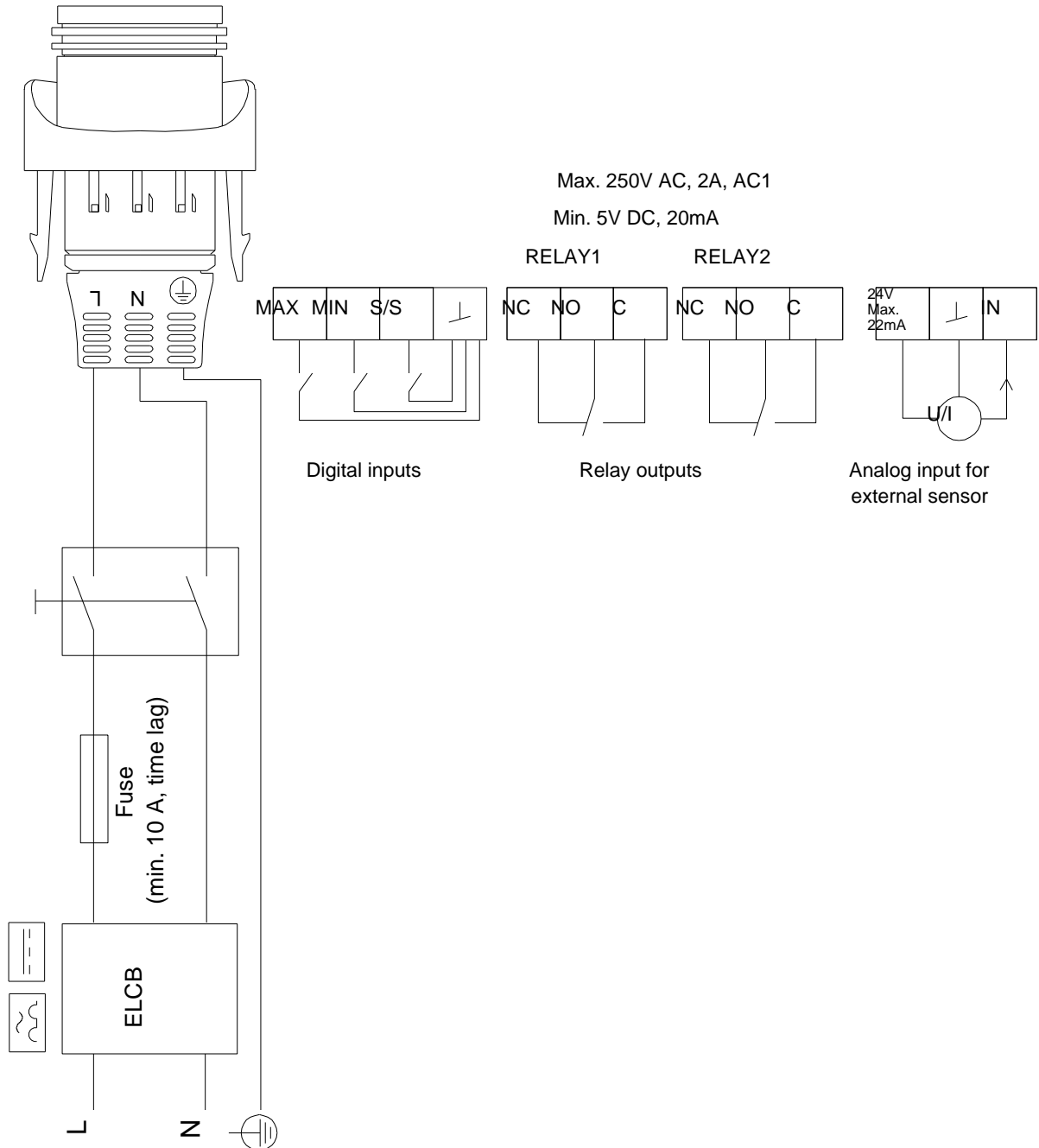

Not ! Toate unit ile sunt în [mm] dac nu altele sunt condi iile.