

Pozi ie	Cant.	Descriere																										
	1	<p>ALPHA2 25-60 180</p>  <p style="text-align: center;">Not ! Poza de produs poate diferi de produsul actual</p> <p>Nr. Produs: 97993201</p> <p>High-efficiency circulator pump with permanent-magnet motor (ECM technology) and integrated electronic performance adaptation due to continuously variable speed control for circulation of clean heating water according to VDI 2035.</p> <p>Features and benefits:</p> <ul style="list-style-type: none"> • No more experiments of settings. The AUTOADAPT function will automatically find the best setpoint. • No extra costs. • Insulating shells are supplied with pumps for heating systems. • Everything under control thanks to display showing actual power consumption in Watt or actual flow in m³/h. • High energy savings due to the best energy efficiency index (EEI) in the market. • For sensitive applications, stainless-steel pump housings are available. • Complies with the German regulation for energy saving in buildings and building systems - Energieeinsparverordnung – EnEV §14(3). • Automatic Night Setback that further reduces the energy consumption. • Simple selection among three constant-pressure curves, three proportional-pressure curves or three fixed speeds with only one button. • Easy electrical connection due to new ALPHA plug. • Higher application flexibility as the ALPHA2 is now suitable for cold-water systems. • No corrosion issues due to electro-coated pump housing. • Reduced installation costs as no external motor protection is required. <p>Liquid:</p> <table> <tr> <td>Lichide pompatate:</td> <td>Ap</td> </tr> <tr> <td>Gama temperaturii lichidului:</td> <td>0 .. 110 °C</td> </tr> <tr> <td>Temp. lichid:</td> <td>20 °C</td> </tr> <tr> <td>Densitate:</td> <td>998.2 kg/m³</td> </tr> </table> <p>Technical:</p> <table> <tr> <td>Clasa TF:</td> <td>110</td> </tr> <tr> <td>Aprob ri pe etichet :</td> <td>VDE,GS,CE</td> </tr> </table> <p>Materials:</p> <table> <tr> <td>Corpul pompei (stator):</td> <td>Font EN-GJL-150 ASTM A48-150B</td> </tr> <tr> <td>Rotor:</td> <td>PES 30%GF</td> </tr> </table> <p>Instala ie:</p> <table> <tr> <td>Gama temperaturii ambientale:</td> <td>0 .. 40 °C</td> </tr> <tr> <td>Presiune de func ionare maxim :</td> <td>10 bar</td> </tr> <tr> <td>Racordarea pompei la instala ie:</td> <td>G 1 1/2</td> </tr> <tr> <td>Presiune maxim de func ionare:</td> <td>PN 10</td> </tr> <tr> <td>Distan a dintre porturi:</td> <td>180 mm</td> </tr> </table>	Lichide pompatate:	Ap	Gama temperaturii lichidului:	0 .. 110 °C	Temp. lichid:	20 °C	Densitate:	998.2 kg/m ³	Clasa TF:	110	Aprob ri pe etichet :	VDE,GS,CE	Corpul pompei (stator):	Font EN-GJL-150 ASTM A48-150B	Rotor:	PES 30%GF	Gama temperaturii ambientale:	0 .. 40 °C	Presiune de func ionare maxim :	10 bar	Racordarea pompei la instala ie:	G 1 1/2	Presiune maxim de func ionare:	PN 10	Distan a dintre porturi:	180 mm
Lichide pompatate:	Ap																											
Gama temperaturii lichidului:	0 .. 110 °C																											
Temp. lichid:	20 °C																											
Densitate:	998.2 kg/m ³																											
Clasa TF:	110																											
Aprob ri pe etichet :	VDE,GS,CE																											
Corpul pompei (stator):	Font EN-GJL-150 ASTM A48-150B																											
Rotor:	PES 30%GF																											
Gama temperaturii ambientale:	0 .. 40 °C																											
Presiune de func ionare maxim :	10 bar																											
Racordarea pompei la instala ie:	G 1 1/2																											
Presiune maxim de func ionare:	PN 10																											
Distan a dintre porturi:	180 mm																											

Pozi ie	Cant.	Descriere
		<p>Electrical data:</p> <p>Power input - P1: 3 .. 34 W</p> <p>Curent consumat maxim: 0.04 .. 0.32 A</p> <p>Frecven a re elei electrice: 50 Hz</p> <p>Tensiune nominal : 1 x 230 V</p> <p>Grad de protec ie (IEC 34-5): X4D</p> <p>Clas de izolare (IEC 85): F</p> <p>Others:</p> <p>Energy (EEL): 0.17</p> <p>Greutate net : 2.01 kg</p> <p>Greutate brut : 2.13 kg</p> <p>Volum de transport: 0.004 m³</p>

97993201 ALPHA2 25-60 180 50 Hz

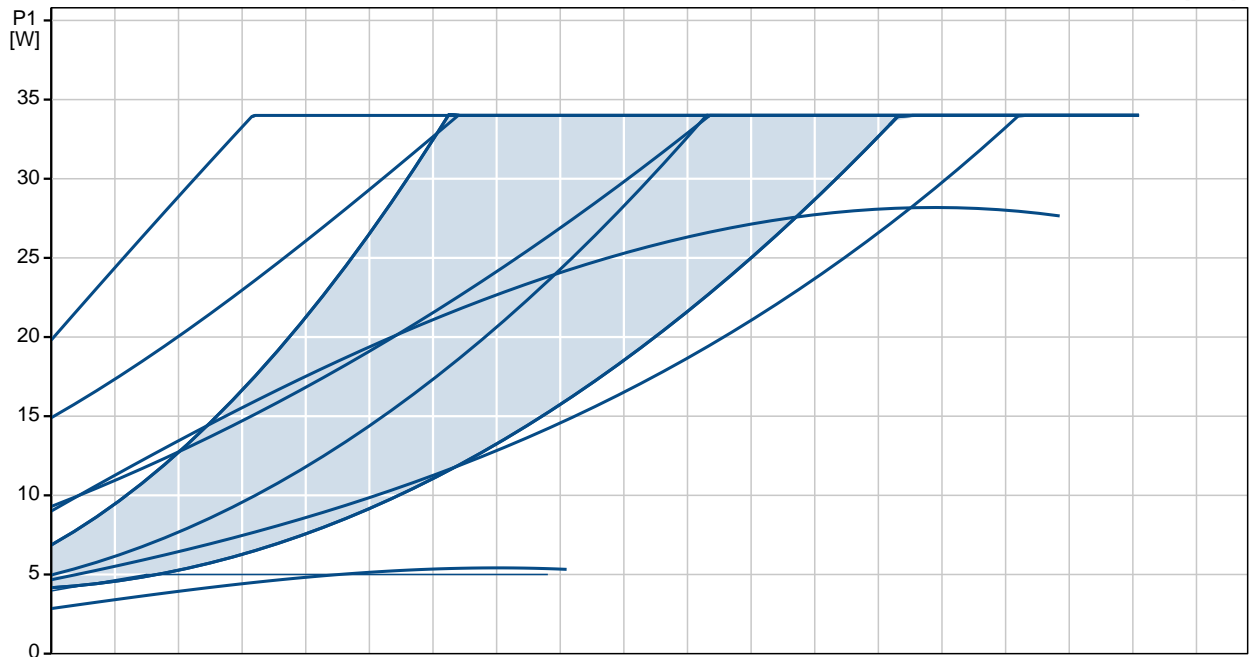
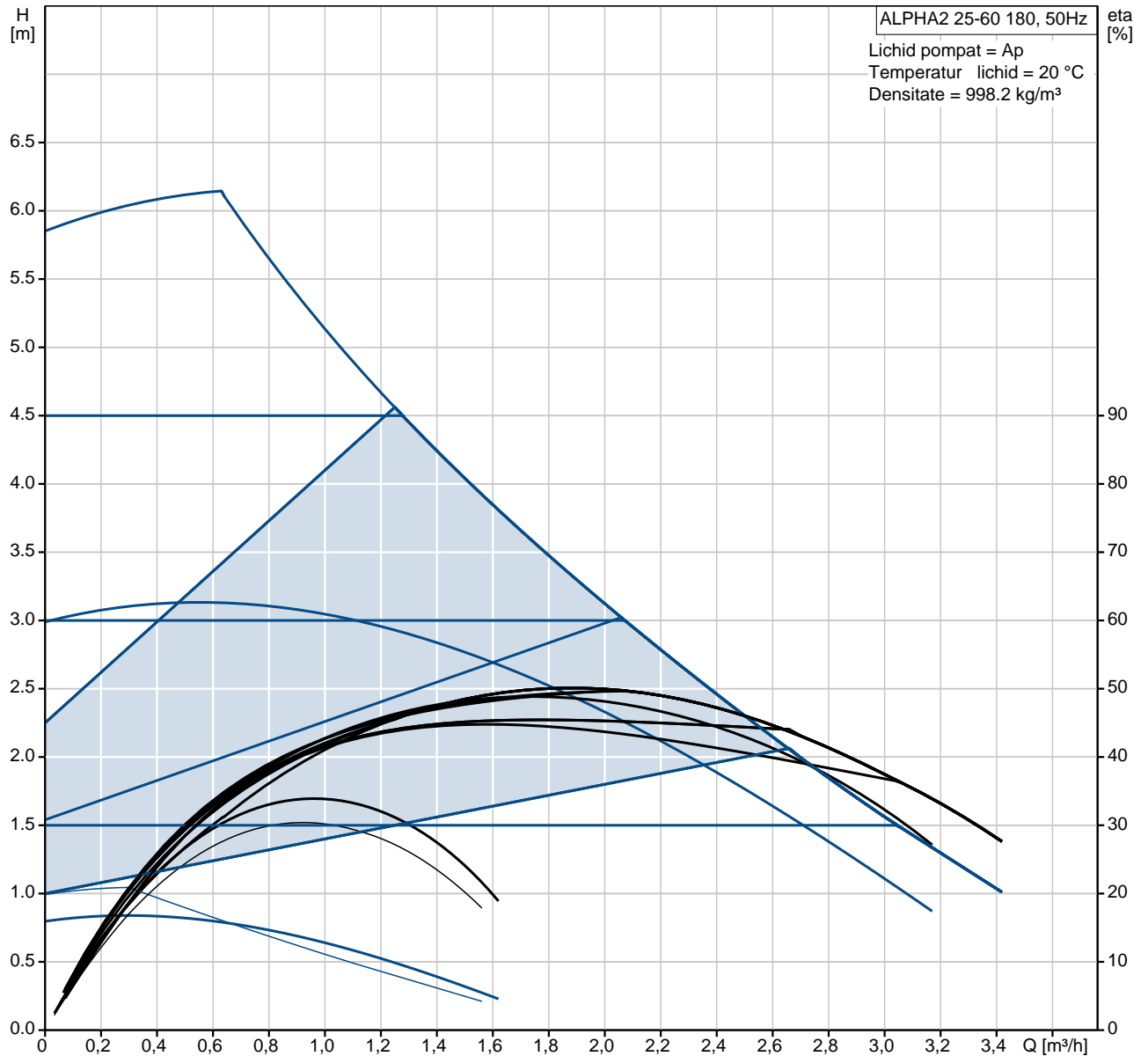

Descriere	Valori i tipuri
Nume produs:	ALPHA2 25-60 180
Nr. produs:	97993201
Num rul EAN:	5710627540401
Technical:	
În l ime de pompare max.:	60 dm
Clasa TF:	110
Aprob ri pe etichet :	VDE,GS,CE
Materials:	
Corpul pompei (stator):	Font EN-GJL-150 ASTM A48-150B
Rotor:	PES 30%GF
Instala ie:	
Gama temperaturii ambientale:	0 .. 40 °C
Presiune de func ionare maxim :	10 bar
Racordarea pompei la instala ie:	G 1 1/2
Presiune maxim de func ionare:	PN 10
Distan a dintre porturi:	180 mm
Liquid:	
Lichide pompate:	Ap
Gama temperaturii lichidului:	0 .. 110 °C
Temp. lichid:	20 °C
Densitate:	998.2 kg/m ³
Electrical data:	
Power input - P1:	3 .. 34 W
Curent consumat maxim:	0.04 .. 0.32 A
Frecven a re elei electrice:	50 Hz
Tensiune nominal :	1 x 230 V
Grad de protec ie (IEC 34-5):	X4D
Clas de izolare (IEC 85):	F
Tip protec ie motor încorporat :	F r
Protec ie termic :	ELEC
Controls:	
Automat noaptea:	func ionare redus automat pe timp te noapte inclus
Pozi ia cutiei de conexiuni:	6H
Others:	
Energy (EEI):	0.17
Greutate net :	2.01 kg
Greutate brut :	2.13 kg
Volum de transport:	0.004 m ³

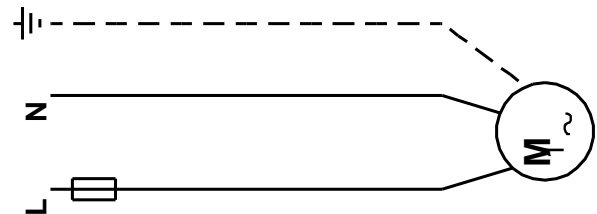
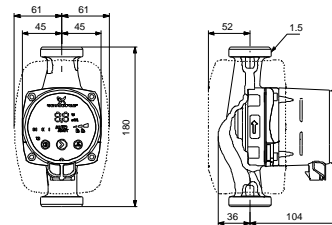
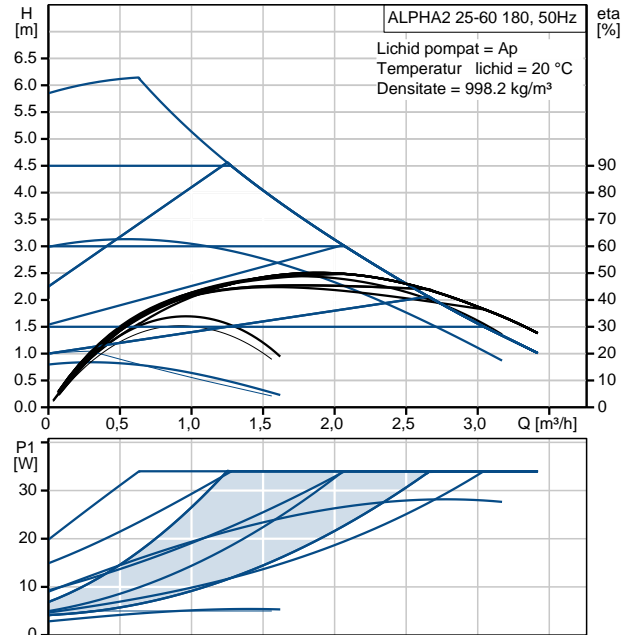

97993201 ALPHA2 25-60 180 50 Hz

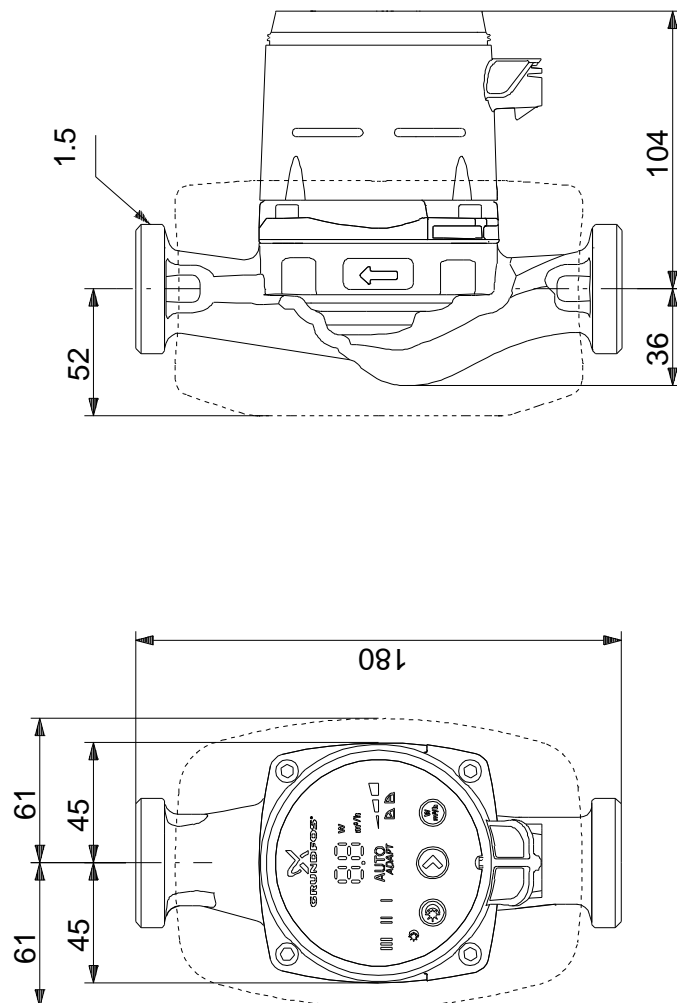

Note! All units are in [mm] unless others are stated.
Disclaimer: This simplified dimensional drawing does not show all details.

97993201 ALPHA2 25-60 180 50 Hz

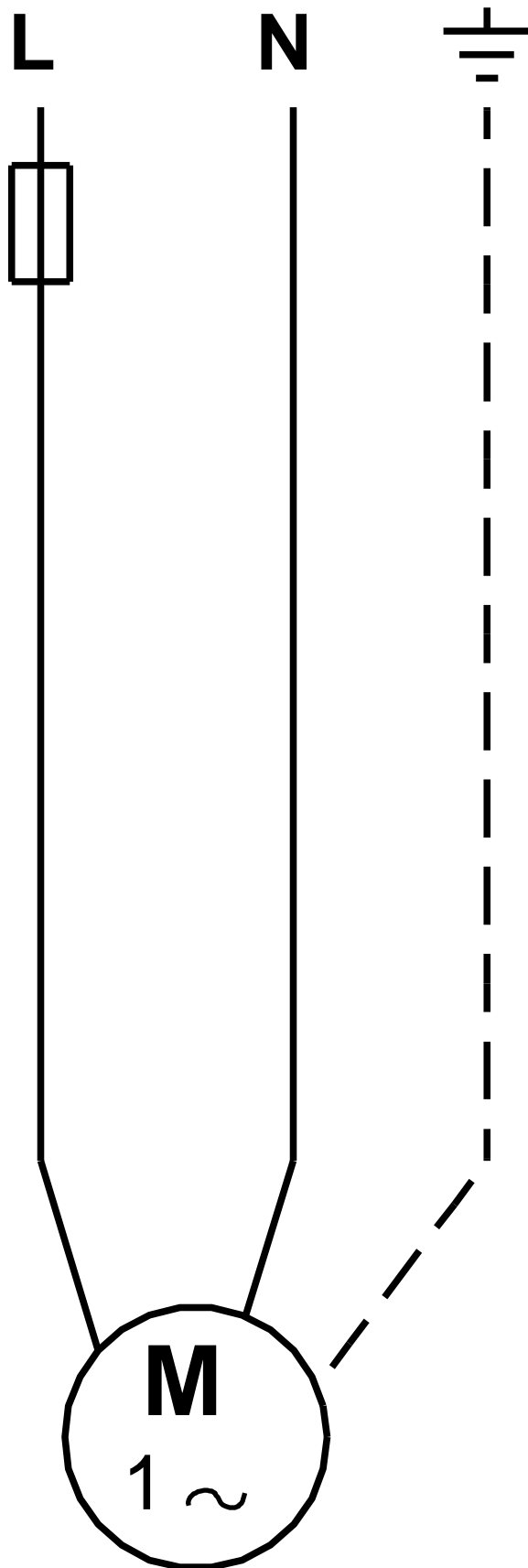

Not ! Toate unit ile sunt în [mm] dac nu altele sunt condi iile.