

FOR FOOD INDUSTRY

FOD ADDITIVES

- JARS
- CAPS
- SIEVES

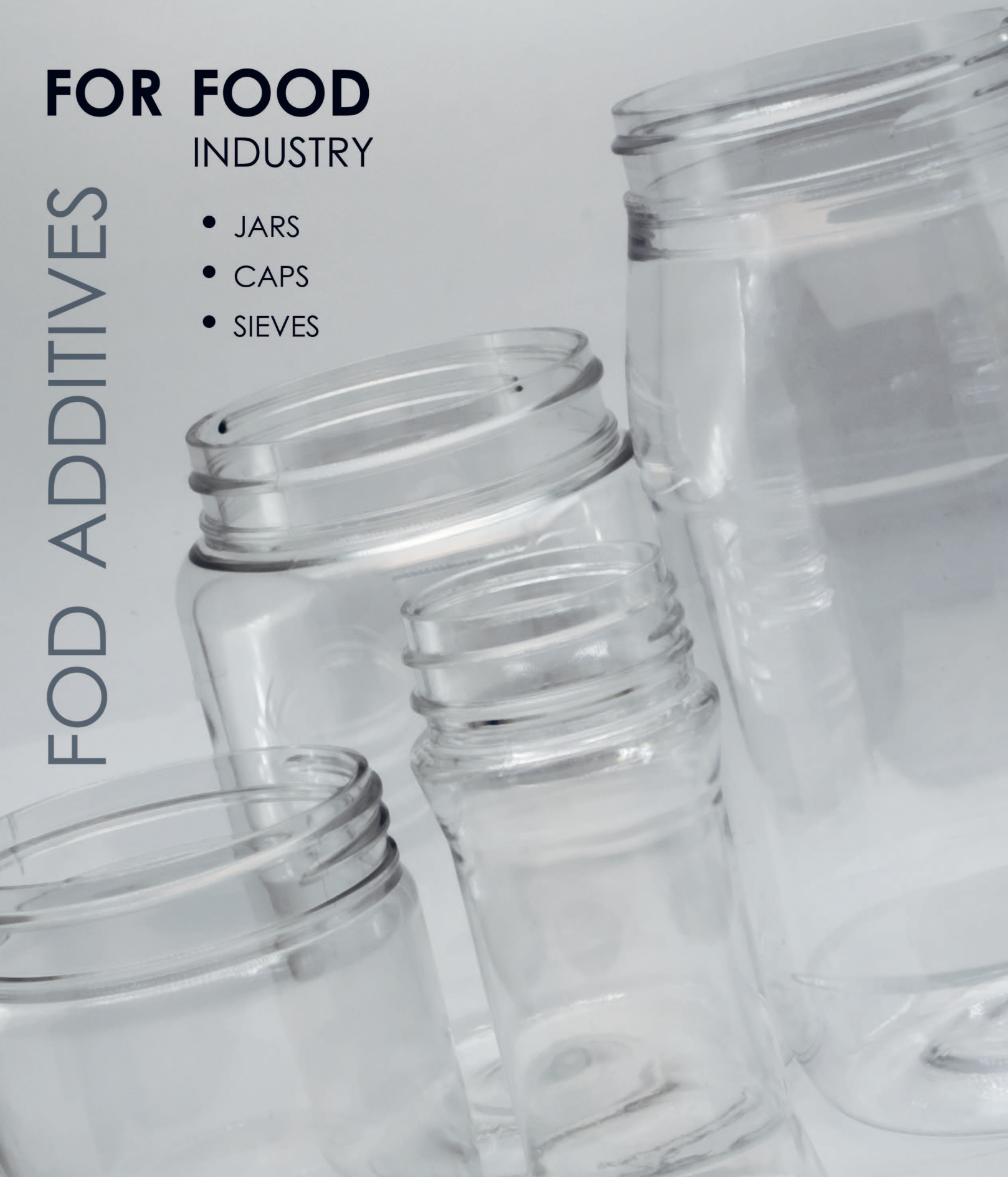

Jars for friable spices and flavoring spices. Jars with neck diameter of 38 mm and 63 mm. Caps and closures. Various types of sifters for convenient dispensing, and also closures with control of the first opening and without it.

Jar

BN.150

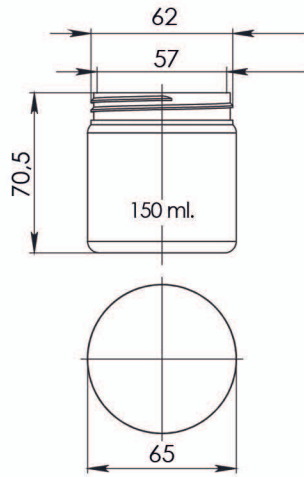

Jar

BN.250

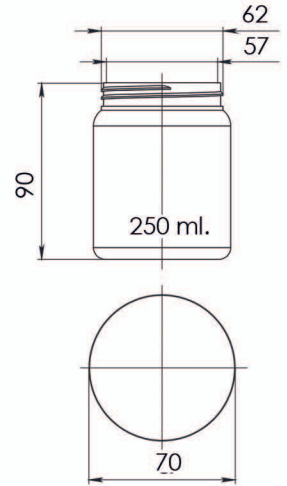

Jar

BN.400

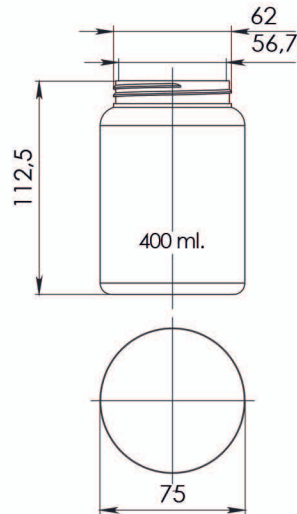

Jar

BN.500

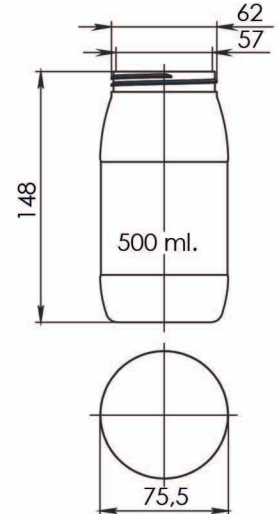

Cap

KN2-63

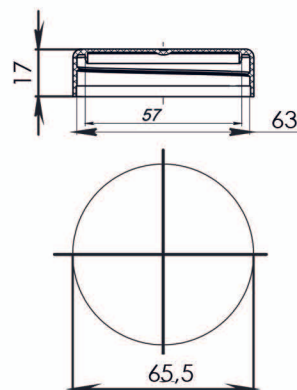

With sealing cone

Jar

«Classic»

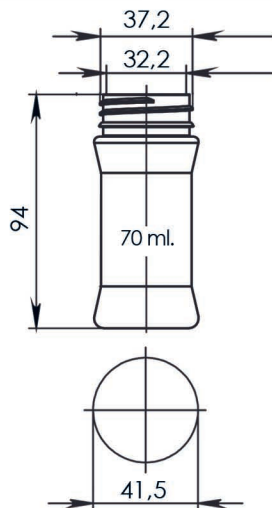

Code: BN.70/38-art.02

Jar

«Alvas»

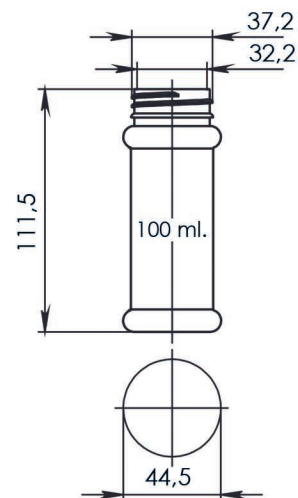

Code: BN.100/38-art.02

Cap

KN3-38

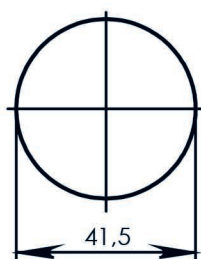
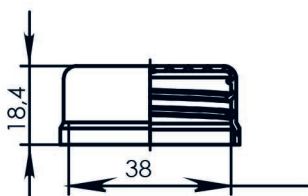

Cap

KN/K-38

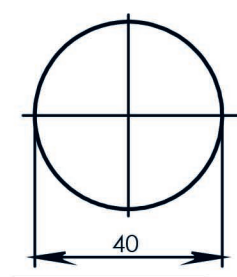
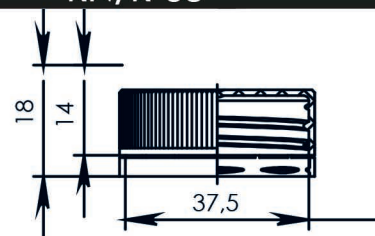

N/S-32

Sieve

