

SHARP

MX-2314N

Digital Full Colour Multifunctional System



Take the Full-Colour Plunge
with This Reliable, Compact Solution



COPY

NETWORK PRINT

NETWORK SCAN

SHARPEDESK

FAX
OPTION

Full-Colour Performance and Options to Build On

Move over B/W. Now's the time to step up document performance with a full-colour communications enhancer, the MX-2314N.

Compact and efficient, this A3 full-colour solution offers high-quality copying and network printing, convenient network scanning, and a B/W fax option. Optionally available USB direct printing, document filing, and previewing bring heightened performance, and the optional encryption/overwriting of data stored on the MFP's memory provides enhanced security. To boost productivity, there's a 100-sheet Reversing Single Pass Feeder, optional 500 + 2,000-sheet paper drawers, and a host of other business-supporting features. And to help the MX-2314N keep pace with your growing business, there's the Sharp OSA (Open Systems Architecture) option, an innovative development platform that opens the door to more advanced functions.

As added advantages, the MX-2314N boasts a space-saving frame and an environmentally friendly design that enables energy-efficient operation.



Style, Function, and Ease of Use

The MX-2314N was designed to complement the décor of any workplace. And a 7.0-inch WVGA touchscreen colour LCD—with optional thumbnail displays and data file previews—raises the bar on user friendliness and easy navigation. A retractable QWERTY keyboard option offers added convenience.



Thumbnails



Preview

Choice of Screen Style

The MX-2314N offers a choice of six LCD screen colours. While the default colour is black, users can easily select their preferred background style.



Breathtaking Image Quality

Sharp's second-generation Mycrostoner-HG and an improved imaging system combine to allow the full spectrum of colour reproduction in crisp, sharp detail. And because the MX-2314N is so easy to operate, breathtakingly high-quality images can be had with just the touch of a finger.

2nd-Generation Mycrostoner-HG



Auto Colour Mode

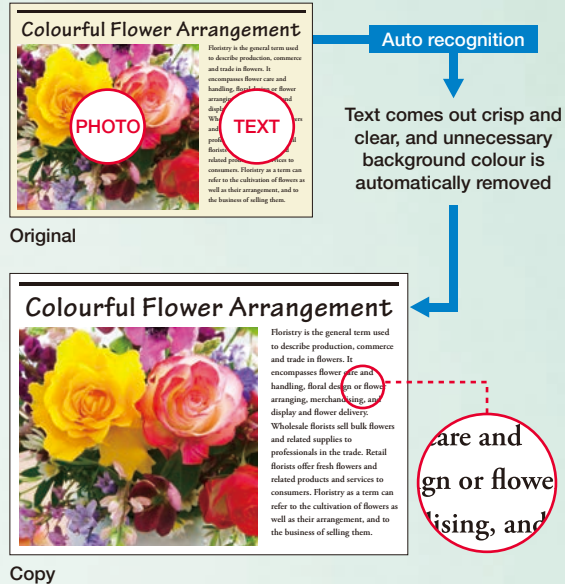

Sharpdesk Mobile – Keeping Pace with the Way You Work

As document demands increasingly move from out behind the desk to wherever business takes you, Sharpdesk Mobile*—an easy-access mobile print/scan application that connects Sharp MFPs to popular mobile devices via a wireless LAN connection—can help you keep pace. Documents scanned on a Sharp MFP can be sent to a mobile device running iOS or Android™ OS to preview and save. And documents saved on a mobile device can be printed out on the MFP, sent as e-mail attachments, or used in other applications. By combining the efficiency of Sharp MFPs and the convenience of mobile devices, Sharpdesk Mobile is adapting document usage to today's changing work styles. It's evolutionary!

* For details, see page 8.

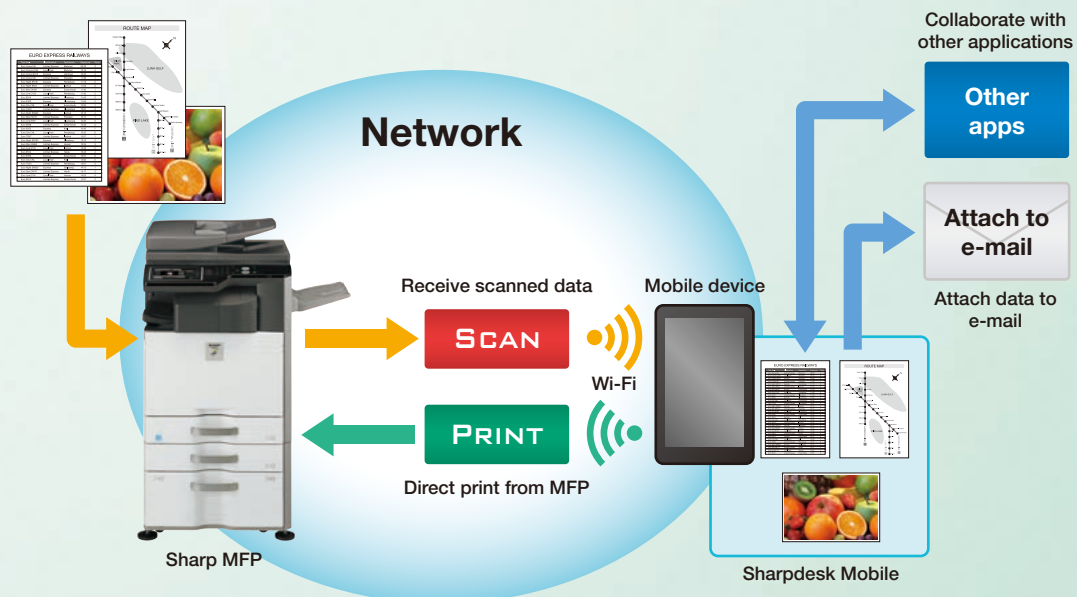



COPYING & NETWORK PRINTING

PRODUCTIVE

Super-Efficient Colour and B/W Output

The tandem printing engine with four in-line drums helps the MX-2314N deliver a fast output of **23 cpm/ppm*** in full colour and in B/W. And the first copy comes out in just **10.0 seconds** in full colour and **7.4 seconds** in B/W. What's more, its short, straight paper path minimises misfeeds to save you paper and toner costs.



* A4 (8 1/2" x 11"), long-edge feeding

Built-In Duplex Module

The MX-2314N can make **two-sided copies and printouts** using its built-in stackless duplex module, effectively reducing paper costs as well as saving filing space. Duplex copying is even more effective when the duplex module is used together with the standard-equipped **100-sheet**

RSPF (reversing single pass feeder), which efficiently feeds in one- or two-sided originals and can also simultaneously scan paper of different sizes.



Network Tandem Function*

When two MX-2314Ns are connected to the same office network, you can use both simultaneously to double copying/printing output to up to **46 cpm/ppm**. Large-volume jobs can be completed with ease, enabling you to meet tight deadlines.

* Requires optional MX-EB16.

Job Build for Large-Volume Scanning

The MX-2314N easily handles large-volume copy jobs exceeding the RSPF's 100-sheet*¹ capacity. For example, a 270-sheet original can be scanned as batches of 100 + 100 + 70 sheets and automatically stored on the MFP's hard disk*². Users can then print the entire document in a single run.

*1: A4 (8 1/2" x 11"), 80 g/m²

*2: Requires optional MX-EB16. The number of pages that can be stored for the Job Build function depends on the machine's HDD capacity and other conditions.

Proof Copying or Printing*

To prevent the waste of large-volume misprints, the MX-2314N lets users output only the first set to check the content, adjust settings if necessary, and then initiate output of the rest of the job from the LCD control panel.

* Requires optional MX-EB16.

Automated Finishing

The MX-2314N automates time-consuming finishing tasks and makes it easy to create professional-looking booklets. For a consistent, polished look, the **chapter divide** function prints documents so that all chapters begin on odd-numbered pages or all begin on even-numbered pages. A space-efficient **Finisher** is available for jobs that require sorting and stapling. And, an optional **Punch Module** allows you to punch holes in documents for easy filing.

Job Finishing Examples



Stapling



Hole punching



Extra Paper Capacity

For high-volume work, the MX-2314N can accommodate an optional stand with 500 + 2,000-sheet paper drawers for a total capacity of **3,100 sheets**.

When a tray runs out of paper, the **Auto Tray Switching** function automatically switches to another paper tray filled with the same size paper, allowing you to do extra-large volume jobs without worry.



Long-Paper (Banner) Printing*

The optional **Long Paper Feeding Tray** accommodates extra-long paper up to **1,200 mm**—expanding the range of print products to include panoramic pictures, large display-window ads, banner signs, and more.

* Contact a Sharp customer representative for details on using this function.



(Image)

NETWORK-READY

Supports Most Office Environments

- The MX-2314N works with the latest and most commonly used versions of Windows®, Windows Server®, and Mac operating systems and network protocols—including **IPv6**—even in mixed OS environments. You get fast, powerful network printing via the 1000Base-T **Gigabit Ethernet** standard.
- The MX-2314N supports the **PCL 6*** printer language. For compatibility with **PostScript 3**, the MX-PK11 PS3 Expansion Kit is available.

* Contact a Sharp customer representative about using PCL when MX-EB16 has not been installed.

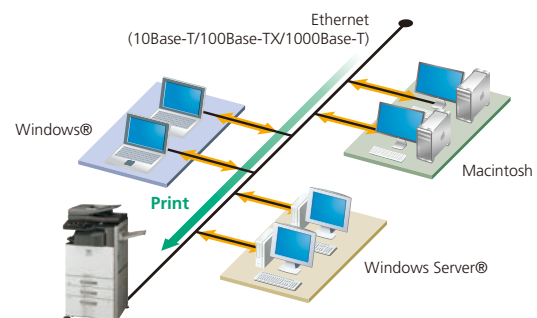

SUPERB IMAGE QUALITY

Improved Imaging System



Sharp thoroughly revamped its imaging process for the MX-2314N; now a high-performance processor, a new developer, and the **second-generation Mycrostoner-HG** (High Grade) combine to provide breathtaking image quality. The new toner expands the colour reproducibility range for a more natural rendering of clear blue skies, emerald green oceans, and other colour images. And the smaller particle size of the toner and the developer allows for reduced graininess and clear reproduction of fine lines, fine text, and halftone colours.



Crisp, Clear Text and Images



Employing digital smoothing technology enhances the print resolution to the equivalent of **9,600 x 600 dpi** for incredibly smooth reproduction of fine lines. Fine-grained photographs, detailed illustrations and graphs, and small text come out crisp and clear.

Easy, High-Quality Copying



Built to deliver automated, high-quality copying, the MX-2314N can reproduce maps with crisp, clear text and can remove unnecessary background colour from newspaper and magazine copies. Here's how it works: **Auto Colour Mode** analyses the contents of each page to distinguish between different components, such as photos and text, and then selects the appropriate copy mode for that page. **Auto Colour Selection** automatically determines whether a page is colour or B/W and then copies that page accordingly. And **Auto Exposure** automatically removes unnecessary background colour for clearer output.

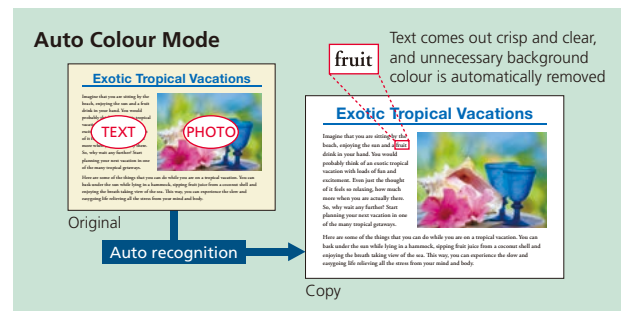

VERSATILE

USB Memory Direct Print*



One of the two USB ports on the MX-2314N is located at the front of the MFP beneath the control panel. It comes in handy when printing data directly from USB memory devices—an indispensable function for users who are in a hurry or who want quick machine access without a PC.

* Requires optional MX-EB16. Direct PDF printing additionally requires optional MX-PK11; direct XPS printing additionally requires optional MX-PUX1 and 2GB of extra memory.



Versatile Paper Handling



The MX-2314N accommodates a wide range of paper sizes, from **A5R (5 1/2" x 8 1/2"R)** to **A3 wide (12" x 18")**. You can do A3 (11" x 17") **full-bleed printing** onto **A3-wide (12" x 18")** paper, without loss of image area. And the MX-2314N can handle heavy paper stock up to **300 g/m²**, overhead transparencies, and other types of paper, further expanding the range of printing applications.

Image Editing Functions



The MX-2314N includes colourful editing functions made possible by digital technology.

- **Photo Repeat** places multiple copies of an image onto a single sheet.
- **Mirror Image** makes a reverse image of the original.
- **XY Zoom** adjusts the horizontal and vertical ratios independently.
- **B/W Reverse** reverses the black and white of an image.

Other Key Features



Copy & Print

- **Watermark*** prints a user-selected watermark, such as "Urgent," on each page to indicate the status of the document.
- **Tab Copy / Tab Print** can copy or print directly onto tabs on document separators and insert them into assigned positions.
- **Multi-Shot** copying and **N-up** printing
- **Pamphlet Style** copying/printing
- **Multi-Page Enlargement** copying/printing
- **Cover/transparency** insertion

* Requires optional MX-EB16.

Print

- **Direct Print**1** allows **PDF**2**, **TIFF**, **JPEG**, or **XPS**3** files to be printed without using the printer driver or opening applications.
- **Carbon Copy Print** mode automatically outputs multiple printouts of the same data on plain and/or coloured paper; convenient for invoices and purchase orders.
- **Form Overlay**4** can store office document formatting such as letterheads and overlay contents in colour, eliminating the need for pre-printed paper.
- **Barcode font** compatibility**5

*1: Direct printing may not support all PDF, TIFF, JPEG, and XPS formats. *2: Direct PDF printing requires optional MX-PK11. *3: Direct XPS printing requires optional MX-PUX1 and 2GB of extra memory. *4: Requires optional MX-EB16. *5: Requires optional MX-PF10.

Copy

- **Book Copy** is convenient for compiling copies of a book or bound originals into pamphlet format.
- **Card Shot** enables easy copying of both sides of a card (credit cards, ID cards, etc.) onto a single page.
- **Colour Stamp** labels your copies with page numbers, the date or text such as "Urgent" in up to four different colours.
- **Mixed Size Original Copy** mode automatically distinguishes documents of mixed sizes* (such as A3/B4, B4/A4, etc.) fed through the RSPF and chooses the appropriate paper.

* Some restrictions apply when combining paper sizes of different format series.



IMAGE SENDING

: Scan : Fax

A3 Colour Network Scanning

The MX-2314N works as a **full-colour network scanner** and supports TIFF, PDF, encrypted PDF, XPS, JPEG, and PDF/A file formats. Converting any type of paper-based document, up to A3 (11" x 17") in size, into an editable digital file is as easy as making a copy. Enhanced scan performance improves the legibility of extremely fine text and allows vivid colour reproduction in scanned documents. And **Auto Colour Selection** chooses the right mode for scanning originals containing both colour and B/W pages (see page 4).

Quick Scanning

For both colour*¹ and B/W documents, the MX-2314N carries out scanning at **50 opm***² (originals per minute) and can complete large scan jobs with ease and efficiency.

*1: Faxing is available in B/W only. *2: Single-side scanning

Skip Blank Page Function

When scanning and sending a multi-page document, the MX-2314N automatically recognises and skips over any pages without content, reducing both data size and transmission time.

Multiple Distribution of Scanned Files

With the touch of a few on-screen buttons, you can choose different ways to distribute your scanned documents. **Scan to E-mail** sends documents as an e-mail attachment. **Scan to FTP Server** scans documents directly to an FTP server for storage. **Scan to Desktop** sends scanned documents directly to your PC desktop. **Scan to Network Folder (SMB)** sends files to a shared folder on a networked Windows PC. **Scan to USB Memory** scans documents directly to USB memory devices. And **Scan to Fax** enables conventional faxing or Internet faxing.

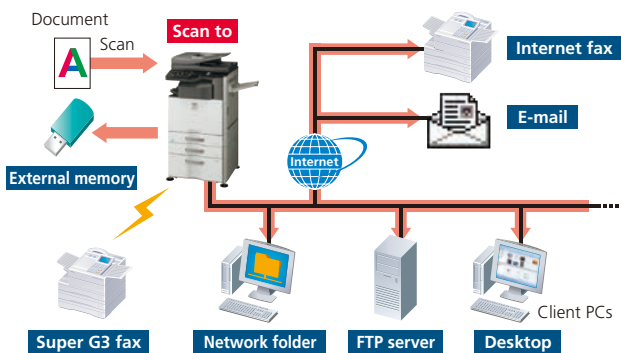

LDAP Support

Built-in LDAP (lightweight directory access protocol) support eliminates the need to enter or register full addresses. By entering the first few letters of the recipient's name, the MX-2314N displays a list of possible matches from your company's LDAP server. Selected addresses can be stored to the MX-2314N's address book.

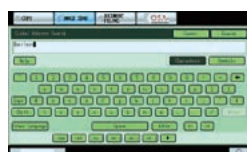

High-Speed Faxing

The optional MX-FX11 Fax Expansion Kit turns the MX-2314N into a 33.6 Kbps **Super G3 fax** machine. Quick On-Line Transmission initiates dialling and transmitting as soon as a page is scanned into memory. JBIG compression technology lets the MX-2314N send an A4 (8 1/2" x 11") size page in under three seconds*. And using the 100-sheet RSPF gives faxing efficiency a further boost. Incoming faxes are also handled with automated ease. The number of copies to be made can be specified on the LCD control panel's Fax Output setting, and optional finishing options can be installed for automatic stapling of those copies.

* Based on Sharp's standard chart with approximately 700 characters (A4 or 8 1/2" x 11" long-edge feeding) at standard resolution.

PC-Fax/PC-Internet Fax

Directly send a document created on your PC to a recipient's fax machine via a phone line or the Internet without printing to paper. Save time and paper costs while retaining original document quality.

Note: PC-Internet Fax requires optional MX-EB16 and MX-FWX1; PC-Fax requires MX-FX11.

Internet Fax

Economically send and receive faxes to and from other ITU-T T-37-compliant Internet fax machines via the Internet. The MX-2314N supports **Direct SMTP**; outgoing Internet faxes do not go through your mail server, making transmission faster and cheaper.

Note: Requires optional MX-EB16 and MX-FWX1.

Paperless Faxing with Inbound Routing

Paperless faxing with inbound routing lets you check incoming faxes via e-mail before printing. It can also forward incoming faxes to another fax/Internet fax machine, an FTP server, a network folder (SMB), or a PC desktop. Files can be saved in either PDF or TIFF (single/multi).

Note: Requires optional MX-EB16 and MX-FX11 or MX-FWX1.

Other Key Features

Scan & Fax

- **One-touch auto dial keys** register up to **1,000** numbers for frequently used destinations
- **Broadcast transmission** to up to 500 destinations
- **Program keys** (up to 48 keys) are available to set up frequently used transmissions for instant recall
- **Easy text entry*** lets you enter addresses, file names, subject titles or messages from the LCD control panel
* Only addresses can be entered for faxing.
- **Mixed size original scanning** automatically distinguishes documents of mixed sizes fed through the RSPF

Fax

- **Duplex transmission/reception** sends and prints out two-sided documents
- **SD memory card backup** ensures documents remain safely backed up in memory, even in the event of a power failure
- **Rotation transmission/reception** rotates incoming and outgoing faxes to match the direction of the printing paper
- **Fax destination confirmation** allows users to reconfirm fax numbers before sending to prevent transmission errors

SECURITY

Industry-Leading Multi-Layered Security

Designed to protect your business assets and bring you peace of mind, Sharp's industry-leading security solutions employ multiple levels of security functions covering a broad range of network and data security needs. The MX-2314N safeguards sensitive data with powerful, enhanced security functions that eliminate the worry of unauthorised use and guarantee greater protection for your confidential information.

Data Encryption and Overwriting

Digital copier/printers and MFPs can retain hundreds of pages of confidential information from previous jobs on their hard disks or internal memory. To safeguard such information from unauthorised access, the MX-2314N automatically **encrypts** document data stored on the hard disk and in the address book. Standard-equipped security features also provide up to seven automatic **overwrites** of data generated for each job, **password protection** of Document Filing data, and more.

Note: Requires optional MX-EB16. Contact a Sharp customer representative for details on activating these security functions.

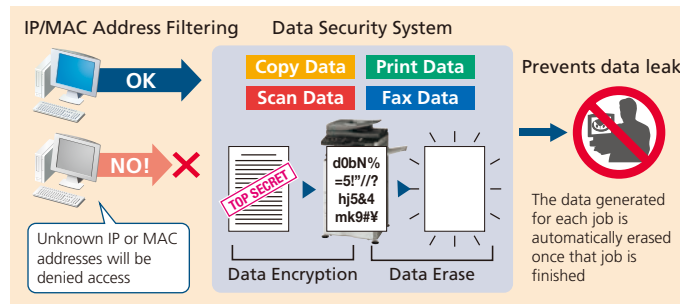

Secure Network Access

The **IP/MAC address filtering** function provides highly secure operation by restricting access to the MFPs on your office network. Only PCs that have either their IP address or MAC (media access control) address registered are allowed to use the MFPs.

Attempted access from an unknown IP or MAC address will be denied, preventing unauthorised use. The MX-2314N also supports the **IEEE 802.1X** standard for port-based network access control, which blocks all access from unauthorised devices.

Document Control Function

Document Control prevents unauthorised copying, scanning, faxing, and filing of confidential documents by embedding copy prevention data onto a document. When that data is detected, any unauthorised attempts to copy will be cancelled or will result in only blank-page output.

Note: Requires optional MX-EB16 and MX-FR40U. May not work for certain types of documents or paper.

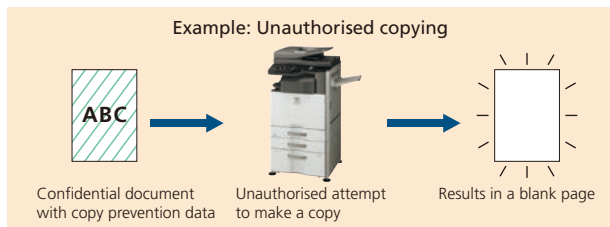

Encrypted PDF with Password Protection

To prevent unauthorised viewing of confidential data, the MX-2314N enables scanned PDF data to be password protected and encrypted for transmission over the network. After transmission, viewers can gain access to the encrypted PDF only after re-entering the password.

Note: Direct printing of encrypted PDF files requires optional MX-EB16.

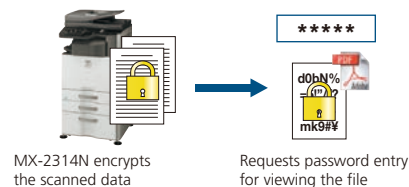

Secure Sockets Layer

SSL (secure sockets layer) enables the encryption of data communications to prevent data leakage through the network when printing via IPP, browsing secure Web pages (HTTPS), or communicating via e-mail (SMTP and POP3) or FTP (FTPS).

IPv6 and IPsec Support

The MX-2314N supports the **IPv6** Internet protocol. An obligatory part of IPv6 is **IPsec** (IP Security), a set of protocols for securing Internet protocol (IP) communications. IPsec encrypts and authenticates traffic between specified parties, giving IPsec-compatible products an extremely high level of network security.

User Authentication

The MX-2314N prevents unauthorised use by requiring **passwords** for machine access. This safeguarded solution can register up to 1,000 users in **three access levels** as Administrator, User, or Guest and can designate to which function user authentication applies. The MX-2314N can, for example, be set to allow B/W copying by all users while restricting colour copying to designated users. And the MX-2314N works with an **external Active Directory server** to extend user authentication to multiple MFPs and a greater number of users.

Scan to Me Function

Scan to Me lets a logged-in authorised user send scanned data to his/her own e-mail address simply by pressing the start button. This eliminates the need to manually enter or select the address, thereby preventing documents from being sent to the wrong address.

Data Initialisation

The MX-2314N's initialisation function allows confidential information to be erased at the administrator's discretion via the MFP's system setting. Initialising an MFP when it's time to replace it prevents important resources, such as customer information and intellectual property, from leaking out and provides considerable peace of mind.

DOCUMENT MANAGEMENT

Document Management on the Hard Disk

You can save processed job data in designated folders on the MX-2314N's hard disk, making it easy to instantly recall saved documents or jobs for printing and sending at a later time. This contributes greatly to efficient sharing and distribution of information in your business operations.

Note: Requires optional MX-EB16.

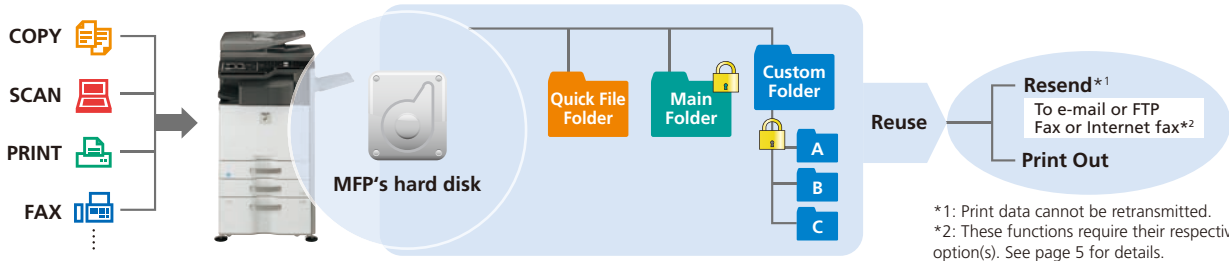

*1: Print data cannot be retransmitted.
*2: These functions require their respective option(s). See page 5 for details.

Quick Filing

Up to **10,000 pages** or 1,000 files*³ that have been copied, printed, scanned, or faxed*⁴ can be stored by job in a Quick File Folder. You can easily reuse saved data without having to reload or rescan the original.

Advanced Filing Function

Up to **20,000 pages** or 3,000 files*³ that have been copied, printed, scanned, or faxed*⁴ can be stored by job on the hard disk in up to 1,000 folders with customised names and locations. Enhanced security features require users to enter a 5- to 8-digit password to access secure folders, protecting your sensitive data. Storage options include Main Folder for workgroup sharing and Custom Folder for enhanced-security archiving.

*3: Storage capacity will vary depending on the type of document and the scan settings.

*4: For fax and Internet fax jobs, only transmitted data (not received faxes) can be saved in the Document Filing function.

Easy Access to Stored Files

Documents stored on the hard disk can be quickly and easily searched and accessed from the control panel's LCD via thumbnail displays and file previews or through a Web browser.

Note: Requires optional MX-EB16.



Search results

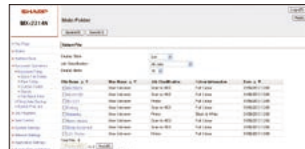

Web access screen

Easy Sharing of Application Files

To facilitate file sharing across the office network, the MX-2314N provides 120GB of hard disk storage space for folders. Each folder can hold up to 500 files created with applications such as Word and Excel® and saved in their original format.

Note: Requires optional MX-EB16.

(Backing up data saved to the MFP's hard disk is recommended.)



Sharpdesk for Total Document Management

Sharpdesk is an original Sharp application that provides integrated desktop management of documents in over **200 file formats**, including scanned paper-based documents and those created with popular applications such as Word. With Sharpdesk, documents can be organised, edited, searched, and distributed with simple drag-and-drop operation. Features include **thumbnail** viewing, **annotation** tools for paper-free proofreading, optical character recognition, the ability to combine different types of files into a single document, and more.

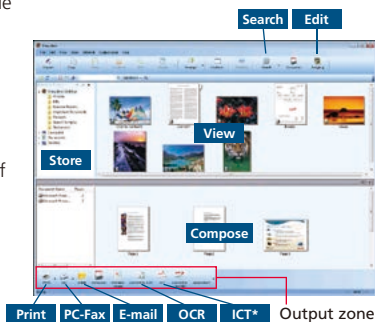

* Image Compression Tool for converting images into compact PDF files

Sharp OSA Network Scanner Tool

This client-based scan-to-desktop option is the ideal document management system for small workgroups or offices that don't have servers. Sharp OSA Network Scanner Tool provides centralised scan/print user profiles to give everyone in the office easy one-touch scanning to their PC from any networked MFP—without complicated settings. Scanned documents can be quickly and easily printed, filed, previewed, shared, and stored to save time and improve document workflow. And Sharp OSA Network Scanner Tool automatically names PDF files based on scanned-document titles and can convert scanned documents into text with the OCR engine to create searchable PDF files.

Note: Requires optional MX-EB16 and MX-AMX2.





DEVICE MANAGEMENT

Web-Based System Settings

Administrators can manage every important setting—including user access and security as well as other controls and configurations—through a standard Web browser right from their desktops.



Web-based device management

Network Utility Software

Sharp Remote Device Manager* (SRDM) gives administrators centralised control of their networked MFPs through a standard Web browser, making device cloning and other operations easier and more accessible.

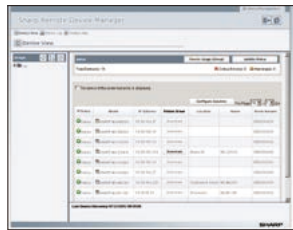

Web-based SRDM

* Contact a Sharp customer representative for details on using this function.

Remote Diagnosis

The MX-2314N can be monitored remotely through a Web browser, letting administrators handle tasks before they become problems. And when action or maintenance is required, the **E-Mail Status and Alert** function notifies administrators via timely e-mail alerts.

Remote Operation

The Remote Operation function lets you display the MFP's main control panel on your PC screen, allowing you to operate every major function directly from your desktop.* This function also enables the administrator to guide an MFP user through necessary procedures and allows remote MFP operation from a wheelchair.

* Requires VNC application.



Device Cloning

Machine settings can be copied conveniently to another MX-2314N via a Web browser in XML format, making it easy to clone machines in a networked environment. With Device Cloning, the administrator no longer needs to set up individual machines one by one, thereby making his/her job a lot easier.

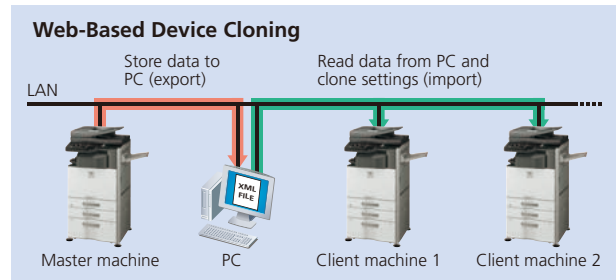

EXPANDABILITY

Sharp OSA* (Open Systems Architecture)

Innovative Sharp OSA technology allows you to interact with critical business and network applications right from the LCD control panel, offering a new realm of control and convenience. And since Sharp OSA utilises industry-standard network protocols, the MX-2314N can easily integrate with document management systems, enterprise resource planning software, workflow applications, and more. The latest version of Sharp OSA can **reach beyond the firewall**, enabling extensive system construction and services over the Internet. Sharp OSA brings benefits such as reducing the costs associated with system implementation and management, as well as enabling data sharing across company branch offices or subsidiaries.

* Requires optional MX-EB16 and MX-AMX2 and/or MX-AMX3.

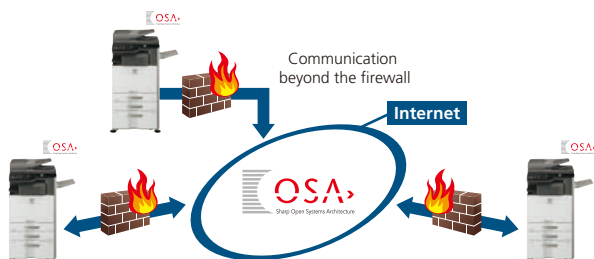

Sharpdesk Mobile

Sharpdesk Mobile is a mobile print/scan application that combines the convenience of mobile devices and the efficiency of Sharp MFPs to make conducting business on the go easier than ever. Documents scanned on a Sharp MFP can be sent to a mobile device running iOS or Android OS to preview and save. Documents saved on a mobile device can be printed out on the MFP, sent as e-mail attachments, or used in other applications.

Notes on Sharpdesk Mobile:

- This application can be downloaded for free from the Apple App Store for iPad and iPhone or from Google Play™ for Android devices.
- Supported devices: iPhone 4, iPhone 4S, iPad, iPad 2, and iPad (3rd generation) running iOS 4.3, 5.0, 5.1, or 6.0, and Android-based mobile devices running Android 2.3 or 4.0 (SD memory card required for some devices; recommended screen resolution of 800 x 480 pixels or higher).
- Availability varies by country/region. For details, see the Sharpdesk Mobile support Web site: http://sharp-world.com/products/copier/docu_solutions/mobile/sharpdesk_mobile/

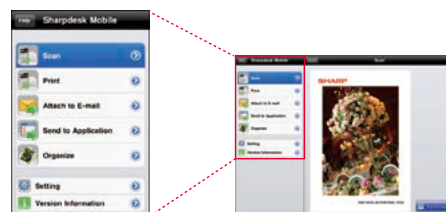

Top menu screen (image)

Preview of scanned data (image)



EASE OF USE

7.0-Inch Touchscreen LCD

The MX-2314N features a logically designed control panel with a wide, clear, WVGA-resolution touchscreen LCD. Easy-to-follow guidance puts step-by-step instructions on the LCD to guide you through all the necessary procedures for staple/sort finishing, pamphlet making, and other functions. Pushing the **Home** button, even in the middle of an operation, takes you back to the Start screen. Programming the most frequently used functions and settings into **My Menu** gives you quick and easy access to them. And using the included stylus pen provides controlled, accurate touchscreen operation.

Retractable Keyboard (option)

A **full-size retractable QWERTY keyboard** slides out from beneath the control panel to make text input fast and easy: convenient for typing things like e-mail addresses and messages, as well as passwords for user authentication.



Easy-Grip Handles

Easy-grip handles on the MX-2314N reflect a universal design that allows the paper drawers to be grasped from the top as well as the bottom for easy opening and closing.



Thumbnail Display and Previews*

Making the search for files easier and more convenient than ever, thumbnails and up-close previews of Document Filing data files, as well as conventional file names, can be displayed on the MX-2314N's LCD control panel. And to help users decide which documents to print out or forward to others, the LCD can also display thumbnails and previews of incoming faxes and Internet faxes. The MX-2314N even prevents errors in copying, scanning, or saving documents to its hard disk by showing previews of those jobs on the LCD before actually executing them, making it easy to confirm finishing options, scan settings, and other such items.

* Requires optional MX-EB16.

Job Status Screen

Whether printing or copying, the control panel displays a list of all jobs, showing you at a glance the jobs in progress and the position of your job in the queue. And, with a few quick touches of the LCD screen, the **Priority Printing** function lets you easily **change the job queue order** or delete jobs that are no longer needed.

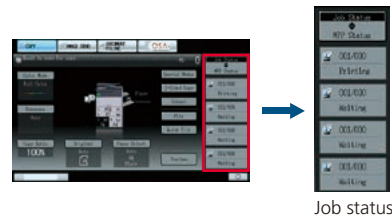

Job status



ENVIRONMENT-FRIENDLY

Outstanding Energy Efficiency

To reduce power consumption, Sharp has applied its advanced technologies across all areas of this MFP, including the hardware, software, electrical system, and supplies. As a result, the MX-2314N boasts one of the lowest power consumption rates in its class.

- Sharp's belt fusing system shortens the MX-2314N's warm-up time to **19 seconds**, contributing to reduced overall energy consumption.

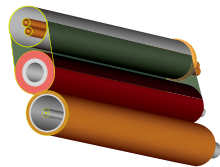

Sharp's belt fusing system

- **Power ON/OFF Schedule** function automatically turns the MX-2314N on or off according to time schedules set by the administrator.

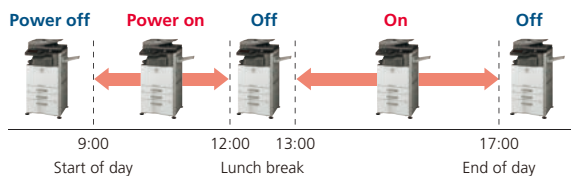

- Based on prior usage patterns, the MX-2314N automatically determines the optimal length of time to let elapse before going into **auto power shut-off mode**, helping reduce overall power consumption. Shortly before auto power shut-off mode begins, a message appears* on the LCD indicating that the MFP will soon shut down and giving users the option to continue operation.

* Contact a Sharp customer representative to activate this pop-up message function.

- **Eco Scan** function saves energy by keeping the fusing system shut down during jobs that don't require the use of the fusing system, such as Image Sending and Document Filing.
- Second-generation Mycrostoner-HG has a **lower melting point** than conventional toner, allowing fusing to be carried out with less energy. It also offers a significantly lower consumption rate than conventional toner.

- For further energy savings, energy-efficient **LED lamps** are employed in the scan unit in place of conventional xenon lamps. A new ASIC (application-specific integrated circuit) also helps the MX-2314N deliver excellent performance and energy efficiency.

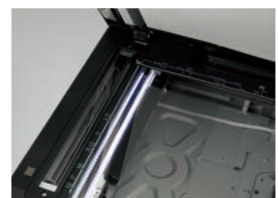

OPTIONS

System Configuration

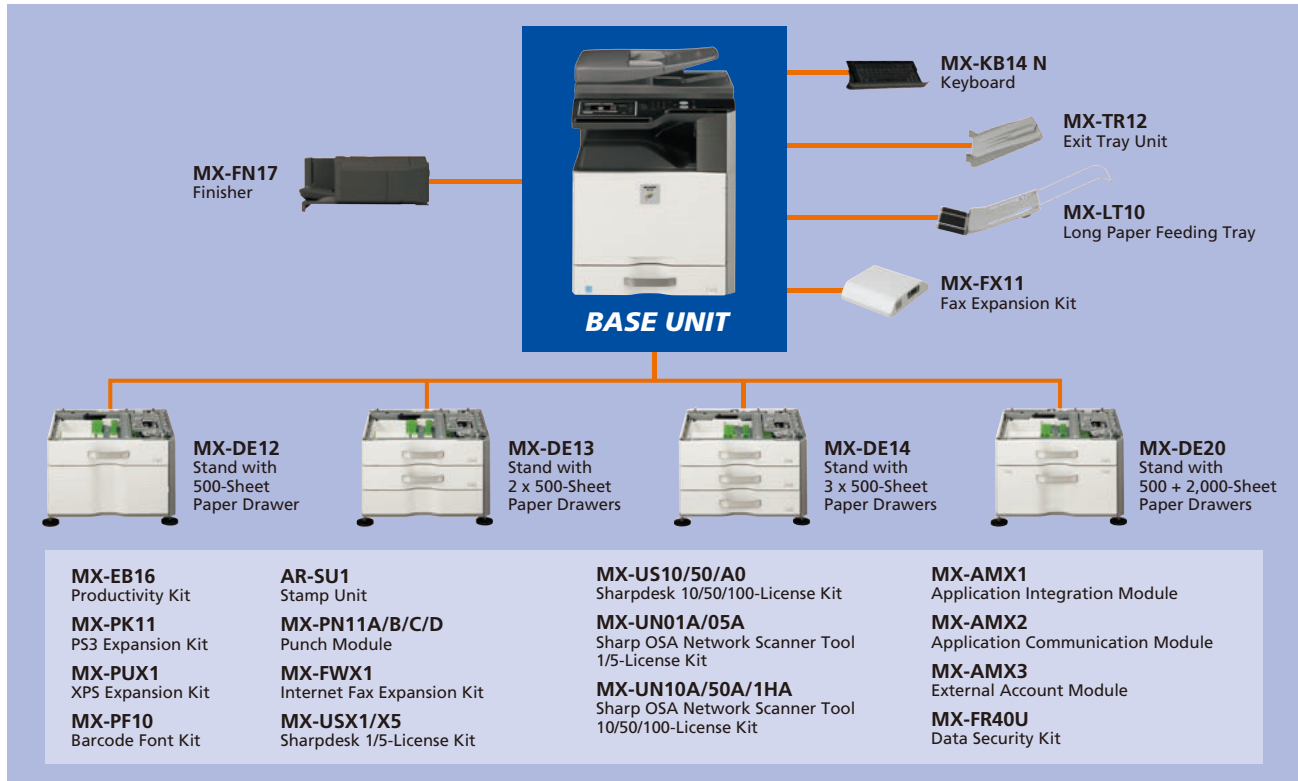

Certain options may not be available in some areas.

Specifications for Options

MX-FN17 Finisher

Paper size	Non offset Offset/staple	A3W to A5R (12" x 18" to 5 1/2" x 8 1/2"R) A3 to B5 (11" x 17" to 8 1/2" x 11"R)
Paper capacity		500 sheets (A4 or smaller), 250 sheets (B4 or larger)
Stapling capacity		50 sheets (A4 or smaller), 30 sheets (B4 or larger)
Staple position		3 locations (front, rear or both)

Punch Modules

Model name	For the MX-FN17	MX-PN11A	MX-PN11B	MX-PN11C	MX-PN11D
Number of holes		2	3	4	4 (wide)
Paper weight		55 to 256 g/m ² *			

* Guaranteed punchable weight is 55 to 128 g/m².

MX-FX11 Fax Expansion Kit

Compression method	MH/MR/MMR/JBIG
Communication protocol	Super G3/G3
Modem speed	33,600 bps to 2,400 bps

MX-DE12 Stand with 500-Sheet Paper Drawer

Paper size	A3 to A5R (11" x 17" to 5 1/2" x 8 1/2"R)
Paper capacity	500 sheets (80 g/m ²)

MX-DE13 Stand with 2 x 500-Sheet Paper Drawers

Paper size (upper/lower tray)	A3 to A5R (11" x 17" to 5 1/2" x 8 1/2"R)
Paper capacity (upper/lower tray)	500 sheets each (80 g/m ²)

MX-DE14 Stand with 3 x 500-Sheet Paper Drawers

Paper size (upper/middle/lower tray)	A3 to A5R (11" x 17" to 5 1/2" x 8 1/2"R)
Paper capacity (upper/middle/lower tray)	500 sheets each (80 g/m ²)

MX-DE20 Stand with 500 + 2,000-Sheet Paper Drawers

Paper size (upper tray)	A3 to A5R (11" x 17" to 5 1/2" x 8 1/2"R)
(lower right/left tray)	A4 (8 1/2" x 11")
Paper capacity (upper tray)	500 sheets (80 g/m ²)
(lower right tray)	850 sheets (80 g/m ²)
(lower left tray)	1,150 sheets (80 g/m ²)

MX-LT10 Long Paper Feeding Tray

Paper size	Max. 1,200 mm long
Paper capacity	1 sheet (80 g/m ²)

Sharpdesk System Requirements

Supported OS*	Windows® XP (SP2) Professional/Home Edition, Windows Vista®, Windows® 7
Hard disk	Minimum requirement of operating system used plus at least 500MB to store Sharpdesk and Network Scanner Tool programmes
CPU	Pentium® or equivalent processor (Windows XP: 800 MHz 32-bit/64-bit processor; Windows Vista and Windows 7: 1 GHz 32-bit/64-bit processor)
Memory	Windows XP: 512MB RAM; Windows Vista and Windows 7: 1GB RAM/2GB RAM (Windows 7 64-bit)
Monitor	Windows XP: SVGA display; Windows Vista and Windows 7: Direct X9 support with 128MB video RAM

* Contact a Sharp customer representative about compatibility with Windows® 8.

Sharp OSA Network Scanner Tool System Requirements

	Host PC	Client PC
Supported OS*1	Windows® XP Professional (SP3 or later; 32-bit); Windows Vista® Business, Enterprise, or Ultimate Edition (SP2 or later; 32-bit or 64-bit) Windows® 7 Professional, Enterprise, or Ultimate Edition (32-bit or 64-bit)	Windows® XP Home (SP3 or later; 32-bit) Windows Vista® Home Basic or Home Premium (SP2 or later; 32-bit or 64-bit) Windows® 7 Home Basic or Home Premium (32-bit or 64-bit)
Hard disk and memory	2GB RAM	
	1GB available hard disk space (work space is also required)	400MB available hard disk space (work space is also required)
Other	.NET Framework 3.5 (SP1); Microsoft Internet Explorer (XP: 6.0 or later)	
	Internet Information Services 5.1 or later; TCP/IP networking with no DHCP	Sharpdesk v3.3 or later*2; TCP/IP networking (with or without DHCP)

*1: Contact a Sharp customer representative about compatibility with Windows Server® 2012 and Windows® 8.

*2: The following functions cannot be used without Sharpdesk installed on the client PC: Some scan/print default profiles for Sharpdesk; thumbnail view (except image files); scan/print previews (except image files); advanced search; compressed PDF

Note: When using Sharp OSA, please ask your Sharp customer representative about PC system requirements.

SPECIFICATIONS

General

Type	Desktop
Engine speed (colour & B/W)	Max. 23 cpm/ppm (A4, 8 1/2" x 11", long-edge feeding)
Paper size	Max. A3 wide (12" x 18"), min. A5R (5 1/2" x 8 1/2" R)
Paper capacity (80 g/m ²)	Standard: 600 sheets (500-sheet tray and 100-sheet multi-bypass tray) Maximum: 3,100 sheets
Paper weight	Tray: 60 g/m ² to 220 g/m ² (16 lbs bond to 80 lbs cover) Multi-bypass tray: 55 g/m ² to 300 g/m ² (13 lbs bond to 110 lbs cover)
Warm-up time*1	19 sec.
Memory	[Standard] Copy/print (shared): 2GB [Option] Print: 3GB 320GB HDD*2
Power requirements	Rated local AC voltage ±10%, 50/60 Hz
Power consumption (max.)	1.84 kW (220 to 240V)
Dimensions (W x D x H)	583 x 642 x 834 mm (22 31/32" x 25 9/32" x 32 53/64")
Weight (approx.)	72.6 kg/160.1 lbs (220 to 240V)

Copier

Original paper size	Max. A3 (11" x 17")
First copy time*3	Full colour: 10.0 sec. B/W: 7.4 sec.
Continuous copy	Max. 999 copies
Resolution	Scan (colour): 600 x 600 dpi Scan (B/W): 600 x 600 dpi, 600 x 400 dpi, 600 x 300 dpi Print: 600 x 600 dpi; 9,600 (equivalent) x 600 dpi (depending on print mode)
Gradation	Equivalent to 256 levels
Zoom range	25 to 400% (25 to 200% using RSPF) in 1% increments
Preset copy ratios	Metric: 10 ratios (5R/5E), inch: 8 ratios (4R/4E)

Network Scanner

Scan method	Push scan (via control panel), pull scan (TWAIN-compliant application)
Resolution	Push scan: 100, 200, 300, 400, 600 dpi Pull scan*4: 75, 100, 150, 200, 300, 400, 600 dpi 50 to 9,600 dpi via user setting*5
File formats	TIFF, PDF, PDF/A, encrypted PDF, JPEG (colour only), XPS*6
Scanner utilities	Sharpdesk, Sharp OSA Network Scanner Tool
Scan destinations	Scan to e-mail/desktop/FTP server/network folder (SMB)/ USB memory

*1: At rated voltage, 23°C (73.4°F). May vary depending on operating conditions and environment.
 *2: HDD capacity depends on procurement and sourcing status.
 *3: Long-edge feeding of A4 (8 1/2" x 11") sheets from 1st paper tray, using document glass, without Auto Colour Selection and Auto Colour mode, MFP in fully ready condition. May vary depending on operating conditions and environment.
 *4: Optional MX-EB16 required.
 *5: Resolutions higher than 600 dpi are interpolated.
 *6: To view XPS files on PCs not running Windows Vista, you must have the XPS Viewer application installed.
 *7: Storage capacity will vary depending on the type of document and the scan settings.
 *8: Some features require option(s).
 *9: Optional MX-PK11 required for Mac OS and EtherTalk.
 *10: As print performance may decrease depending on the type of data, Sharp recommends installing the optional MX-EB16 for optimal MFP performance.
 *11: PS requires optional MX-PK11. XPS requires optional MX-EB16, MX-PUX1 and 2GB memory.
 *12: Based on Sharp's standard chart with approx. 700 characters (A4 or 8 1/2" x 11" long-edge feeding) at standard resolution in Super G3 mode, 33,600 bps, JBIG compression.

Document Filing (optional MX-EB16 required)

Document filing capacity*7	Main and custom folders: 20,000 pages or 3,000 files Quick file folder: 10,000 pages or 1,000 files
Stored jobs*8	Copy, print, scan, fax transmission
Storage folders	Quick file folder, main folder, custom folder (max. 1,000 folders)
Confidential storage	Password protection

Network Printer

Resolution	600 x 600 dpi; 9,600 (equivalent) x 600 dpi
Interface	USB 2.0, 10Base-T/100Base-TX/1000Base-T
Supported OS*9	Windows Server® 2003/2008/2012, Windows® XP, Windows Vista®, Windows® 7, Windows® 8, Mac OS X 10.4, 10.5, 10.6, 10.7, 10.8
Network protocols*9	TCP/IP (IPv4, IPv6), IPX/SPX (NetWare), EtherTalk (AppleTalk)
Printing protocols	LPR, Raw TCP (port 9100), POP3 (e-mail printing), HTTP, Novell Printserver application with NDS and Bindery, FTP for downloading print files, EtherTalk printing, IPP
PDL (emulation)	Standard: Sharp Advanced Printing Language-c, PCL 6 emulation*10 Option*11: PS3 emulation, XPS
Available fonts	80 fonts for PCL, 136 fonts for PS3 emulation

B/W Facsimile (optional MX-FX11 required)

Compression method	MH/MR/MMR/JBIG
Communication protocol	Super G3/G3
Transmission time	Less than 3 seconds*12
Modem speed	33,600 bps to 2,400 bps with automatic fallback
Transmission resolution	From Standard (203.2 x 97.8 dpi) to Ultra Fine (406.4 x 391 dpi)
Recording width	A3 to A5 (11" x 17" to 5 1/2" x 8 1/2")
Memory	512MB, max. 1GB*4
Grey scale levels	Equivalent to 256 levels

• Design and specifications are subject to change without prior notice.
 • Windows, Windows Server, and Windows Vista are registered trademarks of Microsoft Corporation in the United States and/or other countries. App Store is a service mark of Apple Inc. Apple, the Apple logo, iPhone, and iPad are trademarks of Apple Inc., registered in the US and other countries. IOS is a trademark or registered trademark of Cisco Systems, Inc. in the US and other countries and is used under license by Apple Inc. Android and Google Play are trademarks of Google Inc. All other brand names and product names may be trademarks or registered trademarks of their respective owners.
 • The ENERGY STAR logo is a certification mark and may only be used to certify products that have been determined to meet the ENERGY STAR programme requirements. ENERGY STAR is a US registered mark. The ENERGY STAR guidelines apply to products only in the US, the EU, Japan, Canada, Australia, New Zealand, and Taiwan.

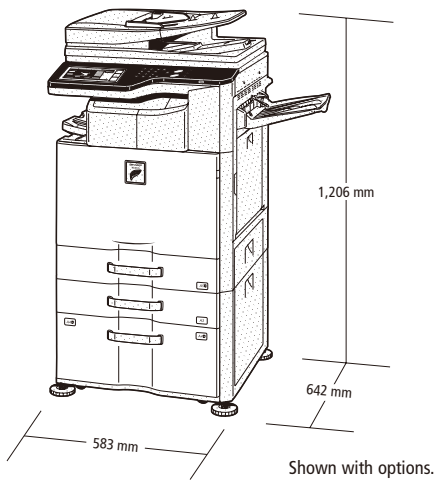

Distributed by:

