

Hypertherm®

2016 torch and consumables catalog

For mechanized plasma systems



Hypertherm Inc.

Etna Road, P.O. Box 5010

Hanover, NH 03755 USA

603-643-3441 Tel (Main Office)

603-643-5352 Fax (All Departments)

info@hypertherm.com (Main Office Email)

800-643-9878 Tel (Technical Service)

technical.service@hypertherm.com (Technical Service Email)

800-737-2978 Tel (Customer Service)

customer.service@hypertherm.com (Customer Service Email)

866-643-7711 Tel (Return Materials Authorization)

877-371-2876 Fax (Return Materials Authorization)

return.materials@hypertherm.com (RMA email)

Hypertherm Plasmatechnik GmbH

Technologiepark Hanau

Rodenbacher Chaussee 6

D-63457 Hanau-Wolfgang, Deutschland

49 6181 58 2100 Tel

49 6181 58 2134 Fax

49 6181 58 2123 (Technical Service)

Hypertherm (S) Pte Ltd.

82 Genting Lane

Media Centre

Annexe Block #A01-01

Singapore 349567, Republic of Singapore

65 6841 2489 Tel

65 6841 2490 Fax

65 6841 2489 (Technical Service)

Hypertherm (Shanghai) Trading Co., Ltd.

Unit 301, South Building

495 ShangZhong Road

Shanghai, 200231

PR China

86-21-60740003 Tel

86-21-60740393 Fax

Hypertherm Europe B.V.

Vaartveld 9

4704 SE

Roosendaal, Nederland

31 165 596907 Tel

31 165 596901 Fax

31 165 596908 Tel (Marketing)

31 165 596900 Tel (Technical Service)

00 800 4973 7843 Tel (Technical Service)

Hypertherm Japan Ltd.

Level 9, Edobori Center Building

2-1-1 Edobori, Nishi-ku

Osaka 550-0002 Japan

81 6 6225 1183 Tel

81 6 6225 1184 Fax

Hypertherm Brasil Ltda.

Rua Bras Cubas, 231 – Jardim Maia

Guarulhos, SP - Brasil

CEP 07115-030

55 11 2409 2636 Tel

55 11 2408 0462 Fax

Hypertherm México, S.A. de C.V.

Avenida Toluca No. 444, Anexo 1,

Colonia Olivar de los Padres

Delegación Álvaro Obregón

México, D.F. C.P. 01780

52 55 5681 8109 Tel

52 55 5683 2127 Fax

Hypertherm Korea Branch

#3904 Centum Leaders Mark B/D,

1514 Woo-dong, Haeundae-gu, Busan

Korea, 612-889

82 51 747 0358 Tel

82 51 701 0358 Fax

Contents

		Amperage	Upgrade technology	Page
Section 1	Technology benefits			iii
Section 2	Torches and consumables for current systems			
	HPR800XD®	30–800 A	SilverPlus®, HDi®	1
	HPR400XD®	30–400 A	SilverPlus®, HDi®	3
	HPR260XD®	30–260 A	SilverPlus®, HDi®	5
	HPR130XD®	30–130 A	SilverPlus®, HDi®	7
	HSD130®	45–130 A	SilverPlus®	9
	MAXPRO200®	50–200 A		11
	HyPro2000™ for the HT2000®	50–200 A	SilverPlus®	15
	HySpeed® HT2000®	40–200 A	SilverPlus®, HyPro2000™ torch	17
	HyPro2000™ for the MAX200®	50–200 A		19
	MAX200®	40–200 A	SilverPlus®, HyPro2000™ torch	21
Section 3	Torches and consumables for legacy systems			
	HPR260®	30–260 A	SilverPlus®, XD upgrade	25
	HPR130®	30–130 A	SilverPlus®, XD upgrade	27
	HPRHD4070®	30–200 A		30
	HD4070®	30–200 A		34
	HPRHD3070®	30–100 A		32
	HD3070®	15–100 A	HyPerformance® upgrade	36
	HT4400® HySpeed®	100–400 A	SilverPlus®	38
	HT4001®	260–760 A	SilverPlus®	40
	HT4000®	up to 400 A	SilverPlus®	42
	HT400®	up to 400 A	SilverPlus®	43
	PAC500™	up to 400 A		44



Hypertherm technology benefits

Hypertherm designs consumables for fast cutting speeds, long life, and superior cut quality for high productivity and low operating costs.

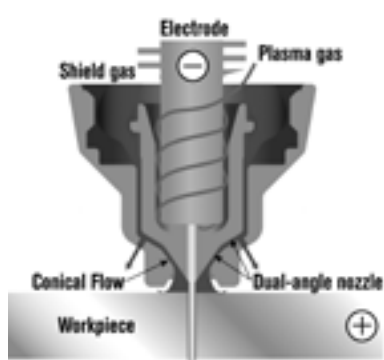

Conical Flow

Advanced axial swirl ring allows the long vented nozzle with exposed vent holes and swirl ring to align near the tip of the electrode, ensuring the correct amount of gas flow and optimal consumable life.

Chambered swirl ring gradually reduces gas pressure at the end of the cut to stabilize the hafnium insert prior to arc termination; this extends nozzle and electrode life.

Coaxial-assist™ jet increases cutting speed and cut quality by extending the tip of the nozzle into the exit of the shield.

Conical Flow™ nozzle technology increases arc energy density for superior cut quality with little dross.

CoolCore® allows for improved cooling of the electrode through effective removal of heat from the hafnium.

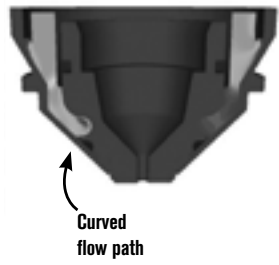

CoolFlow™

CoolFlow™ delivers enhanced cooling of the nozzle through key features such as a deep groove, angled o-ring seal and specific shoulder contact for increased nozzle life and cut quality.

Dimpled electrode extends electrode back life by preventing material from blowing on the nozzle when first ignited.

HDi® technology delivers **HyDefinition®** quality to thin stainless steel cutting from 3 mm (12 ga.) to 6 mm (1/4").

HyLife® extends electrode life and lowers operating costs.

HySpeed® technology utilizes Coaxial-assist jet technology to boost cutting speeds as much as 50% over conventional designs.

LongLife® ramps current and gas flow up and down in a tightly controlled manner to reduce electrode and nozzle erosion.

Note: Technologies vary by product. Refer to product pages for more details.

PowerPierce® liquid cooled shield technology repels molten metal during piercing. Enables robust production pierce capability up to 50 mm (2") mild steel and 75 mm (3") stainless steel and aluminum. Delivers speed and thickness capabilities.

300 pierces at 50 mm (2")



HPR400XD with PowerPierce technology

41 pierces at 45 mm (1¾")



Competitor A without PowerPierce technology

Quick-disconnect torch allows for ease of mounting and changing of the torch.

SilverPlus® silver front end tip which dramatically extends electrode life, reduces the number of change outs and significantly reduces operating cost.

Tool free allows consumables to be easily changed out.

TrueFlow™ allows for centered electrode alignment with the water tube to ensure optimal cooling, which increases life and produces a higher and consistent cut quality.

Vented shield™ is electrically isolated to prevent double arcing, the vent holes around the orifice stabilize the arc, cool the consumables, and protect them from spatter. These features improve piercing capabilities and increase consumable life.

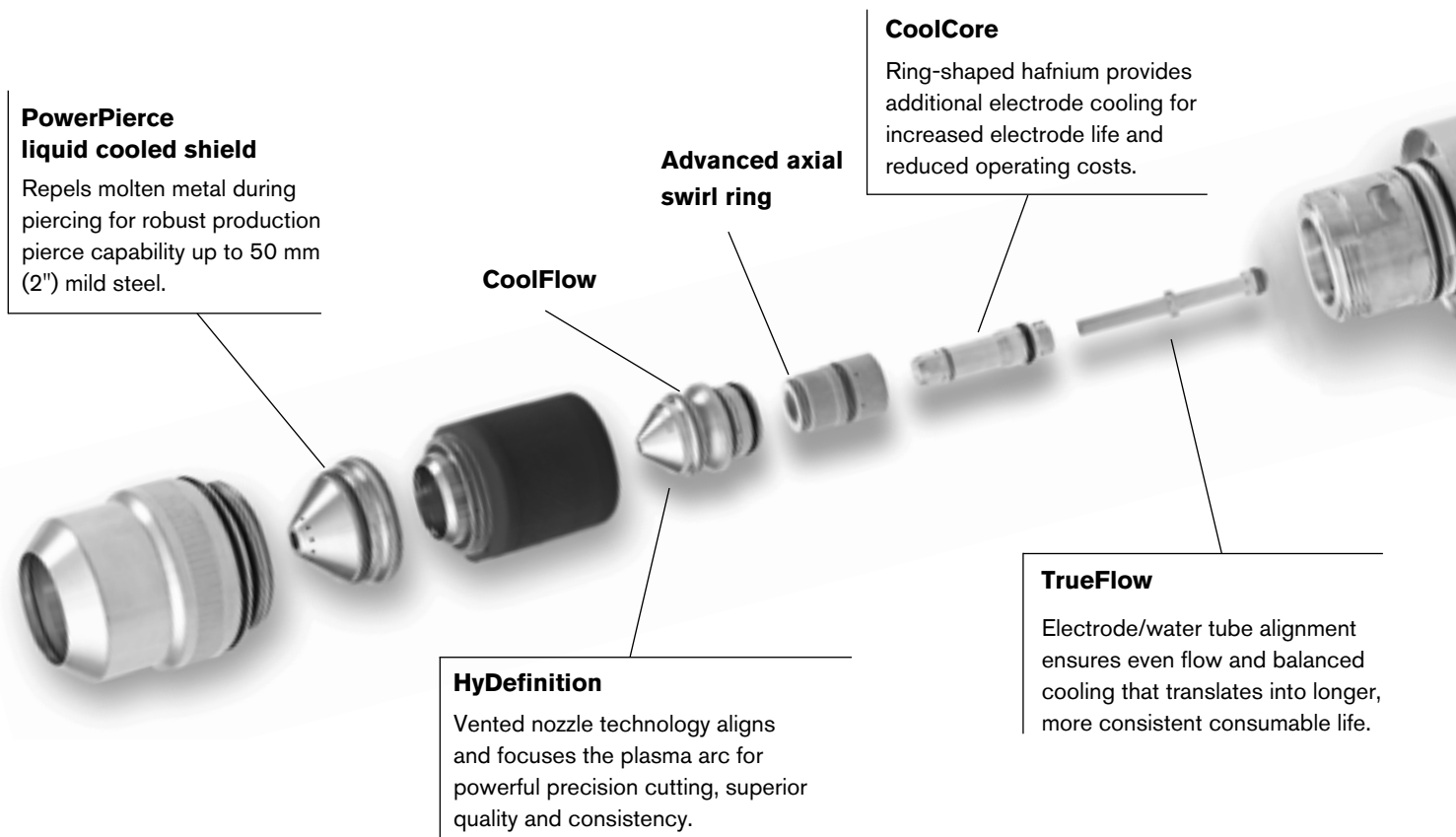

Value of preventive maintenance

You wouldn't expect your car to operate at peak efficiency if you never changed the oil or rotated the tires. And you shouldn't expect your Hypertherm plasma system to operate at peak efficiency without regular preventive maintenance.

Key advantages

Hypertherm Preventive Maintenance

Your Hypertherm plasma system is a precision machine with moving parts that require regular service. By performing regular preventive maintenance, you can extend the life of consumable parts, reduce down time, optimize performance and minimize operating costs.

Effective preventive maintenance involves an ongoing process of daily, weekly, monthly and annual checks. It's a simple fact that high stress or moving parts like torches, main contactors, relays and coolant require change-outs. Replace them on your schedule and get the most out of your mechanized system.

Plan for preventive maintenance in advance and experience the benefits

- Reduce downtime to lower the overall cost of cutting metal
- Extend consumable life, optimize performance through regular system "tune-ups"
- Ensure optimal operation; increase output and cut quality
- Cut unplanned repairs; execute scheduled maintenance on an "off shift"
- Eliminate costly labor for emergency repairs; keep things running smoothly
- Avoid expensive expedited shipping charges; buy parts on a schedule
- Rule out "added component" costs where simple failures lead to big problems

All the preventive maintenance tools you need are close at hand - reference the preventive maintenance kit table below, and order the kit that is right for your system today!

System kit	Part number
Legacy systems	
HT4001 [®]	228068
HT4400 [®]	228011
HD3070 [®]	228012
HPR130 [®]	228015
HPR260 [®]	228016
MAX200 [®]	228010
HT2000 [®]	128907

System kit	Part number
Current systems	
HSD130 [®]	228167
HPR130XD [®]	228605
HPR260XD [®] (200 to 240 V systems)	228606
HPR260XD [®] (380 to 600 V systems)	228623
HPR400XD [®] (200 to 240V systems)	228369
HPR400XD [®] (380 to 600 V systems)	228370
HPR800XD [®] (200-240 V systems)	228613
HPR800XD [®] (380 to 600 V systems)	228622

Hypertherm®

HyPerformance® Plasma HPR800XD®

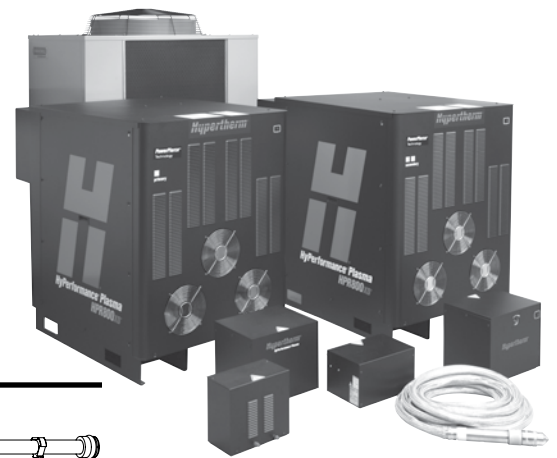

Consumables

Mild steel

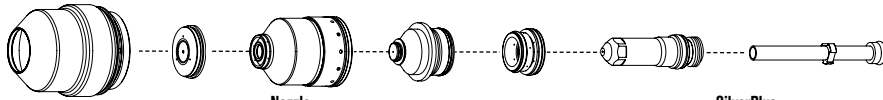

	Shield cap	Shield	Nozzle retaining cap	Nozzle	Swirl ring	Electrode	SilverPlus electrode	Water tube
30 A	220747	220194	220754	220193	220180	220192	—	220340
50 A	220747	220555	220754	220554	220553	220552	—	220340
80 A	220747	220189	220756	220188	220179	220187	—	220340
130 A	220747	220183	220756	220182	220179	220181	220665	220340
200 A	220637	220761	220757	220354	220353	220352	220666	220340
260 A	220637	220764	220760	220439	220436	220435	220668	220340
400 A	220637	220636	220635	220632	220631	220629	—	220571
80 A bevel	220637	220742	220845	220806	220179	220802	—	220700
130 A bevel	220637	220742	220740	220646	220179	220649	—	220700
200 A bevel	220637	220658	220845	220659	220353	220662	—	220700
260 A bevel	220637	220741	220740	220542	220436	220541	—	220571
*260 A bevel	220637	220897	220896	220898	220436	220899	—	220571
400 A bevel	220637	220636	220635	220632	220631	220629	—	220571

* Recommended for use if you have excessive slag, or the torch is misfiring, when using standard bevel consumables.

Stainless steel

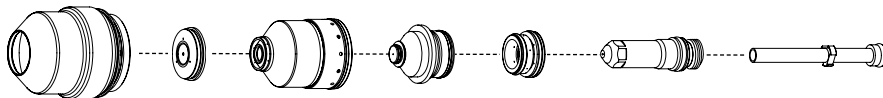

	Shield cap	Shield	Nozzle retaining cap	Nozzle	Swirl ring	Electrode	Water tube
45 A	220747	220202	220755	220201	220180	220308	220340
60 A HDi	220747	220815	220814	220847	220180	220339	220340
80 A	220747	220338	220755	220337	220179	220339	220340
130 A	220747	220198	220755 (H35)	220197	220179	220307	220340
			220756 (N ₂)				
200 A	220637	220762	220758	220343	220342	220307	220340
260 A	220637	220763	220758	220406	220405	220307	220340
400 A	220637	220707	220712	220708	220405	220709	220571
600 A	220637	220707	220635 (H35)	220859	220353 (H35)	220709	220571
			220885 (N ₂)		220405 (N ₂)		
100 mm (4") and below	220637	220886	220885	220884	220353	220882	220881
800 A above 100 mm (4")	220637	220886	220712	220884	220350	220882	220881
130 A bevel	220637	220738	220739	220656	220179	220606	220571
260 A bevel	220637	220738	220739	220607	220405	220606	220571
400 A bevel	220637	220707	220712	220708	220405	220709	220571
600 A bevel	220637	220707	220635 (H35)	220859	220353 (H35)	220709	220571
			220885 (N ₂)		220405 (N ₂)		
100 mm (4") and below	220637	220886	220885	220884	220353	220882	220881
800 A above 100 mm (4")	220637	220886	220712	220884	220350	220882	220881

Aluminum

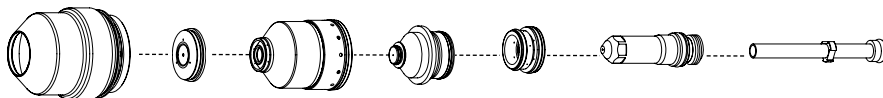

	Shield cap	Shield	Nozzle retaining cap	Nozzle	Swirl ring	Electrode	Water tube
45 A	220747	220202	220756	220201	220180	220308	220340
130 A	220747	220198	220755 (H35)	220197	220179	220307 (H35)	220340
			220756 (Air)			220181 (Air)	
200 A	220637	220762	220759	220346	220342	220307	220340
260 A	220637	220763	220758	220406	220405	220307	220340
400 A	220637	220707	220712	220708	220405	220709	220571
600 A	220637	220707	220712 (H35)	220859	220353 (H35)	220709	220571
			220885 (N ₂)		220405 (N ₂)		
100 mm (4") and below	220637	220886	220885	220884	220353	220882	220881
800 A above 100 mm (4")	220637	220886	220712	220884	220350	220882	220881



TECHNOLOGIES

- Advanced Axial Swirl Ring**
- Chambered Swirl Ring**
- Conical Flow™**
- CoolCore®**
- CoolFlow™**
- HyDefinition®**
- HyLife®**
- LongLife®**
- PowerPierce®**
- SilverPlus®**
- TrueFlow™**
- Vented Shield**
- HDi®**

HyPerformance® Plasma HPR800XD®

Torch assembly options

Standard leads

Lead length	Part number	
	6' gas	8' gas
2 m (6')	228291	228410
3 m (10')	228292	228411
4.5 m (15')	228293	228412
6 m (20')	228294	228413
7.5 m (25')	228295	228414
10 m (35')	228296	228415
15 m (50')	228297	228416

Robotic/Bevel leads

Lead length	Part number	
	6' gas	8' gas
2 m (6')	228514	228516
2.4 m (8')	228515	228517
3 m (10')	228475	228482
3.6 m (12')	228476	228483
4.5 m (15')	228477	228484
6 m (20')	228478	228485
7.5 m (25')	228479	228486
10 m (35')	228480	228487
15 m (50')	228481	228488

Torch mounting sleeves

Description	Length	Diameter	Part number
Standard	178 mm (7")	50.8 mm (2")	220789
Short	114 mm (4.5")	50.8 mm (2")	220788
Extended	248 mm (9.75")	50.8 mm (2")	220790
Rotational	146 mm (5.5")	50.8 mm (2")	220864

Quick-disconnect receptacle

220705

HyPerformance HPRXD torch main body

220706

Additional parts available (not shown)

Mild steel consumables starter kit (400 amps and below, mild steel)	228367
Aluminum/Stainless steel consumables starter kit (600/800 amps, aluminum/stainless steel)	228603
Aluminum/Stainless steel consumables starter kit (400 amps and below, aluminum/stainless steel)	228368
Torch kit, o-rings, water tube	128879
Quick-disconnect kit, o-ring and connector	128880
Consumables removal tool	104119
Silicon lubricant for o-rings	027055
Preventive maintenance kit (200 – 240 V)	228613
Preventive maintenance kit (380 – 600 V)	228622

Additional torches available

Part number	130 A	260 A	400 A	800 A	Standard Consumables	Bevel Consumables	Standard Sleeve	Short Sleeve	Extended Sleeve	Robotic Sleeve
228520	■					■	■			
228633	■				■			■		
228989	■					■		■		
228551	■					■		■		
228990	■					■			■	
428311		■				■				■
228521		■				■	■			
228634		■			■			■		
228991		■				■		■		
228992		■				■			■	
428312		■				■				■
228354			■		■	■	■			
228987			■		■	■		■		
228988			■		■	■			■	
428313			■		■	■				■
228599				■	■	■	■			

Hypertherm, HyPerformance, HPR, Advanced axial swirl ring, Chambered swirl ring, Conical Flow, CoolCore, CoolFlow, HyDefinition, HyLife, LongLife, PowerPierce, SilverPlus, TrueFlow, Vented shield and HD are trademarks of Hypertherm, Inc. and may be registered in the United States and/or other countries



Torch leads



Torch mounting sleeve



Quick-disconnect receptacle



HyPerformance HPRXD torch main body

Section 2: Current systems

Hypertherm®

HyPerformance® Plasma HPR400xd®

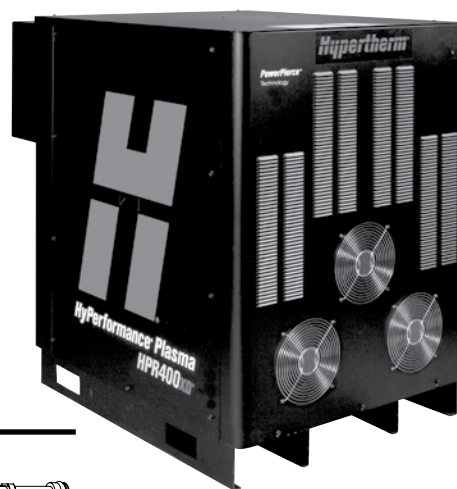

Consumables

Mild steel

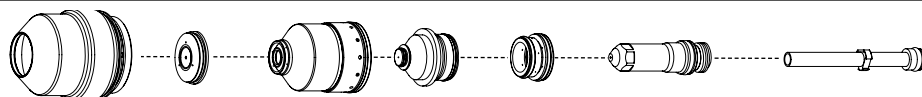

	Shield cap	Shield	Nozzle retaining cap	Nozzle	Swirl ring	Electrode	SilverPlus electrode	Water tube
30 A	220747	220194	220754	220193	220180	220192	—————	220340
50 A	220747	220555	220754	220554	220553	220552	—————	220340
80 A	220747	220189	220756	220188	220179	220187	—————	220340
130 A	220747	220183	220756	220182	220179	220181	220665	220340
200 A	220637	220761	220757	220354	220353	220352	220666	220340
260 A	220637	220764	220760	220439	220436	220435	220668	220340
400 A	220637	220636	220635	220632	220631	220629	—————	220571
80 A bevel	220637	220742	220845	220806	220179	220802	—————	220700
130 A bevel	220637	220742	220740	220646	220179	220649	—————	220700
200 A bevel	220637	220658	220845	220659	220353	220662	—————	220700
260 A bevel	220637	220741	220740	220542	220436	220541	—————	220571
*260 A bevel	220637	220897	220896	220898	220436	220899	—————	220571
400 A bevel	220637	220636	220635	220632	220631	220629	—————	220571

* Recommended for use if you have a problem with excessive slag, or problems with the torch misfiring, when using standard bevel consumables.

Stainless steel

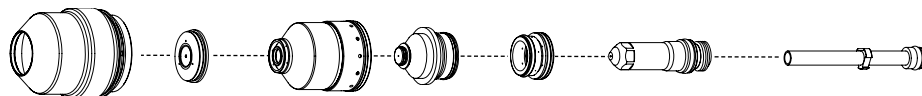

	Shield cap	Shield	Nozzle retaining cap	Nozzle	Swirl ring	Electrode	Water tube
45 A	220747	220202	220755	220201	220180	220308	220340
60 A HDi	220747	220815	220814	220847	220180	220339	220340
80 A	220747	220338	220755	220337	220179	220339	220340
130 A	220747	220198	220755 (H35) 220756 (N ₂)	220197	220179	220307	220340
200 A	220637	220762	220758	220343	220342	220307	220340
260 A	220637	220763	220758	220406	220405	220307	220340
400 A	220637	220707	220712	220708	220405	220709	220571
130 A bevel	220637	220738	220739	220656	220179	220606	220571
260 A bevel	220637	220738	220739	220607	220405	220606	220571
400 A bevel	220637	220707	220712	220708	220405	220709	220571

Aluminum

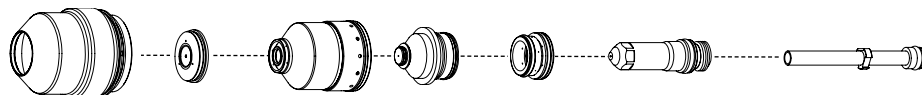

	Shield cap	Shield	Nozzle retaining cap	Nozzle	Swirl ring	Electrode	Water tube
45 A	220747	220202	220756	220201	220180	220308	220340
130 A	220747	220198	220755 (H35) 220756 (Air)	220197	220179	220307 (H35) 220181 (Air)	220340
200 A	220637	220762	220759	220346	220342	220307	220340
260 A	220637	220763	220758	220406	220405	220307	220340
400 A	220637	220707	220712	220708	220405	220709	220571



TECHNOLOGIES

Advanced Axial Swirl Ring
Chambered Swirl Ring
Conical Flow™
CoolCore®
CoolFlow™
HyDefinition®
HyLife®
LongLife®
PowerPierce®
SilverPlus®
TrueFlow™
Vented Shield
HDi®

HyPerformance[®] Plasma HPR400XD[®]

Torch assembly options

Standard leads

Lead length	Part number	
	6' gas	8' gas
2 m (6')	228291	228410
3 m (10')	228292	228411
4.5 m (15')	228293	228412
6 m (20')	228294	228413
7.5 m (25')	228295	228414
10 m (35')	228296	228415
15 m (50')	228297	228416
20 m (65')	228547	228516

Robotic/Bevel leads

Lead length	Part number	
	6' gas	8' gas
2 m (6')	228514	228516
2.4 m (8')	228515	228517
3 m (10')	228475	228482
3.6 m (12')	228476	228483
4.5 m (15')	228477	228484
6 m (20')	228478	228485
7.5 m (25')	228479	228486
10 m (35')	228480	228487
15 m (50')	228481	228488

Mounting sleeves

Description	Length	Diameter	Part number
Standard	181 mm (7")	50.8 mm (2")	220789
Short	114 mm (4.5")	50.8 mm (2")	220788
Extended	248 mm (9.75")	50.8 mm (2")	220790
Rotational	146 mm (5.5")	50.8 mm (2")	220864

Quick-disconnect receptacle

220705

HyPerformance HPRXD torch

220706

Additional parts available (not shown)

Mild steel consumables starter kit	(All amps, mild steel)	228367
Aluminum/Stainless steel consumables starter kit	(All amps, aluminum/stainless steel)	228368
Torch kit, o-rings, water tube		128879
Quick-disconnect kit, o-ring and connector		128880
Consumables removal tool		104119
Silicon lubricant for o-rings		027055
Preventive maintenance kit (200 – 240 V)		228369
Preventive maintenance kit (380 – 600 V)		228370

Additional torches available

Part number	130 A	260 A	400 A	Standard Consumables	Bevel Consumables	Standard Sleeve	Short Sleeve	Extended Sleeve	Robotic Sleeve
228520	■				■	■			
228633	■			■			■		
228989	■				■		■		
228551	■				■		■		
228990	■				■			■	
428311		■			■				■
228521		■			■	■			
228634		■		■			■		
228991		■			■		■		
228992		■			■			■	
428312		■			■				■
228354			■	■	■	■			
228987			■	■	■		■		
228988			■	■	■			■	
428313			■	■	■				■



Leads



Mounting sleeve



Quick-disconnect receptacle



HyPerformance HPRXD torch

Hypertherm, HyPerformance, HPR, Advanced axial swirl ring, Chambered swirl ring, Conical Flow, CoolCore, CoolFlow, HyDefinition, HyLife, LongLife, PowerPierce, SilverPlus, TrueFlow, Vented shield and HD are trademarks of Hypertherm, Inc. and may be registered in the United States and/or other countries

Hypertherm®

HyPerformance® Plasma HPR260XD®



Consumables

Mild steel

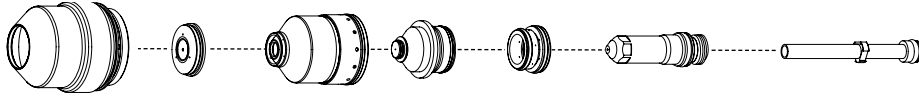

	Shield cap	Shield	Nozzle retaining cap	Nozzle	Swirl ring	Electrode	SilverPlus electrode	Water tube
30 A	220747	220194	220754	220193	220180	220192	—————	220340
50 A	220747	220555	220754	220554	220553	220552	—————	220340
80 A	220747	220189	220756	220188	220179	220187	—————	220340
130 A	220747	220183	220756	220182	220179	220181	220665	220340
200 A	220637	220761	220757	220354	220353	220352	220666	220340
260 A	220637	220764	220760	220439	220436	220435	220668	220340
80 A bevel	220637	220742	220845	220806	220179	220802	—————	220700
130 A bevel	220637	220742	220740	220646	220179	220649	—————	220700
200 A bevel	220637	220658	220845	220659	220353	220662	—————	220700
260 A bevel	220637	220741	220740	220542	220436	220541	—————	220571
*260 A bevel	220637	220897	220896	220898	220436	220899	—————	220571

* Recommended for use if you have a problem with excessive slag, or problems with the torch misfiring, when using standard bevel consumables.

Stainless steel

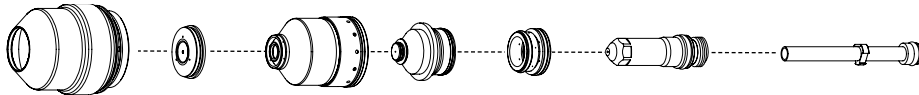

	Shield cap	Shield	Nozzle retaining cap	Nozzle	Swirl ring	Electrode	Water tube
45 A	220747	220202	220755	220201	220180	220308	220340
60 A HDi	220747	220815	220814	220847	220180	220339	220340
80 A	220747	220338	220755	220337	220179	220339	220340
130 A	220747	220198	220755 (H35) 220756 (N ₂)	220197	220179	220307	220340
200 A	220637	220762	220758	220343	220342	220307	220340
260 A	220637	220763	220758	220406	220405	220307	220340
130 A bevel	220637	220738	220739	220656	220179	220606	220571
260 A bevel	220637	220738	220739	220607	220405	220606	220571

Aluminum

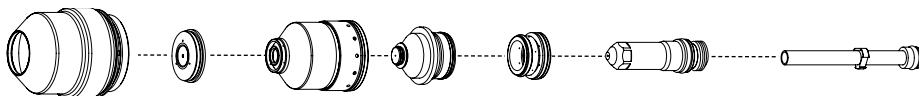

	Shield cap	Shield	Nozzle retaining cap	Nozzle	Swirl ring	Electrode	Water tube
45 A	220747	220202	220756	220201	220180	220308	220340
130 A	220747	220198	220755 (H35) 220756 (Air)	220197	220179	220307 (H35) 220181 (Air)	220340
200 A	220637	220762	220759	220346	220342	220307	220340
260 A	220637	220763	220758	220406	220405	220307	220340



TECHNOLOGIES

Chambered Swirl Ring
Conical Flow™
CoolCore®
CoolFlow™
HyDefinition®
HyLife®
LongLife®
PowerPierce®
SilverPlus®
TrueFlow™
Vented Shield
HDi®

HyPerformance[®] Plasma HPR260XD[®]

Torch assembly options

Standard leads

Lead length	Part number	
	6' gas	8' gas
2 m (6')	228291	228410
3 m (10')	228292	228411
4.5 m (15')	228293	228412
6 m (20')	228294	228413
7.5 m (25')	228295	228414
10 m (35')	228296	228415
15 m (50')	228297	228416
20 m (65')	228547	228516

Robotic/Bevel leads

Lead length	Part number	
	6' gas	8' gas
2 m (6')	228514	228516
2.4 m (8')	228515	228517
3 m (10')	228475	228482
3.6 m (12')	228476	228483
4.5 m (15')	228477	228484
6 m (20')	228478	228485
7.5 m (25')	228479	228486
10 m (35')	228480	228487
15 m (50')	228481	228488

Mounting sleeves

Description	Length	Diameter	Part number
Standard	181 mm (7")	50.8 mm (2")	220789
Short	114 mm (4.5")	50.8 mm (2")	220788
Extended	248 mm (9.75")	50.8 mm (2")	220790
Rotational	146 mm (5.5")	50.8 mm (2")	220864

Quick-disconnect receptacle

220705

HyPerformance HPRXD torch

220706

Additional parts available (not shown)

Mild steel consumables starter kit	(All amps, mild steel)	228422
Aluminum/Stainless steel consumables starter kit	(All amps, aluminum/stainless steel)	228423
Torch kit, o-rings, water tube		128879
Quick-disconnect kit, o-ring and connector		128880
Consumables removal tool		104119
Silicon lubricant for o-rings		027055
Preventive maintenance kit (200 – 240 V)		228606
Preventive maintenance kit (380 – 600 V)		228623

Additional torches available

Part number	130 A	260 A	Standard Consumables	Bevel Consumables	Standard Sleeve	Short Sleeve	Extended Sleeve	Robotic Sleeve
228520	■			■	■			
228633	■		■			■		
228989	■			■		■		
228551	■			■		■		
228990	■			■			■	
428311		■		■				■
228521		■		■	■			
228634		■	■			■		
228991		■		■		■		
228992		■		■			■	
428312		■		■				■



Leads



Mounting sleeve



Quick-disconnect receptacle



HyPerformance HPRXD torch

Hypertherm, HyPerformance, HPR, Advanced axial swirl ring, Chambered swirl ring, Conical Flow, CoolCore, CoolFlow, HyDefinition, HyLife, LongLife, PowerPierce, SilverPlus, TrueFlow, Vented shield and HD are trademarks of Hypertherm, Inc. and may be registered in the United States and/or other countries

Hypertherm®

HyPerformance® Plasma HPR130XD®



Consumables

Mild steel

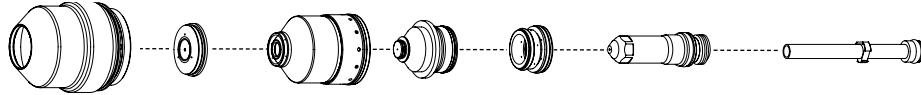

	Shield cap	Shield	Nozzle retaining cap	Nozzle	Swirl ring	Electrode	SilverPlus electrode	Water tube
30 A	220747	220194	220754	220193	220180	220192	—————	220340
50 A	220747	220555	220754	220554	220553	220552	—————	220340
80 A	220747	220189	220756	220188	220179	220187	—————	220340
130 A	220747	220183	220756	220182	220179	220181	220665	220340
80 A bevel	220637	220742	220845	220806	220179	220802	—————	220700
130 A bevel	220637	220742	220740	220646	220179	220649	—————	220700

Stainless steel

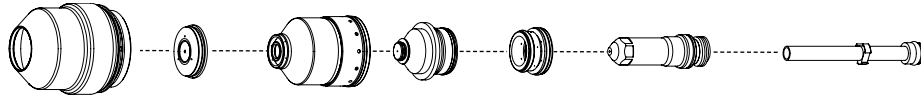

	Shield cap	Shield	Nozzle retaining cap	Nozzle	Swirl ring	Electrode	Water tube
45 A	220747	220202	220755	220201	220180	220308	220340
60 A HDi	220747	220815	220814	220847	220180	220339	220340
80 A	220747	220338	220755	220337	220179	220339	220340
130 A	220747	220198	220755 (H35) 220756 (N ₂)	220197	220179	220307	220340
130 A bevel	220637	220738	220739	220656	220179	220606	220571

Aluminum

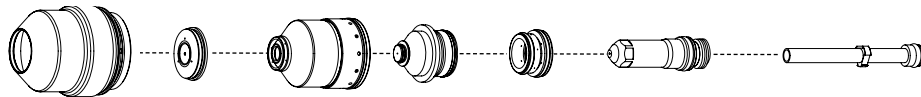

	Shield cap	Shield	Nozzle retaining cap	Nozzle	Swirl ring	Electrode	Water tube
45 A	220747	220202	220756	220201	220180	220308	220340
130 A	220747	220198	220755 (H35) 220756 (Air)	220197	220179	220307 (H35) 220181 (Air)	220340

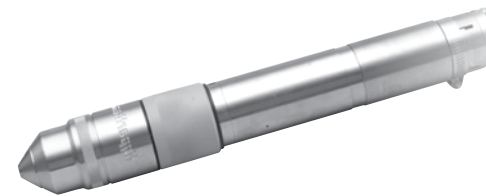

TECHNOLOGIES

Chambered Swirl Ring
Conical Flow™
CoolCore®
CoolFlow™
HyDefinition®
HyLife®
LongLife®
PowerPierce®
SilverPlus®
TrueFlow™
Vented Shield
HDi®

HyPerformance[®] Plasma HPR130XD[®]

Torch assembly options

Standard leads

Lead length	Part number	
	6' gas	8' gas
2 m (6')	228291	228410
3 m (10')	228292	228411
4.5 m (15')	228293	228412
6 m (20')	228294	228413
7.5 m (25')	228295	228414
10 m (35')	228296	228415
15 m (50')	228297	228416
20 m (65')	228547	228516

Robotic/Bevel leads

Lead length	Part number	
	6' gas	8' gas
2 m (6')	228514	228516
2.4 m (8')	228515	228517
3 m (10')	228475	228482
3.6 m (12')	228476	228483
4.5 m (15')	228477	228484
6 m (20')	228478	228485
7.5 m (25')	228479	228486
10 m (35')	228480	228487
15 m (50')	228481	228488

Mounting sleeves

Description	Length	Diameter	Part number
Standard	181 mm (7")	50.8 mm (2")	220789
Short	114 mm (4.5")	50.8 mm (2")	220788
Extended	248 mm (9.75")	50.8 mm (2")	220790
Rotational	146 mm (5.5")	50.8 mm (2")	220864

Quick-disconnect receptacle

220705

HyPerformance HPRXD torch

220706

Additional parts available (not shown)

Mild steel consumables starter kit	(All amps, mild steel)	228420
Aluminum/Stainless steel consumables starter kit	(All amps, aluminum/stainless steel)	228421
Torch kit, o-rings, water tube		128879
Quick-disconnect kit, o-ring and connector		128880
Consumables removal tool		104119
Silicon lubricant for o-rings		027055
Preventive maintenance kit		228605

Additional torches available

Part number	130 A	Standard Consumables	Bevel Consumables	Standard Sleeve	Short Sleeve	Extended Sleeve	Robotic Sleeve
228520	■		■	■			
228633	■	■			■		
228989	■		■		■		
228551	■		■		■		
428312	■		■			■	



Leads



Mounting sleeve



Quick-disconnect receptacle



HyPerformance HPRXD torch

Hypertherm, HyPerformance, HPR, Advanced axial swirl ring, Chambered swirl ring, Conical Flow, CoolCore, CoolFlow, HyDefinition, HyLife, LongLife, PowerPierce, SilverPlus, TrueFlow, Vented shield and HD are trademarks of Hypertherm, Inc. and may be registered in the United States and/or other countries

Hypertherm®

HySpeed® Plasma HSD130®



Consumables

O₂ – Mild steel



	Shield	Retaining cap	Nozzle	Swirl ring	Electrode	SilverPlus electrode	Water tube
50 A	220532	220578	220530	220529	220528		220521
130 A	220491	220578	220489	220488	220487	420185	220521

Air – Mild steel/Stainless steel/Aluminum

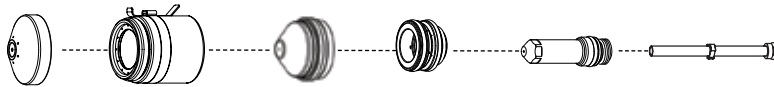

	Shield	Retaining cap	Nozzle	Swirl ring	Electrode	Water tube
45 A	220532	220578	220525	220529	220528	220521
130 A	220536	220578	220492	220488	220487	220521

N₂ – Stainless steel

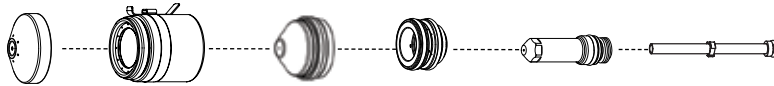

	Shield	Retaining cap	Nozzle	Swirl ring	Electrode	Water tube
45 A	220532	220534	220525	220529	220528	220521
130 A	220536	220578	220535	220488	020415	220521

H35 – Stainless steel/Aluminum

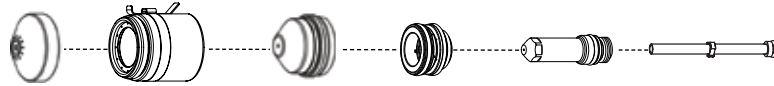

	Shield	Retaining cap	Nozzle	Swirl ring	Electrode	Water tube
130 A	220536	220534	220535	220529	020415	220521



Section 2: Current systems

TECHNOLOGIES

Chambered swirl ring™
HyLife®
HySpeed™
Tool free
TrueFlow™

HySpeed® Plasma HSD130®

Torch assembly options

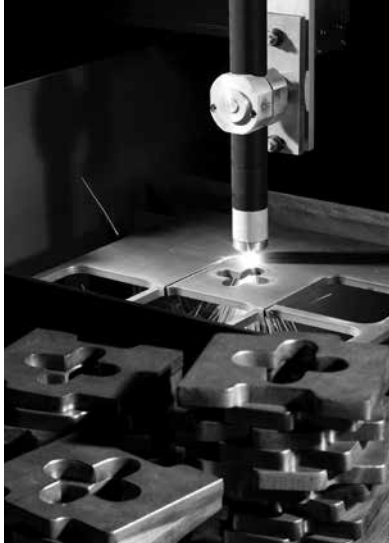

Standard leads

Lead length	Part number
7.5 m (25')	228050
15 m (50')	228051

Mounting sleeves

Description	Length	Diameter	Part number
Standard	228 mm (9")	44.45 mm (1.75")	220473

Torch

Description	Part number
Standard	220474

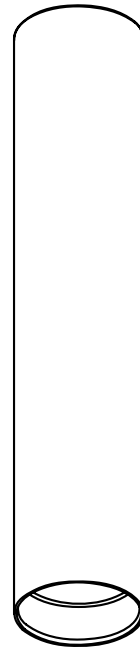

Mounting sleeve

Additional parts available (not shown)

Description	Part number
HSD machine torch assembly (torch, sleeve, 130 A O ₂ consumables)	228144
Consumables starter kit (mild steel)	228146
Consumables starter kit (stainless steel, aluminum)	228156
Preventive maintenance kit (contactor, filters, coolant, torch)	228167
Silicon lubricant for o-rings	027055
Electrode pit depth gauge	004630
Electrode removal tool	027102

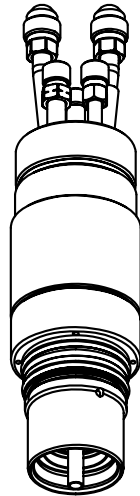

HSD130
torch

Hypertherm®

MAXPRO200®



MAXPRO200 machine torch consumables

Air – Mild steel/Stainless steel/Aluminum

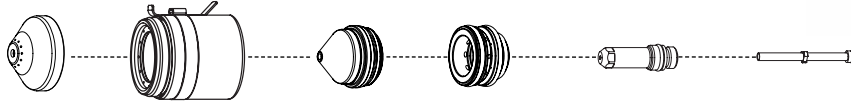

	Shield	Shield cap	Nozzle	Swirl ring	Electrode	Water tube
50 A	220532	220936 220935 without tab	220890	220529	220528	220521
130 A	220536	220936 220935 without tab	220892	220488	220487	220521
200 A	420045	220936 220935 without tab	420044	220488	220937	220521

O₂ – Mild steel

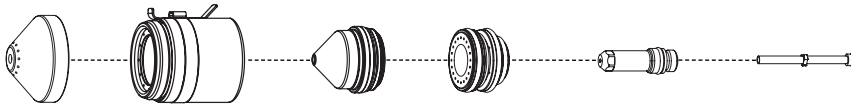

	Shield	Shield cap	Nozzle	Swirl ring	Electrode	Water tube
50 A	220532	220936 220935 without tab	220891	220529	220528	220521
130 A	220491	220936 220935 without tab	220893	220488	220487	220521
200 A	220832	220936 220935 without tab	220831	220834	220937	220521

N₂ – Stainless steel/Aluminum

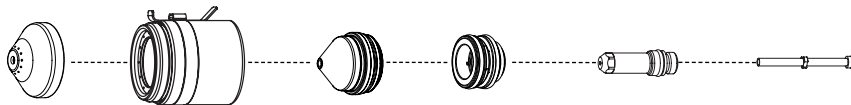

	Shield	Shield cap	Nozzle	Swirl ring	Electrode	Water tube
130 A	220536	220936 220935 without tab	220892	220529	020415	220521
200 A	420045	220936 220935 without tab	420044	220529	020415	220521



MAXPRO200 quick-disconnect machine torch



MAXPRO200 straight machine torch

TECHNOLOGIES

- Chambered Swirl Ring**
- Conical Flow™**
- CoolFlow™**
- LongLife®**
- TrueFlow™**
- Vented Shield**
- HyLife®**
- Tool free lead connection**
- Tool free nozzle**
- Inline valve process**

MAXPRO200[®]

Machine torch assembly options

Standard leads

Lead length	Part number
7.5 m (25')	229477
15 m (50')	229478
23 m (75')	229479
30 m (100')	229480

Mounting sleeves

Description	Length	Diameter	Part number
Standard	279.4 mm (11")	50.8 mm (2")	220943
Standard	279.4 mm (11")	44.45 mm (1.75")	220942

Torch options

Description	Part number
Straight torch (standard)	420087
Quick-disconnect receptacle (option)	420033

HyPro2000 Quick-disconnect torch (option) 220921

Additional parts available (not shown)

Machine torch (straight torch, set of 200 A consumables)	228937
Consumables removal tool	104119
Machine torch consumables starter kit	428013
Silicon lubricant for o-rings	027055

Mounting sleeve
(2" outside
diameter)

Mounting sleeve
(1.75" outside
diameter)

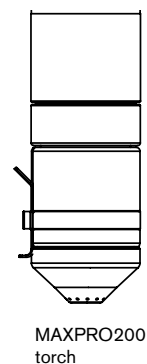
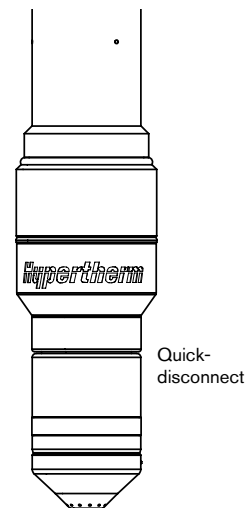
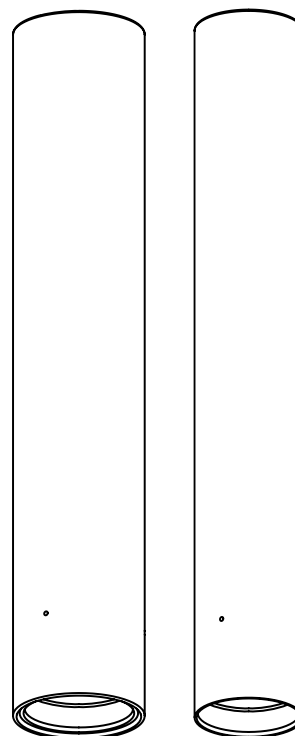

Hypertherm®

MAXPRO200®



MAXPRO200 hand torch consumables

Air-mild steel/Stainless steel/Aluminum

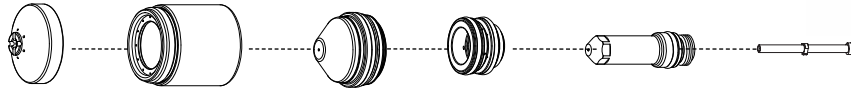

	Shield	Shield cap	Nozzle	Swirl ring	Electrode	Water tube
50 A	420063	220935	220890	220529	220528	220521
130 A	420061	220935	220892	220488	220487	220521
200 A	420058	220935	420044	220488	220937	220521
200 A gouging	420067	220935	420066	220488	220937	220521

O₂ – mild steel

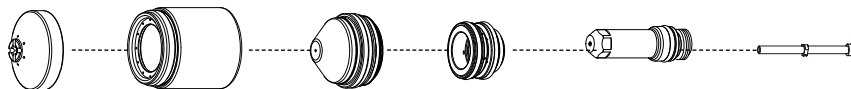

	Shield	Shield cap	Nozzle	Swirl ring	Electrode	Water tube
50 A	420063	220935	220891	220529	220528	220521
130 A	420062	220935	220893	220488	220487	220521
200 A	420059	220935	220831	220834	220937	220521



MAXPRO200 65° hand torch



MAXPRO200 90° hand torch

TECHNOLOGIES

- Chambered Swirl Ring**
- Conical Flow™**
- CoolFlow™**
- LongLife®**
- TrueFlow™**
- Vented Shield**
- HyLife®**
- Tool free lead connection**
- Tool free nozzle**
- Inline valve process**

MAXPRO200[®]

Hand torch assembly options

Standard leads

Lead length	Part number
7.5 m (25')	428131
15 m (50')	428132
23 m (75')	428133
30 m (100')	428134

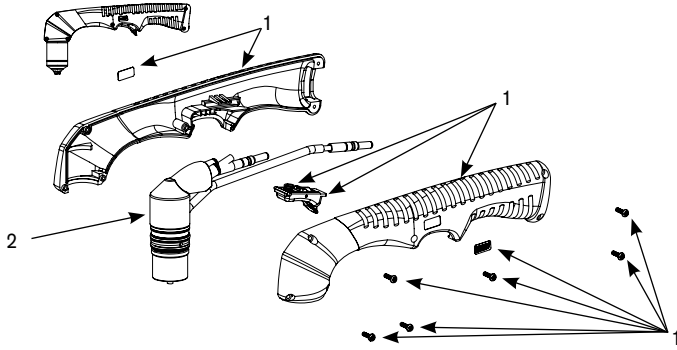

90 degree hand torch options

	Description	Part number
1	Handle replacement kit	228985
2	Torch main body	428109
	Handheld consumables starter kit	428014

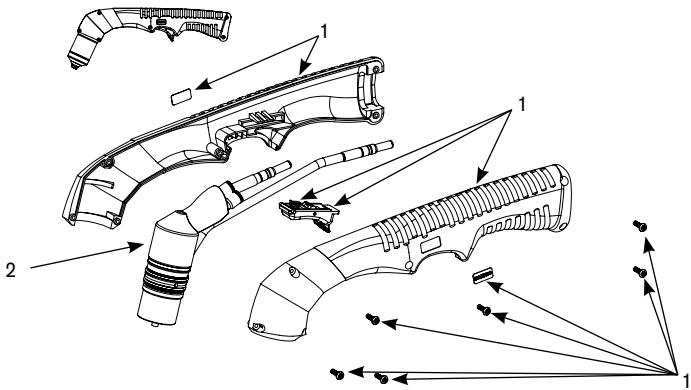

65 degree hand torch options

	Description	Part number
1	Handle replacement kit	228986
2	Torch main body	428108
	Handheld consumables starter kit	428014

Hypertherm®

HyPro2000™ upgrade torch

For HT2000



Consumables

O₂ – Mild steel

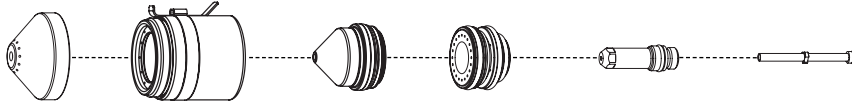

	Shield	Shield cap	Nozzle	Swirl ring	Electrode	SilverPlus electrode	Water tube
50 A	220532	220936	220891	220529	220528	-----	220521
		220935 without tab				-----	
130 A	220491	220936	220893	220488	220487	420185	220521
		220935 without tab				-----	
200 A	220832	220936	220831	220834	220937	220925	220521
		220935 without tab				-----	

Air – Mild steel/Stainless steel/Aluminum

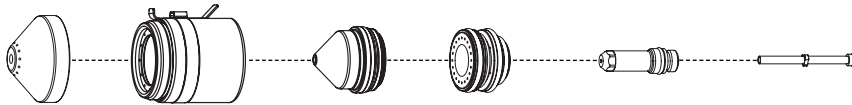

	Shield	Shield cap	Nozzle	Swirl ring	Electrode	Water tube
50 A	220532	220936	220890	220529	220528	220521
		220935 without tab				
130 A	220536	220936	220892	220488	220487	220521
		220935 without tab				
200 A	420045	220936	420044	220488	220937	220521
		220935 without tab				

N₂ – Stainless steel/Aluminum

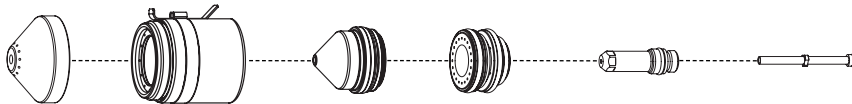

	Shield	Shield cap	Nozzle	Swirl ring	Electrode	Water tube
200 A	420045	220936	420044	220529	020415	220521
		220935 without tab				



HyPro2000 straight torch



HyPro2000 quick-disconnect torch

TECHNOLOGIES

- Chambered swirl ring™**
- Conical Flow™**
- CoolFlow™**
- LongLife®**
- SilverPlus®**
- TrueFlow™**
- Vented shield**
- HyLife®**

HyPro2000™

Torch assembly options

Standard leads – RHF

Lead length	Part number
3 m (10')	028657
4.6 m (15')	028658
6.1 m (20')	028659
7.6 m (25')	028546
9.2 m (30')	028660
10.6 m (35')	028661
12.2 m (40')	028662
13.7 m (45')	028663
15.3 m (50')	028547
16.8 m (55')	028767
18.3 m (60')	028768

Standard leads – LHF

Lead length	Part number
3 m (10')	028657
4.6 m (15')	028658
6.1 m (20')	028659
7.6 m (25')	028546
9.2 m (30')	028660
10.6 m (35')	028661
12.2 m (40')	028662
13.7 m (45')	028663

Mounting sleeves

Description	Length	Diameter	Part number
Standard	279.4 mm (11")	50.8 mm (2")	220943
Standard	279.4 mm (11")	44.45 mm (1.75")	220942

Quick-disconnect receptacle

220913

HyPro2000 Quick-disconnect torch

220921

Torch upgrade kits – HyPro2000 (Systems prior to 2003)

228549

RHF serial number 2000-06450 and below
LHF serial number 2lhf2000-000580 and below.

Includes: control board, machine torch (loaded with consumables), quick-disconnect receptacle, mounting sleeves (2" and 1.75"), 200 A O₂ shield, 200 A O₂ shield cap, 200 A O₂ nozzles, 200 A O₂ swirl ring, 200 A O₂ SilverPlus electrodes, 200 A O₂ copper electrodes, silicon lubricant for o-rings, consumable removal tool, chip removal tool, chip upgrade, pressure gage, plastic tube for hoses, hose (24"), operating manual.

Torch upgrade kits – HyPro2000 (2003 – current systems)

228550

RHF serial number 2000-06451 and above
LHF serial number 2lhf2000-000581 and above.

Includes: machine torch (loaded with consumables), quick-disconnect receptacle, mounting sleeves (2" and 1.75"), 200 A O₂ shield, 200 A O₂ shield cap, 200 A O₂ nozzles, 200 A O₂ swirl ring, 200 A O₂ SilverPlus electrodes, 200 A O₂ copper electrodes, silicon lubricant for o-rings, consumable removal tool, chip removal tool, chip upgrade, pressure gage, plastic tube for hoses, hose (24"), operating manual.

HyPro2000 for punch presses

220961

Torch upgrade kits – HyPro2000 (Systems prior to 2003)

228778

RHF serial number 2000-06450 and below
LHF serial number 2lhf2000-000580 and below.

Includes: control board, straight torch for punch presses, mounting sleeves (2" and 1.75"), 200 A O₂ shield, 200 A O₂ shield cap, 200 A O₂ nozzles, 200 A O₂ swirl ring, 200 A O₂ SilverPlus electrodes, 200 A O₂ copper electrodes, silicon lubricant for o-rings, consumable removal tool, chip removal tool, chip upgrade, pressure gage, plastic tube for hoses, hose (24"), operating manual.

Torch upgrade kits – HyPro2000 (2003 – current systems)

228777

RHF serial number 2000-06451 and above
LHF serial number 2lhf2000-000581 and above.

Includes: straight torch for punch presses, mounting sleeves (2" and 1.75"), 200 A O₂ shield, 200 A O₂ shield cap, 200 A O₂ nozzles, 200 A O₂ swirl ring, 200 A O₂ SilverPlus electrodes, 200 A O₂ copper electrodes, silicon lubricant for o-rings, consumable removal tool, chip removal tool, chip upgrade, pressure gage, plastic tube for hoses, hose (24"), operating manual.

Additional parts available (not shown)

Machine torch (Quick-disconnect torch, set of 200 A consumables)	228557
Chip upgrade (includes 2 chips)	228571
Chip removal tool	027338
Consumables removal tool	104119
Silicon lubricant for o-rings	027055
Consumables kit – O ₂ , 50 A	228772
Consumables kit – Air, 50 A	228773
Consumables kit – O ₂ , 130 A	228770
Consumables kit – Air, 130 A	228771
*HT2000 off-valve assembly – LHF	129840

*129840 is required on LHF systems, if not already installed.

 Selected consumables are no longer available.
Contact Hypertherm for recommended alternative products

Hypertherm, HyPerformance, HPR, Advanced axial swirl ring, Chambered swirl ring, Conical Flow, CoolCore, CoolFlow, HyDefinition, HyLife, LongLife, PowerPierce, SilverPlus, TrueFlow, Vented shield and HD are trademarks of Hypertherm, Inc. and may be registered in the United States and/or other countries

Mounting sleeve
(2" outside
diameter)

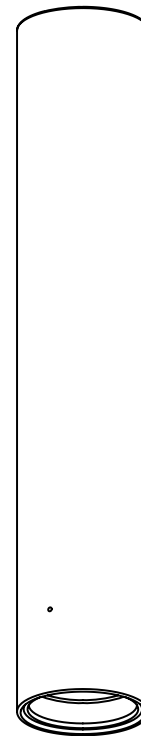

Mounting sleeve
(1.75" outside
diameter)

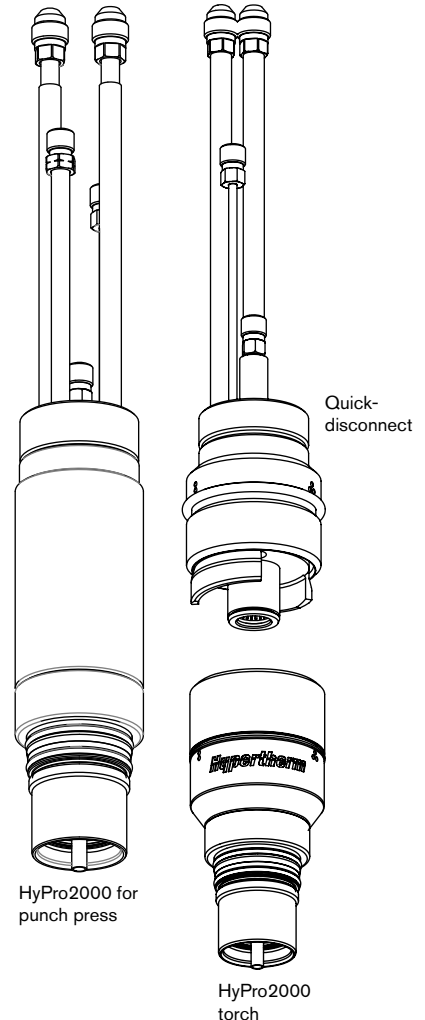
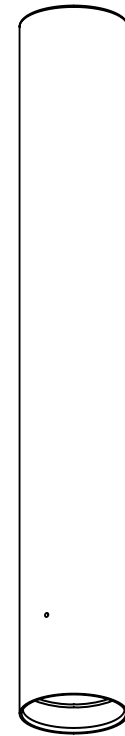

Hypertherm®

HySpeed® HT2000®



Consumables

Mild steel

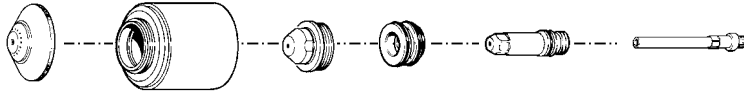

	Plasma gas	Shield	Retaining cap	Nozzle	Swirl ring	Electrode	SilverPlus electrode	Water tube
50 A	O ₂	120186	120185	120182	120179	120178	-----	020963
100 A	O ₂	020424	120837	020690	020613	120547	-----	020963
100 A	Air	020448	120837	020611	020607	120547	-----	020963
200 A	N ₂	020424	120837	020608	020607	020415	-----	020963
200 A	Air	020424	120837	020608	020679	120667	-----	020963
200 A	O ₂	020424	120837	020605	120833	120667	220084	020963
200 A HySpeed	O ₂	220239	220242	220237	220236	220235	-----	020963
200 A Bevel	O ₂	120260	120837	120259	120833	120258	-----	120257
200 A Gouging	Air	020485	120837	020615	020607	120667	-----	020963

Stainless steel/Aluminum

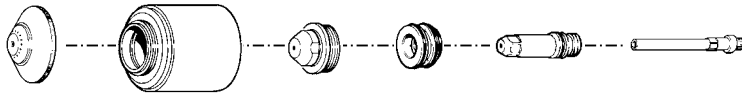

	Plasma gas	Shield	Retaining cap	Nozzle	Swirl ring	Electrode	Water tube
40 A	Air	020688	020423	020689	020613	120667	020963
100 A	H35	020448	120837	020611	020607	020415	020963
100 A	Air	020488	120837	020611	020607	120547	020963
200 A	H35	020602	120837	020608	020607	020415	020963
200 A	N ₂	020424	120837	020608	020607	020415	020963
200 A	Air	020424	120837	020608	020679	120667	020963
200 A Gouging	H35	020485	120837	020615	020607	020415	020963

Water muffler*

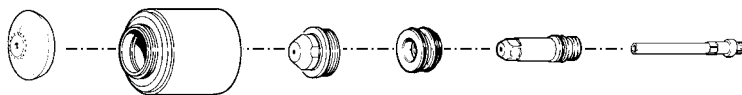

	Plasma gas	Shield	Retaining cap	Nozzle	Swirl ring	Electrode	Water tube
100 A	O ₂	020566	020423	020690	020613	120547	020963
100 A	Air	020618	020423	020611	020607	120547	020963
200 A	O ₂	020566	020423	020605	120833	120667	020963
200 A	Air	020566	020423	020608	020679	120667	020963
200 A	N ₂	020566	020423	020608	020607	020415	020963
200 A HySpeed	O ₂	220295	220238	220237	220236	220235	020963

* Do not use the water muffler when cutting with H35.



TECHNOLOGIES

- Chambered swirl ring™**
- Coaxial-assist™ jet**
- Dimpled electrode**
- HyDefinition®**
- HyLife®**
- Hyspeed®**
- LongLife™**
- SilverPlus®**

Mounting sleeve
(2" outside
diameter)

Mounting sleeve
(1.75" outside
diameter)

Torch assembly options

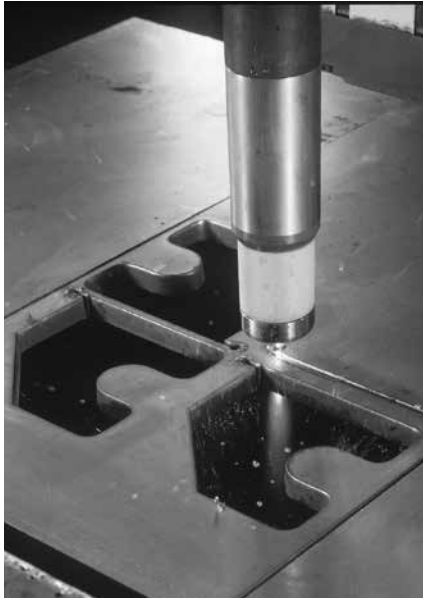

Standard leads

Lead length	Part number
3 m (10')	028657
4.5 m (15')	028658
6 m (20')	028659
7.5 m (25')	028546
9 m (30')	028660
10 m (35')	028661
12 m (40')	028662
14 m (45')	028663
15 m (50')	028547

Mounting sleeves

Description	Length	Diameter	Part number
2" Sleeve	273 mm (10.75")	50.8 mm (2")	120894
1.75" Sleeve	273 mm (10.75")	44.5 mm (1.75")	020431
Stainless steel	298 mm (11.75")	50.8 mm (2")	020041

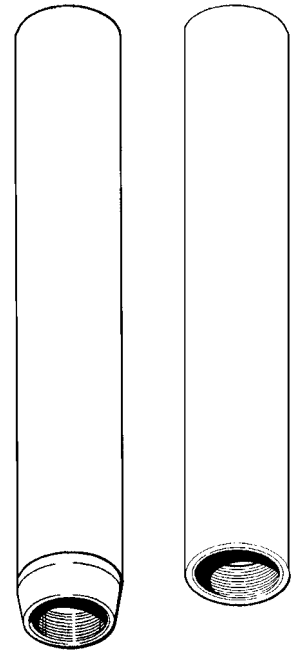

Torch

Description	Part number
Standard	120584
Stainless steel body	120356

Additional parts available (not shown)

Description	Part number
HySpeed HT2000 plasma arc cutting system manual	802070
HySpeed consumable kit	128824
Preventive maintenance kit (torch main body, coolant, light bulb, contactor, relay)	128907
Standard machine torch (torch, receptacle, sleeve, consumables, valve)	128381
Stainless steel machine torch (torch, receptacle, sleeve, consumables, valve)	128367
Standard machine torch – LHF (torch, receptacle, sleeve, consumables, valve)	128255
Stainless steel machine torch – LHF (torch, receptacle, sleeve, consumables, valve)	128369
HT2000 off-valve assembly (when using 2" sleeve)	129470
HT2000 off-valve assembly (when using 1.75" sleeve)	129168
Solenoid valve (120# 1/8" FPT)	006100
Hose (Off-valve to torch main body, 1')	024355
Hose – LHF (Off-valve to torch main body)	024550
Adapter (1.75" – 2" torch mounting sleeve)	020407
Valve mounting bracket (when using 2" sleeve)	120832
Valve mounting bracket (when using 1.75" sleeve)	120492
Valve mounting bracket – LHF (when using 2" sleeve)	220311
O-ring (torch)	044027
Silicon lubricant for o-rings	027055

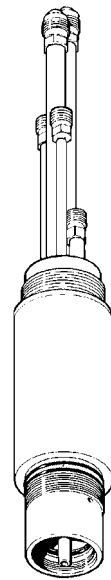

HySpeed HT2000
torch main body

Hypertherm®

HyPro2000™ upgrade torch

For MAX200



Consumables

Air – Mild steel/Stainless steel/Aluminum

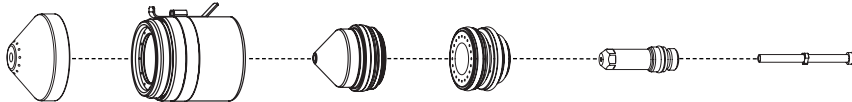

	Shield	Shield cap	Nozzle	Swirl ring	Electrode	Water tube
50 A	220532	220936 220935 without tab	220890	220529	220528	220521
130 A	220536	220936 220935 without tab	220892	220488	220487	220521
200 A	420045	220936 220935 without tab	420044	220488	220937	220521

O₂ – Mild steel

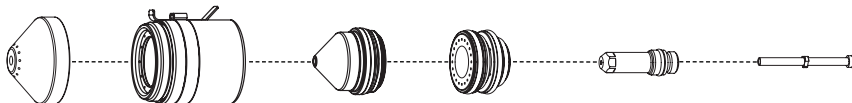

	Shield	Shield cap	Nozzle	Swirl ring	Electrode	Water tube
130 A	220536	220936 220935 without tab	220892	220488	220487	220521
200 A	420045	220936 220935 without tab	420044	220488	220937	220521

N₂ – Stainless steel/Aluminum

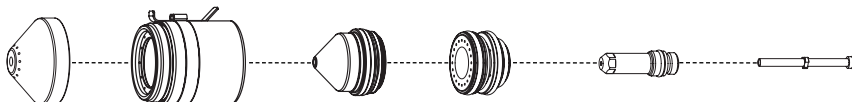

	Shield	Shield cap	Nozzle	Swirl ring	Electrode	Water tube
200 A	420045	220936 220935 without tab	420044	220529	020415	220521

Section 2: Current systems



HyPro2000 straight torch



HyPro2000 quick-disconnect torch

TECHNOLOGIES

- Chambered swirl ring**
- Conical Flow™**
- CoolFlow™**
- LongLife®**
- TrueFlow™**
- Vented shield**
- HyLife®**

HyPro2000™

Torch assembly options

Standard leads

Lead length	Part number
3 m (10')	028454
4.5 m (15')	028455
6 m (20')	028456
7.5 m (25')	028383
9 m (30')	028457
10 m (35')	028458
12 m (40')	028459
14 m (45')	028460
15 m (50')	028384
18 m (60')	028773
23 m (75')	028599
30 m (100')	028781

Mounting sleeves

Description	Length	Diameter	Part number
Standard	279.4 mm (11")	50.8 mm (2")	220943
Standard	279.4 mm (11")	44.45 mm (1.75")	220942

Quick-disconnect receptacle 220913

HyPro2000 Quick-disconnect torch 220921

HyPro2000 Straight torch 220961

Torch upgrade kit – HyPro2000 for MAX200 quick-disconnect 228908

Includes: machine torch (loaded with consumables), quick-disconnect receptacle, mounting sleeves (2" and 1.75"), 200 A Air/O₂ electrodes (2), 200 A Air/O₂ nozzles (2), silicon lubricant for o-rings, consumable removal tool, plastic tube for hoses, plasma gas extension hose, operating manual.

Torch upgrade kit – HyPro2000 for MAX200 straight torch with 45 mm (1.75") sleeve 428256

Includes: machine torch (loaded with 200 A consumables), mounting sleeve 45 mm (1.75"), silicon lubricant for o-rings, consumable removal tool, plastic tube for hoses, 200 A Air cut charts.

Torch upgrade kit – HyPro2000 for MAX200 straight torch with 50 mm (2") sleeve 428255

Includes: machine torch (loaded with 200 A consumables), mounting sleeve 50 mm (2"), silicon lubricant for o-rings, consumable removal tool, plastic tube for hoses, 200 A Air cut charts.

Additional parts available (not shown)

Consumables removal tool	104119
Silicon lubricant for o-rings	027055

Mounting sleeve
(2" outside
diameter)



Mounting sleeve
(1.75" outside
diameter)

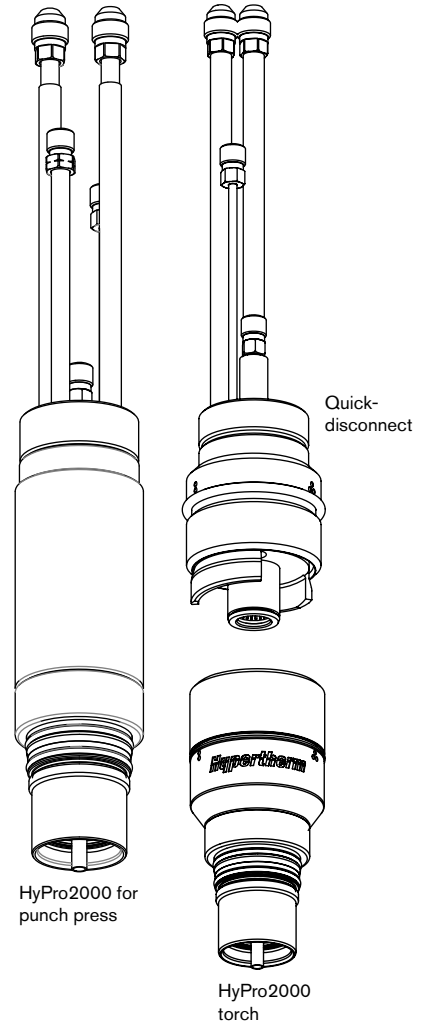

Hypertherm®

MAX200

MAX200 machine torch consumables



Mild steel

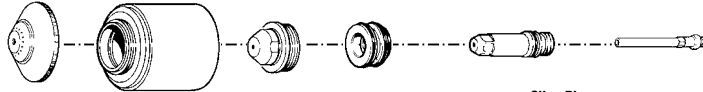

	Plasma gas	Shield	Retaining cap	Nozzle	Swirl ring	Electrode	SilverPlus electrode	Water tube
40 A	Air	020688	020423	020689	020613	120547	-----	020963
100 A	O ₂	020448	120837	020616	020617	120547	-----	020963
100 A	Air	020448	120837	020611	020607	120547	-----	020963
200 A	N ₂	020424	120837	020608	020607	020415	-----	020963
200 A	Air	020424	120837	020608	020607	220021	-----	020963
200 A	O ₂	020424	120837	020605	020604	220021	220083	020963
200 A Gouging	Air	020485	020423	020615	020607	220021	-----	020963
200 A Bevel	O ₂	120260	020423	120259	120833	120258	-----	120257

Stainless steel

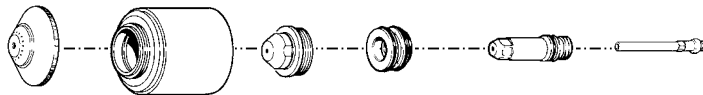

	Plasma gas	Shield	Retaining cap	Nozzle	Swirl ring	Electrode	Water tube
40 A	Air	020514	020423	020689	020613	120547	020963
100 A	Air	020448	120837	020611	020607	120547	020963
100 A	H35	020448	120837	020611	020607	020415	020963
200 A	Air	020424	120837	020608	020607	220021	020963
200 A	H35	020602	120837	020608	020607	020415	020963
200 A	N ₂	020424	120837	020608	020607	020415	020963
200 A Gouging	H35/N ₂	020485	020423	020615	020607	220021	020963

Aluminum

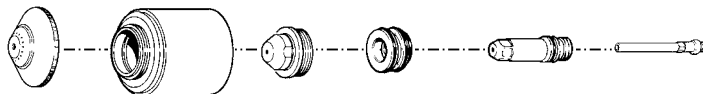

	Plasma gas	Shield	Retaining cap	Nozzle	Swirl ring	Electrode	Water tube
40 A	Air	020514	020423	020689	020613	120547	020963
100 A	Air	020448	120837	020611	020607	120547	020963
100 A	H35	020448	120837	020611	020607	020415	020963
200 A	Air	020448	120837	020608	020607	220021	020963
200 A	N ₂ /Air	020424	120837	020611	020607	020415	020963
200 A	N ₂ /CO ₂	020424	120837	020608	020607	020415	020963
200 A	H35/N ₂	020602	120837	020608	020607	020415	020963
200 A Gouging	H35/N ₂	020485	020423	020615	020607	220021	020963

Under water cutting

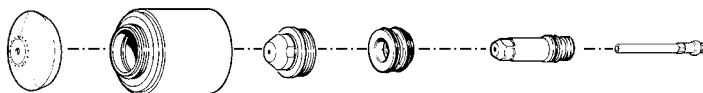

	Plasma gas	Shield	Retaining cap	Nozzle	Swirl ring	Electrode	Water tube
100 A	Air	020488	020423	020611	020607	120547	020963
100 A	O ₂	020448	020423	020616	020617	120547	020963
200 A	Air	020424	020423	020608	020607	220021	020963
200 A	O ₂	020424	020423	020605	020604	220021	020963
200 A	O ₂ (SS)	020424	020423	020608	020607	220021	020963
200 A	N ₂	020424	020423	020608	020607	020415	020963

* Do not use the water muffler when cutting with H35.



128380 – Standard body – 2" sleeve



120356 – Stainless steel body

TECHNOLOGIES

Chambered swirl ring™

HyLife®

SilverPlus®

Vented shield™

MAX200

Torch and valve assembly options



Standard leads

Lead length	Part number
3 m (10')	028454
4.5 m (15')	028455
6 m (20')	028456
7.5 m (25')	028383
9 m (30')	028457
10 m (35')	028458
12 m (40')	028459
14 m (45')	028460
15 m (50')	028384
18 m (60')	028773
23 m (75')	028599

Mounting sleeves

Description	Diameter	Part number
2" Sleeve	50.8 mm (2")	120894
1.75" Sleeve	44.5 mm (1.75")	020431
2" Sleeve for stainless steel torch	50.8 mm (2")	020041

Torch

Description	Diameter	Part number
Standard	44.5 mm (1.75")	120584
Stainless steel	50.8 mm (2")	120356

Additional parts available (not shown)

Description	Part number
MAX200 Plasma arc cutting system manual	800980
Consumables starter kit	028392
Consumables starter kit (international)	028429
Preventive maintenance kit (torch main body, coolant, light bulb, contactor, relay)	228010
Machine torch – 2" sleeve (torch, 2" sleeve, consumables)	128380
Machines torch – 1.75" sleeve (torch, 1.75" sleeve, consumables)	128364
Stainless steel machine torch (torch, sleeve, consumables)	128365
Lead insulator (9/16 X 2.5 Tef)	020536
O-ring (Burna-N)	044027
Silicon lubricant for o-rings	027055

 Selected consumables are no longer available.
Contact Hypertherm for recommended alternative products

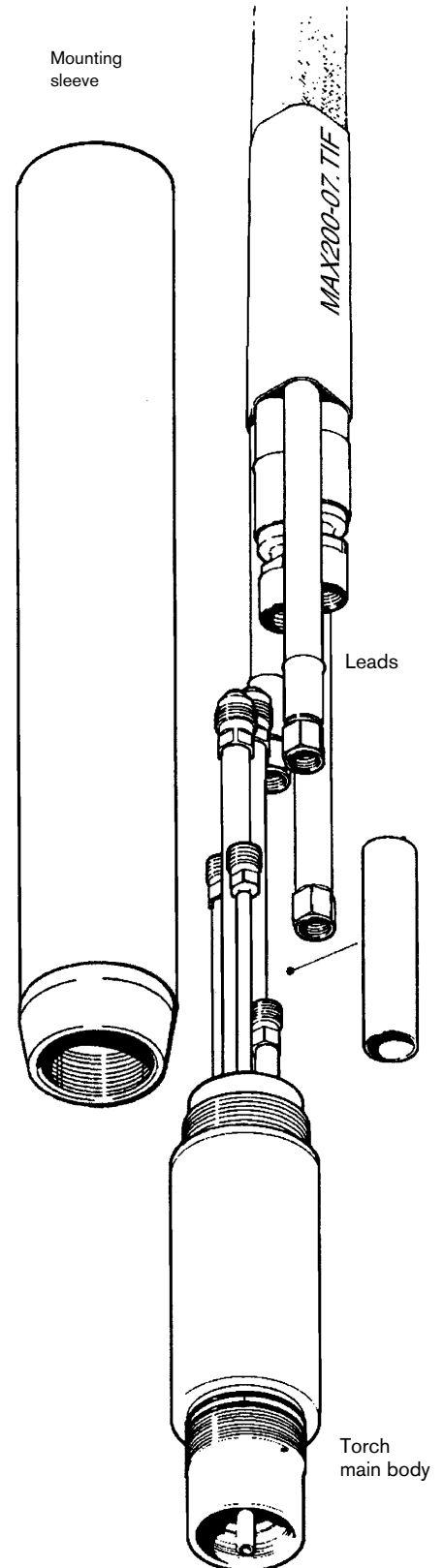

Hypertherm®

MAX200

PAC200 T/E hand torch consumables



Shielded consumables

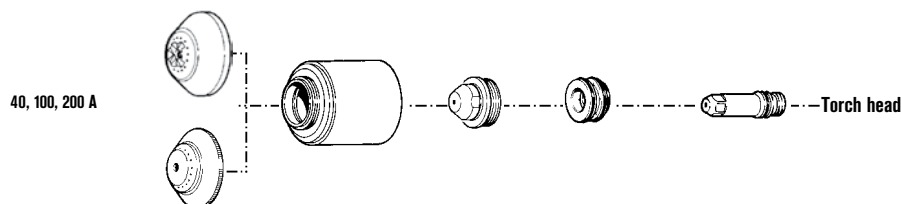

Metal	Plasma gas	Shield gas	Amps	Shield	Retaining cap	Nozzle	Swirl ring	Electrode
Mild steel/ stainless/ aluminum	Air	Air	40 A	020917	020915	020689	020613	120547
	Air	Air	100 A	020919	020915	020611	020607	120547
	Air	Air	200 A	020918	020915	020608	020607	220021
Stainless steel/ aluminum	Nitrogen (N ₂)	Carbon dioxide (CO ₂)	200 A	020918	020915	020608	020607	020415
	H35	Nitrogen (N ₂)	100 A	020919	020915	020611	020607	020415
Mild steel	Nitrogen (N ₂)	Air	200 A	020918	020915	020608	020607	020415
	Oxygen (O ₂)	Air	100 A	020919	020915	020616	020617	220021
Stainless steel	Oxygen (O ₂)	Air	200 A	020918	020915	020605	020604	220021
	H35	Nitrogen (N ₂)	200 A	020920	020915	020608	020607	020415
Aluminum	H35	Nitrogen (N ₂)	200 A	020918	020915	020608	020607	020415



PAC200T hand torch

Gouging consumables

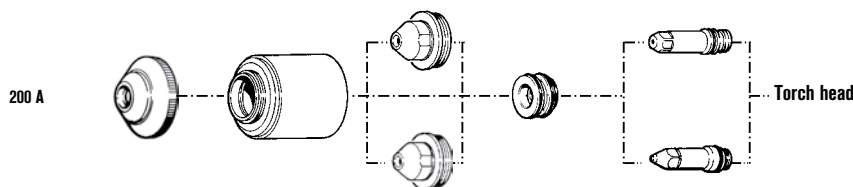

Metal	Plasma gas	Shield gas	Amps	Shield	Retaining cap	Nozzle	Swirl ring	Electrode
Mild steel	Air	Air	200 A	020891	020882	020615	020607	220021
	H35	Air	200 A	020891	020882	020934	020607	020933
Stainless steel/ aluminum	H35	Nitrogen (N ₂)	200 A	020891	020882	020934	020607	020933



PAC200E gouging torch

* In countries following CE standards, unshielded consumables may only be used in mechanized torch applications.

MAX200

PAC200T/E hand and gouging torch assemblies

Section 2: Current systems

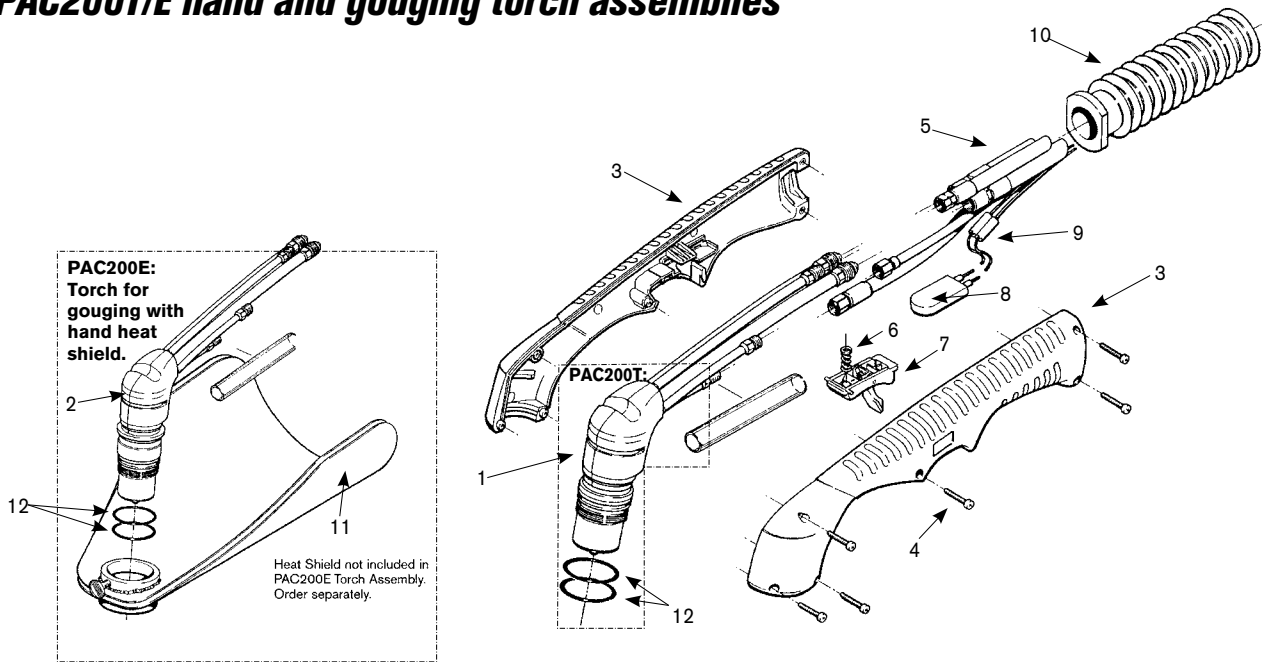

Assembly

Part number	Description
073189*	PAC200T 90° hand cutting torch assembly with 25' (7.6 m) leads
073190*	PAC200T 90° hand cutting torch assembly without leads
073111*	PAC200E 65° hand gouging torch assembly with 25' (7.6 m) leads
073188*	PAC200E gouging torch assembly without leads
029865	Torch-to-power supply with 25' (7.6 m) leads
028715	Torch-to-power supply with 50' (15.2 m) leads
028716	Torch-to-power supply with 75' (22.9 m) leads
028717	Torch-to-power supply with 100' (30.5 m) leads
028718	Torch-to-power supply with 125' (38.1 m) leads
028719	Torch-to-power supply with 150' (45.8 m) leads
1. 120045	Torch main body, PAC200T hand torch 90°
2. 020908	Torch main body, PAC200E gouging torch 65°
3. 001412	Handle, PAC200T 90° (both halves included)
001440	Handle, PAC200E 65° (both halves included) (not shown)
4. 075365	Screw, #6 x 3/4", phillips head, pan (six required)
5. 046065	Insul. tube, 9/16 ID x.03 WL, PTFE** (included with lead sets)
6. 027254	Trigger spring, PAC200T/E
7. 002244	Safety trigger, PAC200T/E
8. 005094	Push button switch (included with lead sets listed above)
9. 074069	Splice (two required)
10. 001217	Boot
11. 020881	Hand heat shield, PAC200E gouging torch
12. 044027	O-ring, Buna (two required)
027347	Water tube removal tool
023345	Work lead with clamp 25' (7.6 m)
023420	Work lead with clamp 50' (15.2 m)

*Assembly includes consumables

**PolyTetraFluoroEthylene is a fluorocarbon-based polymer and is commonly abbreviated PTFE. The Teflon® brand of PTFE is manufactured only by DuPont and is not sold by Hypertherm. Hypertherm purchases other brands of PTFE from various high quality manufacturers.



Hypertherm®

HyPerformance® Plasma HPR260®



Consumables

Mild steel

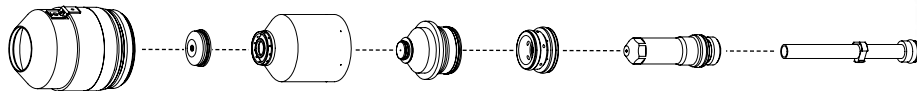

	Shield cap	Shield	Nozzle retaining cap	Nozzle	Swirl ring	Electrode	SilverPlus electrode	Water tube
30 A	220173	220194	220313	220193	220180	220192	-----	220340
50 A	220173	220555	220313	220554	220553	220552	-----	220340
80 A	220173	220189	220176	220188	220179	220187	-----	220340
130 A	220173	220183	220176	220182	220179	220181	220665	220340
200 A	220398	220356	220355	220354	220353	220352	220666	220340
260 A	220398	220440	220433	220439	220436	220435	220668	220340
130 A bevel	220398	220645	220603	220646	220179	220649	-----	220700
260 A bevel	220398	220545	220603	220542	220436	220541	-----	220571

Stainless steel

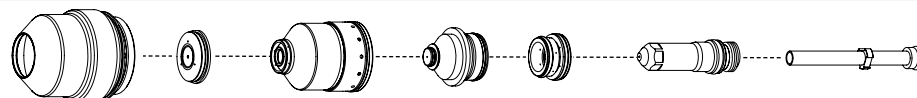

	Shield cap	Shield	Nozzle retaining cap	Nozzle	Swirl ring	Electrode	Water tube
45 A	220173	220202	220304	220201	220180	220308	220340
80 A	220173	220338	220304	220337	220179	220339	220340
130 A	220173	220198	220304 (H35) 220176 (N ₂)	220197	220179	220307	220340
200 A	220398	220345	220344	220343	220342	220307	220340
260 A	220398	220407	220344	220406	220405	220307	220340
130 A bevel	220398	220609	220656 (H35) 220608 (N ₂)	220656	220179	220606	220571
260 A bevel	220398	220609	220608	220607	220405	220606	220571

Aluminum

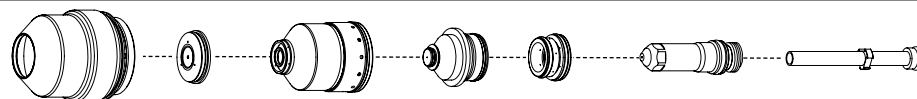

	Shield cap	Shield	Nozzle retaining cap	Nozzle	Swirl ring	Electrode	Water tube
45 A	220173	220202	220176	220201	220180	220308	220340
130 A	220173	220198	220304 (H35) 220176 (Air)	220197	220179	220307 (H35) 220181 (Air)	220340
200 A	220398	220345	220347	220346	220342	220307	220340
260 A	220398	220407	220344	220406	220405	220307	220340

TECHNOLOGIES

Chambered swirl ring™
Conical Flow™
CoolFlow™
Dimpled electrode
HyDefinition®
HyLife®
LongLife®
SilverPlus®
TrueFlow™

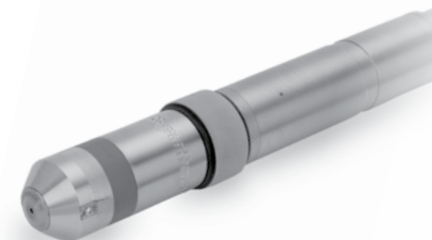

HyPerformance® Plasma HPR260®

Torch assembly options



Standard leads

Lead length	Part number	
	6' gas	8' gas
2 m (6')	128986	-----
3 m (10')	128935	-----
4.5 m (15')	128934	228040
7.5 m (25')	128784	228043
10 m (35')	128987	228065
15 m (50')	128785	220458
20 m (65')	128988	228066

Robotic/Bevel leads

Lead length	Part number	
	6' gas	8' gas
2 m (6')	228075	-----
3 m (10')	228076	228077
4.5 m (15')	228079	228061
7.5 m (25')	228081	228062
10 m (35')	228083	228084
15 m (50')	228086	228063
20 m (65')	228088	228089

Mounting sleeves

Description	Length	Diameter	Part number
Standard	199 mm (7.8")	50.8mm (2")	220232
Extended	283 mm (11")	50.8mm (2")	220516
Bevel/Rotational (included in bevel receptacle)	126 mm (5")	50.8mm (2")	220546

Quick-disconnect receptacle

Description	Part number
Standard	220163
Bevel (includes sleeve)	220573

HyPerformance quick-disconnect torch

Additional parts available (not shown)

Description	Part number
Consumables starter kit (All amps, mild steel, aluminum, stainless steel)	228027
Machine torch (Torch, receptacle, sleeve, 130 A MS consumables)	128818
Preventive maintenance kit (Machine torch, coolant, filter, coil, relay, o-rings, water tube)	228016
Silicon lubricant for o-rings	027055
2" spanner wrench	104269
Electrode pit depth gauge	004630
Consumables removal tool	104119
HPR260 Manual gas instruction manual	804940
HPR260 Auto gas instruction manual	805000

 Selected consumables are no longer available.
Contact Hypertherm for recommended alternative products

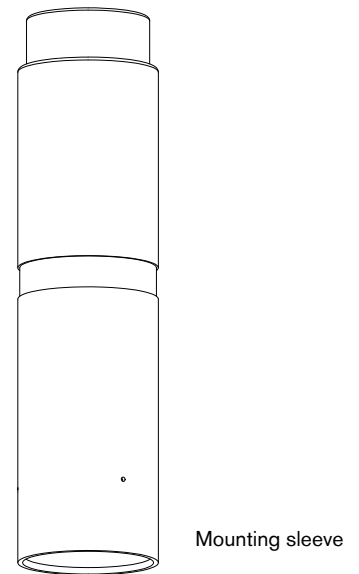

Mounting sleeve

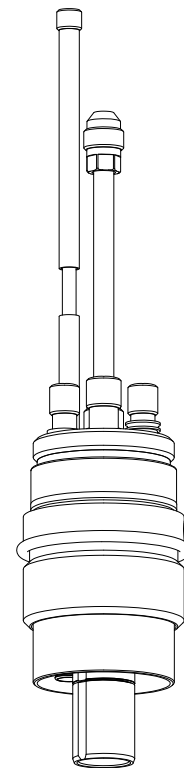

Quick-disconnect receptacle

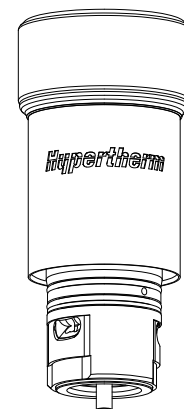

HPR quick-disconnect torch

Hypertherm®

HyPerformance® Plasma HPR130®



Consumables

Mild steel

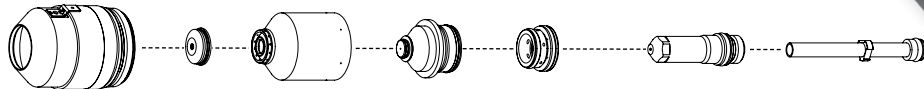

	Shield cap	Shield	Nozzle retaining cap	Nozzle	Swirl ring	Electrode	SilverPlus electrode	Water tube
30 A	220173	220194	220313	220193	220180	220192	-----	220340
50 A	220173	220555	220313	220554	220553	220552	-----	220340
80 A	220173	220189	220176	220188	220179	220187	-----	220340
130 A	220173	220183	220176	220182	220179	220181	220665	220340
130 A bevel	220398	220645	220603	220646	220179	220649	-----	220700

Stainless steel

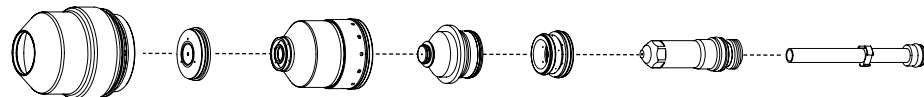

	Shield cap	Shield	Nozzle retaining cap	Nozzle	Swirl ring	Electrode	Water tube
45 A	220173	220202	220304	220201	220180	220308	220340
80 A	220173	220338	220304	220337	220179	220339	220340
130 A	220173	220198	220304 (H35)	220197	220179	220307	220340
			220176 (N ₂)				
130 A bevel	220398	220609	220656 (H35)	220656	220179	220606	220571
			220608 (N ₂)				

Aluminum

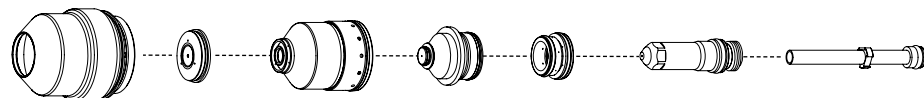

	Shield cap	Shield	Nozzle retaining cap	Nozzle	Swirl ring	Electrode	Water tube
45 A	220173	220202	220176	220201	220180	220308	220340
130 A	220173	220198	220304 (H35)	220197	220179	220307 (H35)	220340
			220176 (Air)			220181 (Air)	

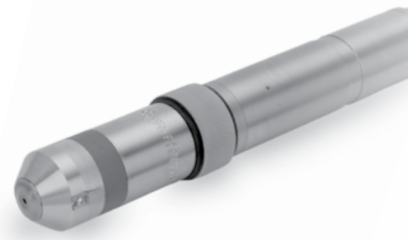

TECHNOLOGIES

- Chambered swirl ring™**
- Conical Flow™**
- Dimpled electrode**
- HyDefinition®**
- HyLife®**
- LongLife®**
- SilverPlus®**
- TrueFlow™**

Section 3: Legacy systems

HyPerformance® Plasma HPR130®

Torch assembly options



Standard leads

Lead length	Part number	
	6' gas	8' gas
2 m (6')	128986	-----
3 m (10')	128935	-----
4.5 m (15')	128934	228040
7.5 m (25')	128784	228043
10 m (35')	128987	228065
15 m (50')	128785	220458
20 m (65')	128988	228066

Robotic/Bevel leads

Lead length	Part number	
	6' gas	8' gas
2 m (6')	228075	-----
3 m (10')	228076	228077
4.5 m (15')	228079	228061
7.5 m (25')	228081	228062
10 m (35')	228083	228084
15 m (50')	228086	228063
20 m (65')	228088	228089

Mounting sleeves

Description	Length	Diameter	Part number
Standard	199 mm (7.8")	50.8mm (2")	220232
Extended	283 mm (11")	50.8mm (2")	220516
Bevel/Rotational (included in bevel receptacle)	126 mm (5")	50.8mm (2")	220546

Quick-disconnect receptacle

Description	Part number
Standard	220163
Bevel (includes sleeve)	220573

HyPerformance quick-disconnect torch

220162

Additional parts available (not shown)

Description	Part number
Consumables starter kit (All amps, mild steel, aluminum, stainless steel)	128878
Machine torch (Torch, receptacle, sleeve, 130 A MS consumables)	128818
Preventive maintenance kit (Machine torch, coolant, filter, coil, relay, o-rings, water tube)	228015
Silicon lubricant for o-rings	027055
2" spanner wrench	104269
Electrode pit depth gauge	004630
Consumables removal tool	104119
HPR130 Manual Gas Instruction Manual	804570
HPR130 Auto Gas Instruction Manual	804960

 Selected consumables are no longer available. Contact Hypertherm for recommended alternative products

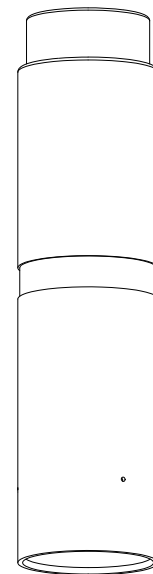

Mounting sleeve

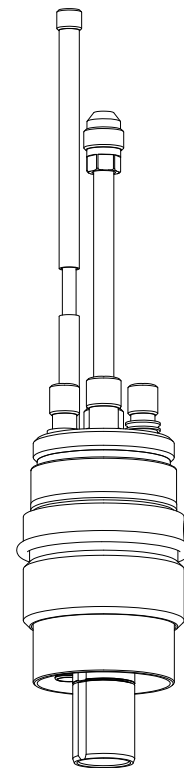

Quick-disconnect receptacle

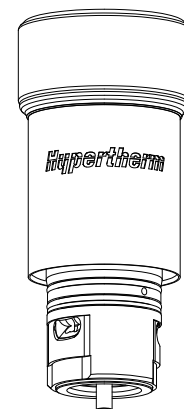

HPR quick-disconnect torch

XD upgrade kits for HPR130 and HPR260

What to order

	Part number
1. Upgrade kit includes:	228524
<ul style="list-style-type: none"> ▪ New control board with firmware for the power supply ▪ Gas console firmware for both auto gas selection console and metering console, and tool to remove firmware chips ▪ Adapter fittings for metering console, to connect new torch leads to old style connectors on metering console) ▪ Field service bulletin ▪ XD and PowerPierce labels 	
2. New XD machine torch assembly includes a quick-disconnect torch and receptacle, torch sleeve – length 181 mm (7"), and 1 set of consumables:	
Description	Part number
HPR130XD torch with list of 130 A bevel consumables	228520
HPR260XD torch with list of 260 A bevel consumables	228521
HPR130XD torch with list of 130 A consumables	228633
HPR260XD torch with list of 260 A consumables	228634
3. New torch leads: Bevel torch leads are also available	
Description	Part number
Standard torch leads, 2 m / 6'	228291
Standard torch leads, 3 m / 10'	229292
Standard torch leads, 4.5 m / 15'	228293
Standard torch leads, 6 m / 20'	228294
Standard torch leads, 7.5 m / 25'	228295
Standard torch leads, 10 m / 35'	228296
Standard torch leads, 15 m / 50'	228297
Standard torch leads, 20 m / 65'	228547
4. IHS ohmic contact wire, necessary for ohmic sensing:	
Description	Part number
IHS ohmic contact wire, 3 m / 10'	123983
IHS ohmic contact wire, 6 m / 20'	123984
IHS ohmic contact wire, 7.5 m / 25'	123985
IHS ohmic contact wire, 9 m / 30'	123986
IHS ohmic contact wire, 12 m / 40'	123987
IHS ohmic contact wire, 15 m / 50'	123988
IHS ohmic contact wire, 23 m / 75'	123989
IHS ohmic contact wire, 30 m / 100'	123990
IHS ohmic contact wire, 45 m / 150'	123991

Marking and True Hole require HPRXD auto gas selection console 078533.

Hypertherm®

XD Technology upgrade kit for HyperPerformance Plasma HPR130 and HPR260

Hypertherm, HyPerformance, HPR, Advanced axial swirl ring, Chambered swirl ring, Conical Flow, CoolCore, CoolFlow, HyDefinition, HyLife, LongLife, PowerPierce, SilverPlus, TrueFlow, Vented shield and HD are trademarks of Hypertherm, Inc. and may be registered in the United States and/or other countries

Hypertherm®

HyPerformance® HD4070®



Consumables

Mild steel

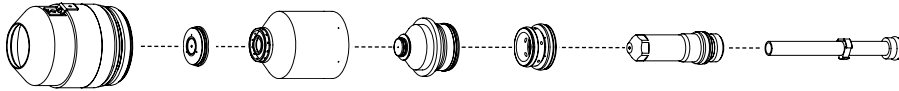

	Shield cap	Shield	Nozzle retaining cap	Nozzle	Swirl ring	Electrode	Water tube
30 A	220173	220194	220313	220193	220180	220192	220340
50 A	220173	220555	220313	220554	220553	220552	220340
80 A	220173	220189	220176	220188	220179	220187	220340
130 A	220173	220183	220176	220182	220179	220181	220340
200 A	220398	220356	220355	220354	220353	220352	220340

Stainless steel

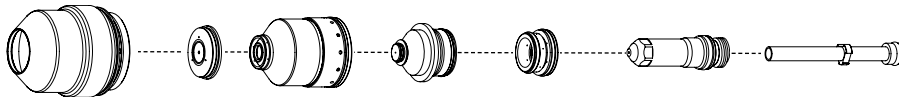

	Shield cap	Shield	Nozzle retaining cap	Nozzle	Swirl ring	Electrode	Water tube
45 A	220173	220202	220304	220201	220180	220308	220340
80 A	220173	220338	220304	220337	220179	220339	220340
130 A	220173	220198	220304	220197	220179	220307	220340
200 A	220398	220345	220344	220343	220342	220307	220340

Aluminum

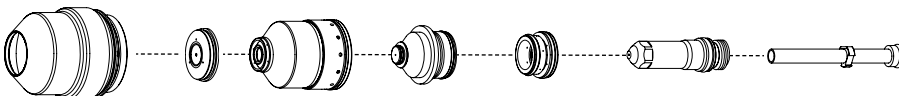

	Shield cap	Shield	Nozzle retaining cap	Nozzle	Swirl ring	Electrode	Water tube
45 A	220173	220202	220176	220201	220180	220308	220340
130 A	220173	220198	220304	220197	220179	220307	220340
200 A	220398	220345	220347	220346	220342	220307	220340

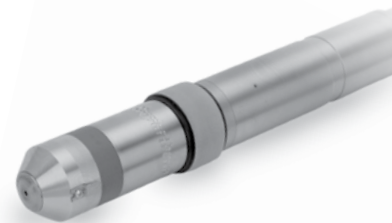

TECHNOLOGIES

Chambered swirl ring™
Conical Flow™
Dimpled electrode
HyDefinition®
HyLife®
LongLife™
Quick disconnect
SilverPlus®
TrueFlow™

HyPerformance® HD4070*

Torch assembly options

Mounting sleeve

Description	Length	Diameter	Part number
Standard	199 mm (7.8")	50.8 mm (2")	220232
Extended	283 mm (11")	50.8 mm (2")	220516

Quick-disconnect receptacle

Description	Part number
Standard	220163
Bevel (includes sleeve)	220573

HyPerformance quick-disconnect torch

Description	Part number
Standard (used in all applications)	220162

Additional parts available (not shown)

Description	Part number
Preventive maintenance kit (Machine torch, coolant, filter, coil, relay, o-rings, water tube)	228014
Machine torch (Torch, receptacle, extended sleeve, 130 A MS consumables)	228048
Torch kit (O-rings, seal, water tube)	128879
Quick-disconnect kit (O-ring and connector)	128880
2" spanner wrench	104269
Electrode pit depth gauge	004630
Consumables removal tool	104119
Silicon lubricant for o-rings	027055
HyPerformance HD4070 Instruction Manual	804900



Leads



Mounting sleeve



Quick-disconnect receptacle



HPR quick-disconnect torch

Hypertherm®

HyPerformance® HD3070®



Consumables

Mild steel

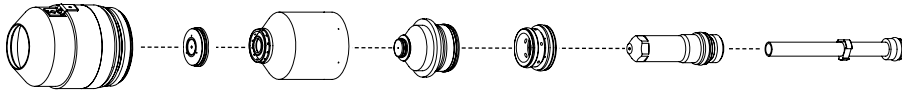

	Shield cap	Shield	Nozzle retaining cap	Nozzle	Swirl ring	Electrode	Water tube
30 A	220173	220194	220313	220193	220180	220192	220340
50 A	220173	220555	220313	220554	220553	220552	220340
80 A	220173	220189	220176	220188	220179	220187	220340
100 A	220173	220183	220176	220510	220179	220181	220340

Stainless steel

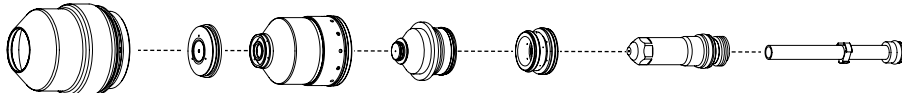

	Shield cap	Shield	Nozzle retaining cap	Nozzle	Swirl ring	Electrode	Water tube
45 A	220173	220202	220304	220201	220180	220308	220340
70 A	220173	220189	220176	220188	220179	220187	220340
80 A	220173	220338	220304	220337	220179	220339	220340
100 A	220173	220627	220644	220626	220640	220641	220340

Aluminum

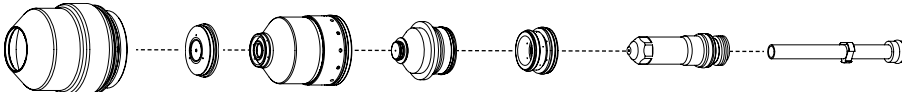

	Shield cap	Shield	Nozzle retaining cap	Nozzle	Swirl ring	Electrode	Water tube
45 A	220173	220202	220176	220201	220180	220308	220340
70 A	220173	220198	220176	220188	220179	220187	220340
100 A	220173	220627	220664	220626	220640	220641	220340



TECHNOLOGIES

- Chambered swirl ring™**
- Conical Flow™**
- Dimpled electrode**
- HyDefinition®**
- HyLife®**
- LongLife™**
- Quick disconnect**
- SilverPlus®**
- TrueFlow™**

HyPerformance® HD3070*

Torch assembly options



Leads (with blow back option)

Lead length	Part number
4.5 m (15')	028866
6 m (20')	028867
7.5 m (25')	028868
9 m (30')	028869
10 m (35')	028695
12 m (40')	028870
15 m (50')	128001
23 m (75')	128083
30 m (100')	128084

Leads (without blow back option)

Lead length	Part number
4.5 m (15')	028498
6 m (20')	028499
7.5 m (25')	028500
9 m (30')	028501
10 m (35')	028502
12 m (40')	028503
15 m (50')	128132
23 m (75')	128133
30 m (100')	128134

Mounting sleeve

Description	Length	Diameter	Part number
Standard	254 mm (10")	50.8 mm (2")	220624

Quick-disconnect receptacle

Description	Part number
Standard	220163
Bevel (includes sleeve)	220573

HyPerformance quick-disconnect torch

Description	Part number
Standard (used in all applications)	220162

Additional parts available (not shown)

Description	Part number
Field Service Bulletin	805390
Retrofit kit	228132
Preventive maintenance kit (Machine torch, coolant, filter, coil, relay, o-rings, water tube)	228168
Machine torch (Torch, receptacle, sleeve, 130 A MS consumables)	228133
Torch kit (O-rings, seal, water tube)	128879
Quick-disconnect kit (O-ring and connector)	128880
2" spanner wrench	104269
Electrode pit depth gauge	004630
Consumables removal tool	104119
Silicon lubricant for o-rings	027055



Leads



Mounting sleeve



Quick-disconnect receptacle



HPR quick-disconnect torch

Hypertherm, HyPerformance, HPR, Advanced axial swirl ring, Chambered swirl ring, Conical Flow, CoolCore, CoolFlow, HyDefinition, HyLife, LongLife, PowerPierce, SilverPlus, TrueFlow, Vented shield and HD are trademarks of Hypertherm, Inc. and may be registered in the United States and/or other countries

Hypertherm®

HyDefinition® HD4070



Consumables

Mild steel

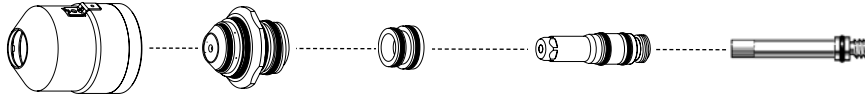

	Shield cap*	Nozzle	Swirl ring	Electrode	Water tube
30 A	120786	120678	120677	120676	120025
70 A	120786	120685	120684	120683	120025
100 A	120786	120660	120655	120654	120025
200 A	120786	120692	120691	120690	120025
		220081 (ccw)	220080 (ccw)		

Stainless steel

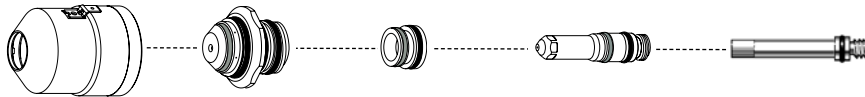

	Shield cap*	Nozzle	Swirl ring	Electrode	Water tube
45 A	120786	120706	120705	120704	120025
70 A	120786	120713	120712	120711	120025
100 A	120786	120720	120719	120718	120025
200 A	120786	120727	120726	120725	120025

Aluminum

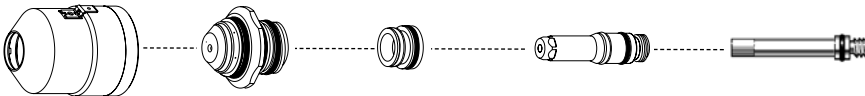

	Shield cap*	Nozzle	Swirl ring	Electrode	Water tube
45 A	120786	120741	120740	120739	120025
70 A	120786	120748	120747	120746	120025
100 A	120786	120755	120754	120753	120025
200 A	120786	120762	120761	120760	120025

Marking

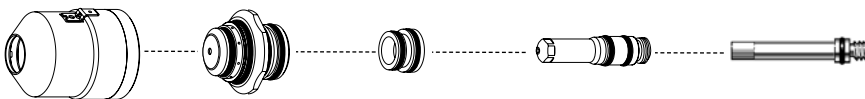

	Shield cap*	Nozzle	Swirl ring	Electrode	Water tube
	120786	120671	120670	120669	120025

* 120907 with IHS tab

 Selected consumables are no longer available. Contact Hypertherm for recommended alternative products



TECHNOLOGIES

Chambered swirl ring™

HyLife®

SilverPlus®

Vented shield™

HyDefinition® HD4070®

Torch assembly options

Torch assembly

Description	Part number
Torch with 6' (2 m) leads	128500
Torch with 10' (3 m) leads	128501
Torch with 15' (4.5 m) leads	128502

Torch

Description	Part number
Standard	120651

Additional parts available (not shown)

Description	Part number
Preventative maintenance kit (Torch, o-ring kit, o-rings, coolant, coolant filter, contactor, and relay)	228013
Electrode pit depth gauge	004147
Electrode removal tool	027102
Consumables removal tool	004663
Water tube removal tool	027347
Silicon lubricant for o-rings	027055



HyDefinition
HD4070 torch

Hypertherm®

HyDefinition® HD3070®

PAC186 torch consumables

Mild steel

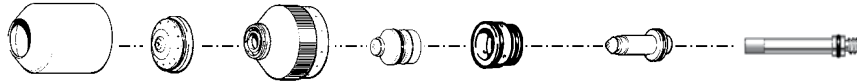

	Shield cap*	Shield	Nozzle retaining cap	Nozzle	Swirl ring	Electrode	SilverPlus electrode	Water tube
15 A	020634	020670	020633	020644	020637	120111	-----	120377
30 A	020634	020671	020633	020645	020637	120111	-----	120377
50 A	020634	020671	020633	020646	020637	120112	-----	120377
70 A	020634	020796	020795	020647	020789	120112	-----	120377
100 A	020634	120273	120266	120272	020637	120410	220408	120377

Stainless steel

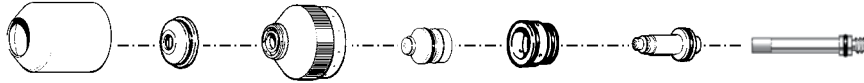

	Shield cap*	Shield	Nozzle retaining cap	Nozzle	Swirl ring	Electrode	Water tube
30 A	020634	020941	020940	020938	020937	120113	120377
50 A	020634	020949	020795	020948	020947	120113	120377
70 A	020634	020796	020795	020647	020789	120112	120377
100 A	020634	120594	120592	120591	120590	120589	120377

Aluminum

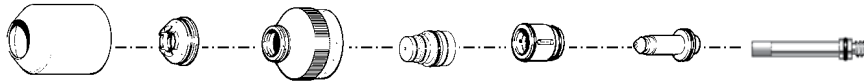

	Shield cap*	Shield	Nozzle retaining cap	Nozzle	Swirl ring	Electrode	Water tube
70 A	020634	020796	020795	020647	020789	120112	120377

Copper

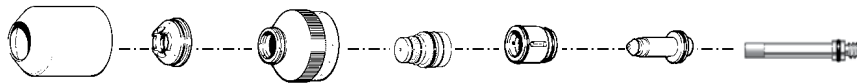

	Shield cap*	Shield	Nozzle retaining cap	Nozzle	Swirl ring	Electrode	Water tube
50 A	020634	020949	020795	020948	020947	120113	120377
70 A	020634	020796	020795	020647	020789	120112	120377



PAC184 torch



PAC186 torch

TECHNOLOGIES

Chambered swirl ring™

HyLife®

SilverPlus®

Vented shield™

* 020687 with IHS tab

Torch assembly options

Cooling supply hose

Lead length	Part number
1.2 m (4')	024421
4.6 m (15')	024290
7.5 m (25')	024291
15 m (50')	024263
23 m (75')	024264
30.5 m (100')	024265
35 m (115')	024385
38 m (125')	024396
46 m (150')	024459

Mounting sleeve

Description	Part number
PAC184 sleeve	120256
PAC186 sleeve	020668
45 degree quick disconnect	028840
Straight quick disconnect	028855

Torch main body

Description	Part number
PAC184, torch	120208
PAC186, torch	120349

Additional parts available (not shown)

Description		Part number
PAC184 Machine torch	(torch, 30 A consumables, shield cap with IHS tab)	128199
PAC184 Machine torch	(torch, 30 A consumables, shield cap without IHS tab)	028839
PAC186 Machine torch	(torch, 15 A consumables, shield cap with IHS tab)	128102
PAC186 Machine torch	(torch, 15 A consumables, shield cap without IHS tab)	128102
Off-value assembly	(with blow back solenoid)	129056
Off-value assembly	(without blow back solenoid)	129174
Preventive maintenance kit	(Machine torch, coolant, filter, coil, relay, o-rings, water tube)	228012
Silicon lubricant for o-rings		027055

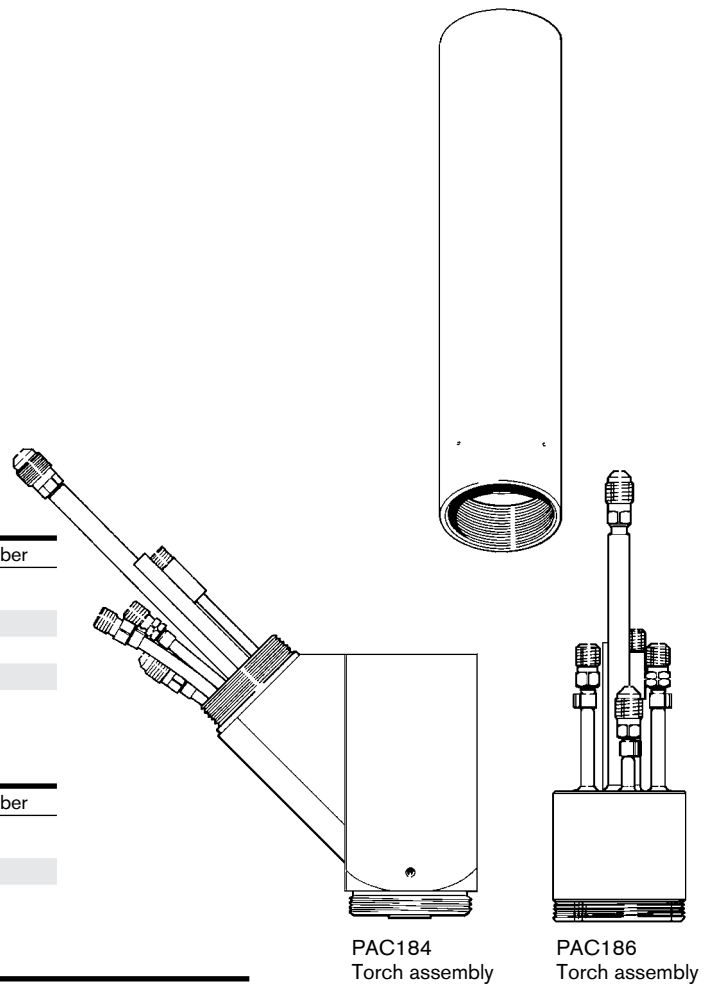

PAC184
Torch assembly

PAC186
Torch assembly



PAC184
Torch main
body



PAC186
Torch main
body

Hypertherm®

HySpeed® HT4400®



Consumables

O₂ – Mild steel

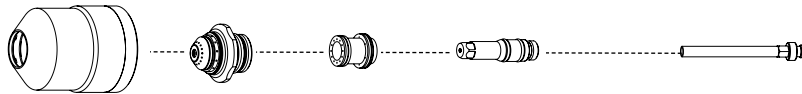

	Retaining cap*	Nozzle	Swirl ring	Electrode	SilverPlus electrode	Water tube
100 A	120786	120777	120783	120785	-----	120025
100 A CCW	120786	120778	120784	120785	-----	120025
200 A	120786	120787	120791	120793	220412	120025
200 A CCW	120786	120788	120792	120793	220412	120025
300 A	120786	120794	120913	120802	220412	120025
300 A CCW	120786	120795	120914	120802	220412	120025
400 A	120786	120934	120939	120810	220412	120025
400 A CCW	120786	120935	120940	120810	220412	120025

N₂ – Stainless steel/Aluminum

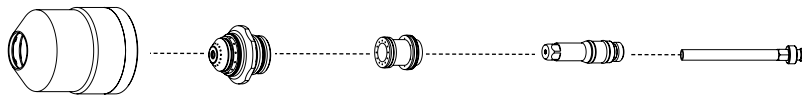

	Retaining cap*	Nozzle	Swirl ring	Electrode	Water tube
200 A	120786	120794	120853	120855	120025
400 A	120786	120856	120853	120855	120025



TECHNOLOGIES

- Chambered swirl ring™**
- CoolCore™**
- HyLife®**
- LongLife™**
- Quick disconnect**

* Retaining cap with IHS Tab 120907, retaining cap for underwater cutting 120984

HySpeed® HT4400®

Torch assembly options

Torch assembly

Description	Part number
Torch with 15' leads	128342
Torch with 10' leads	128431
Torch with 6' leads	128430

Torch

Description	Part number
Standard	120651

Additional parts available (not shown)

Description	Part number
HT4400 Instruction Manual	803580
Consumables starter kit	128497
Preventive maintenance kit (Torch, coolant, filter, coil, relay, o-rings, water tube)	228011
Nozzle wrench	004663
Electrode pit depth gauge	004630
Silicon lubricant for o-rings	027012
Electrode wrench	027102
Water tube replacement tool	027347
Bullet connector replacement kit	128654
O-ring	044028



Selected consumables are no longer available.
Contact Hypertherm for recommended alternative products

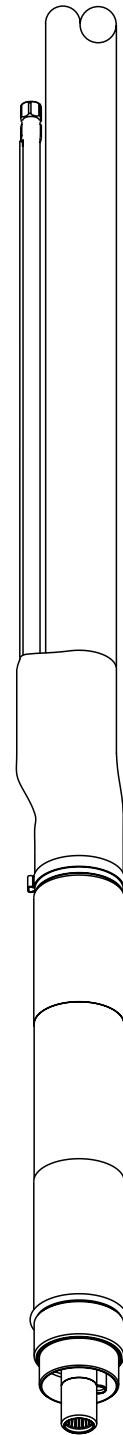

Leads



HT4400 torch

Hypertherm®

HT4001®

Consumables

O₂ – Mild steel – without slave

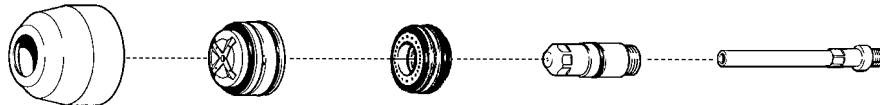

	Retaining cap*	Nozzle	Swirl ring	Electrode	SilverPlus electrode	Water tube
260 A	020579	020086	020623	020663	220397	020990
340 A	020579	020086	120135	120630	-----	020990
260 A bevel	020579	120384	020623	020975	-----	020990
340 A bevel	020579	120384	120460	120836	-----	020990

N₂ – Mild steel/Stainless/Aluminum – without slave

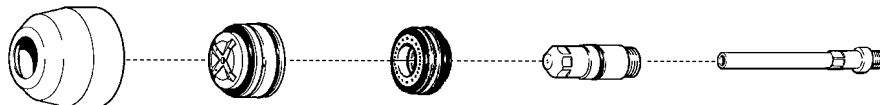

	Retaining cap*	Nozzle	Swirl ring	Electrode	Water tube
260 A	020579	020089	020039	020082	020990
400 A	020579	020084	020039	020082	020990
260 A bevel	120390	120386	020039	020968	020991
400 A bevel	120390	120387	020039	020968	020991

N₂ – Mild steel/Stainless/Aluminum – with slave

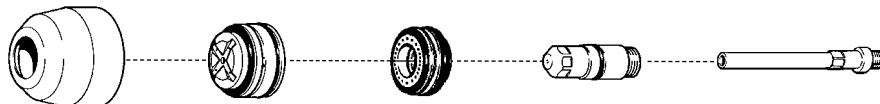

	Retaining cap*	Nozzle	Swirl ring	Electrode	Water tube
260 A	020579	020089	020039	020082	020990
400 A	020579	020084	020039	020082	020990
600 A	120390	120386	020039	020968	020990
760 A	120390	120387	020039	020968	020990
260 A bevel	020579	020089	020039	020082	020991
400 A bevel	020579	020084	020039	020082	020991
600 A bevel	120390	120386	020039	020968	020991
760 A bevel	120390	120387	020039	020968	020991

TECHNOLOGIES

Chambered swirl ring™
LongLife™

* CE countries must use CE retaining cap (please refer to operators manual for more information and part numbers)

HT4001®

Torch assembly options

Standard leads

Lead length	Part number
3 m (10')	028508
7.6 m (25')	028511
9.2 m (30')	028512
10.7 m (35')	028513
12.2 m (40')	028514
13.7 m (45')	028515
15 m (50')	028509
15.3 m (50')	028516
16.8 m (55')	028770
18.3 m (60')	028771
20 m (65')	028510

Mounting sleeves

Description	Part number
Standard	020041
Bevel	020749

Torch main body

Description	Part number
Standard	020328
Bevel	020970

Additional parts available (not shown)

Description	Part number
Torch mounting bracket	020046
Consumables starter kit (without slave, standard)	028825
Consumables starter kit (without slave, bevel)	028826
Consumables starter kit (with slave, standard)	028827
Consumables starter kit (with slave, bevel)	028828
Machine torch – Bevel (Torch, sleeve, consumables)	028741
Machine torch – Standard (Torch, sleeve, consumables)	028507
Preventive maintenance kit	228068
Electrode gauge	004147
Silicon lubricant for o-rings	027055
Water tube wrench	027347
Cap removal tool	004732
O-ring kit	025028

* CE countries must use CE retaining cap (please refer to operators manual for more information and part numbers)

 Selected consumables are no longer available.
Contact Hypertherm for recommended alternative products

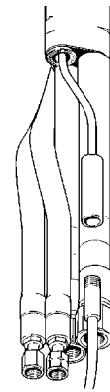

Leads



Mounting sleeve

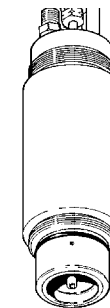

HT4001 torch

Hypertherm®

HT4000®

Consumables

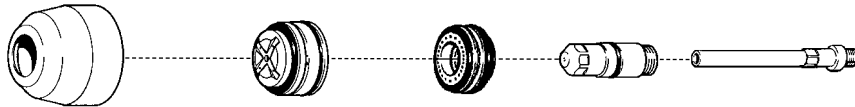

	Retaining cap	Nozzle	Swirl ring	Electrode	SilverPlus electrode	Water tube
O₂	020579	020086	020623	020663	220397	027347
Nitrogen (N₂)	020579	020084 (.166) 020089 (.120)	020039	020082		027347

Torch assembly options

Standard leads

Lead length	Part number
3 m (10')	028508
4.5 m (15')	028509
6 m (20')	028510
7.6 m (25')	028511
9.2 m (30')	028512
10.7 m (35')	028513
12.2 m (40')	028514
13.7 m (45')	028515
15 m (50')	028516

Mounting sleeves

Description	Part number
Standard	020046
IHS system sleeve	029044

Torch main body

Description	Part number
Standard	020328

Additional parts available (not shown)

Description	Part number
Torch mounting bracket	020046
Electrode gauge	004147
Silicon lubricant for o-rings	027055
Water tube wrench	027347
Electrode wrench	027001
O-ring kit	025028
Machine torch	(Torch, sleeve, consumables) 028507

Hypertherm®

HT400®

Consumables

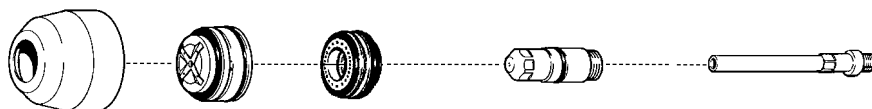

	Retaining cap	Nozzle	Swirl ring	Electrode	SilverPlus electrodes	Water tube
O₂	020579	020086	020096	020081	220397	020990
Nitrogen (N₂)	020579	020084 (.166) 020089 (.120)	020039	020082		020990

Torch assembly options

Standard leads

Lead length	Part number
3 m (10')	028137
4.5 m (15')	028138
6 m (20')	028139
7.6 m (25')	028140
9.2 m (30')	028141
10.7 m (35')	028142
12.2 m (40')	028143

Mounting sleeves

Description	Part number
Standard	020041

Torch main body

Description	Part number
Standard	020080

Additional parts available (not shown)

Description	Part number
Electrode gauge	004147
Silicon lubricant for o-rings	027055
Water tube wrench	027347
Electrode wrench	027001
Machine torch	(Torch, sleeve, consumables) 028229

Hypertherm, HyPerformance, HPR, Advanced axial swirl ring, Chambered swirl ring, Conical Flow, CoolCore, CoolFlow, HyDefinition, HyLife, LongLife, PowerPierce, SilverPlus, TrueFlow, Vented shield and HD are trademarks of Hypertherm Inc. and may be registered in the United States and/or other countries

Hypertherm®

PAC500®

Consumables

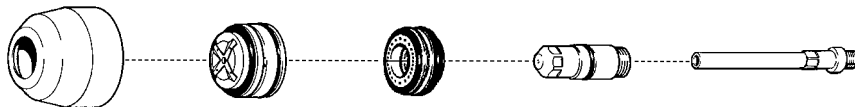

	Retaining cap	Nozzle	Swirl ring	Electrode	Water tube
Up to 600 A	020034 (Tapered)	020050 (.120)	020039	020038	120035
	020043 (Flared)	020035 (.166)			120035
		020036 (.187)			
600 – 1000 A	020034 (Tapered)	020037 (.220)	020040 (.220)	020038	
	020043 (Flared)	020047 (.250)	020048 (.250)		

Torch assembly options

Standard leads

Lead length	Part number
3 m (10')	028137
4.5 m (15')	028138
6 m (20')	028139
7.6 m (25')	028140
9.2 m (30')	028141
10.7 m (35')	028142
12.2 m (40')	028143

Mounting sleeves

Description	Part number
Standard	020041

Torch main body

Description	Part number
Standard	020030

Additional parts available (not shown)

Description	Part number
Electrode gauge	004147
Silicon lubricant for o-rings	027055
Water tube wrench	027347
Electrode wrench	027001
Machine torch – under 600 A	(Torch, sleeve, consumables) 028031
Machine torch – over 600 A	(Torch, sleeve, consumables) 028160
O-ring kit	025028

Hypertherm, HyPerformance, HPR, Advanced axial swirl ring, Chambered swirl ring, Conical Flow, CoolCore, CoolFlow, HyDefinition, HyLife, LongLife, PowerPierce, SilverPlus, TrueFlow, Vented shield and HD are trademarks of Hypertherm Inc. and may be registered in the United States and/or other countries

Mechanized upgrade products from Hypertherm



SilverPlus® electrodes

A proven technology that dramatically extends electrode life, significantly reducing operating cost.

SilverPlus technology is available for the following Hypertherm systems:

HPR® and HPR130XD®	HD3070®
HPR® and HPR260XD®	HT4001®
HPR400XD®	HT2000®
HT4400®	HT4000®
MAX200®	HSD130®

HyPro2000™ upgrade torch for HT2000® and MAX200®



HyPro2000 torch for HT2000

HyPro2000 upgrade torches provide HT2000 and MAX200 systems with faster cutting speeds and enhanced consumable life.



HyPro2000 torch for MAX200

XD technology upgrade kit for HyPerformance® Plasma HPR130® and HPR260®



Please reference page 29 for more details or contact an authorized Hypertherm sales representative.

Hypertherm®

Cut with confidence®

Environmental stewardship is a core value of Hypertherm. Extreme energy efficiency, long consumable life, and lean manufacturing lead to the use of fewer natural resources and reduced environmental impact.