











Articol	Dimensiune	Cupru	Cupru - TECU Patina	Cupru - Tecu Oxid
<b>Jgheab semirobund, 5*ml, 6 ml</b> 		cod produs 4=4ml 6=6ml	cod produs gr. 0,7 mm 3 ml	cod produs gr. 0,6 mm 3 ml
	20*	22500221		
	25	21525__15		
	28	21528__15		
	33	21533__15	22560133	22600133
	40	21540__15		

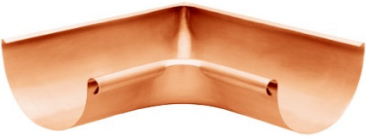

<b>Suport pt. jgheab DIN 612</b> 	Dimens. Jgheab/ latime mm x grosime mm	cod produs	cod produs	cod produs
	20/25x4	22500720		
	25/25x4	22501025		
	28/30x5	22501028		
	33/30x5	22501033	22561033	22601033
	33/30x6+5	22501433		





<b>Suport pt. jgheab DIN 612, invelit in tabla din cupru</b> 	Dimens. Jgheab/ latime mm x grosime mm	cod produs	cod produs	cod produs
	25/25x5	22501725		
	25/25x5+5	22501726		
	28/25x6	22501728		
	28/25x6+5	22501729		
	33/25x6	22501732		
	33/25x6+5	22501733		
	33/25x7+5M	22501734		
	33/25x8+5	22501833		
	40/25x6+5	22501740		
	40/25x7+5	22501839		
40/25x8+5	22501840			





<b>Suport pt. jgheab</b> 		cod produs	cod produs	cod produs
	25/25x5	22502525		
	28/25x5	22502528		
	33/25x5	22502533		
	40/25x5	22502540		





Articol	Dimensiune	Cupru	Cupru - TECU Patina	Cupru - Tecu Oxid
<b>Capac jgheab semirotund</b> 	20 25 28 33 40	cod produs 22503522 22503525 22503528 22503533 22503540	cod produs   22563533 	cod produs   22603533 
<b>Capac jgheab sfera semirotund</b> 	25 28 33 40	cod produs 22503625 22503628 22503633 22503640	cod produs 	cod produs 
<b>Colt exterior jgheab semirotund</b> 	20 25 28 33 40	cod produs 22503220 22503225 22503228 22503233 22503240	cod produs  22563233 	cod produs  22603233 
<b>Colt interior jgheab semirotund</b> 	20 25 28 33 40	cod produs 22503320 22503325 22503328 22503333 22503340	cod produs  22563333 	cod produs  22603333 
<b>Erkel vinkel 135°</b> 	25 exterior 28 exterior 33 exterior 25 interior 28 interior 33 interior	cod produs 22503425 22503428 22503433 22503426 22503429 22503434	cod produs 	cod produs 





Articol	Dimensiune	Cupru	Cupru - TECU Patina	Cupru - Tecu Oxid
<b>Racord jgheab senirotund</b> 	dimens. Jgheab/ diametru Burlan 20/60 25/60 25/80 28/80 33/80 28/100 33/100 33/120 40/100 40/120 40/150 50/150	cod produs 22504020 22504021 22504025 22504028 22504029 22504030 22504031 22504032 22504041 22504042 22504045 22504055	cod produs      22564031       	cod produs      22604031       
<b>Racord oblic</b> 	33/100	cod produs 22504253	cod produs	cod produs
<b>Racord inclinat 50°</b> 	28/80 33/100	cod produs 22504328 22504333	cod produs	cod produs
<b>Stut inclinat 50°</b>	28/80 schr. 33/80 schr. 33/100 schr. 28/80 ger. 33/100 ger.	cod produs 22504368 22504378 22504383 22504338 22504353	cod produs	cod produs

Articol	Dimensiune	Cupru	Cupru - TECU Patina	Cupru - Tecu Oxid
<b>Colector 220/220/300 mm</b> 	Diametru burlan 80 100 120 150	cod produs 22504530 22504531 22504532 22504533	cod produs  22564531	cod produs  22604531
<b>Colector cu preaplin</b> 	Diametru burlan 80 100 120	cod produs 22504520 22504521 22504522	cod produs	cod produs
<b>Lant</b> 	inele 50x5	cod produs 28561501	cod produs	cod produs

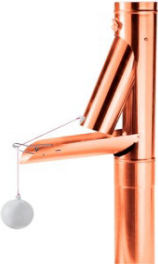

Articol	Dimensiune	Cupru	Cupru - TECU Patina	Cupru - Tecu Oxid
<b>Burlan rotund, falt interior</b> 	80 100 120 150	cod produs 2=2ml; 3=3ml; 4=4ml 21508__15 21510__15 21512__15 2250491__	cod produs gr. 0,7 mm 2 ml 22564802	cod produs gr. 0,6 mm 2 ml 22604802
<b>Burlan rotund, sudat cu mufa</b> 	60/2 m 80 100 120	cod produs 2=2ml; 3=3ml; 4=4ml 22504606 2250470__ 2250480__ 2250490__	cod produs	cod produs
<b>Cot 72° burlan rotund</b> 	50 60 80 100 120 150	cod produs 22505005 22505006 22505008 22505010 22505012 22505015	cod produs 22565010	cod produs 22605010
<b>Cot 72° burlan rotund</b> 	80 100	cod produs 22555008 22555010	cod produs	cod produs
<b>Cot 85° burlan rotund</b> 	60 80 100 120	cod produs 22505106 22505108 22505110 22505112	cod produs	cod produs





Articol	Dimensiune	Cupru	Cupru - TECU Patina	Cupru - Tecu Oxid
<b>Cot 40° burlan rotund</b> 	60 80 100 120	cod produs 22505306 22505308 22505310 22505312	cod produs	cod produs
<b>Element de soclu</b> 	80 100 120	cod produs 22505508 22505510 22505512	cod produs	cod produs
<b>Ramificatie Y 72° burlan rotund</b> 	80/80 100/80 100/100 120/100 120/120	cod produs 22506908 22506909 22506910 22506913 22506914	cod produs	cod produs
<b>Ramificatie Y 85° burlan rotund</b> 	80/80 100/80 100/100 120/100 120/120	cod produs 22506907 22506912 22506911 22506915 22506916	cod produs	cod produs
<b>Bratara pt. burlan rotund cu cui 160 mm</b> 	60 80 100 120 150	cod produs 22506006 22506008 22506010 22506012 22506015	cod produs  22566010	cod produs  22606010







Articol	Dimensiune	Cupru	Cupru - TECU Patina	Cupru - Tecu Oxid
<b>Bratara pt. burlan rotund cu cui 200 mm</b> 	60 80 100 120 150	cod produs 22506106 22506108 22506110 22506112 22506115	cod produs	cod produs
<b>Bratara pt. burlan rotund piulita cu filet M10</b> 	60 80 100 120	cod produs 22506226 22506228 22506230 22506232	cod produs	cod produs 19626010
<b>Cui pt. bratara burlan filet M10</b> 	M10/100 M10/200 M10/250 M10/300 M10/400	cod produs 22506260 22506261 22506262 22506263 22506264	cod produs	cod produs
	80 100 120 150	cod produs 22507208 22507210 22507212 22507215	cod produs	cod produs
<b>Burlan cu clapeta cu sita</b> 	80 100 120	cod produs 22506308 22506310 22506312	cod produs	cod produs

Articol	Dimensiune	Cupru	Cupru - TECU Patina	Cupru - Tecu Oxid
<b>Burlan cu clapeta</b> 	60 80 100 120	cod produs 22506506 22506508 22506510 22506512	cod produs	cod produs
<b>Burlan cu clapeta</b> 	80 100 120	cod produs 22506718 22506720 22506722	cod produs	cod produs
	100/100 120/120	cod produs 22506740 22506742	cod produs	cod produs
<b>Burlan colector pt. furtun</b> 	80 100 120	cod produs 22506748 22506750 22506752	cod produs	cod produs
<b>Parafrunzar</b> 	80 100 120 150	cod produs 22506808 22506810 22506812 22506815	cod produs	cod produs



Articol	Dimensiune	Cupru	Cupru - TECU Patina	Cupru - Tecu Oxid
<b>Adaptor teava canal</b> 	80/115 100/115 100/150 120/150 120/180	cod produs 22507009 22507010 22507011 22507012 22507013	cod produs	cod produs
<b>Element de ventilare</b> 	gauri D 5 mm perforare 40%	cod produs 22531001	cod produs	cod produs
<b>Gura de aerisire</b> 	80 100 120 150	cod produs 22531008 22531010 22531012 22531015	cod produs	cod produs

Articol	Dimensiune	Cupru	Cupru - TECU Patina	Cupru - Tecu Oxid
<b>Jgheab dreptunghiular DIN 612</b> 	20 25 33 40	cod produs 22510120 22510125 22510133 22510140	cod produs  22567103	cod produs
<b>Suport pt. jgheab DIN 612</b> 	Dimens. Jgheab/ latime mm x grosime mm 20/25x4 25/25x5 33/30x6	cod produs 22511520 22511525 22511533	cod produs  22567113	cod produs
<b>Suport pt. jgheab DIN 612  invelit in tabla</b> 	Dimens. Jgheab/ latime mm x grosime mm 25/25x5+5 33/25x6+5 40/25x7+5	cod produs 22511725 22511733 22511740	cod produs	cod produs
<b>Capac jgheab dreptunghiular</b> 	20 25 33 40	cod produs 22513520 22513525 22513533 22513540	cod produs  22567135	cod produs
<b>Colt jgheab dreptunghiular  interior/exterior</b> 	20 25 33 40	cod produs 0=exterior 1=interior 22513__20 22513__20 22513__20 22513__20	cod produs 6=exterior 7=interior  2256713__20	cod produs

Articol	Dimensiune	Cupru	Cupru - TECU Patina	Cupru - Tecu Oxid
<b>Racord</b> jgheab dreptunghiular *iesire rotunda 	20/60 25/80 33/100 40/120	cod produs 22514020 22514025 22514031 22514042	cod produs  22567141	cod produs
<b>Burlan</b> dreptunghiular, 4 ml 	80x80 100x100 120x120	cod produs 22514614 22514714 22514814	cod produs	cod produs
<b>Cot 72°</b> burlan dreptunghiular 	80x80 100x100	cod produs 22515008 22515010	cod produs	cod produs
<b>Bratara</b> burlan dreptunghiular 	80x80 100x100 120x120	cod produs 22516008 22516010 22516012	cod produs	cod produs
<b>Jgheab culcat</b> semirotund 	670	cod produs 22500565	cod produs	cod produs
<b>Suport</b> pt. jgheab culcat 	Gr. 4/20x6 Gr. 4/25x8	cod produs 22502702 22502704	cod produs	cod produs

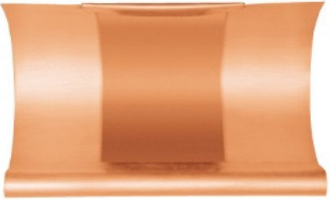
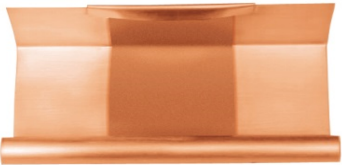
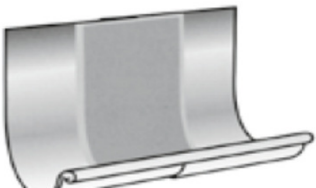
Articol	Dimensiune	Cupru	Cupru - TECU Patina	Cupru - Tecu Oxid
<b>Rost de dilatare 3 ml</b> 	3000	cod produs 27541430	cod produs	cod produs
<b>Rost de dilatare pt. jgheab semicircular</b> 	25 28 33 40	cod produs 27540525 27540528 27540533 27540540	cod produs	cod produs
<b>Rost de dilatare pt. jgheab dreptunghiular</b> 	25 33 40	cod produs 27540625 27540633 27540640	cod produs	cod produs
<b>Rost de dilatare pt. jgheab culcat</b> 	500 650 800	cod produs 27540750 27540765 27540780	cod produs	cod produs

Dimensiunea jgheburilor conform normativ DIN EN 612:

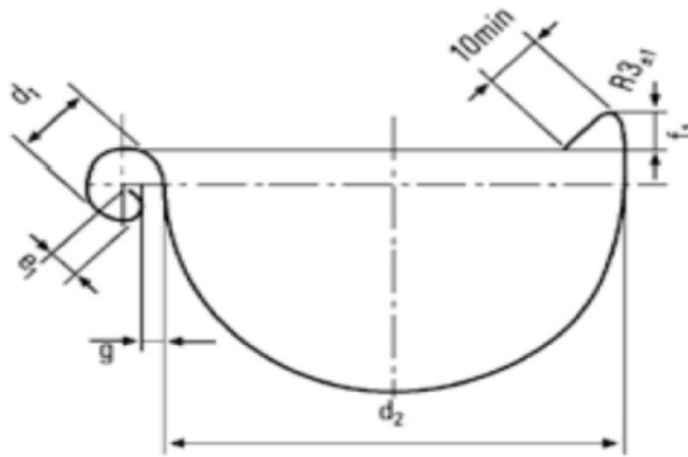

Dimensiune	Latime desfasurata toleranta +1/-2 mm	d <sub>1</sub> +1/-1 mm	d <sub>2</sub> +20 mm	e <sub>1</sub> +2/-1 mm	f <sub>1</sub> mm	g mm	Grosime material					Suprafata interioara cm <sup>2</sup>
							Al	Cu	St	Zn	S.S	
200	200	16	80	6	8	5	0,7	0,6	0,6	0,65	0,4	25
250	250	18	106	7	10	5	0,7	0,6	0,6	0,65	0,4	43
280	280	18	127	7	11	6	0,7	0,6	0,6	0,7	0,4	63
333	333	20	153	9	11	6	0,7	0,6	0,6	0,7	0,4	92
400	400	20	192	9	11	6	0,8	0,7	0,7	0,8	0,5	145
500	500	20	250	9	21	6	0,8	0,7	0,7	0,8	0,5	245

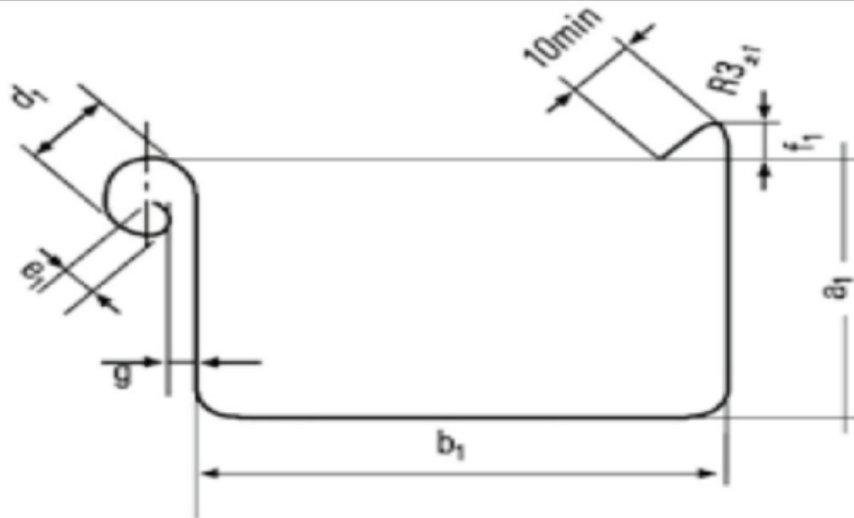

Dimensiune	Latime desfasurata toleranta +1/-2 mm	a <sub>1</sub> +1/-1 mm	b <sub>1</sub> +1/-1 mm	d <sub>1</sub> +2/-1 mm	e <sub>1</sub> mm	f <sub>1</sub> min. mm	g mm	Grosime material					Suprafata interioara cm <sup>2</sup>
								Al	Cu	St	Zn	S.S	
200	200	42	70	16	5	8	5	0,70	0,60	0,60	0,65	0,40	25
250	250	55	85	18	7	10	5	0,70	0,60	0,60	0,65	0,40	43
333	333	75	120	20	9	10	6	0,70	0,60	0,60	0,70	0,40	92
400	400	90	150	20	9	10	6	0,80	0,70	0,70	0,80	0,50	145
500	500	110	200	20	9	20	6	0,80	0,70	0,70	0,80	0,50	245