

Electric fencing solution



Lanstar® 兰星
Professional Makes Perfect

Lanstar® 兰星

SHENZHEN LANSTAR TECHNOLOGY CO.,LTD

Add: 3/F,8 Block,Lijincheng Industrial Park,East Rd of Industry
Longhua Street,Bao an District,Shenzhen,China.

Post code:518109

Tel: (+86) -755-89390825/89392855

Fax: (+86) -755-22705858

Email:sales1@electrofence.cn

www.lanstar.net (CN/Spanish)

www.electrofence.cn (English)

 **CE** ISO 9001:2008
NO:04110020095R0S

Since 2002



Company Introduction

Shenzhen Lanstar Technology Co., Ltd is a leading electric fence supplier in China with excellent technology and products, which are approved by ISO 9001, CMA by China security department and CE certificate.

Dedicating to provide best quality products, professional security solution and customized services, Lanstar has offered perimeter security service to thousands of companies and governments in more than 20 provinces at domestic market. Besides, our products are distributed to more than 40 countries worldwide. We are a reliable electric fence supplier at home and broad.

Strong research team guarantees the world-class technology and industry-leading developed potential. At the same time, our investment in R&D pay off: several breakthrough has achieved in technology.

Products ranging from perimeter security fencing system to agricultural farm fencing system, we aim to be a top international security enterprise, and provide professional service to all over the world.

We are looking forward to being your reliable partner.





Electric fence energizer

Perimeter security single zone electric fence energizer, generates high voltage pulse of 5KV~15KV to intruders touching the fence, which establishes a physical and psychological barrier to prevent invasion.

Feature:

1. Differential voltage output technology: every wire has voltage, have the differential voltage between the two adjacent wires.
2. LCD or LED indicate the working state and the voltage on every wire of fence.
3. High / low voltage switch manually, long-distance equipment auto switch function.
4. Short circuit, break and tamper alarm, self-inspection system for equipment fault
5. Waterproof casing and downward appearance design leading the industry development.
6. RS 485 bus control, keypad, computer, network and multiple long distance management solution.
7. DC12V, NC/NO dry contact alarm output, can conjunct with other modern security products.
8. Set up alarm delaying triggered time freely



LX-2008SC



LX-2008SE

Output parameter:

1. Output peak voltage: 5KV~10KV
2. Output low voltage: 700~1000V
3. Peak current of pulse: <10A
4. Pulse duration: $\leq 0.1s$
5. Pulse interval time: 1s
6. Max quantity of electricity of pulse: 2.5mC
7. Max energy of pulse: <5.0J



LX-2008HC



LX-2008HE

Output parameter:

1. One for ultra high voltage output
2. Output peak voltage: 5KV~15KV
3. Output low voltage: 700~1000V
4. Peak current of pulse: <10A
5. Pulse duration: $\leq 0.1s$
6. Pulse interval time: 1s
7. Max quantity of electricity of pulse: 2.5mC
8. Max energy of pulse: <5.0J



LX-M8J



LX-M4J

Electric fence keypad controller

Description:
Keypad controller for electric fence security system, controlling up to 16 zones at the same time. It can set up and cancel the defence zones immediately instead of setting up every energizer.

Feature:

1. Password logging and password modifying function
2. Control 1~16 zones of electric fence energizer by RS485 bus
3. Alter zone numbers (ID) of electric fence energizer
4. Alarming zones, types (short circuit and break), time record function
5. DC12V alarm signal output (LX-M8J only)

Middle pull post(LX-CGF)
Middle pull post (rod), Made of fiberglass, fence stake, is made of fiberglass Which holds the the wire of the electric fence
1. Keep the space of fence wire
2. Made of fiberglass Tensional and corrosive proof, water proof
3. Provide enough tension for electric fence and terminal post
4. Installed on every 4-6 meters

Terminal post(LX-DGG)
Terminal post(terminal rod), installs on the two end, the corner angle less than 120 degree the electric fence, which holds the pressure and tension from the electric wire
1. Made of stainless steel, more durable
2. Installed every 50-100 meters, the corner, the end of fence
3. Anti-corrosive
4. Standard length of 850*380*380*15mm, custom-made any length

Terminal post insulator(LX-DJ)
Terminal post insulator is widely installed on terminal posts, connecting terminal post and electric wire by fixing
1. High voltage resistant of 15KV
2. Anti-oxidation, corrosion resistance and anti-static
3. Made of ABS material, more durable

Middle pull rod insulator(LX-CJ)
This insulator is used to hold the wire and reduce the the pressure of middle pull post or line posts, using latch (pin) to fix the insulator
Easily installation
1. High voltage resistant > 15kv
2. Anti oxidation, Anti-static
3. Corrosion resistance
4. Easy installation

Wire tensioner(LX-J)
Electric fence wire tensioner, penetrated with the alloy wire, available in changing the tension of the alloy wire
1. Compound material
2. Installed on every alloy wire of terminal post
3. Anti corrosion and anti-oxidation

Wire-wire linker(LX-X)
Wire linker(wire connector), is used in connection between high voltage wire and alloy wire, fixed on the terminal posts
1. Aluminum made, anti-oxidation
2. Easy to install, light weight
3. Double threaded, prevent from loose of the wire

Post fixation(LX-ZD)
Fixation for electric fence security system middle posts, and middle pull posts, which can fix the posts on floor and wall
1. Anti corrosion and high tensile
2. Stainless steel made
3. Fix the posts and universal pedestal

Universal pedestal(LX-DZ)
Universal pedestal, applicable in holding terminal post, middle pull post on the wall in perimeter security system.
1. Made of stainless steel
2. Fastening terminal posts, middle pull posts, and middle posts
3. Rust proof and high tension
4. Installed every 22.5 degree, angle adaptable

Terminal post fixing clip(LX-DD)
Description: The fixing clip penetrates the terminal post insulator, and is fixed on terminal post or U groove, connecting the terminal post and insulator
Feature:
1. Made of stainless steel, more durable
2. Rust proof

Voltmeter(LX-CLB)
Easily detect the voltage on electric fence or voltage between earth and electric fence, and show the value on the LCD screen.
1. Voltage range detected from 1000 to 10,000 voltage
2. Low consumption, power saved
3. Automatic off / on, Replaceable 9v battery

Lightning arrester(LX-HY5WS)
Protecting the fence energizer from lightning strikes(thunder) on the fence perimeter.
This lightning arrester creates a path of least resistance, diverting lightning surges to the ground
Must separate with energizer grounding system with more than 10 meters distance

Gate Connector(LX-GC)
Used for sliding gate.
Made of plastic-steel and stainless steel, suitable for outdoor use

Luminated Warning sign(LX-JS)
Warning sign should be hung on the electric fence to indicate there is electric shock on the fence and give a psychological barrier to intruders. Luminated warning sign, can be seen during the night with double printed black letters.
1. Large black letters on both sides
2. Indicate electric shock with picture and words
3. Installed every 10 meters on the fence
4. Luminate 10 hours of absorbing light for 10 minutes

Siren(Audible and visual alarm)(B0478)
High bright
High transparency
Fadeless
Low noise

Siren(speaker)
Description: Siren is being used very widely in perimeter security system, especially in electric fence security system
It will release a loud noise to indicate intruders for admin to know where invasion happens
Working voltage: DC12V

Energizer Protective Housing(LX-FHX)
435*350*150mm fan or temperature switch optional, Made of metal

Alloy wire(Φ1.8/2.0/2.5mm)
Electric fence alloy wire, specially made wire for electric fence security system, conducting electricity from the energizer to perimeter. The maximum tension is about 600N, preventing continuous electric shock
1. Good conducting, low impedance
2. High elastic, oxidation resistant, anti corrosion
3. Three dimension: 1.8mm, 2.0mm, 2.5mm

High voltage cable(LX-20)
Double insulated high voltage cable, is used to connect the energizer and terminal post to conduct the electric shock
1. Double insulated, resistant of 20KV high voltage pulse
2. 2.5 square millimeter aluminum conductor

Multifunctional (Internet) Control Solution



System Diagram

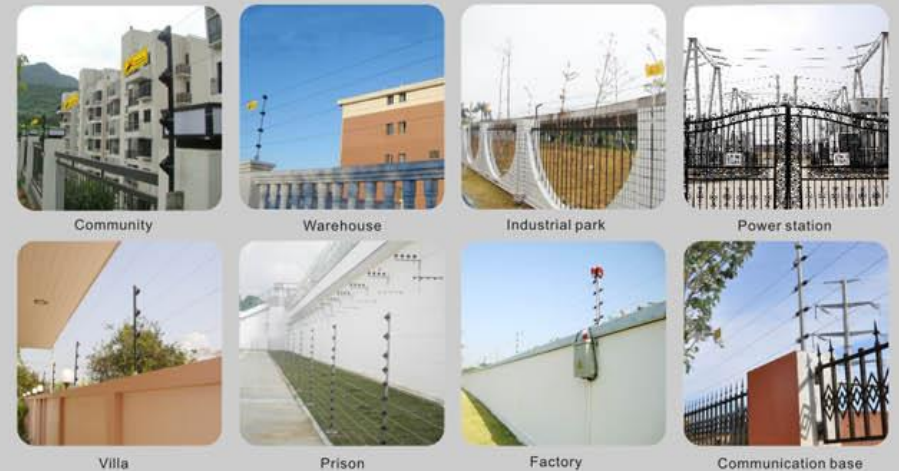
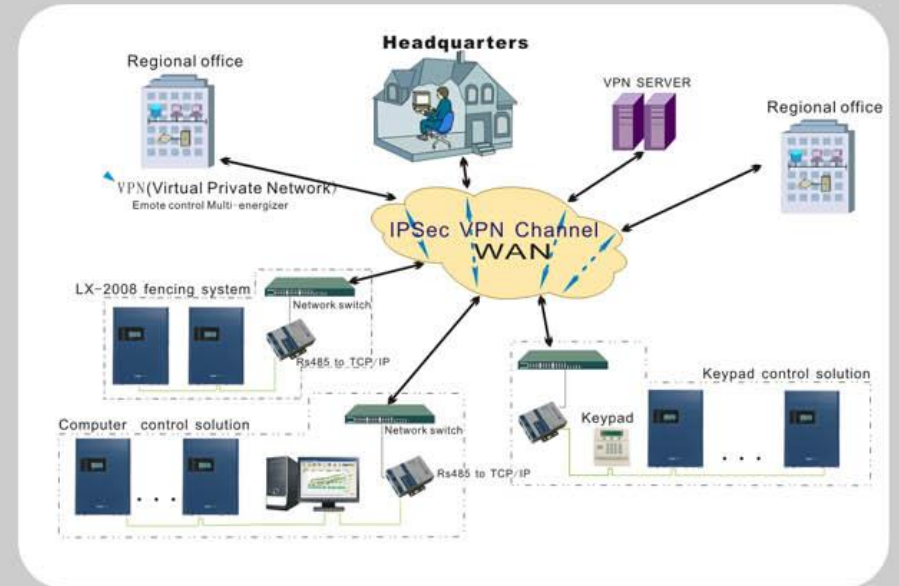
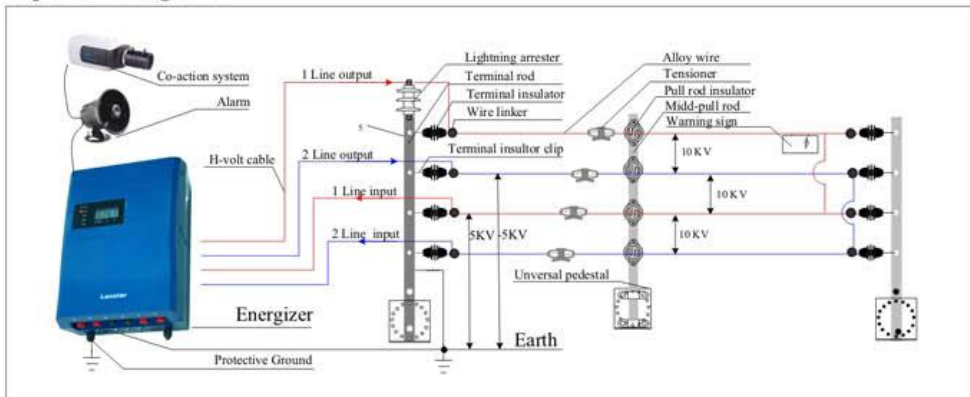



Animal fencing energizer

LX-Polar II Electric Fence Energiser

Generating the electric shock to the fence wire. Meets the needs of all animal management or protection and rotational crop grazing requirement. It is easy to install and the power options include AC(110v-240v) mains power, 12 volt (v) deep cycle lead-acid/gel battery or in conjunction with a (10-60 watt) solar panel, making this a suitable system for larger scale settings where mains power is either unavailable or impractical. As a combination, fixed or portable system, the Electric Fence Energiser provides flexibility with pasture management and is the ideal solution for short or long-term animal control or rotational crop grazing.

Generating the electric shock to the fence wire. Meets the needs of all animal management or protection and rotational crop grazing requirement. It is easy to install and the power options include AC(110v-240v) mains power, 12 volt (v) deep cycle lead-acid/gel battery or in conjunction with a (10-60 watt) solar panel, making this a suitable system for larger scale settings where mains power is either unavailable or impractical. As a combination, fixed or portable system, the Electric Fence Energiser provides flexibility with pasture management and is the ideal solution for short or long-term animal control or rotational crop grazing.

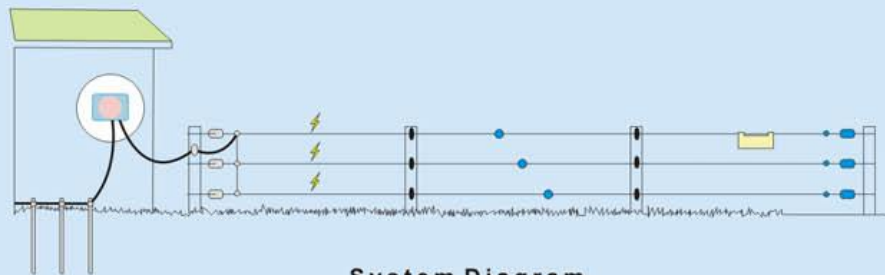

System Diagram

Main features include:

1. Large terminals that make it easy to connect for best performance
2. Powered by:
 - a) AC mains power or
 - b) 12v deep cycle lead-acid/gel battery (not included)
 - c) 40w solar panel (not included) in conjunction with a 12v battery
3. 6 operating modes including a cost-effective day/night power save
4. 2 different pulse intervals of 1.5 seconds and 2.5 seconds (Switchable)
5. LCD/LED display shows the pulse voltage and status of the fence and battery
6. Waterproof and dustproof



LX-Polar 2



LX-Polar 5



LX-Polar S1



LX-Polar S2



LX-Polar S5

Fence energizer
 Model : LX-polar I (S1)
 Performance Characteristics
 1. Working distance of single wire fence is up to 5,000m (theoretical value)
 2. Stored energy: 1.5 joules
 3. Max Output energy: 1.0 joules

Fence energizer
 Model : LX-polar II (S2)
 Performance Characteristics
 1. Working distance of single wire fence is up to 20,000 (theoretical value)
 2. Stored energy: 2.7 joules
 3. Max Output energy: 2.0 joules
 4. Consumption: 3.5 W

Fence energizer
 Model : LX-polar 5 (S5)
 Performance Characteristics
 1. Working distance of single wire fence is up to 30,000 (theoretical value)
 2. Stored energy: 5.6 joules
 3. Max Output energy: 5.0 joules
 4. Consumption: 5.5 W



Tread in post

Tread in post Posts have a solid cuspidal "I" pin for rigidity and an extended, reinforced high-tensile steel spike to push into the ground with your foot and has eight molded clips to hold fence wire or rope or tape

1. Convenience for installation and dismantle
2. Light weight and waterproof, anti-corrosion
3. Cost effective
4. Suits for temporary fence

Gate Handle(LX-GH)

Make a fast and effective gateway for electric fencing, easy access to the fenced off paddock, which allows opening without ground contact, made of UV plastic insulated clip and galvanized high tension spring.

1. Insulated grip with UV stabilised plastic
2. Connect the spring and insulator to build up a gate
3. Galvanised, non-turning hook
4. Insulated handle for safety

Terminal Insulator(LX-TI)

Terminal posts or corner posts terminal insulator, installed on terminal posts, connecting terminal post and alloy wire, grooves to prevent twisting and stand tension

1. Resist 15KV high voltage
2. Made of ABS, cost effective
3. Withstand the tensile from the electric fence wire

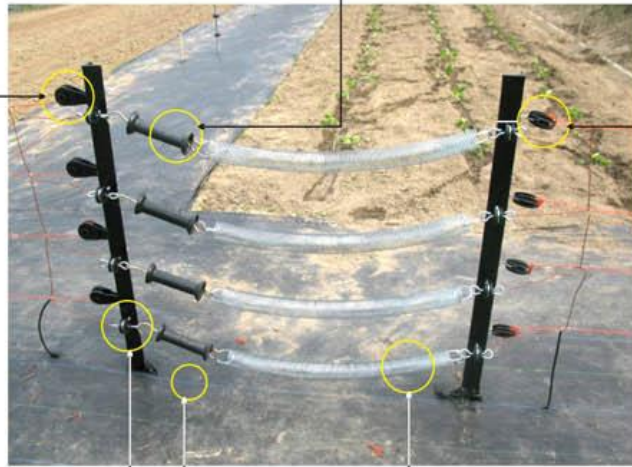

Inline Strainer(ratchet tensioners) LX-IS

used in farm livestock electric fence system, used in one end of the fence wire, to tension the polywire or polytape, poly rope

1. Can be tightened with a square screwdriver
2. Easily control the length of electric fence wire
3. Cost effective with good quality
4. Insulated

Double Hook Insulator(LX-DHIB)

Description: Insulator used in gate handle, one loop holds the fence while the other holds the gate handle

Feature:

- Used with Any Gate Handle
- Attached to post by screw nut
- Used with any gate handle
- Tapping thread, easily to install

Polywire(LX-PW0xx)

Visible and safe polywire conducting electricity from the energizer, contain 3-9 stainless steel conductors for greater strength and conductivity, multiple diameter and color for your difference application, temporary fencing or permanence fencing, Easy to install, re-wind and re-use, more cost effective and light weight

1. Diameter: 2.0 to 6.0mm
2. Easy to install, re-wind and re-use
3. Can be used for temporary grazing, strip or rotational grazing and pet control
4. Visible and safer than traditional metal wire

Gate Spring(LX-GS)

Electric fencing gate spring, galvanised, extending up to 5 meters without overstretching

Complete with the gate handle to be an extremely visible and highly effective gate

Complete with double hoop insulator

1. Made of galvanised
2. Extendable up to 5 meters
3. Easy to install



Ring Insulator(LX-RIT)

Insulator screw in ring (self tapping screw/tapping screw), simply screw into soft wood to prevent electrical shorts between the electrified wire and the fence posts

Keep the space between wires and post

1. Has an angled slot (clips) that ensures wire retention
2. Work with wire and polyrope
3. Suitable for all steel and portable wire products
4. Extremely versatile and useful insulator

Double hook Insulator(LX-DHIT)

Insulator used in gate handle, one loop holds the fence while the other holds the gate handle

Used with Any Gate Handle

Attached to post by (self tapping) screws

Used with any gate handle

Tapping thread, easily to install

Ring Insulator (bolt)-(LX-RIB)

Ring Insulator with Rope, Suitable for Twine or Permanent Wire

Easy to use with rope and wire

Suitable for twine or permanent wire

Simply screw into wooden post or normal screw plug insertion to attached concrete or brick wall or metal post with exiting holes

Feature:

1. Has an angled slot (clips) that ensures wire retention
2. Work with wire and polyrope
3. Suitable for all steel and portable wire products
4. Extremely versatile and useful insulator



warning signs (LX-ZJS)

Warning sign is used to hang on the electric fence to indicate electric shock to people.

Feature:

1. large black letters printed on both sides
2. 200x100 mm, light weight



Voltmeter(LX-CLB)

Easily detect the voltage on electric fence or voltage between earth and electric fence, and show the value on the LCD screen.

1. Display the voltage with number on LCD screen
2. Easily and effectively detect voltage between two different points
3. Voltage range detected from 1000 to 10,000 voltage
4. Low consumption, power saved
5. Automatic off/on, Replaceable 9v battery



Solar Panels (LX-SP)

Convert the sun light (solar irradiance) directly into electricity to supply the electric fence energizer in areas hard to access of Mains power, they are now the practical and cost effective, efficient, low maintenance method

1. Mono & polycrystalline
2. Max. Power (Pm) 10W/20W/30W/40W/60W
3. Operating Voltage (Vpm): 12 to 18V
4. Module Operating Temperature: -45°C to +85°C
5. Performance Tolerance ±5%



high voltage lightning arrester (farm)(HY5WS-17)

Installing on the terminal post, and minimising the damage to electric fence energizer from the thunder and lightning

1. Must connect to the grounding system one side
2. Install on each energizer with 1 arrester

Rod Post Insulator(LX-RPI)

Three tap position Adjustable to fit posts 0mm to 20mm in diameter

Use with all fence wire and poly rope keep the distance within the electric fence wires

Material: PE

Can work with various size posts

Hand up wire/tape/rope

Keeps distance between lines

Diameter ranging from 0 to 20mm



Solar controller(LX-SC)

The product can automatically manage the work of Solar Panel and battery in Solar System



Typical solutions:

- If the conductivity of ground is not good because of dry soil or sand, the pulse circuit will not form even when animal touches the wire.
- Then we make adjustment of fixing the earth wire to bars also. By doing so, the system could work as efficiently as it does in common cases. Besides, the line design will vary greatly due to animal height, weight, and trait difference, please check below typical line design for different animals.

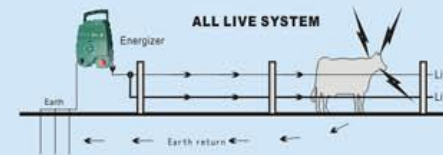

Ground connection

Stick two steel bars into ground, make sure the length between two bars is more than 30 cm, then connect the black ground icon with one bar and connect the red pulse icon with the other. Put on the power and choose the 1.5 second mode. If the right number is less than 4 kv, the ground connection is good.

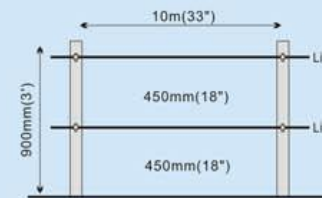

Solution for horse and cow:



Sticker bar is necessary if the length between two adjacent bar is around 15- 20 ms.

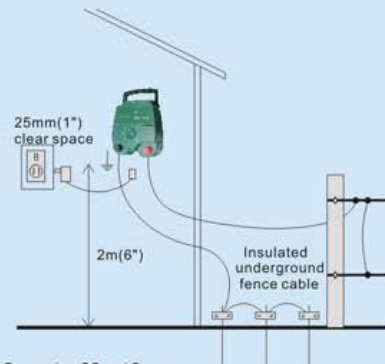

Installation

Indoor installation:

- 1) A appropriate place for fixing the energizer;
- 2) Out of touch of children and animals
- 3) Link the black grounding icon with clip to ground;
- 4) Link the red pulse output icon with clip to wire;
- 5) Connect with transformer and choose the mode;

Notice: the power adapter could replace the battery to provide power to energizer, if the customer do not have special requirement.

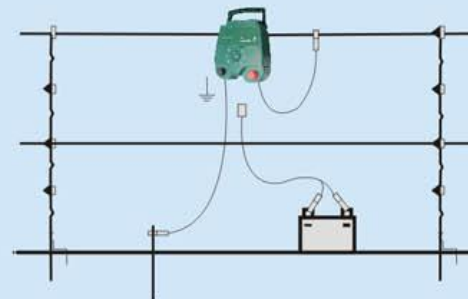

Outdoor installation:

- 1) In most cases, the energizer should be fixed on the wooden bar
- 2) Link the black grounding icon with clip to ground;
- 3) Link the red pulse output icon with clip to wire;
- 4) Connect with transformer and choose the mode;

Notice: the energizer could be powered by lead-acid, 12V DC or solar panel

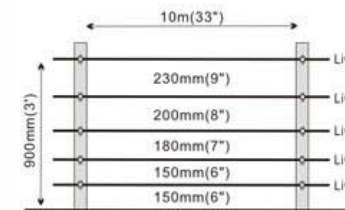

Solution for goat, poultry animals

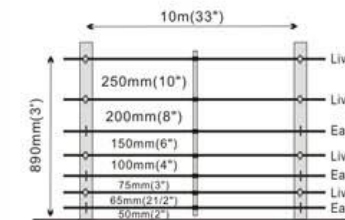
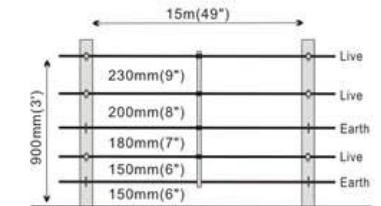

Solution for fierce animals:

